



LIGHTS
ON

BIG WHITE 2020

THIS IS WHAT WE STAND FOR.



PRICE AND PERFORMANCE
IN PERFECT HARMONY



QUICK AND
RELIABLE DELIVERY
24hrs. (GERMANY), 48hrs. (EUROPE)



WE ARE YOUR WAREHOUSE
98% AVAILABILITY



5 YEAR WARRANTY*

SALES INTERNATIONAL

Telephone number:
+49 (0) 2451 4833 - 355

Fax number:
+49 (0) 2451 4833 - 179

E-mail:
export@slv.de

Monday to Thursday:
08:00 hrs. – 18:00 hrs.

Friday:
08:00 hrs. – 17:00 hrs.

TECHNICAL CUSTOMER SERVICE

Telephone number:
+49 (0) 2451 4833 - 600

Fax number:
+49 (0) 2451 4833 - 519

E-mail:
service@slv.de

Monday to Thursday:
08:00 hrs. – 17:00 hrs.

Friday:
08:00 hrs. – 14:30 hrs.

HEAD OFFICE

SLV GmbH
Daimlerstraße 21-23
D-52531 Übach-Palenberg

Telephone number:
+49 (0) 2451 4833 - 0

Monday to Friday:
08:00 hrs. – 17:00 hrs.

slv.com

LOGISTICS CENTRE

SLV GmbH
Werkstraße 8-10
D-52531 Übach-Palenberg

CUSTOMER SATISFACTION

SLV strives with excellent customer service and performance in execution and delivery towards to fulfilling and exceeding your expectation! Our dedicated team is available for you personally!

Call us (+49 (0) 2451 4833 - 355), contact us by email (export@slv.de) or order directly at our website slv.com. We are looking forward to enlighten your project!

CUSTOMER INFO

Please also note our return guidelines and repair conditions, which can be found on our website at slv.com/en-de/service/downloads.

Provided that no other agreements exist, our general business terms and conditions apply to all deliveries and services. These can be found on our website at slv.com/en-de/general-terms-and-conditions.

*Please note the warranty conditions under slv.com – Service → Downloads → Warranty Conditions.



**SLV
VALETO®**



© bernardbodo, Adobe Stock

COMPATIBLE WITH OTHERS. CONNECTED WITH YOU.

The SLV VALETO® SMART LIGHT SYSTEM makes your life easier. You can connect the system to Philips Hue, OSRAM SMART+ and other ZigBee® 3.0-compatible systems from other manufacturers and control them using voice commands with the aid of Amazon Alexa.

All of the options and benefits from page 816 onwards.

LET'S GO DIGITAL SO THAT YOU CAN WORK MORE EFFICIENTLY

“AND WHAT EXACTLY CAN THE NEW WORKSHOP DO NOW?” A GREAT DEAL!



During the reorientation, it was not just about making the web site look good. Performance was also an issue. Not only has the display of our products been improved, but also the search results. A faster page set-up and more intuitive operation were other requests that we have incorporated. Of course, all of this has not just been optimised for desktops but also for Smartphones and tablets.

SEARCH & FIND

A product search is essential in a web shop. For this reason we have paid special attention to this area. Meaningful filters and a multitude of internal and external suggestions have been interwoven with the technical possibilities of clever search algorithms here. The results are therefore not only displayed more quickly but also in a better way – in a nutshell: the search is more efficient

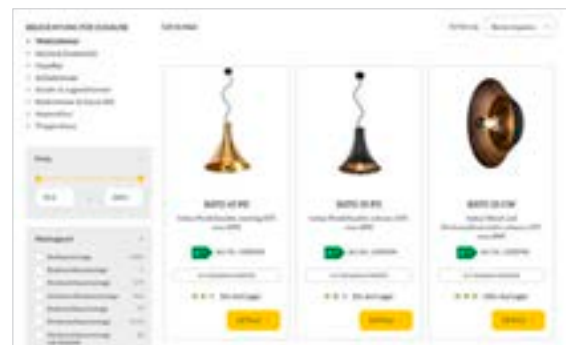

YOUR VISION – OUR LUMINAIRES



Light is equally as diverse as the people that deal with it. This is also reflected in different projects. In order for these to become reality, we provide you with all of the tools and information that you need. Regardless of whether you prefer certain software or need a certain energy label: We would be pleased to provide the necessary information.

VIEW ONLINE

You have probably already got to know our 300 page catalogue. If not, we would like to take the opportunity to show you the advantages again. You will find a short video guide under the QR code. Just take a look!





INDOOR 006 - 527



Table lamps and floor stand 006 - 031
 Pendants 032 - 131
 Wall lights 132 - 229
 Ceiling lights 230 - 277
 Wall and ceiling lights 278 - 329



240V track, 3-circuit..... 330 - 373
 240V track, D-track..... 374 - 381
 240V track, 1-circuit..... 382 - 405
 240V track Easytec® II..... 406 - 415
 Low-voltage cable system and glass cabinet track..... 416 - 433



Recessed fitting 434 - 527

OUTDOOR 528 - 735



Mobile luminaires and floor stand 528 - 583
 Spots..... 584 - 609
 Wall lights 614 - 671
 Ceiling lights 672 - 679
 Wall and ceiling lights 680 - 681



Recessed wall lights..... 696 - 701
 Recessed ceiling lights..... 702 - 711
 Inground fitting 712 - 735

SAFETY SOLUTIONS 736 - 745



Safety solutions..... 736 - 745

PROFILE SOLUTIONS 746 - 777



LED STRIPS AND LIGHT BARS 778 - 815



LED strips..... 782 - 812
 Light bars 813 - 815

SLV VALETO® SMART LIGHT SYSTEM | SLV LIGHT CONTROLLERS 816 - 841



SLV VALETO® SMART LIGHT SYSTEM..... 816 - 825
 SLV LIGHT CONTROLLERS Overview 826 - 827
 SLV COLOR CONTROL 828 - 831
 SLV KELVIN CONTROL 832 - 834
 SLV BLUETOOTH® CONTROL 835
 SLV CONTROL BY TRUST 836 - 841

ACCESSORIES 842 - 865



Accessories 842 - 865

LAMPS 866 - 881



Lamps 866 - 881

LUMINAIRE FAMILIES AND INDEX 882 - 918



The SLV luminaire families 882 - 899
 Numerical 900 - 911
 Alphabetical 912 - 917

Other luminaires and variants can be found online at www.slv.com

All prices specified are recommended retail prices (RRP) excluding VAT.

TIMELESS CLASSIC

SUITABLE TABLE LAMPS AND FLOOR STANDS
FOR ANY ROOM.

The classic among the luminaires: our table lamps and floor stands blend into any interior thanks to their simple, slim design and therefore always make a good impression in offices, living areas and stores.

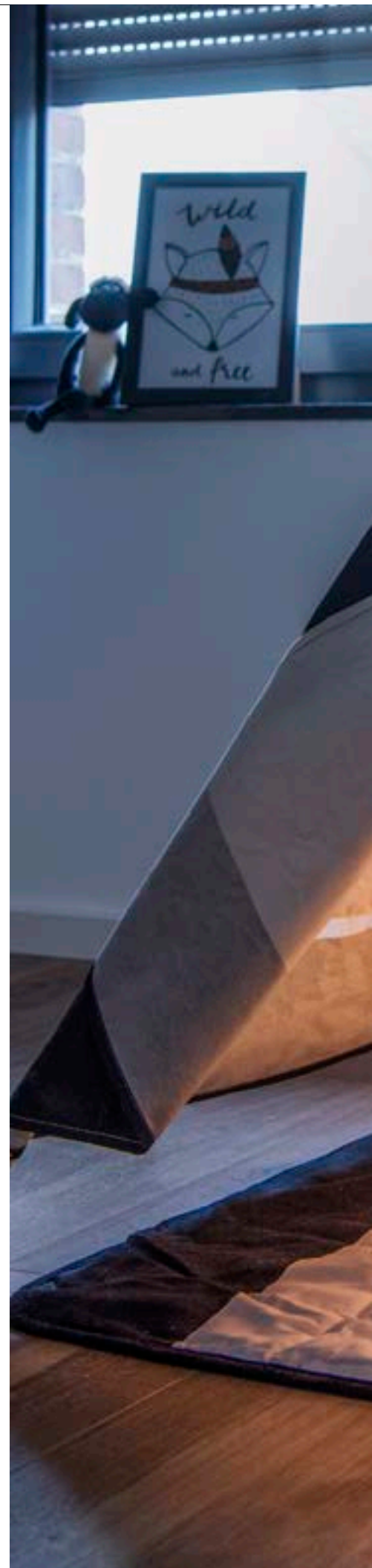



1002582 11

1002583 11

















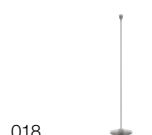



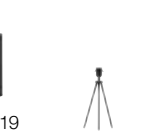





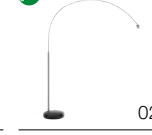



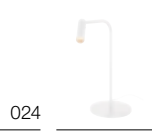

1002146 29

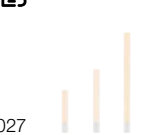

1003029 + 156122 22 + 22

TABLE LAMPS AND FLOOR STANDS

 010	 010	 011	 012	 012	 015	 018	 018
 018	 019	 019	 019	 020	 020	 020	 021
 021	 021	 022	 022	 022	 024	 024	 025
 025	 026	 026	 027	 027	 028	 029	 030
 031							

 Other luminaires and variants can be found online at www.slv.com

KALU
FL, single, QPAR111



E-A++ Range A++-E

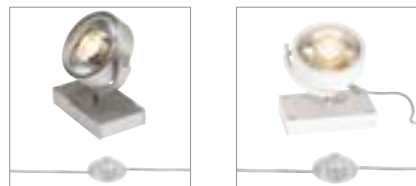

- Luminaire unit, can be rotated by 350° and swivelled by 90°
- Foot switch on connection lead

Product details

220-240V ~50/60Hz
Material: Aluminium

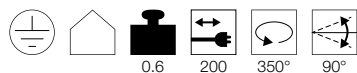

Dimensioned drawing

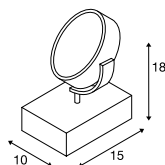

Note

Shock-proof 2-pin plug and switch

Recommended lamp

LED GU10 6.5W 30°
2700K 400lm EEL=A+
7kWh/1000h
Item no. 1000684



LED GU10 15.5W 30°
2700K 680lm EEL=A
6kWh/1000h
Item no. 570672



Lamp details

max. 20W QPAR111

Variant	Item no.
GU10 QPAR111	
■ black	1000722
□ white	1000723
■ matt aluminium	1000724

FITU
TL, E27



E-A++ Range A++-E



- Switch on connection lead

Product details

220-240V ~50/60Hz
Material: Aluminium



Dimensioned drawing

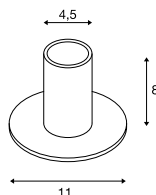

Note

2-pin plug and switch

Recommended lamp

E27 8W
2000-2900K 500lm EEL=A
8kWh/1000h
Item no. 560741



LED E27 8W 350°
2200K 250lm EEL=B
8kWh/1000h
Item no. 1001357



Lamp details

max. 10W

Variant	Item no.
E27	
■ black	1001676
E27	
□ white	1001677
E27	
■ aluminium	1001678



1000722 10



1001676 10

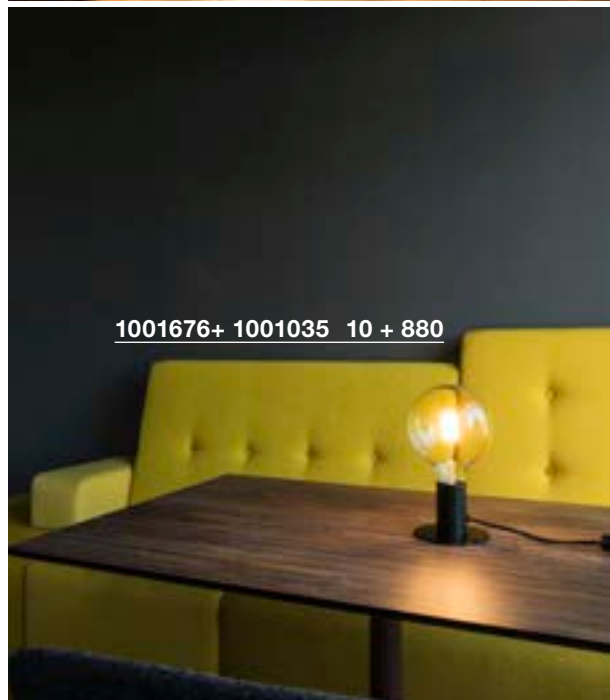

1001676+ 1001035 10 + 880



1002582 11

1002583 11

TONILA
TL

A-A++ Range
A++-E



LED
INSIDE

NEW

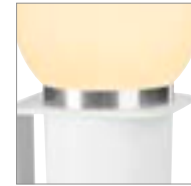

1002583 11

- Mobile, wireless luminaire
- Dimmable in 3 stages using the button
- Convenient charging via USB

Product details

Battery operated
Total consumption: 1.6W
Material: Aluminium / Plastic
Dimmable: Switch



Dimensioned drawing

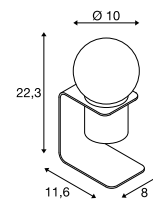

Note

Power supply excl. USB charger 5V DC/1-2A required.



1002583 11

Variant	Item no.
90lm 2700K CRI>80	
white / aluminium	1002582
90lm 2700K CRI>80	
black / brass	1002583

MAGANDA
TL

890

A-A++ Range A++-E



- Illuminated outer edge
- Switch on lamp base
- 3-times optical magnification

Product details

100-240V ~50/60Hz | 12V DC
Total consumption: 4.2W
Material: Steel / Glass

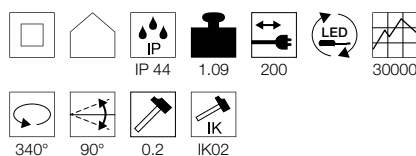

Dimensioned drawing

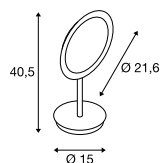

Note

IP 2-pin mains plug

VINCELLI D
TL

898

A-A++ Range A++-E

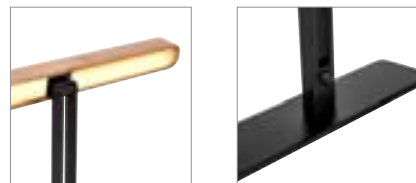

- Slim design
- Lamp unit made from real bamboo

Product details

220-240V ~50Hz | 500mA
Total consumption: 12W
Material: Bamboo / Steel

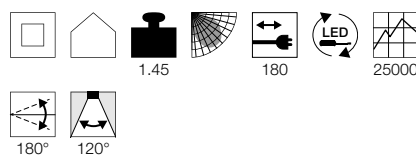

Dimensioned drawing

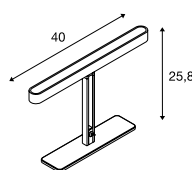

Note

Power supply

1001502 12

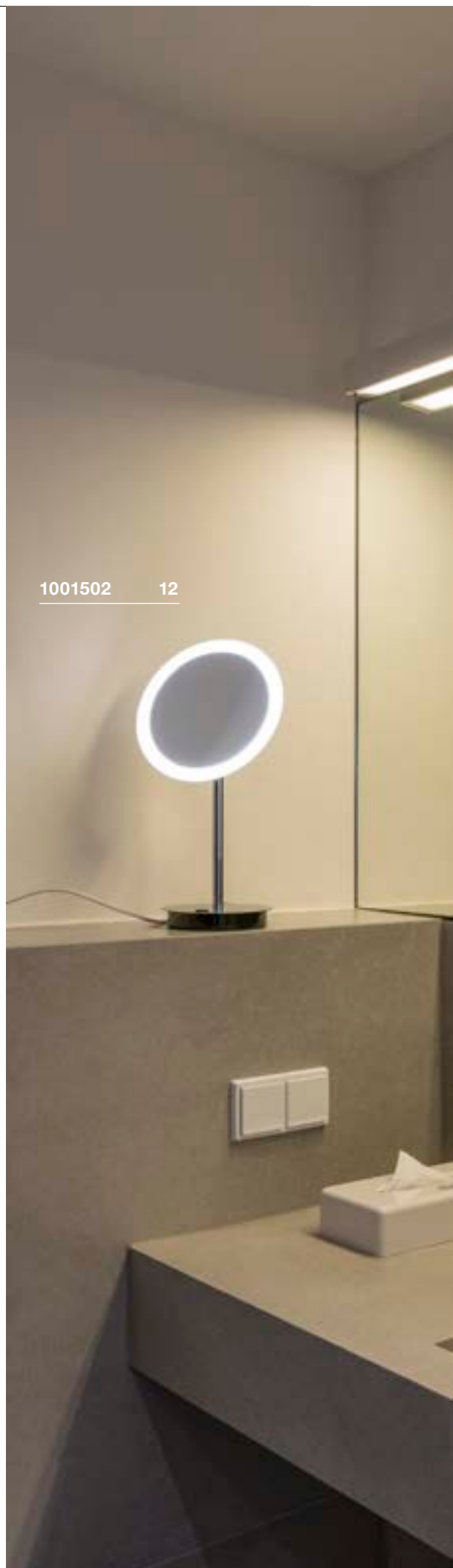

Variant	Item no.
70lm 3000K CRI>80 ■ chrome / white	1001502

Variant	Item no.
500lm 2700K CRI>80 ■ anthracite / brown	1002068

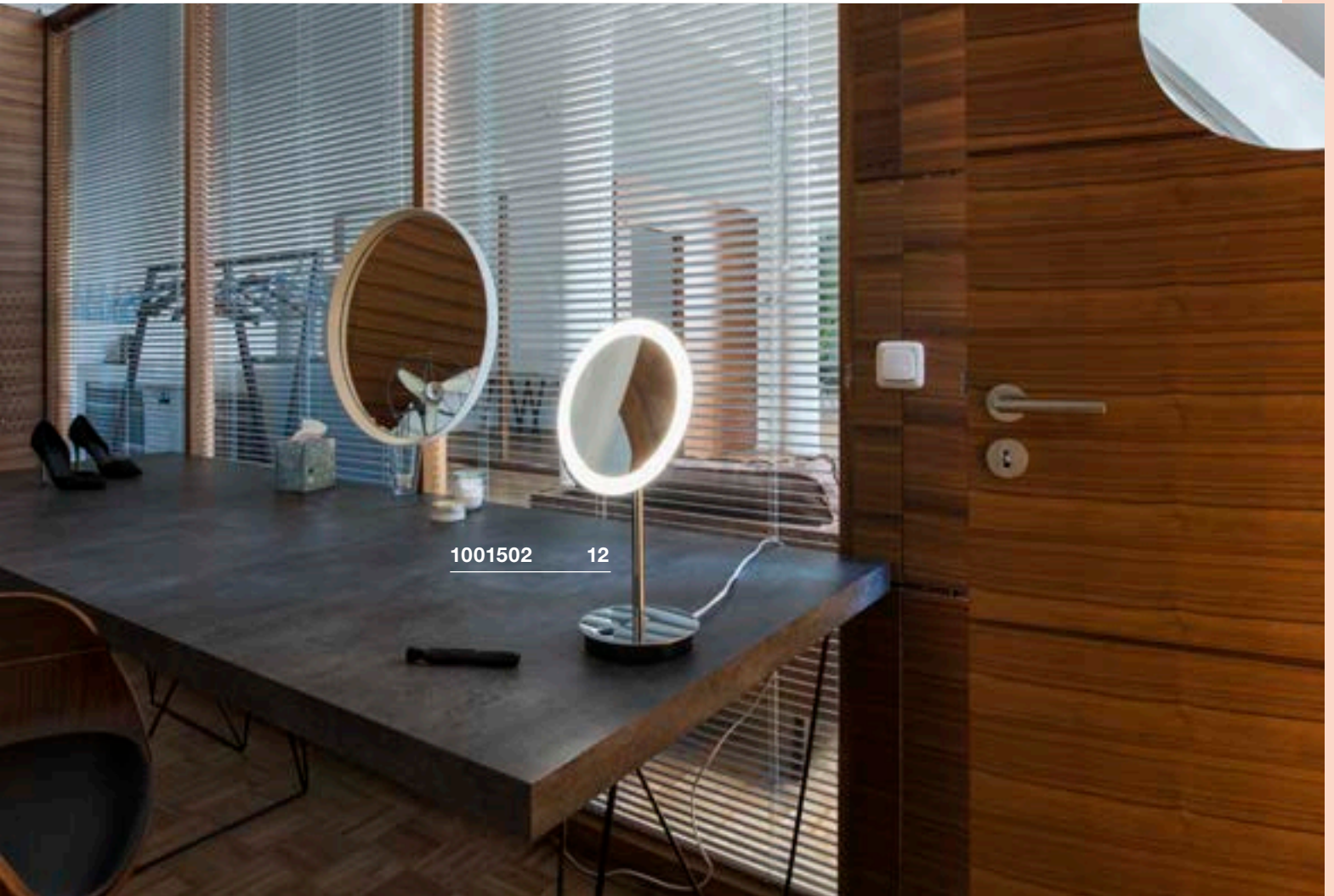

1001502 12



1002068 12



reddot award 2018
winner



DESIGNED BY

Johannes Tomm

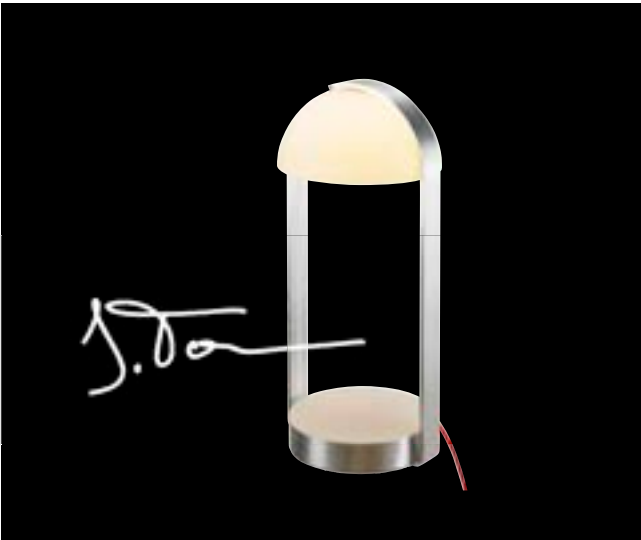



BRENDA
TL, wireless charging



A-A++ Range A++-E

LED
INSIDE



- Dimmable in 3 stages
- Charging surface for wireless Smartphone charging
- Premium LED and USB connection

Product details

220-240V ~50/60Hz | 12V DC
Total consumption: 11W
Material: Aluminium / Glass
Dimmable: Switch

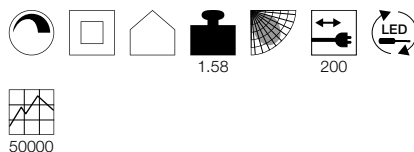

Dimensioned drawing

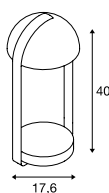

Note

Night light can be switched separately
2-pin plug

Variant	Item no.
Indirect: 460lm 3000K CRI>80 Night light: 50lm 3000K CRI>80 ■ white / matt grey	146111



MODERN TABLE LAMP WITH INDUCTIVE CHARGING FUNCTION

Red Dot Award winner combines modern design and functionality.

Frosted glass and brushed aluminium – combining to create a great aesthetic, complimented by a red power cable.
The BRENDA table lamp can be dimmed to three levels, adapting to the required mood and surroundings by touch. The Brenda does not just impress as a high-quality table lamp; it also provides a night light function (50 lm) and a double Smartphone charging function (inductive charging station and USB connection). Increasing the scope of functionality to a new level, ushering in a new connectivity era (Qi compatible Smartphone required).

The integrated Premium LED module with a service life of 50,000 hours in white, sets new standards with a high degree of economy (EEK A++ at 11 Watts). The Brenda forms part of a product family which was designed by well-known designer Johannes Tomm. Complimentary wall lamps and pendant lamps are also available.

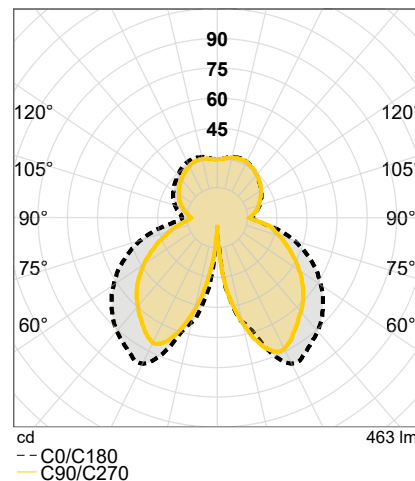

SLV FENDA. MIX & MATCH.

MIX & MATCH

MIX & MATCH Video

bit.ly/slv-mix-match



1003031 + 156111 18 + 19

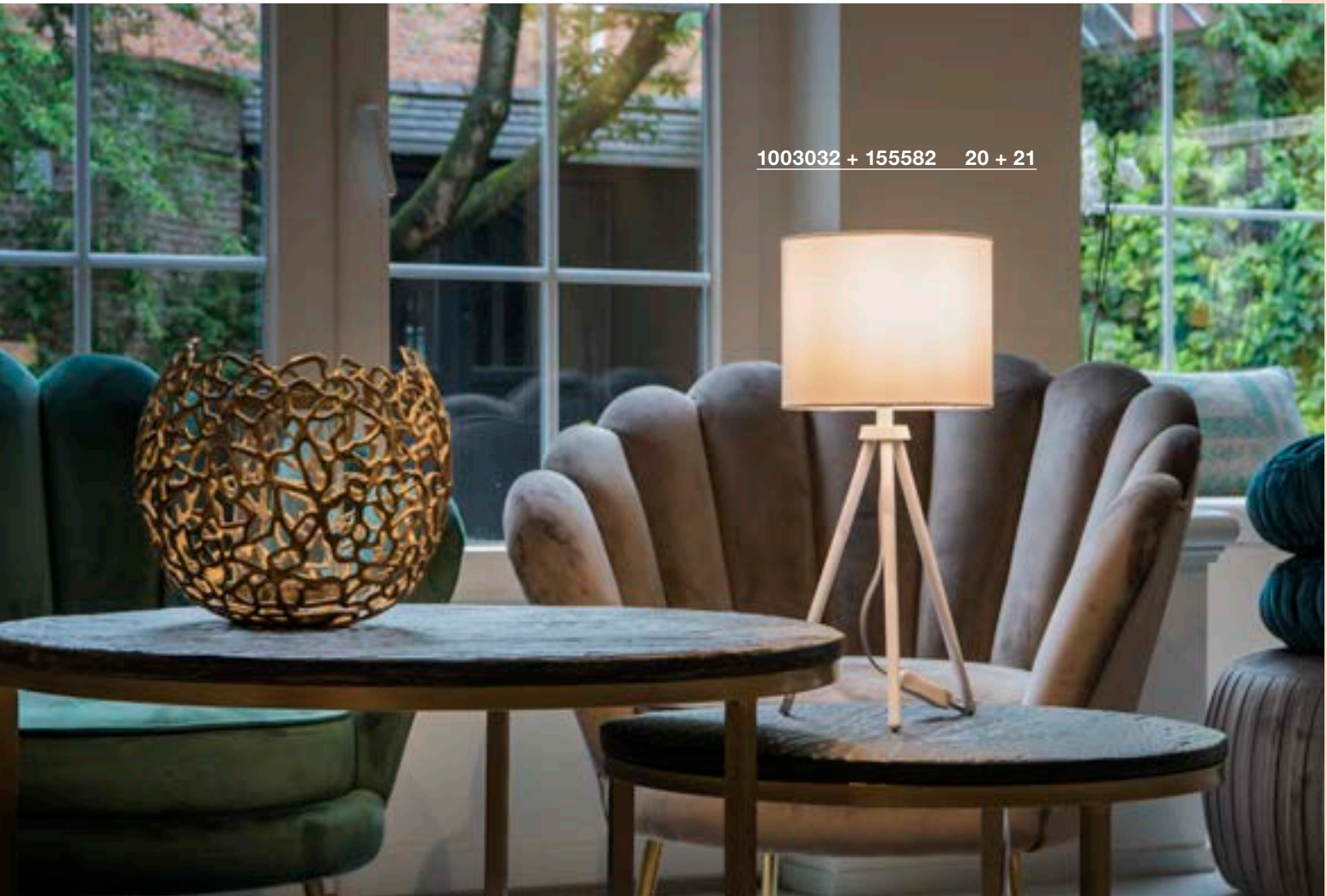

1003032 + 155582 20 + 21



1003029 + 156122 22

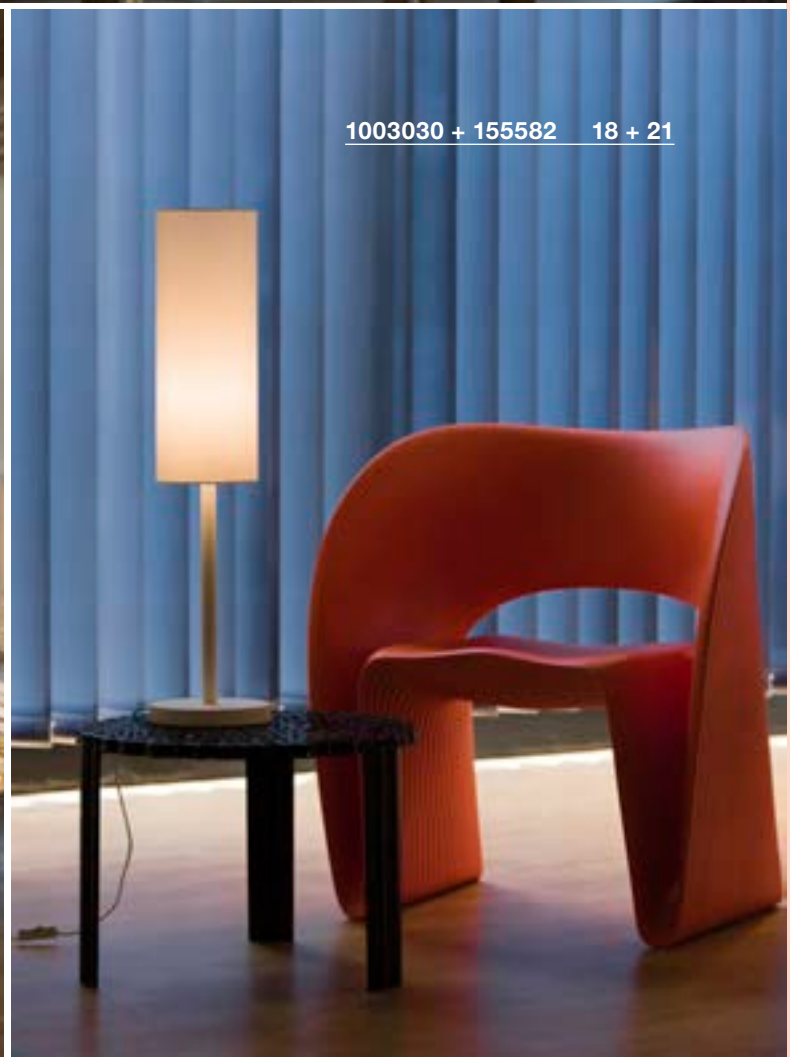

1003030 + 155582 18 + 21

FENDA
TL, E27



E-A++ Range A++-E

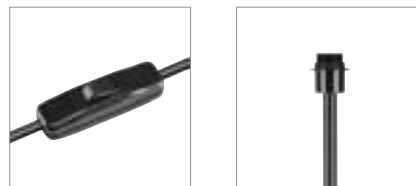

- Individually configurable by selecting the lamp shades
- Switch on connection lead

Product details

220-240V ~50/60Hz
Material: Steel



1.95 200

Dimensioned drawing

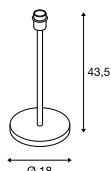

Note

2-pin plug and switch

Recommended lamp

LED E27 14.5W 200°
2700K 1521lm EEL=A+
15kWh/1000h
Item no. 560752



LED E27 7W
2700K 810lm EEL=A+
7kWh/1000h
Item no. 1001038



Lamp details

max. 60W

Variant	Item no.
E27	
□ matt white	1003030
E27	
■ matt black	155780
E27	
■ brushed nickel	155785

FENDA
FL, E27



E-A++ Range A++-E

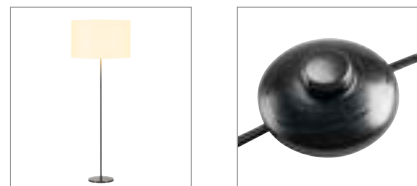

- Individually configurable by selecting the lamp shades
- Foot switch on connection lead

Product details

220-240V ~50/60Hz
Material: Steel



5.1 200

Dimensioned drawing

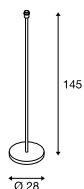

Note

2-pin plug and switch

Recommended lamp

LED E27 11.5W 240°
2700K 1060lm EEL=A+
12kWh/1000h | 3 Step-Dim
Item no. 560432



LED E27 9W 240°
2700-6500K 806lm EEL=A+
9kWh/1000h
Item no. 1001916



Lamp details

max. 60W

Variant	Item no.
E27	
□ matt white	1003031
E27	
■ matt black	155790
E27	
■ brushed nickel	155795

FENDA
Ø 15 cm, round



- Individually configurable by selecting a suitable lamp base

Product details

Material: Textile / Steel



0.22

Dimensioned drawing

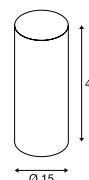

Note

max. 40W

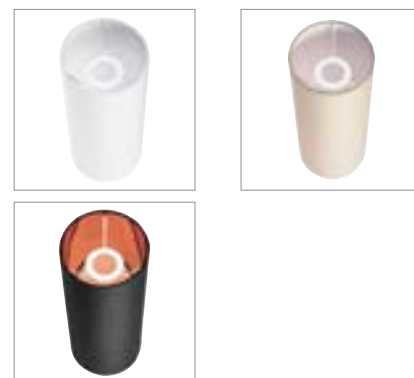

Variant	Item no.
□ white	156141
■ beige	156143
■ black / copper	156152



FENDA
Ø 30 cm, round



- Individually configurable by selecting a suitable lamp base

Product details

Material: Textile / Steel



Dimensioned drawing

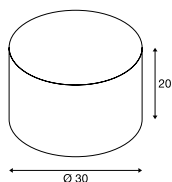

Note

max. 60W



Variant	Item no.
white	155582
beige	155583
black / copper	155592

FENDA
Ø 45 cm, round



- Individually configurable by selecting a suitable lamp base

Product details

Material: Textile / Steel



Dimensioned drawing

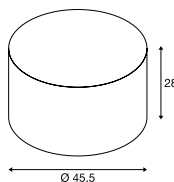

Note

max. 60W



Variant	Item no.
white	156111
beige	156113
black / copper	156122

FENDA
Ø 70 cm, round

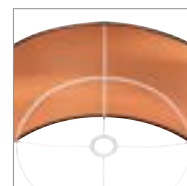

- Individually configurable by selecting a suitable lamp base

Product details

Material: Textile / Steel



Dimensioned drawing

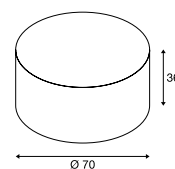

Note

max. 60W



Variant	Item no.
white	1000579
black / copper	1000580

FENDA
TL, E27



E-A++ Range A++-E



- Individually configurable by selecting the lamp shades
- Switch on connection lead

Product details

220-240V ~50/60Hz
Material: Aluminium



Dimensioned drawing

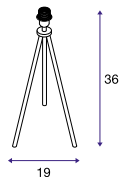

Note

2-pin plug

Recommended lamp

LED E27 9.5W 240°
2200-6700K 806lm EEL=A+
10kWh/1000h
Item no. 560161



Lamp details

max. 40W

Variant	Item no.
E27	
□ matt white	1003032
E27	
■ matt black	155540

FENDA
FL, E27



E-A++ Range A++-E

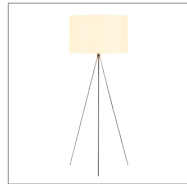

- Individually configurable by selecting the lamp shades
- Switch on the lamp head

Product details

220-240V ~50/60Hz
Material: Aluminium



Dimensioned drawing

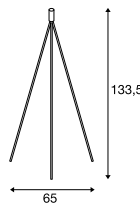

Note

2-pin plug

Recommended lamp

LED E27 8.5W
2700K 806lm EEL=A+
10kWh/1000h
Item no. 560161



Lamp details

max. 40W

Variant	Item no.
E27	
□ matt white / shiny black	1003033
E27	
■ matt black	155490
E27	
■ chrome	155492

FENDA
Ø 15 cm, round



- Individually configurable by selecting a suitable lamp base

Product details

Material: Textile / Steel



Dimensioned drawing

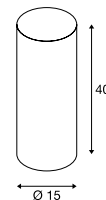

Note

max. 40W



Variant	Item no.
□ white	156141
■ beige	156143
■ black / copper	156152



FENDA
Ø 30 cm, round



- Individually configurable by selecting a suitable lamp base

Product details

Material: Textile / Steel



Dimensioned drawing

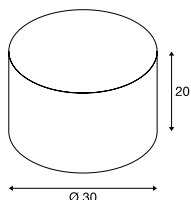

Note

max. 60W



Variant	Item no.
white	155582
beige	155583
black / copper	155592

FENDA
Ø 45 cm, round



- Individually configurable by selecting a suitable lamp base

Product details

Material: Textile / Steel



Dimensioned drawing

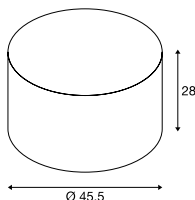

Note

max. 60W



Variant	Item no.
white	156111
beige	156113
black / copper	156122

FENDA
Ø 70 cm, round

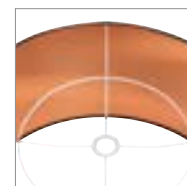

- Individually configurable by selecting a suitable lamp base

Product details

Material: Textile / Steel



Dimensioned drawing

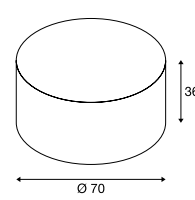

Note

max. 60W

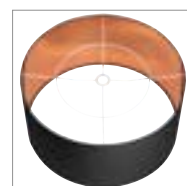
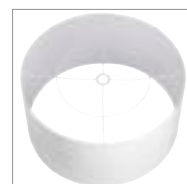

Variant	Item no.
white	1000579
black / copper	1000580

FENDA BOW BASIC
FL, E27



- Individually configurable by selecting the lamp shades
- Foot switch on connection lead

Product details

220-240V ~50/60Hz
Material: Steel



Dimensioned drawing

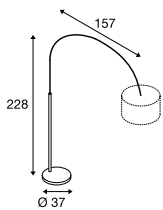

Note

Max. permitted shade weight 900 g
2-pin plug and switch

Recommended lamp

LED E27 9W 240°
2700-6500K 806lm EEL=A+
9kWh/1000h
Item no. 1002127



LED E27 7W
2700K 810lm EEL=A++
7kWh/1000h
Item no. 1001038



Lamp details

max. 25W
L: 17.5 cm max.

Variant	Item no.
E27	
□ matt white	1003028
■ matt black	1003029
E27	
■ chrome	1000763

FENDA
Ø 40 cm, round



- Individually configurable by selecting a suitable lamp base

Product details

Material: Polymethylacrylate (PMMA)



Dimensioned drawing

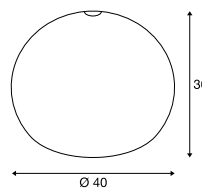

Note

max. 60W

Variant	Item no.
□ white	1000764

FENDA
Ø 45 cm, round



- Individually configurable by selecting a suitable lamp base

Product details

Material: Textile / Steel



Dimensioned drawing

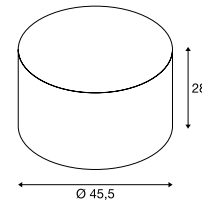

Note

max. 60W

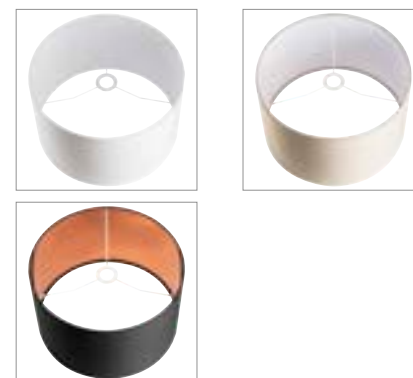

Recommended accessories

Acrylic glass cover
Item no. 156100

Variant	Item no.
□ white	156111
■ beige	156113
■ black / copper	156122



1003029 + 156122

22



1000763 + 1000764

22

BISHADE
TL, E27



885

E-A++ Range A++-E

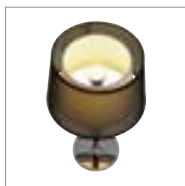

- Double conical lamp shade
- Switch on connection lead

Product details

230V ~50Hz

Material: Artificial leather / extile



2.5

200

Dimensioned drawing

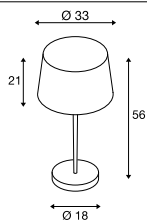

Note

2-pin plug and switch

Recommended lamp

LED E27 9.1W 240°
2700K 760lm EEL=A+
10kWh/1000h

Item no. 560402



LED E27 11.5W 240°
2700K 1060lm EEL=A+
12kWh/1000h | 3 Step-Dim

Item no. 560432



Lamp details

max. 25W

L: 15 cm max.

Variant	Item no.
E27	
<input type="checkbox"/> transparent / white	155651

BISHADE
FL, E27



885

E-A++ Range A++-E



- Double conical lamp shade
- Foot switch on connection lead

Product details

230V ~50Hz

Material: Artificial leather / extile



6.9

200

Dimensioned drawing

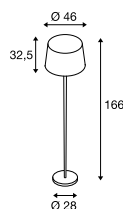

Note

2-pin plug and switch

Recommended lamp

LED E27 14.5W 200°
2700K 1521lm EEL=A+
15kWh/1000h

Item no. 560422



LED E27 9W 240°
2700-6500K 806lm EEL=A+
9kWh/1000h

Item no. 1001916



Lamp details

max. 40W

L: 22 cm max.

Variant	Item no.
E27	
<input type="checkbox"/> transparent / white	155652

155651

24



155652

24



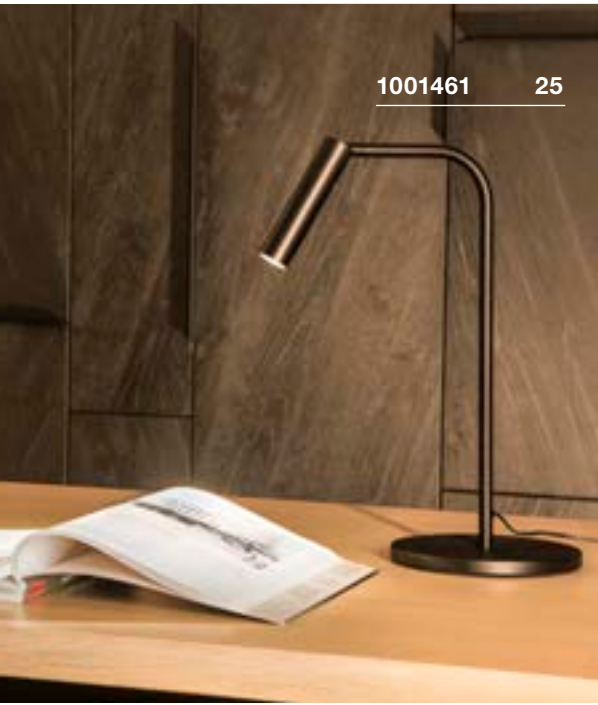

1001461 25

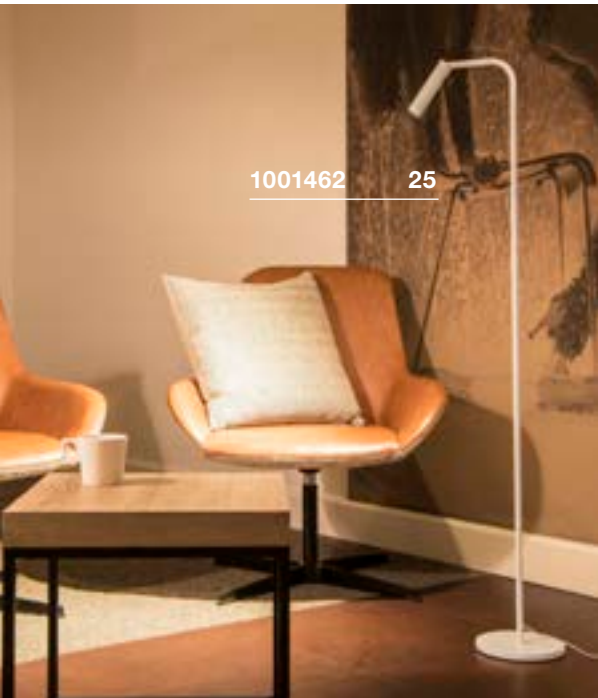

1001462 25



1001463 25

KARPO TL



A-A++ Range A++-E



- Premium LED with CRI>90
- Switch on lamp head
- Dimmable in 3 stages using the button

Product details

100-240V ~50/60Hz | 500mA
 Total consumption: 6.5W
 Material: Aluminium
 Dimmable: Switch

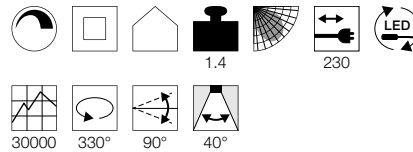

Dimensioned drawing

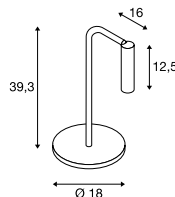

KARPO FL



A-A++ Range A++-E



- Premium LED with CRI>90
- Switch on lamp head
- Dimmable in 3 stages using the button

Product details

100-240V ~50/60Hz | 500mA
 Total consumption: 6.5W
 Material: Aluminium
 Dimmable: Switch

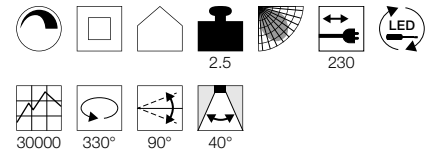

Dimensioned drawing

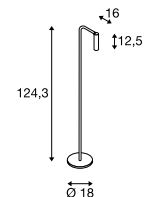

Variant	Item no.
400lm 3000K CRI>90 □ white	1001460
330lm 3000K CRI>90 ■ black	1001461

Variant	Item no.
400lm 3000K CRI>90 □ white	1001462
330lm 3000K CRI>90 ■ black	1001463

PHELIA
TL, QPAR51



E-A++ Range A++-E



- Switch on the lamp head
- Head can be tilted 90°
- Lamp shade lacquered in white on the inside

Product details

230V ~50/60Hz
Material: Aluminium / Steel

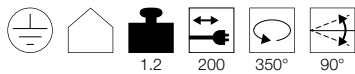

1.2 200 350° 90°

Dimensioned drawing

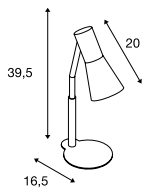

Note

Shock-proof 2-pin plug and switch

Recommended lamp

LED GU10 5.5W 38°
2700K 400lm EEL=A+
6kWh/1000h
Item no. 1001030



LED GU10 5.5W 36°
2800K 420lm EEL=A+
6kWh/1000h
Item no. 1001217



Lamp details

max. 35W QPAR51
Ø: 5 cm max. L: 10.5 cm max.

Variant	Item no.
GU10 QPAR51	
■ black	146000
GU10 QPAR51	
□ white	146001

PHELIA
FL, E27



E-A++ Range A++-E



- Switch on the lamp head
- Head can be tilted 90°
- Lamp shade lacquered in white on the inside

Product details

230V ~50/60Hz
Material: Aluminium / Steel



6.3 200 350° 90°

Dimensioned drawing

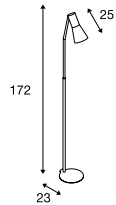

Note

Shock-proof 2-pin plug and switch

Recommended lamp

LED E27 14.5W 200°
2700K 1521lm EEL=A+
15kWh/1000h
Item no. 560422



LED E27 11.5W 240°
2700K 1060lm EEL=A+
12kWh/1000h | **3 Step-Dim**
Item no. 560432



Lamp details

max. 23W
Ø: 5.3 cm max. L: 18 cm max.

Variant	Item no.
E27	
■ black	146010
E27	
□ white	146011



146000

26

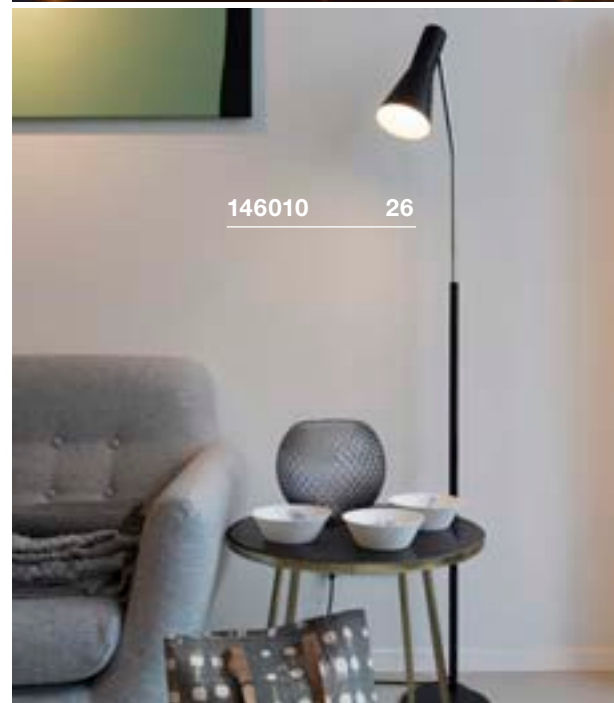

146010

26



146010

26

146000

26

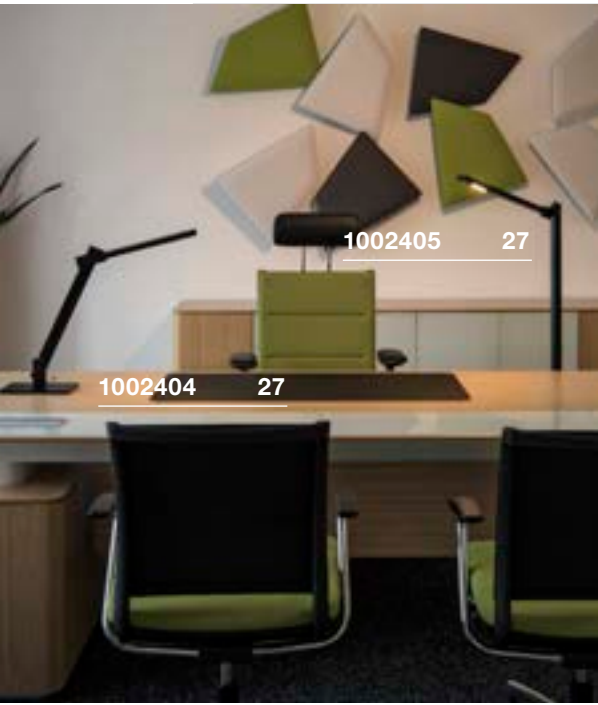

MECANICA PLUS
TL

A-A++ Range A++-E

LED INSIDE

NEW VARIANT



- Dimming function and colour tuning

Product details

100-240V ~50/60Hz | 12V DC
 Total consumption: 7W
 Material: Aluminium
 Dimmable: Switch

3.2 200

30000 329° 306° 100°

Dimensioned drawing

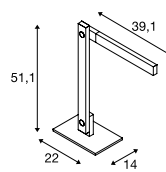

Note

Power supply

Variant	Item no.
450lm 2700-6500K CRI>80 ■ black	1002404

MECANICA PLUS
FL

A-A++ Range A++-E

LED INSIDE

NEW VARIANT



- Dimming function and colour tuning

Product details

100-240V ~50/60Hz | 12V DC
 Total consumption: 7W
 Material: Aluminium
 Dimmable: Switch

5.76 200

30000 329° 306° 100°

Dimensioned drawing

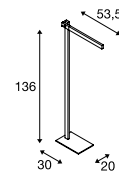

Note

Power supply

Variant	Item no.
450lm 2700-6500K CRI>80 ■ black	1002405

LIGHT PIPE 60/90/140 Pole, TRIAC



A-A++ Range A++-E

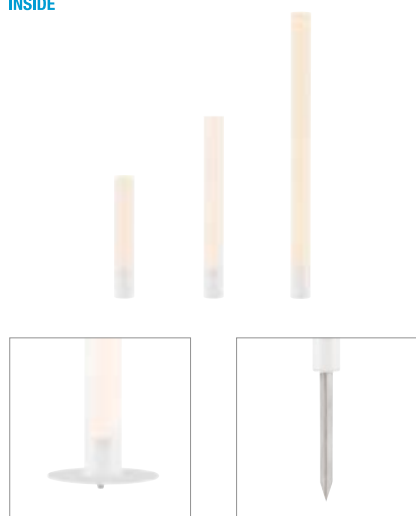

• Suitable for indoor and outdoor use

Product details

220-240V ~50/60Hz
 Total consumption: 11W
 Material: Aluminium / Polymethylacrylate (PMMA)
 Dimmable: Triac C, Triac L

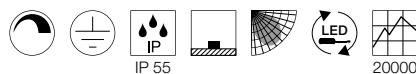

Dimensioned drawing

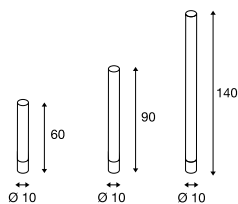

Note

Luminaire supplied without a mounting plate.
 Indoor installation plate with foot switch on the connection lead.
 Outdoor installation plate without foot switch, with IP44 shock-proof mains plug.

Recommended accessories

Earth spike

Item no. 234430

Outdoor installation plate

Item no. 234431

Indoor installation plate

Item no. 234441



Variant	Item no.
630lm 2700K CRI>80 H: 60 cm 1.5 kg □ white	234401
630lm 2700K CRI>80 H: 90 cm 1.71 kg □ white	234411
630lm 2700K CRI>80 H: 140 cm 2.06 kg □ white	234421



234421 28

234411 28



234411 28

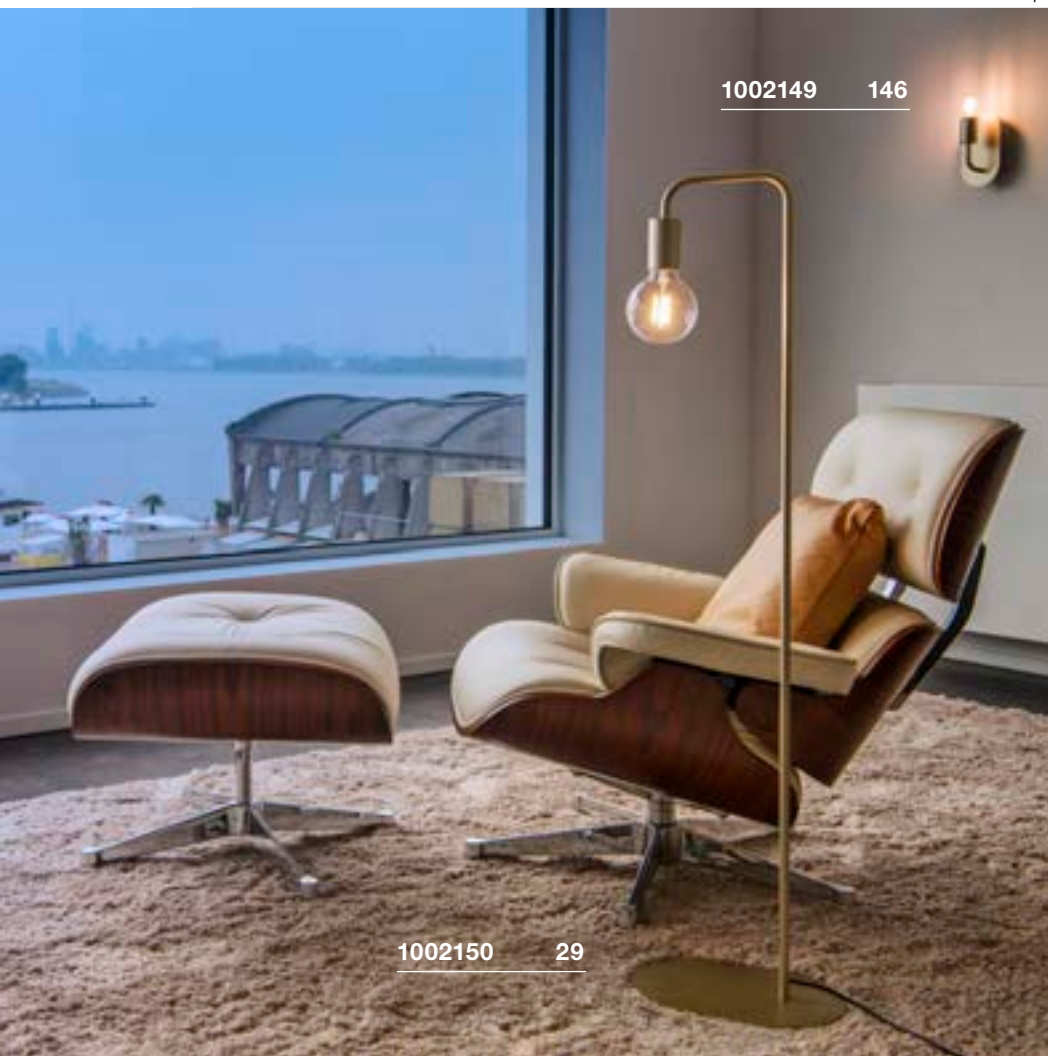

1002149 146

1002150 29



1002146 29

FITU
FL, E27

887

E-A++ Range A++-E

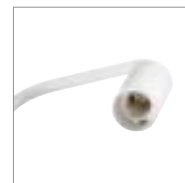
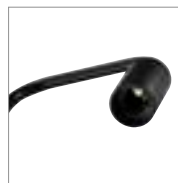

- Foot switch on connection lead

Product details

220-240V ~50/60Hz
Material: Aluminium / Steel

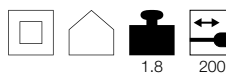

Dimensioned drawing

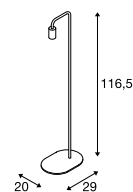

Note

2-pin plug and switch

Recommended lamp

E27 5W 330°
2000K 500lm EEL=A+
5kWh/1000h
Item no. 560741

LED E27 7W 330°
2700K 806lm EEL=A+
8kWh/1000h
Item no. 1001038



Lamp details

max. 24W

Variant	Item no.
E27 □ white	1002145
E27 ■ black	1002146
E27 ■ gold	1002150

WORKLIGHT
FL



A-A++ Range
A++-E



- Switch on the lamp body
- Direct and indirect light

Product details

220-240V ~50/60Hz | 226mA
Total consumption: 35W
Material: Aluminium / Acrylic

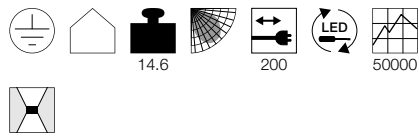

14.6

200

50000

Dimensioned drawing

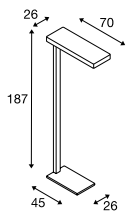

Note

Shock-proof 2-pin plug

Variant	Item no.
Direct: 1850lm 3000K CRI>80 Indirect: 1850lm 3000K CRI>80	157901
white	
Direct: 1850lm 3000K CRI>80 Indirect: 1850lm 3000K CRI>80	157905
anthracite	





WORKLIGHT PLUS FL, DALI



A-A++ Range A++-E



- Intelligent presence control and brightness sensor
- Suitable for screen workplaces in accordance with EN 12464-1
- Direct and indirect light

Product details

220-240V ~50/60Hz | 226mA
 Total consumption: 48W
 Material: Aluminium / Acrylic
 Dimmable: Dali

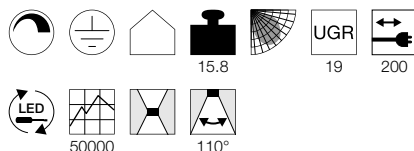

Dimensioned drawing

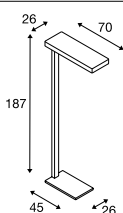

Note

Switch on the luminaire shaft
 Shock-proof 2-pin plug

Variant	Item no.
Direct: 3600lm 3000K CRI>80 Indirect: 1800lm 3000K CRI>80	
white	1002847
Direct: 3600lm 3000K CRI>80 Indirect: 1800lm 3000K CRI>80	
anthracite	1002848

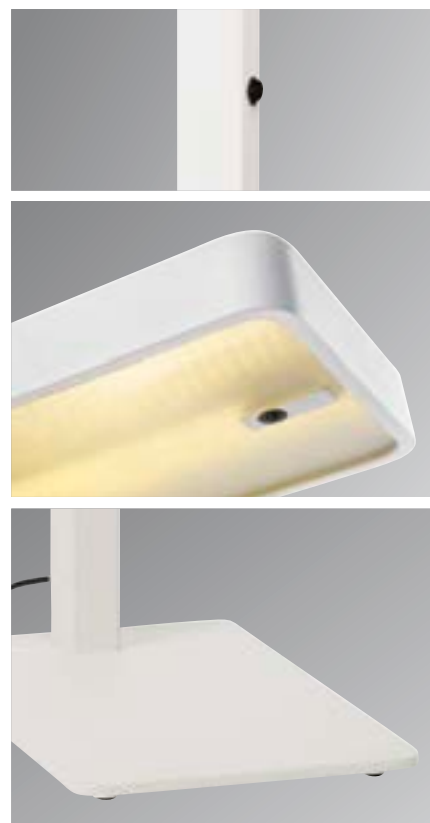
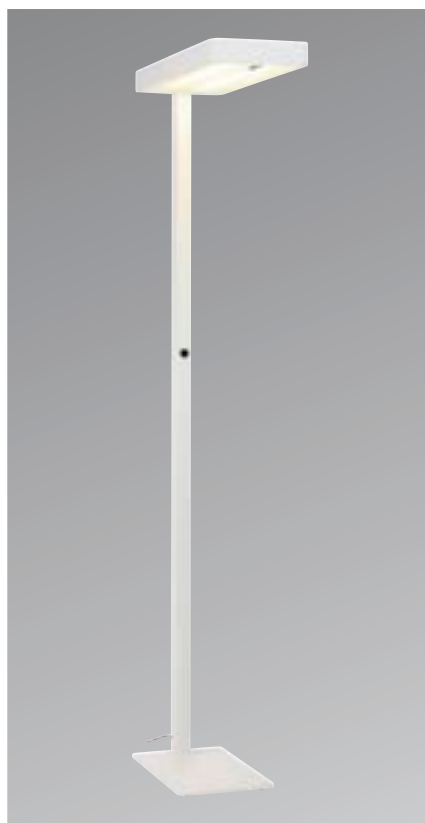

MOBILE AND INTELLIGENT WORKPLACE LIGHT FOR THE MODERN OFFICE

Energy efficient and long-lasti

As a consistent further development of our WORKLIGHT series, we introduce a mobile workplace light for **workstations (UGR ≤19)** with the DALI SENSOR version, equipped with state-of-the-art technology and **powerful LEDs with a service life of 50,000 hours** from Philips. The energy saving potential is optimized due to being equipped with intelligent light control. **Thanks to the integrated presence control, the light switches on and off automatically depending on movement**, and the lumen output is controlled by the daylight sensor. This ensures that there is a consistent light level at the workplace.

The combination of **direct and indirect light output** provides widespread illumination. The WORKLIGHT is also available as a pendant.

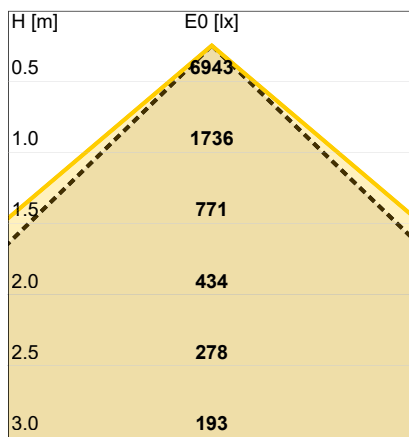

-- C0/C180 (half-peak divergence: 82.4°)
 — C90/C270 (half-peak divergence: 88.4°)

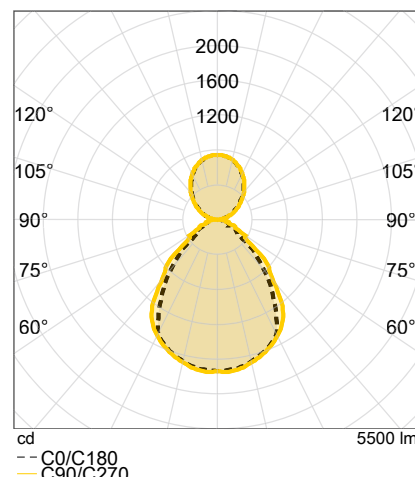

HANGING AROUND.

PENDANTS CREATE EMPHASIS.

Give each room an individual feel: with pendants you immerse selected areas in atmospheric light and set visual highlights thanks to a wide range of style directions. Perfect for rest in restaurants, cafés, bars or at home – the luminaires create cosy locations and make a tasteful statement.





143430

57

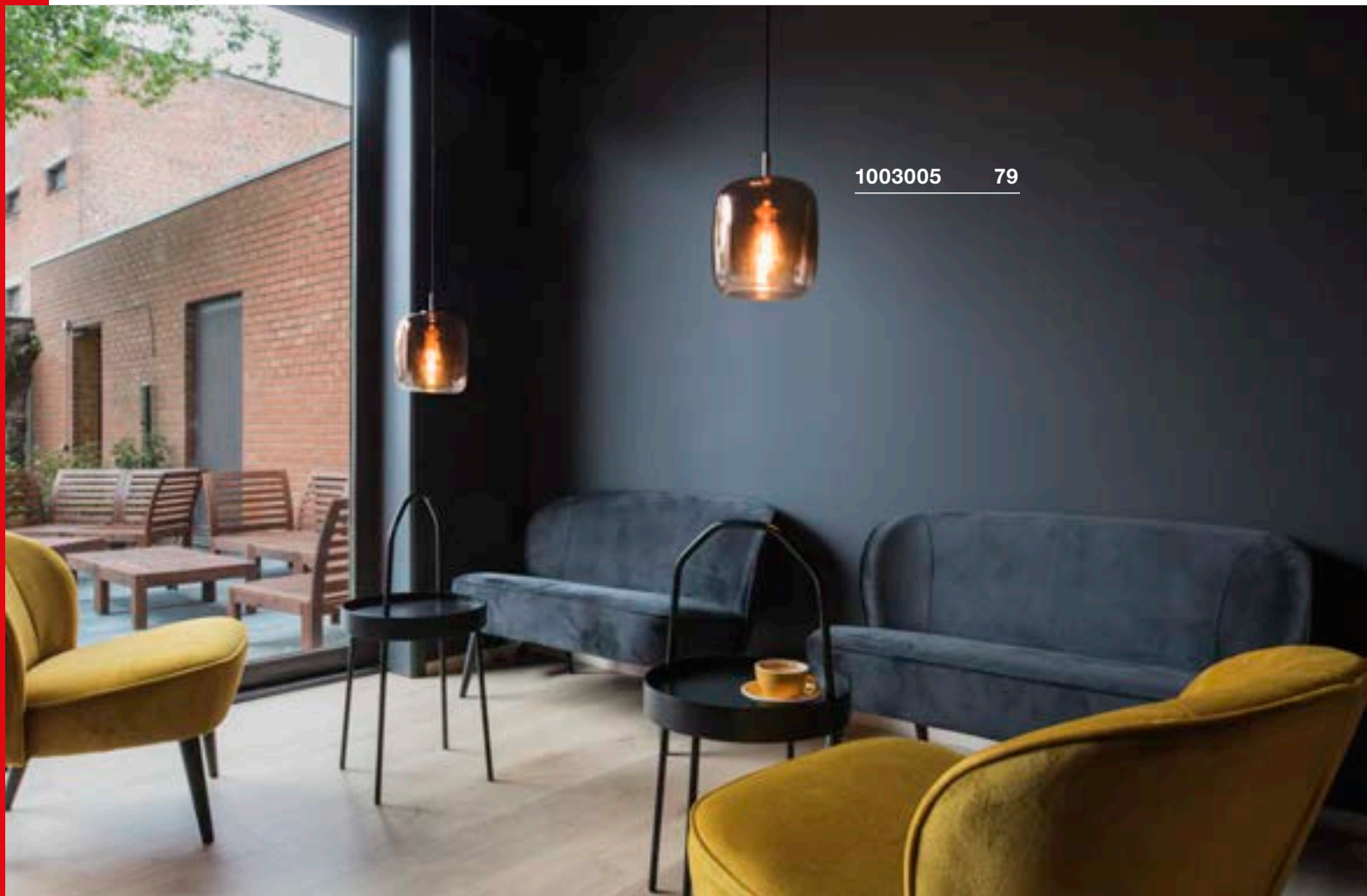

1003005 79

PENDANTS

							
036	036	037	038	039	044	044	044
							
046	047	047	047	048	049	049	050
							
050	053	053	053	055	055	056	057
							
057	057	058	058	058	059	061	061
							
062	062	062	065	065	066	066	066



 Other luminaires and variants can be found online at www.slv.com

FITU
PD, E27



E-A++ Range A++-E

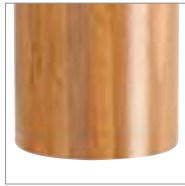

- Lamp unit made from real bamboo
- Can be combined with Fitu ceiling plates and accessories

Product details

220-240V ~50/60Hz
Material: Bamboo / Steel



Dimensioned drawing

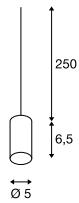

Note

Textile cable
Open cable end

Recommended lamp

LED E27 7W 280°
2200-2700K 830lm EEL=A++
7kWh/1000h



Item no. 1002126

LED E27 7W 180°
2700K 630lm EEL=A+
8kWh/1000h



Item no. 1001357

Lamp details

max. 60W

Variant	Item no.
E27 ■ anthracite / brown	1000581

FITU
PD, E27



E-A++ Range A++-E



- 2.5 m long cable
- Can be combined with Fitu ceiling plates and accessories

Product details

220-240V ~50/60Hz
Material: Aluminium



Dimensioned drawing

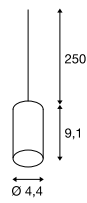

Note

Textile cable
Open cable end

Recommended lamp

E27 5W 330°
2000K 500lm EEL=A+
5kWh/1000h



Item no. 560741

Lamp details

max. 60W

Variant	Item no.
E27 ■ black	132650
E27 □ white	132651
E27 ■ gold	1002167

1000581 36



132600 + 132650 40 + 36





132600 + 132650 40 + 36

FITU
PD, E27E-A++ Range
A++-E

- 5 m long cable
- Can be combined with Fitu ceiling plates and accessories

Product details

220-240V ~50/60Hz
Material: Aluminium

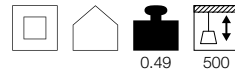
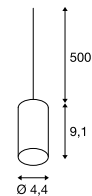
**Dimensioned drawing****Note**

Textile cable
Open cable end

Recommended lamp

LED E27 7W 330°
2700K 806lm EEL=A+
8kWh/1000h

Item no. 1001035



LED E27 7W 280°
2200-2700K 830lm EEL=A++
7kWh/1000h

Item no. 1002126

**Lamp details**

max. 60W

Variant	Item no.
E27	
■ black	132690
E27	
□ white	132691
E27	
■ gold	1002168

FITU
PD, E27



E-A++ Range
A++-E



- 2.5 m long cable
- Can be combined with Fitu ceiling plates and accessories
- Extra-long lamp body

Product details

220-240V ~50/60Hz
Material: Aluminium



Dimensioned drawing

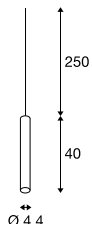

Note

Textile cable
Open cable end

Recommended lamp

LED E27 7W 280°
2700K 790lm EEL=A++
7kWh/1000h



Item no. 1002124

LED E27 7W 180°
2700K 630lm EEL=A+
8kWh/1000h



Item no. 1001357

Lamp details

max. 60W

Variant	Item no.
E27	
■ black	1002159
E27	
□ white	1002160
E27	
■ brushed aluminium	1002161
E27	
■ gold	1002162



1002162 38

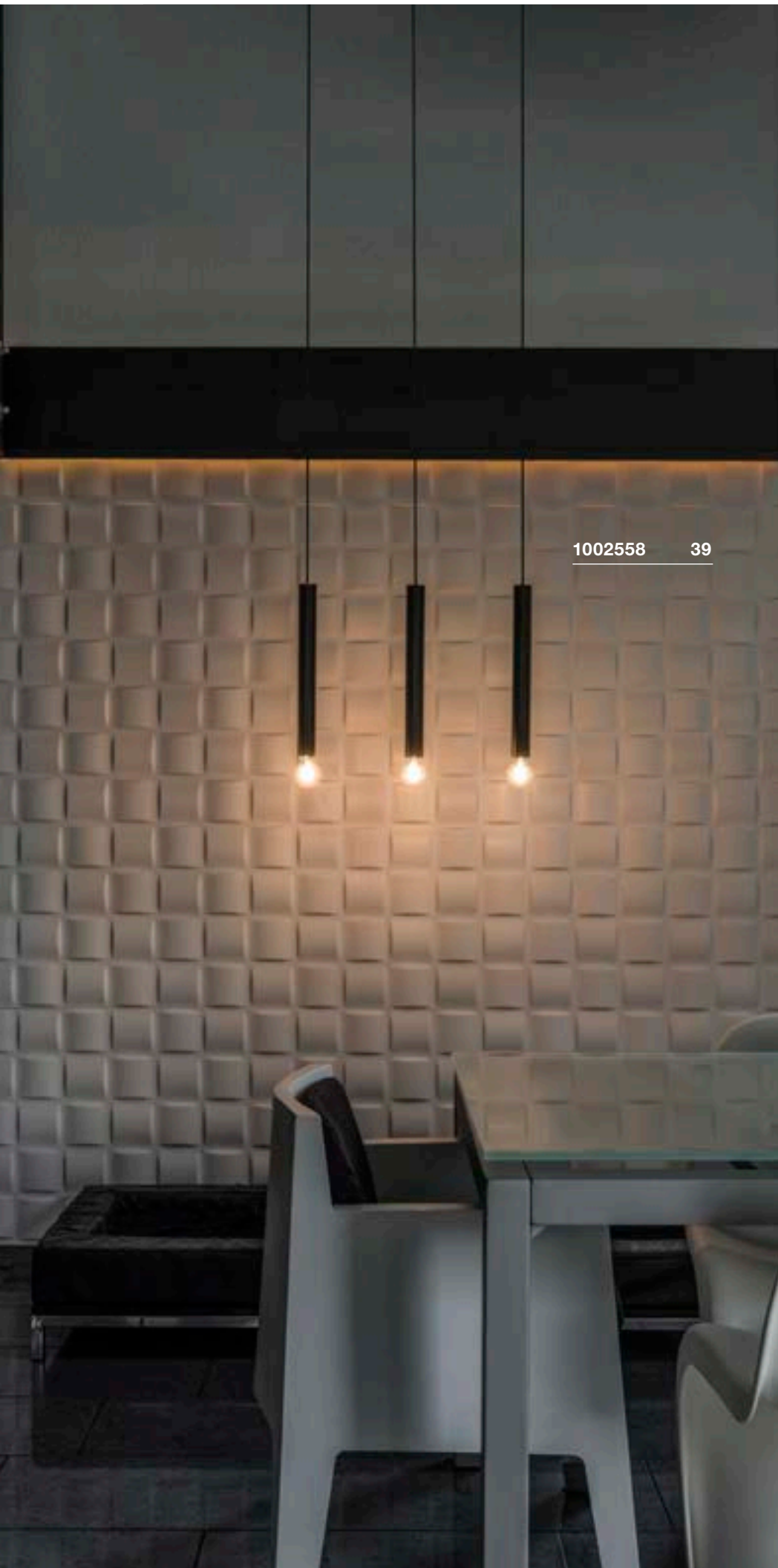

1002558 39

FITU
PD, E27 887E-A++ Range
A++-ENEW
VARIANT

- 5 m long cable
- Can be combined with Fitu ceiling plates and accessories

Product details

220-240V ~50/60Hz
Material: Aluminium

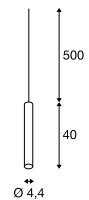
**Dimensioned drawing****Note**

Textile cable
Open cable end

Recommended lamp





LED E27 8W
2000-2900K 500lm EEL=A
8kWh/1000h
Item no. 1002124



LED E27 8W 350°
2200K 250lm EEL=B
8kWh/1000h
Item no. 1001357

**Lamp details**

max. 60W

Variant	Item no.
E27	
■ black	1002558 
E27	
□ white	1002562 
E27	
■ brushed aluminium	1002563 
E27	
■ gold	1002564 

FITU MIX&MATCH ACCESSORIES

Fitu single ceiling plate

16A max.
Steel
Ø: 8.5 cm H: 3.9 cm
0.14 kg
1 pc.



Variant	Item no.
■ black	132600
□ white	132601
■ chrome	132605
■ gold	1002163

Fitu triple ceiling plate

Steel
1.08 kg
L: 60 cm W: 8.5 cm H: 5 cm
Fastening materials, incl.



Variant	Item no.
■ black	1001818
□ white	1001819
■ gold	1002264

1-phase lamp adapter

230V ~50Hz, 6A max.
Plastic PC
L: 8.2 cm W: 3.5 cm H: 4.2 cm
0.04 kg
Maximum mechanical load: 3kg
1 pc.



Variant	Item no.
■ black	143120
□ white	143121
■ silver-grey	143124

Fitu triple ceiling plate

16A max.
Steel
Ø: 22 cm H: 5.4 cm
0.5 kg
1 pc.



Variant	Item no.
■ black	132610
□ white	132611
■ chrome	132615
■ gold	1002164

Fitu quintuple ceiling plate

Steel
2.06 kg
L: 120 cm W: 8.5 cm H: 5 cm
Fastening materials, incl.



Variant	Item no.
■ black	1001820
□ white	1001821
■ gold	1002265

3-phase lamp adapter

230V ~50Hz, 10A max.
Plastic
0.07 kg
Maximum mechanical load: 5kg
1 pc.



Variant	Item no.
■ black	145990
□ white	1001542
■ silver-grey	145994

Fitu quintuple ceiling plate

16A max.
Steel
Ø: 33 cm H: 6 cm
1.25 kg
1 pc.



Variant	Item no.
■ black	132620
□ white	132621
■ chrome	132625
■ gold	1002165

Ceiling hook

16A max.
Steel
L: 60 cm W: 8.5 cm H: 5 cm
Weight: 1.08 kg
1 pc.



Variant	Item no.
■ black	132670
□ white	132671

Cable clamp

16A max.
Steel
L: 60 cm W: 8.5 cm H: 5 cm
Weight: 1.08 kg
1 pc.



Variant	Item no.
■ black	132680
□ white	132681



132690 37

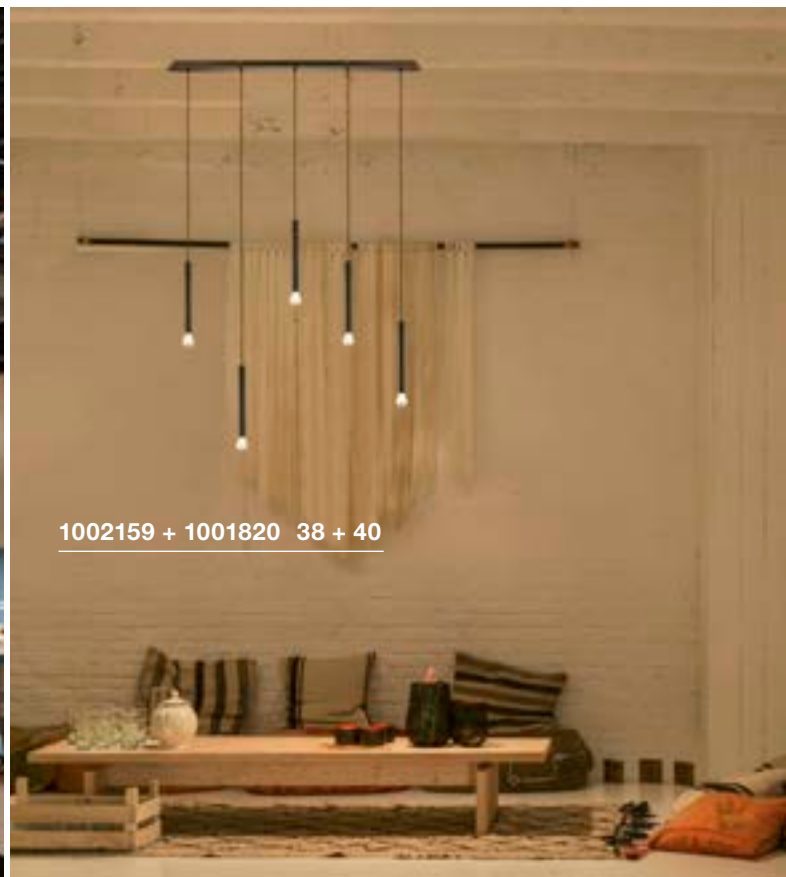

1002159 + 1001820 38 + 40



1002162 + 1002165 38 + 40



SLV FENDA. MIX & MATCH.

MIX & match

MIX & MATCH Video

bit.ly/slv-mix-match



132662 + 156122 44 + 47



132660 + 1000580 44 + 46



1000773 + 132661 44

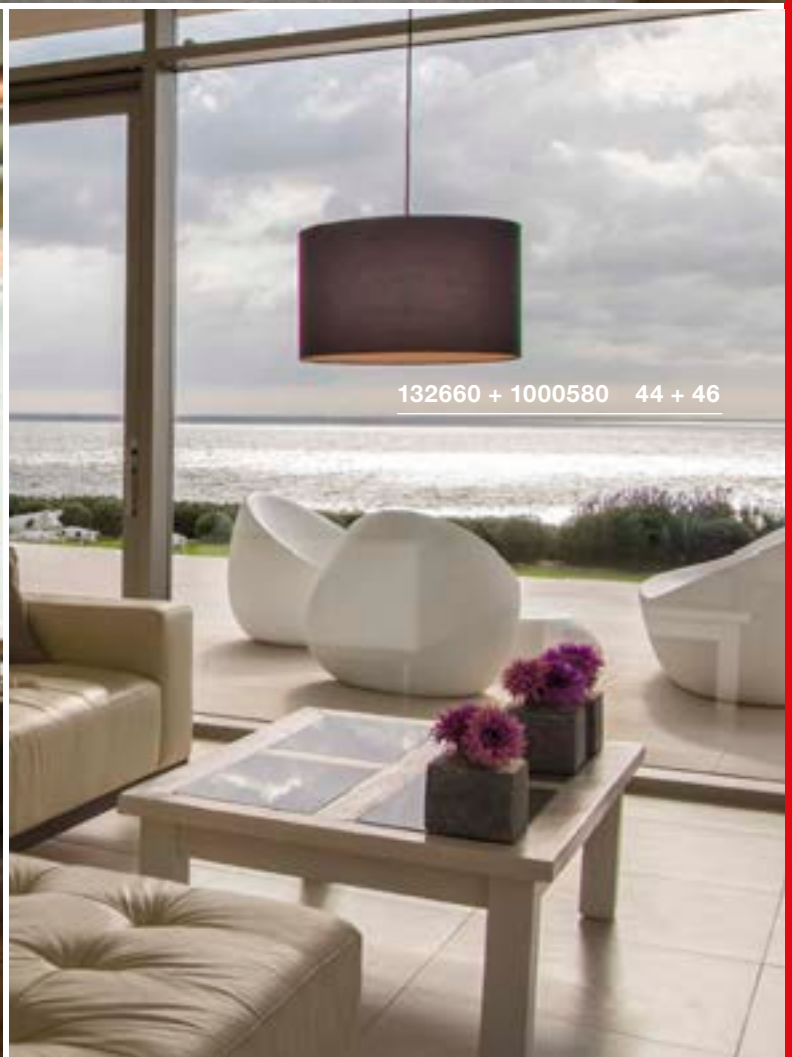

132660 + 1000580 44 + 46

FENDA
PD, E27



E-A++ Range A++-E



- Individually configurable by selecting the lamp shade

Product details

230V ~50Hz
Material: Steel / Plastic



Dimensioned drawing

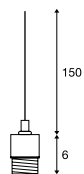

Note

Open cable end

Recommended accessories

■ 1-circuit lamp adapter
Item no. 143120



■ 3-circuit lamp adapter
Item no. 145990



Recommended lamp

LED E27 7W 280°
2700K 790lm EEL=A++
7kWh/1000h
Item no. 1002124



LED E27 7W 280°
2200-2700K 830lm EEL=A++
7kWh/1000h
Item no. 1002126



Lamp details

max. 60W

Variant	Item no.
E27	
■ black	132660
E27	
□ white	132661
E27	
■ chrome	132662

FENDA
Glass shade



- Individually configurable by selecting a suitable lamp base

Product details

Material: Glass



Dimensioned drawing

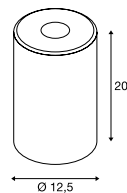

Note

max. 40W
Can be combined with the Fitu Mix & Match accessory on page 40

Variant	Item no.
■ transparent brown	1000773
□ white	1002217

FENDA
Ø 40 cm, round



- Individually configurable by selecting a suitable lamp base

Product details

Material: Polymethylacrylate (PMMA)



Dimensioned drawing

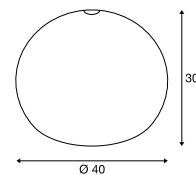

Note

max. 60W

Variant	Item no.
□ white	1000764

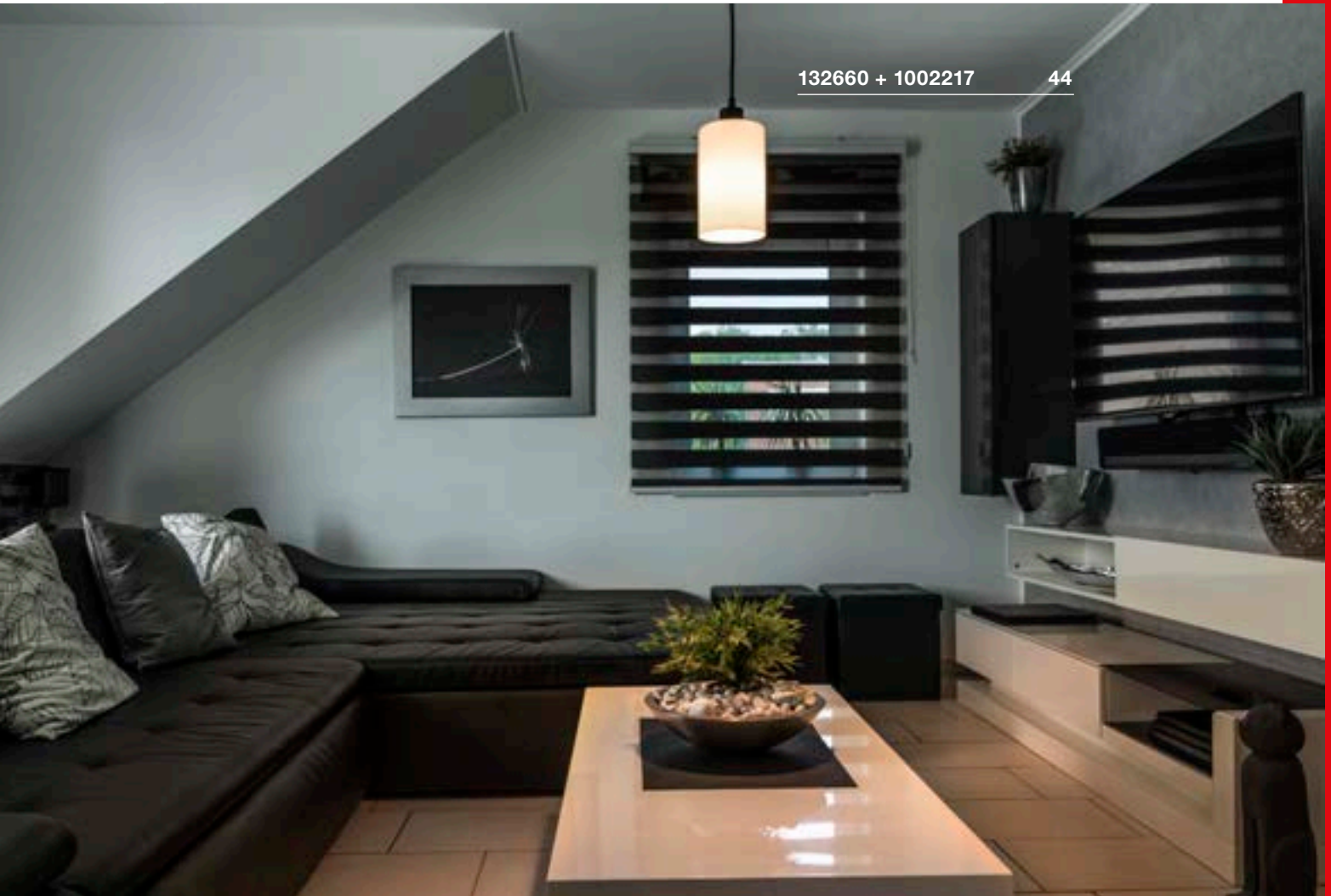

132660 + 1002217

44

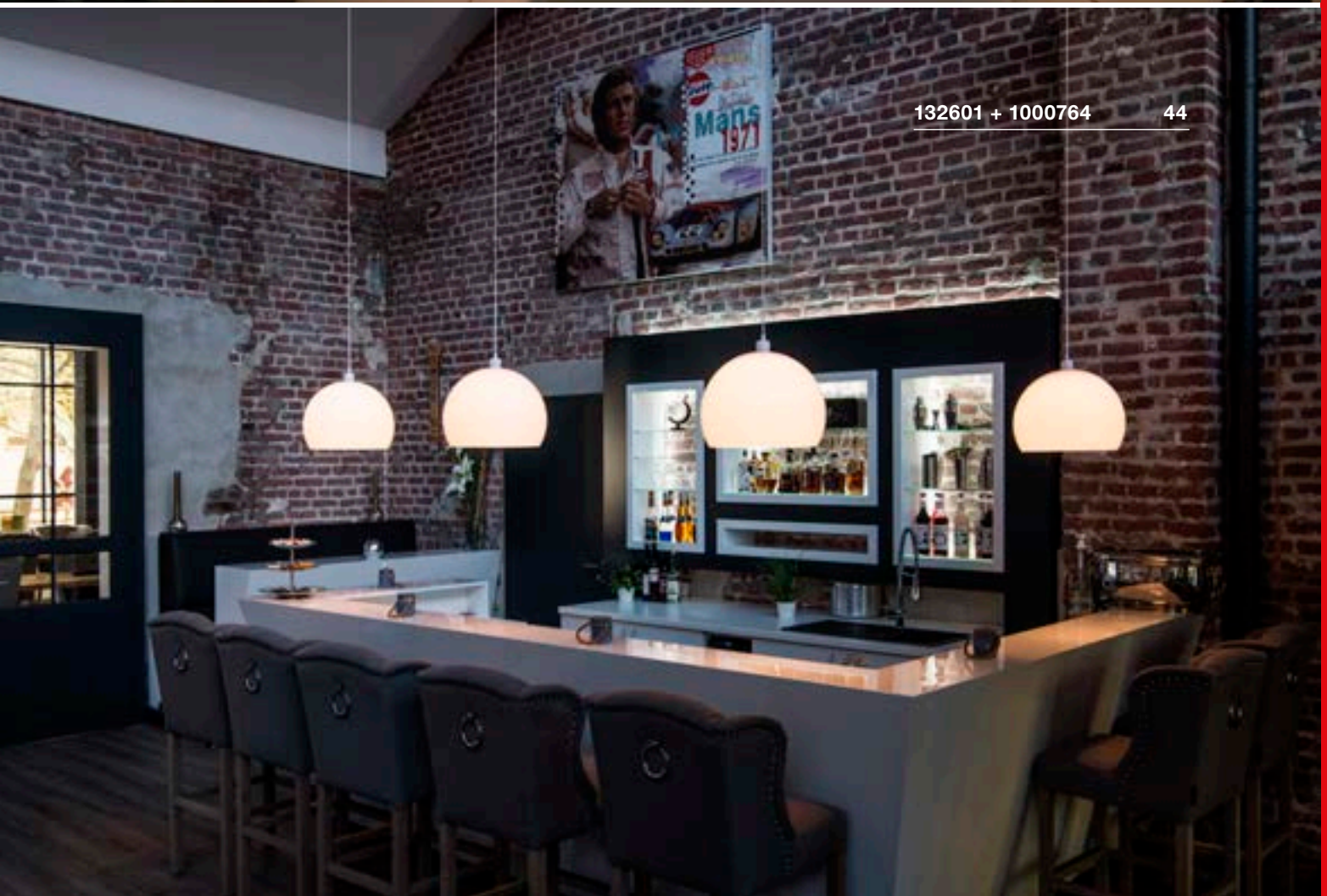

132601 + 1000764

44

FENDA
Ø 15 cm, round



MIX & MATCH



- Individually configurable by selecting a suitable lamp base

Product details

Material: Textile / Steel



Dimensioned drawing

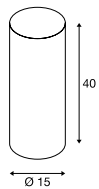

Note

max. 40W

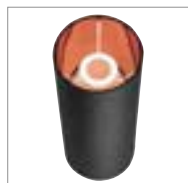

Variant	Item no.
white	156141
beige	156143
black / copper	156152

132605 + 156143 40 + 46

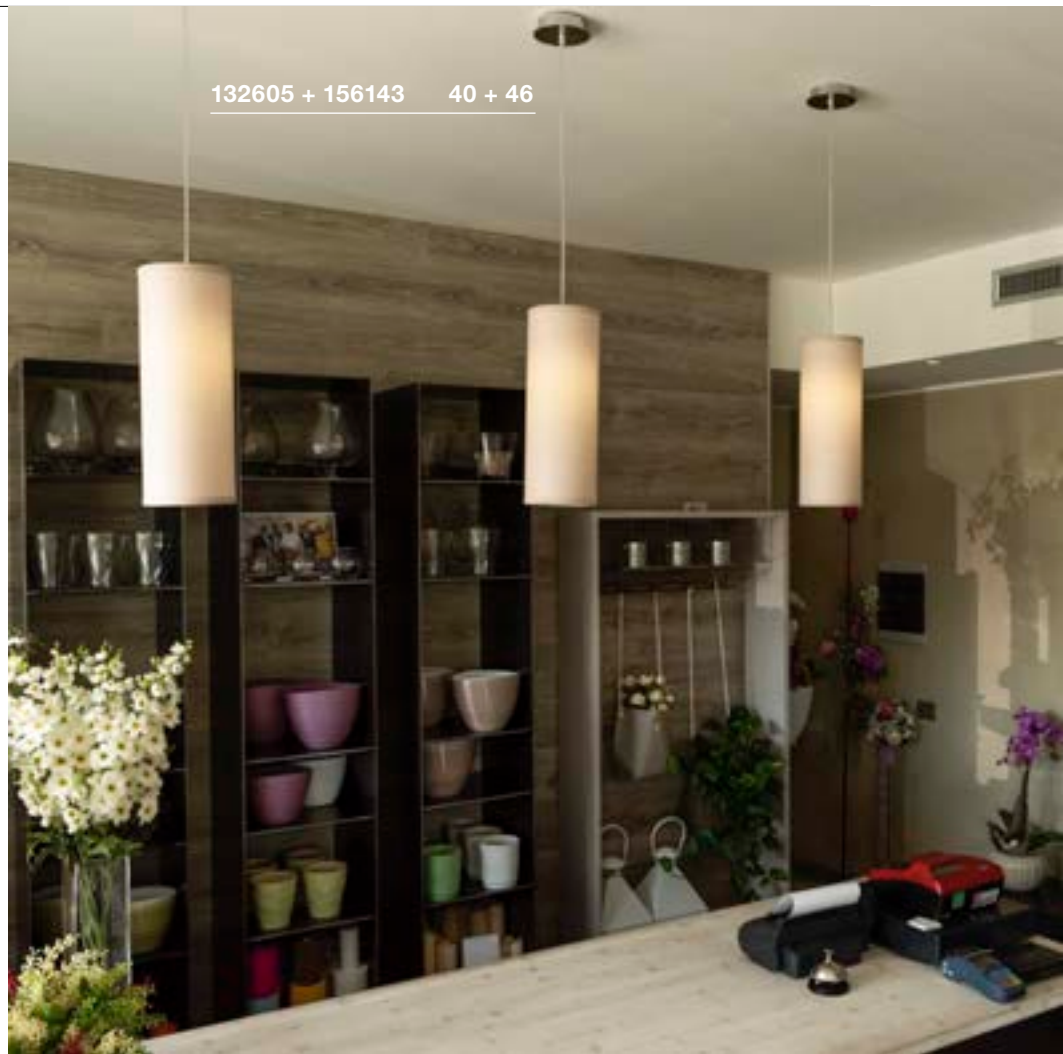

156122 47

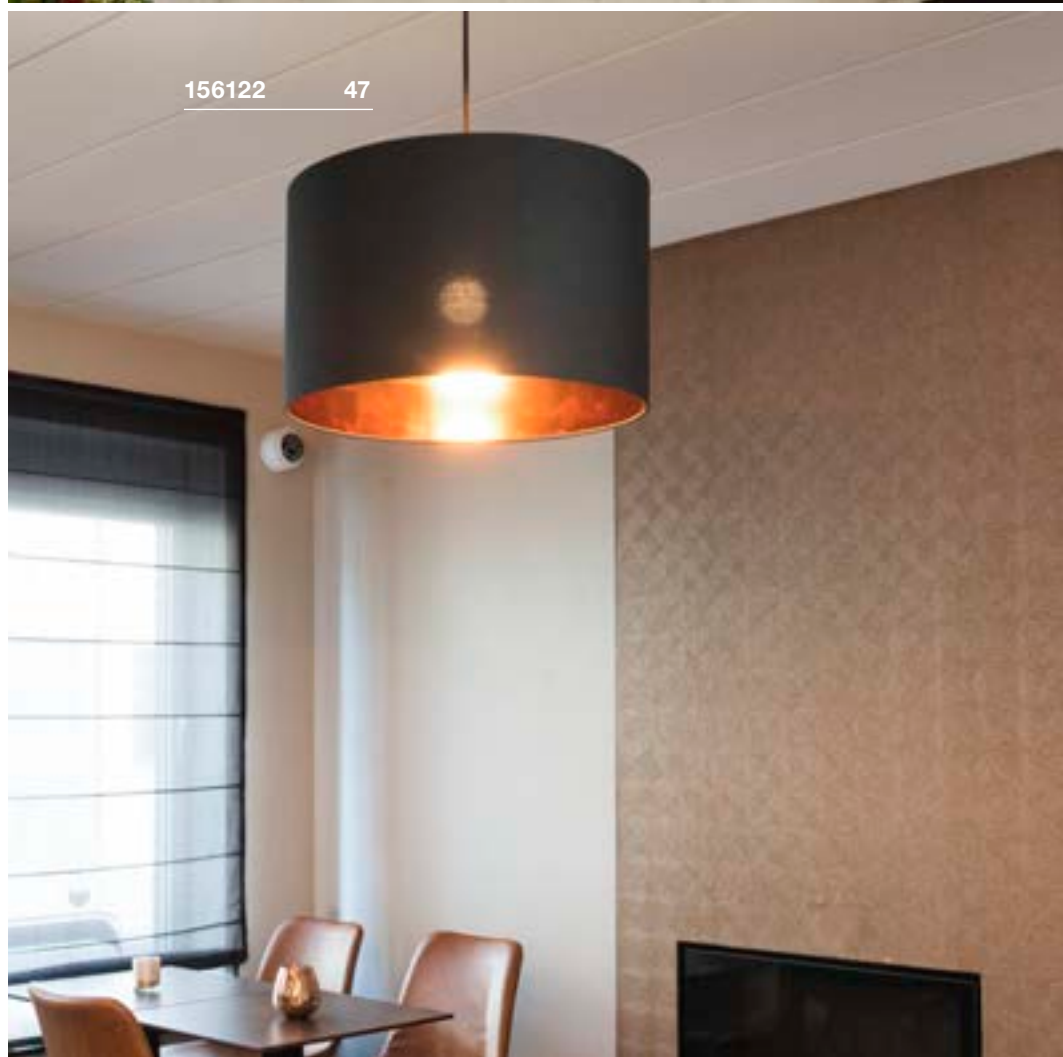

FENDA
Ø 30 cm, round



- Individually configurable by selecting a suitable lamp base

Product details

Material: Textile / Steel



Dimensioned drawing

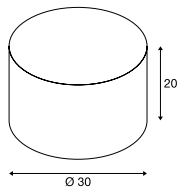

Note

max. 60W
Acrylic cover (155570) available as an accessory for covering the shade at one side



Recommended accessories

Acrylic cover
Item no. 155570

Variant	Item no.
<input type="checkbox"/> white	155582
<input type="checkbox"/> beige	155583
<input type="checkbox"/> black / copper	155592

FENDA
Ø 45 cm, round



- Individually configurable by selecting a suitable lamp base

Product details

Material: Textile / Steel



Dimensioned drawing

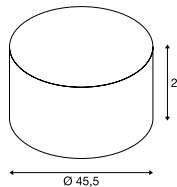

Note

max. 60W
Acrylic cover (156100) available as an accessory for covering the shade at one side



Recommended accessories

Acrylic cover
Item no. 156100

Variant	Item no.
<input type="checkbox"/> white	156111
<input type="checkbox"/> beige	156113
<input type="checkbox"/> black / copper	156122

FENDA
Ø 70 cm, round



- Individually configurable by selecting a suitable lamp base

Product details

Material: Textile / Steel



Dimensioned drawing

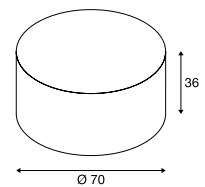

Note

max. 60W
Acrylic cover (1000957) available as an accessory for covering the shade at one side

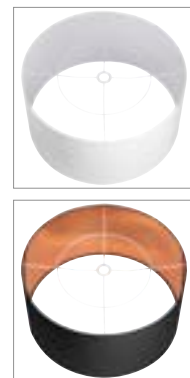

Recommended accessories

Acrylic cover
Item no. 1000957

Variant	Item no.
<input type="checkbox"/> white	1000579
<input type="checkbox"/> black / copper	1000580

PLASTRA 25
PD, cone, TCR-TSE



893

B-A++ Range
A++-E



- Can be individually designed with colours, stickers and more

Product details

230V ~50Hz
Material: Plaster / Steel

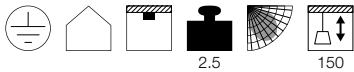

2.5

150

Dimensioned drawing

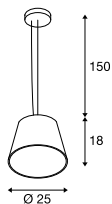

Recommended lamp

GX53 7.5W 120°
3000K 620lm EEL=A+
8kWh/1000h
Item no. 1001220



LED GX53 4.2W 35°
3000K 200lm EEL=A
5kWh/1000h
Item no. 550092



Lamp details

max. 11W TCR-TSE

Variant	Item no.
GX53 TCR-TSE	
<input type="checkbox"/> white	1000782

1000782 48

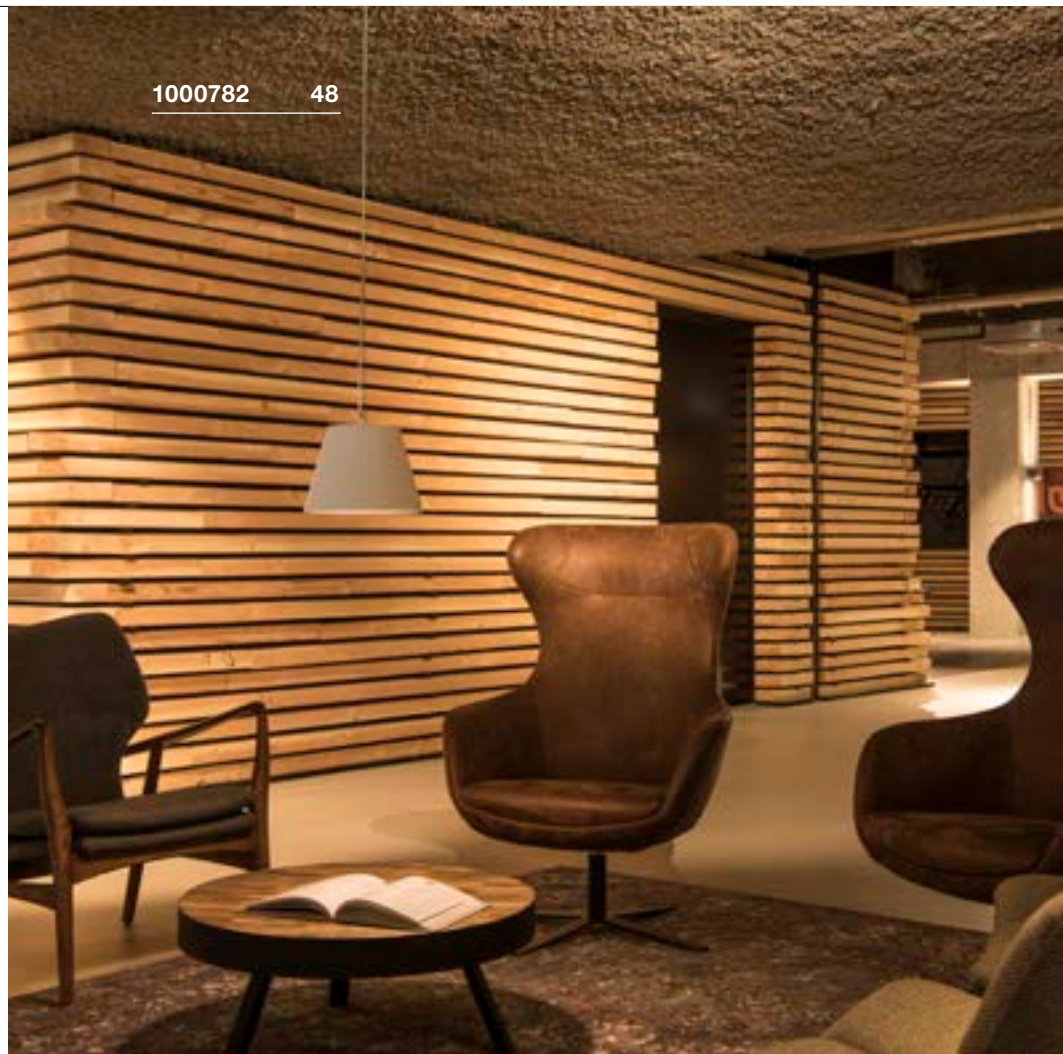

148040 49





148040 49



1002047 49

PLASTRA 25
PD, TCR-TSE



B-A++ Range A++-E



- Can be individually designed with colours, stickers and more

Product details

230V ~50Hz
Material: Plaster / Steel

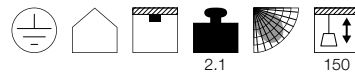

2.1 150

Dimensioned drawing

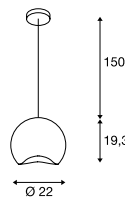

Recommended lamp

GX53 7.5W 120°
4000K 620lm EEL=A+
8kWh/1000h
Item no. 1001221



LED GX53 7.5W 25°
3000K 450lm EEL=A
8kWh/1000h
Item no. 550082



Lamp details

max. 11W TCR-TSE

Variant	Item no.
GX53 TCR-TSE □ white	148040

PLASTRA 25
PD, round, TCR-TSE



B-A++ Range A++-E



- Can be individually designed with colours, stickers and more

Product details

230V ~50Hz
Material: Plaster / Steel

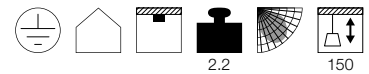

2.2 150

Dimensioned drawing

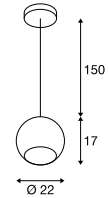

Recommended lamp

GX53 7.5W 120°
4000K 620lm EEL=A+
8kWh/1000h
Item no. 1001221



LED GX53 7.5W 25°
3000K 450lm EEL=A
8kWh/1000h
Item no. 550082



Lamp details

max. 11W TCR-TSE

Variant	Item no.
GX53 TCR-TSE □ white	1002047

LIGHT EYE® 90
PD, GU10



E-A++ Range A++-E



• The optimal deco ring for the lamp in the appropriate colour reduces the distance between housing and lamp

Product details

220-240V ~50/60Hz
Material: Steel

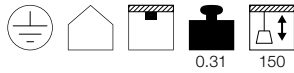

0.31 150

Dimensioned drawing

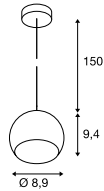

Note

Textile cable

Recommended accessories

- Lamp deco ring diam. 5.7cm
Item no. 151040
- Lamp deco ring diam. 5.7cm
Item no. 151041
- Lamp deco ring diam. 5.7cm
Item no. 151049



Recommended lamp

GU10 5.5W 36°
2800K 420lm EEL=A+
6kWh/1000h
Item no. 1001217



Lamp details

max. 6W LED GU10 51mm

Variant	Item no.
GU10 LED GU10 51mm ■ black / chrome	133490
GU10 LED GU10 51mm □ white / chrome	133491
GU10 LED GU10 51mm ■ gold	133493
GU10 LED GU10 51mm ■ copper	133499

LIGHT EYE® 150
PD, QPAR111



E-A++ Range A++-E



Product details

220-240V ~50/60Hz
Material: Steel

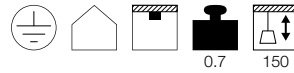

0.7 150

Dimensioned drawing

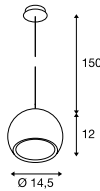

Note

Textile cable

Recommended lamp

GU10 15.5W 30°
2700K 680lm EEL=A
6kWh/1000h
Item no. 570672



Lamp details

max. 75W QPAR111

Variant	Item no.
GU10 QPAR111 □ white / chrome	133481
GU10 QPAR111 ■ chrome	133482
GU10 QPAR111 ■ gold	133483
GU10 QPAR111 ■ copper	133489

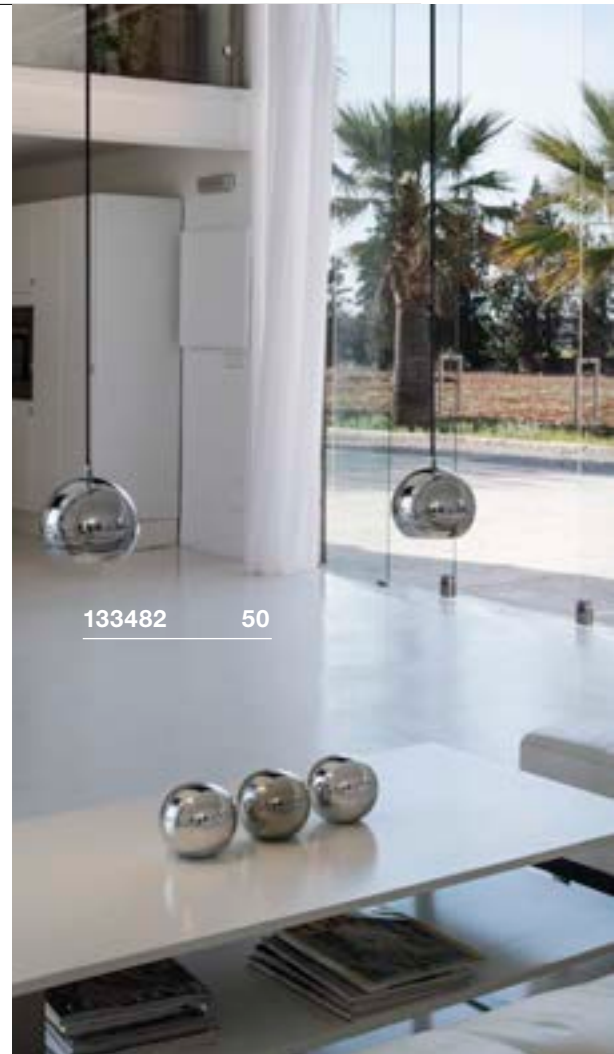

133482 50



133489 50



133481 50



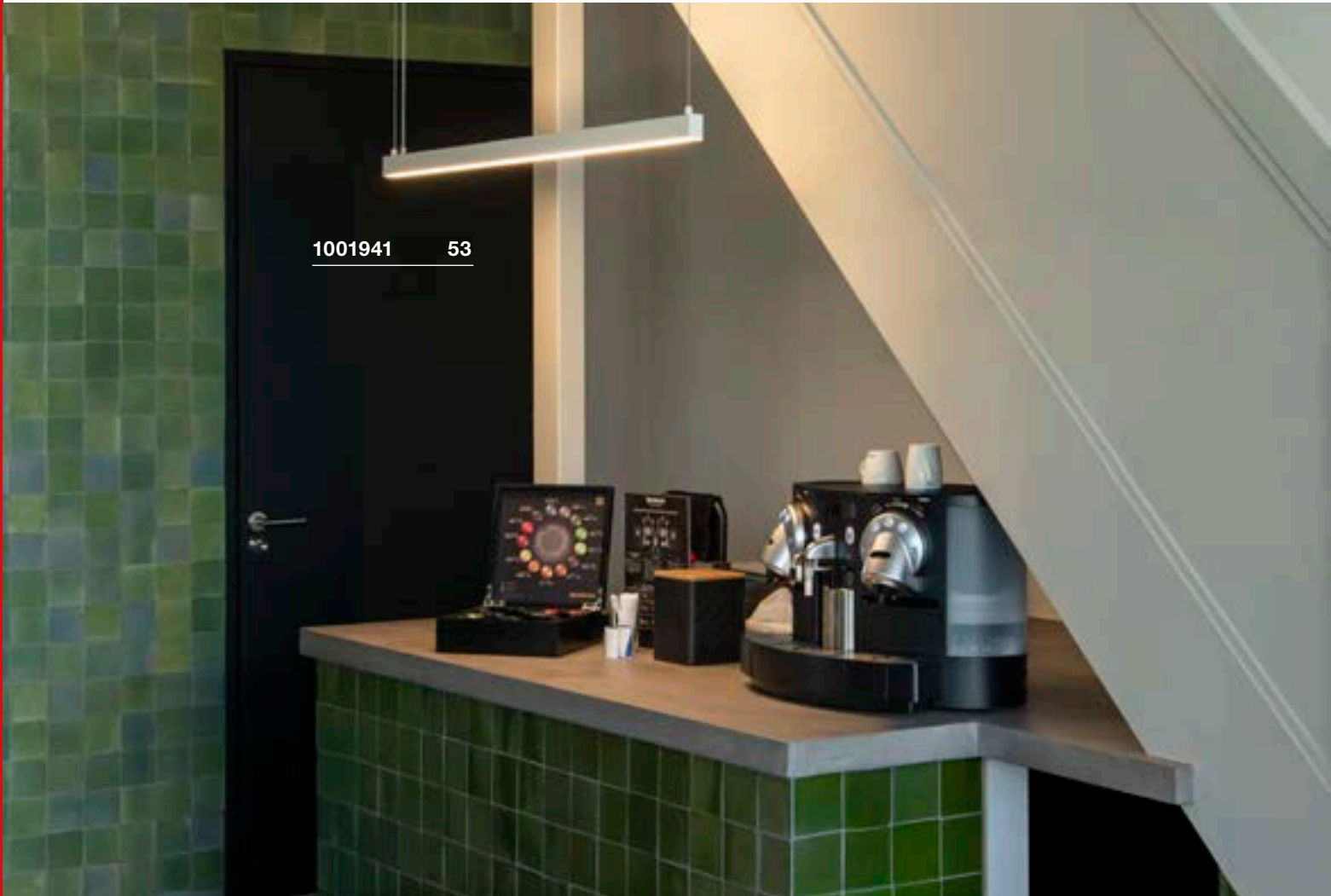

VINCELLI D
PD, TRIAC



A-A++ Range A++-E

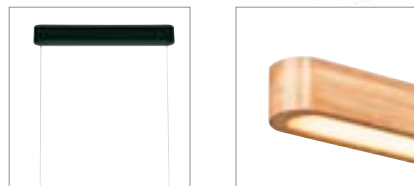

- Slim design
- Lamp body made from real bamboo

Product details

220-240V ~50/60Hz | 700mA
Total consumption: 29W
Material: Bamboo / Steel
Dimmable: Triac C, Triac L

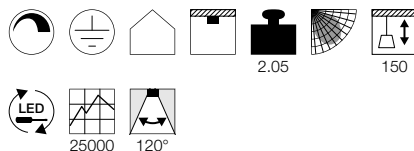

Dimensioned drawing

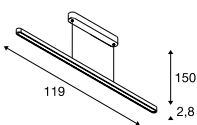

Variant	Item no.
1400lm 2700K CRI>80 ■ bamboo / black	156268

AROSA
PD, 1.25m, TRIAC

A-A++ Range A++-E



- Straight-lined design
- Direct and indirect light

Product details

220-240V ~50/60Hz | 500mA
Total consumption: 32W
Material: Aluminium / Polymethylacrylate (PMMA)
Dimmable: Triac C

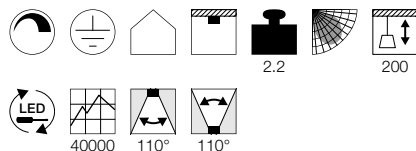

Dimensioned drawing

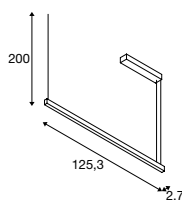

Variant	Item no.
Up: 750lm 3000K CRI>80 Down: 950lm 3000K CRI>80 ■ black	1001940
Up: 750lm 3000K CRI>80 Down: 950lm 3000K CRI>80 □ matt white	1001941
Up: 750lm 3000K CRI>80 Down: 950lm 3000K CRI>80 □ aluminium	1001942

AROSA
PD, 2m, TRIAC

A-A++ Range A++-E

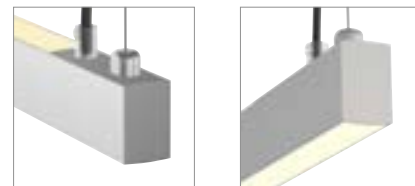
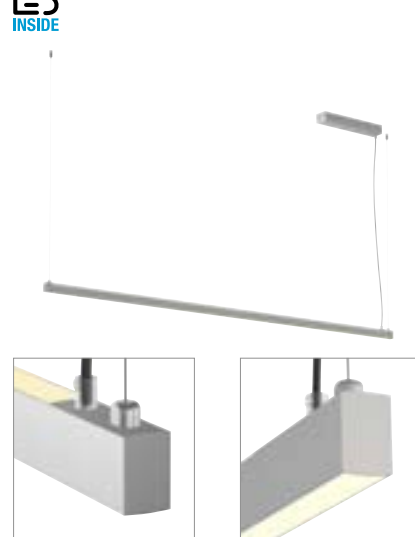

- Straight-lined design
- Direct and indirect light

Product details

220-240V ~50/60Hz | 600mA
Total consumption: 65W
Material: Aluminium / Polymethylacrylate (PMMA)
Dimmable: Triac C

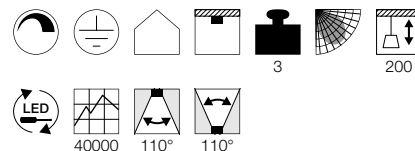

Dimensioned drawing

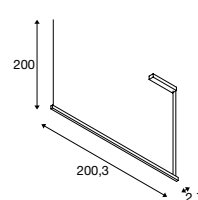

Variant	Item no.
Up: 1800lm 3000K CRI>80 Down: 1800lm 3000K CRI>80 ■ black	1001943
Up: 1800lm 3000K CRI>80 Down: 1800lm 3000K CRI>80 □ matt white	1001944
Up: 1800lm 3000K CRI>80 Down: 1800lm 3000K CRI>80 □ aluminium	1001945

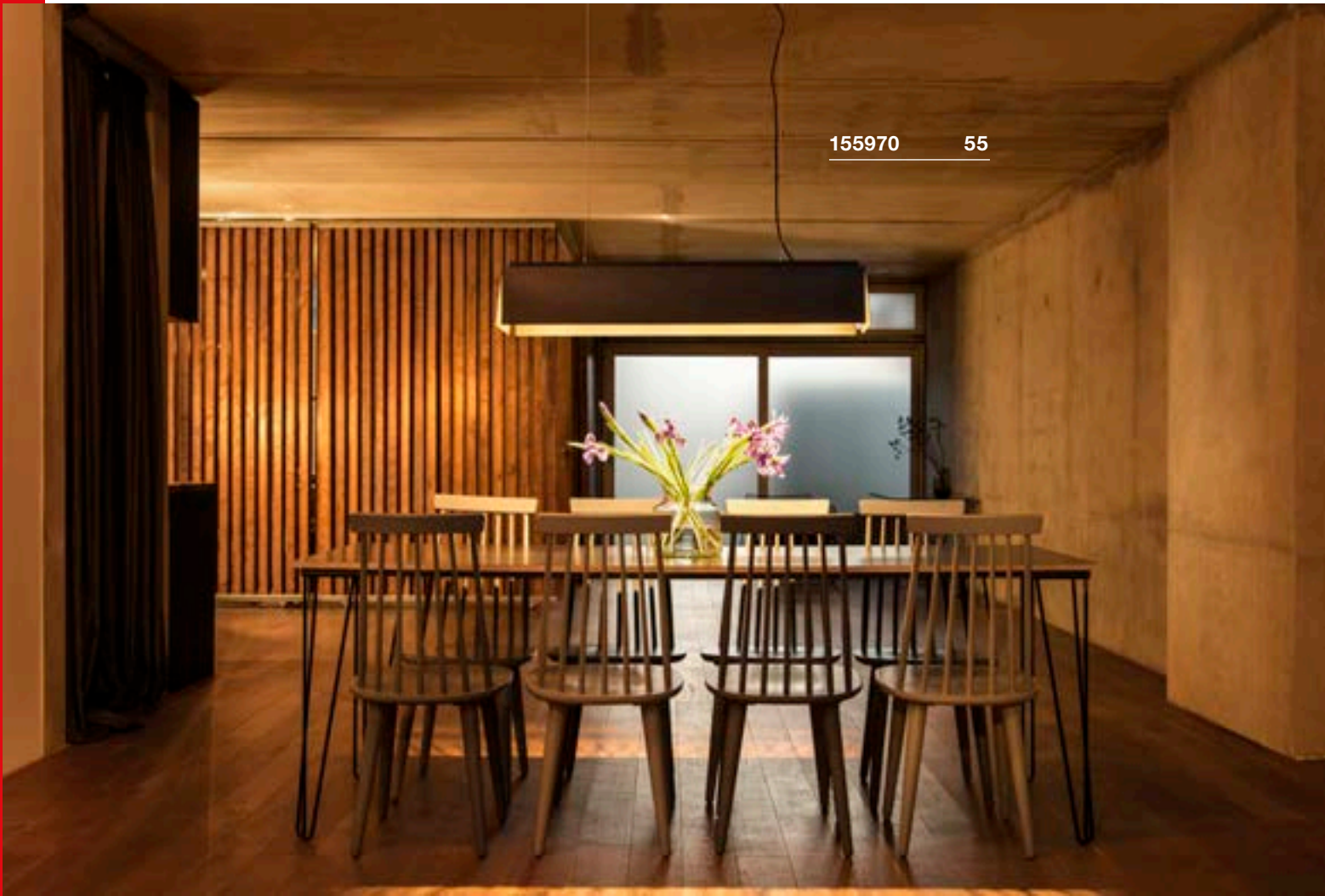

155970 55

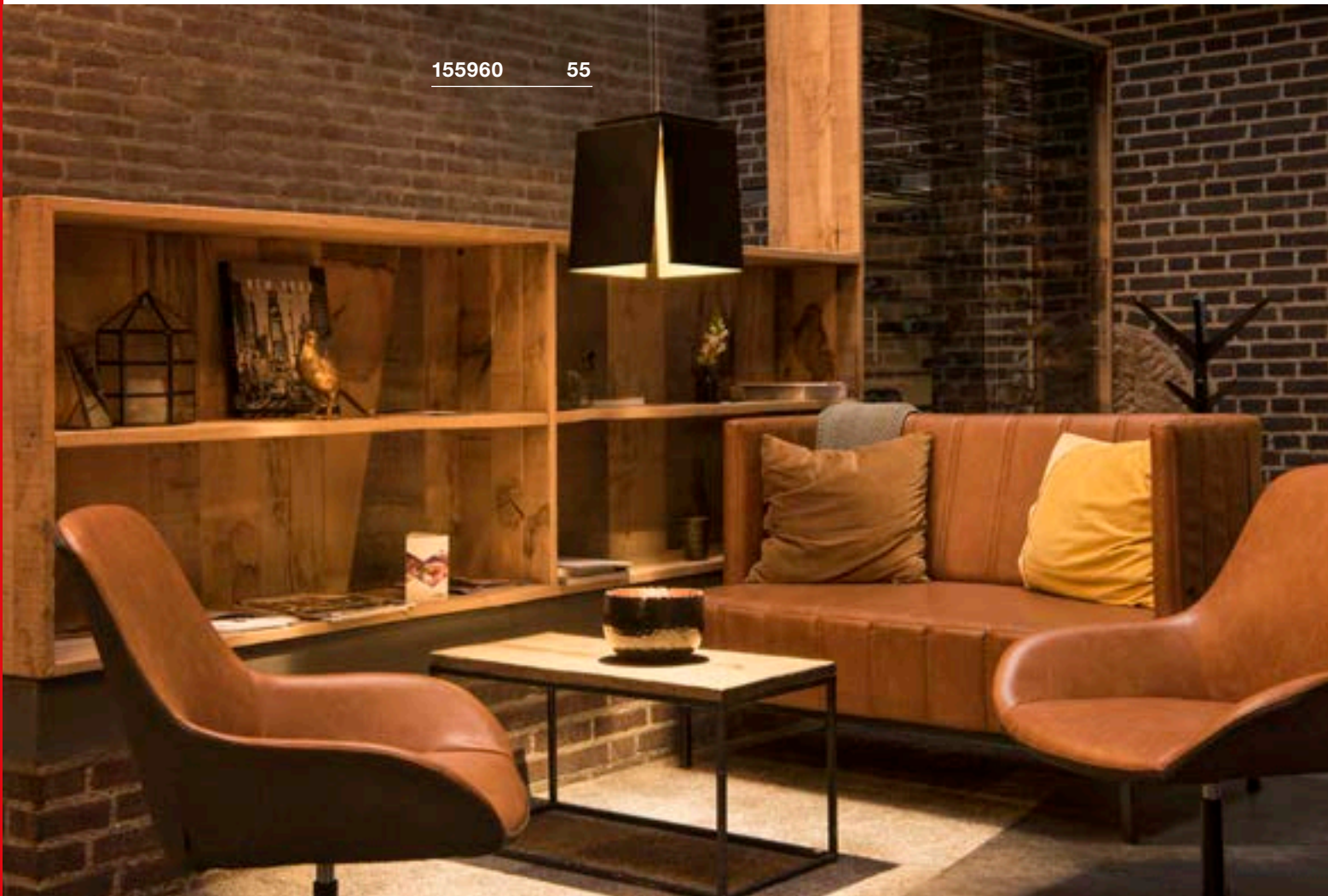

155960 55



155960 55



155960 55

AVENTO 30 PD

A-A++ Range A++-E
LED INSIDE



- Structured inner coating in gold colour

Product details

220-240V ~50/60Hz | 350mA
Total consumption: 15W
Material: Aluminium
Dimmable: Triac C

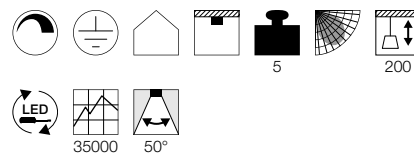

Dimensioned drawing

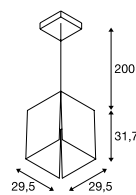

Note

Textile cable

Variant	Item no.
660lm 3000K CRI>80 ■ black / gold	155960

AVENTO 110 PD

A-A++ Range A++-E
LED INSIDE



- Structured inner coating in gold colour

Product details

220-240V ~50/60Hz | 700mA
Total consumption: 29W
Material: Aluminium
Dimmable: Triac C

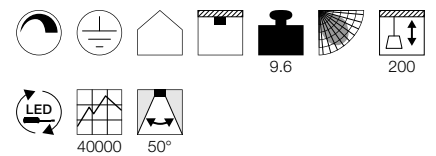

Dimensioned drawing

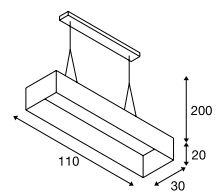

Note

Textile cable

Variant	Item no.
2500lm 3000K CRI>80 ■ black / gold	155970

PHELIA
PD, E27



893

A-A++ Range A++-E



- Individual lamp head design
- Can be combined into a "lighting group" by means of individual configuration

Product details

220-240V ~50/60Hz
Material: Aluminium

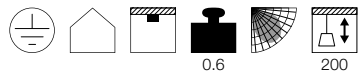

Dimensioned drawing

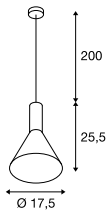

Note

Textile cable

Recommended lamp

LED E27 14.5W 200°
2700K 1521lm EEI=A+
15kWh/1000h
Item no. 1002126



LED E27 9,1W 240°
2700K 760lm EEK=A+
10kWh/1000h
Item no. 560402



Lamp details

max. 23W

Variant	Item no.
E27 ■ black / gold	1002948
E27 ■ black / white	133300
E27 □ white	1002136



1002948 56

1002951 57

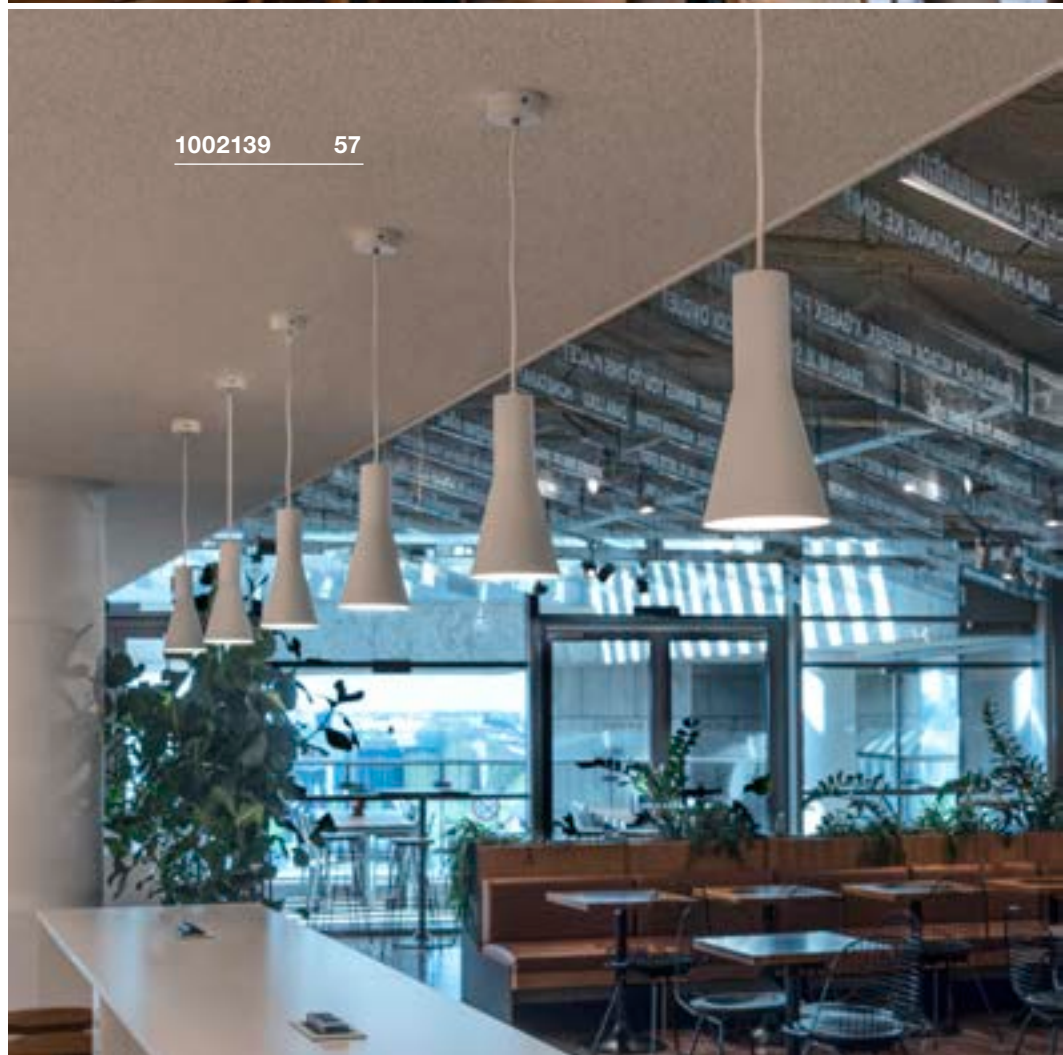

1002139 57

PHELIA
PD, E27



A-A++ Range A++-E



- Individual lamp head design
- Can be combined into a "lighting group" by means of individual configuration

Product details

220-240V ~50/60Hz
Material: Aluminium

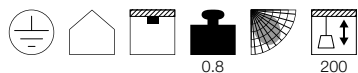

Dimensioned drawing

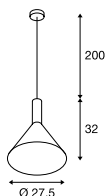

Note

Textile cable

Recommended lamp

LED E27 4W 180°
2000-2900K 200lm EEI=A
4kWh/1000h
Item no. 1002126



LED E27 9,1W 240°
2700K 760lm EEK=A+
10kWh/1000h
Item no. 560402



Lamp details

max. 23W

Variant	Item no.
E27 ■ black / gold	1002949
E27 ■ black / white	133310
E27 □ white	1002137

PHELIA
PD, E27



A-A++ Range A++-E



- Individual lamp head design
- Can be combined into a "lighting group" by means of individual configuration

Product details

220-240V ~50/60Hz
Material: Aluminium

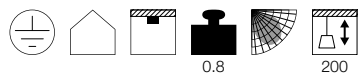

Dimensioned drawing

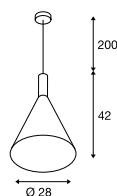

Note

Textile cable

Recommended lamp

LED E27 7.1W 330°
2700K 806lm EEI=A+
8kWh/1000h
Item no. 1002126



LED E27 9,1W 240°
2700K 760lm EEK=A+
10kWh/1000h
Item no. 560402



Lamp details

max. 23W

Variant	Item no.
E27 ■ black / gold	1002950
E27 ■ black / white	133320
E27 □ white	1002138

PHELIA
PD, E27



A-A++ Range A++-E



- Individual lamp head design
- Can be combined into a "lighting group" by means of individual configuration

Product details

220-240V ~50/60Hz
Material: Aluminium

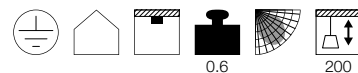

Dimensioned drawing

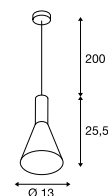

Note

Textile cable

Recommended lamp

LED E27 7W 280°
2200-2700K 830lm EEI=A++
7kWh/1000h
Item no. 1002126



LED E27 9,1W 240°
2700K 760lm EEK=A+
10kWh/1000h
Item no. 560402



Lamp details

max. 23W

Variant	Item no.
E27 ■ black / gold	1002951
E27 ■ black / white	133330
E27 □ white	1002139

BATO 35
PD, TRIAC



A-A++ Range A++-E



- Can be combined into a "lighting group" by means of individual configuration

Product details

220-240V ~50/60Hz | 500mA
Total consumption: 21W
Material: Aluminium / Polymethylacrylate (PMMA)
Dimmable: Triac C

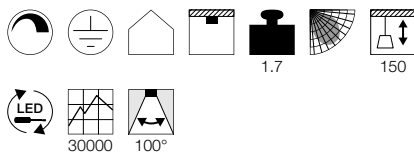

Dimensioned drawing

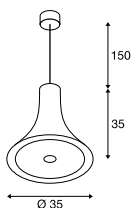

Note

Textile cable

BATO 35
PD, E27



E-A++ Range A++-E

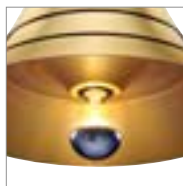

- Can be combined into a "lighting group" by means of individual configuration

Product details

220-240V ~50/60Hz
Material: Aluminium / Steel

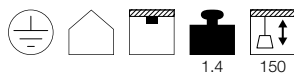

Dimensioned drawing

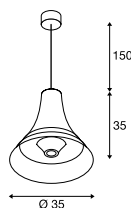

Note

Textile cable

Recommended lamp

LED E27 7W 280°
2700K 790lm EEL=A++
7kWh/1000h
Item no. 1002124



LED E27 7W 180°
2700K 630lm EEL=A+
8kWh/1000h
Item no. 1001357



Lamp details

max. 60W

Variant	Item no.
1300lm 2700K CRI>80 ■ black / matt brass	1001351
1300lm 2700K CRI>80 ■ black	1000436
1500lm 2500K CRI>80 ■ matt brass	1000441

Variant	Item no.
E27 ■ black / matt brass	1001266
E27 ■ black	1000434
E27 ■ matt brass	1000439

BATO 45
PD, TRIAC



A-A++ Range A++-E



- Can be combined into a "lighting group" by means of individual configuration

Product details

220-240V ~50/60Hz | 700mA
Total consumption: 30W
Material: Aluminium / Polymethylacrylate (PMMA)
Dimmable: Triac C

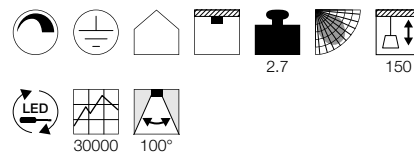

Dimensioned drawing

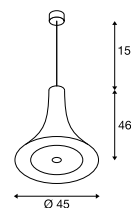

Note

Textile cable

Variant	Item no.
1450lm 2700K CRI>80 ■ black / matt brass	1001350
1450lm 2700K CRI>80 ■ black	1000435
1900lm 2500K CRI>80 ■ matt brass	1000440

BATO 45
PD, E27



E-A++ Range
A++-E



- Can be combined into a "lighting group" by means of individual configuration

Product details

220-240V ~50/60Hz
Material: Aluminium / Steel

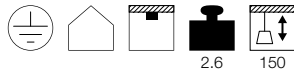

Dimensioned drawing

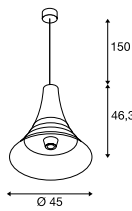

Note

Textile cable

Recommended lamp

LED E27 7W 280°
2700K 790lm EEL=A++
7kWh/1000h
Item no. 1002124



LED E27 7W 180°
2700K 630lm EEL=A+
8kWh/1000h
Item no. 1001357



Lamp details

max. 60W

Variant	Item no.
E27	
■ black / matt brass	1001265
E27	
■ black	1000433
E27	
■ matt brass	1000438

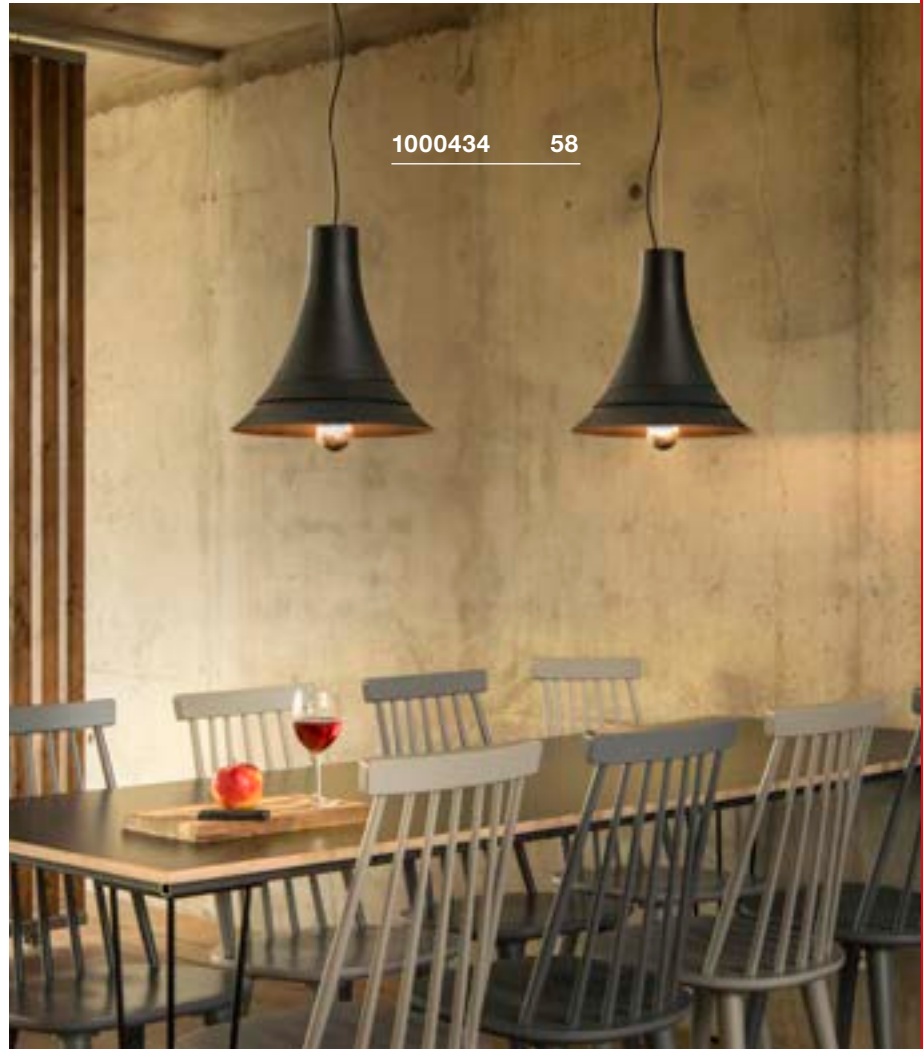

133897 61





143430 391

133887 61



133886 61

BELA 40 PD

A-A++ Range A++-E



- Reduced glare due to diffuse illumination surface

Product details

220-240V ~50/60Hz | 700mA
 Total consumption: 24W
 Material: Aluminium / Polymethylacrylate (PMMA)

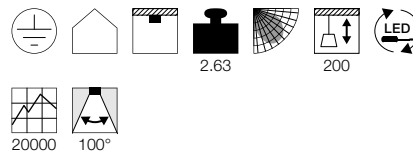

Dimensioned drawing

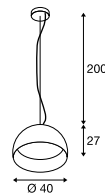

Note

Textile cable

Variant	Item no.
1350lm 3000K CRI>80 □ white	133881
1350lm 3000K CRI>80 ■ black / white	133886
1350lm 3000K CRI>80 ■ black / gold	133887

BELA 60 PD

A-A++ Range A++-E



- Reduced glare due to diffuse illumination surface

Product details

220-240V ~50/60Hz | 700mA
 Total consumption: 31W
 Material: Aluminium / Polymethylacrylate (PMMA)

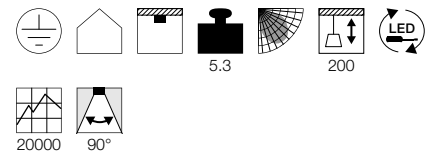

Dimensioned drawing

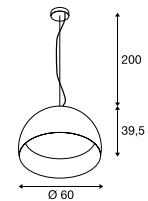

Note

Textile cable

Variant	Item no.
1850lm 3000K CRI>80 □ white	133891
1850lm 3000K CRI>80 ■ black / white	133896
1850lm 3000K CRI>80 ■ black / gold	133897

FORCHINI 40
PD, E27



E-A++ Range A++-E



- Every luminaire interior pattern is unique
- Textile cable in housing colour

Product details

230V ~50Hz
Material: GRP

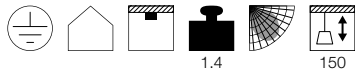

1.4 150

Dimensioned drawing

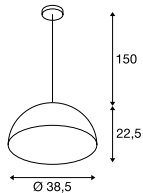

Recommended lamp

LED E27 7W 330°
2700K 806lm EEL=A+
8kWh/1000h
Item no. 1001035



Lamp details

max. 40W
L: 14 cm max.

Variant	Item no.
E27	
■ black / grey	155500
E27	
■ black / gold	155510
E27	
■ white/gold	155511

FORCHINI 50
PD, E27



E-A++ Range A++-E



- Every luminaire interior pattern is unique
- Textile cable in housing colour

Product details

230V ~50Hz
Material: GRP

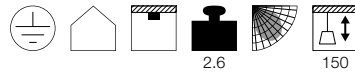

2.6 150

Dimensioned drawing

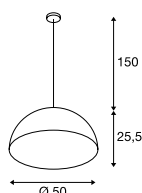

Recommended lamp

LED E27 7W 330°
2700K 806lm EEL=A+
8kWh/1000h
Item no. 1001035



LED E27 7W 280°
2200-2700K 830lm EEL=A++
7kWh/1000h
Item no. 1002126



Lamp details

max. 40W
L: 20 cm max.

Variant	Item no.
E27	
■ black / grey	155520
E27	
■ black / gold	155530
E27	
■ white/gold	155531

FORCHINI 70
PD, E27



E-A++ Range A++-E



- Every luminaire interior pattern is unique
- Textile cable in housing colour

Product details

220-240V ~50/60Hz
Material: GRP

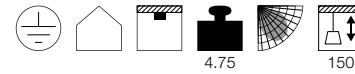

4.75 150

Dimensioned drawing

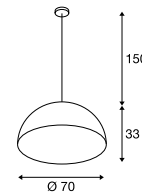

Recommended lamp

LED E27 8W 180°
2000-2900K 400lm EEL=A
8kWh/1000h
Item no. 1001035



LED E27 8W
2000-2900K 500lm EEL=A
8kWh/1000h
Item no. 1001038



Lamp details

max. 40W
L: 20 cm max.

Variant	Item no.
E27	
■ black / gold	1001701

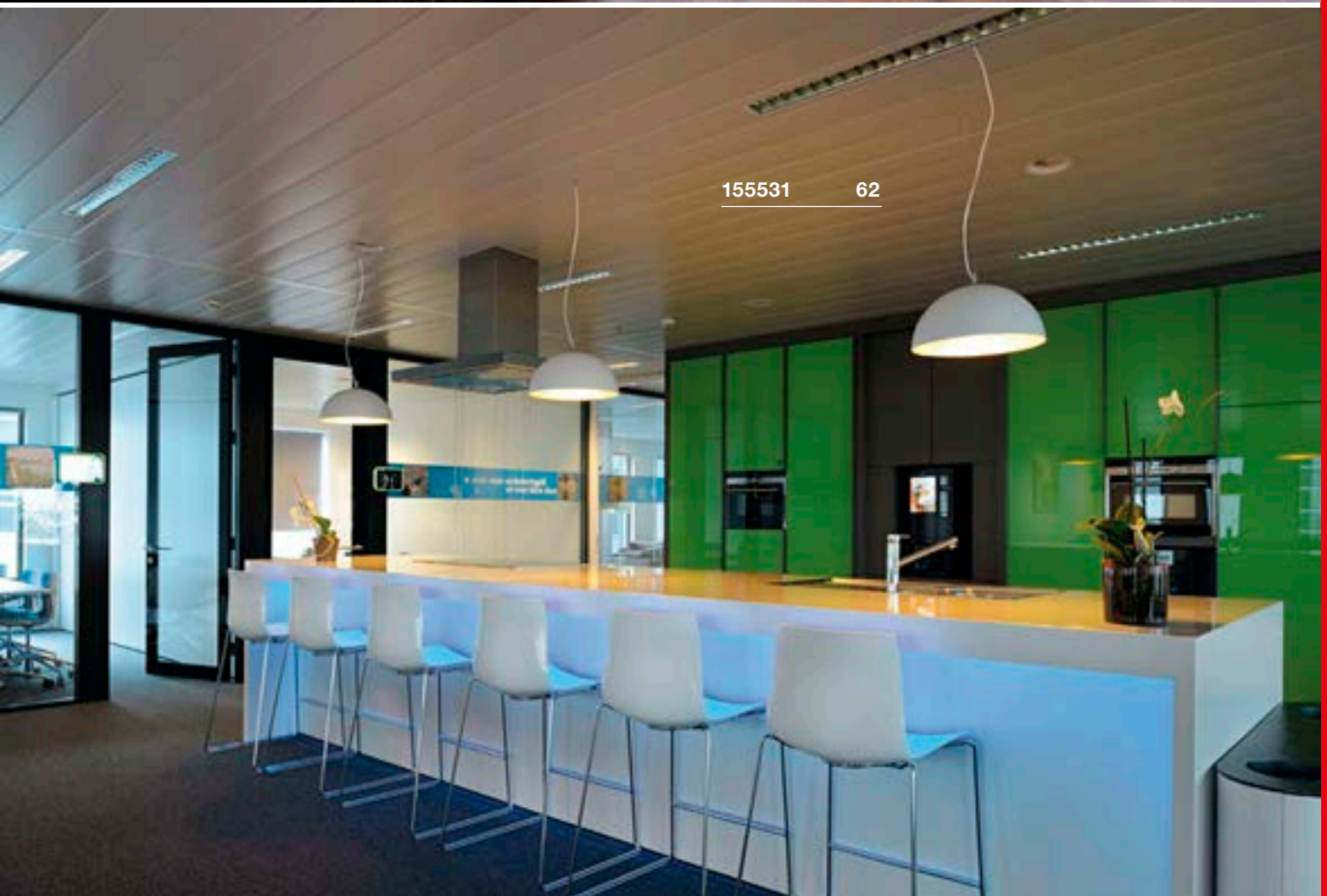

1555930 65





155910 65



155901 65

FORCHINI M 40
PD, E27



E-A++ Range A++-E



- Textured interior design with internal reflector
- Textile cable in housing colour

Product details

230V ~50Hz
Material: Aluminium / Steel

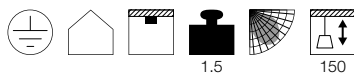

Dimensioned drawing

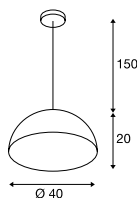

Recommended lamp

LED E27 7W 330°
2700K 806lm EEL=A+
8kWh/1000h
Item no. 1001035



LED E27 7W 280°
2200-2700K 830lm EEL=A++
7kWh/1000h
Item no. 1002126



Lamp details

max. 40W
L: 15.2 cm max.

Variant	Item no.
E27	
■ black / grey	155900
E27	
■ white / grey	155901
E27	
■ black / gold	155910
E27	
■ white/gold	155911

FORCHINI M 50
PD, E27



E-A++ Range A++-E



- Textured interior design with internal reflector
- Textile cable in housing colour

Product details

230V ~50Hz
Material: Aluminium / Steel

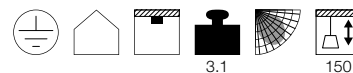

Dimensioned drawing

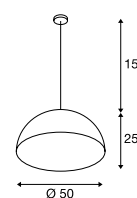

Recommended lamp

LED E27 7W 330°
2700K 806lm EEL=A+
8kWh/1000h
Item no. 1001038



LED E27 7W 280°
2200-2700K 830lm EEL=A++
7kWh/1000h
Item no. 1002126



Lamp details

max. 40W
L: 18 cm max.

Variant	Item no.
E27	
■ black / grey	155920
E27	
■ white / grey	155921
E27	
■ black / gold	155930
E27	
■ white/gold	155931

PARA CONE 20
PD, E27

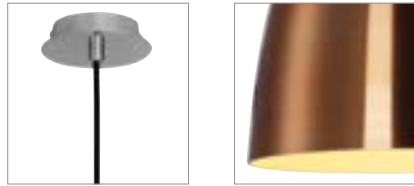

- Can be combined into a "lighting group" by means of individual configuration
- Wide range of colours and sizes

Product details

220-240V ~50/60Hz
Material: Aluminium / Steel



Dimensioned drawing

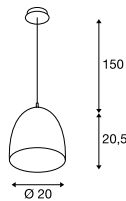

Note

Textile cable
black / gold version with gold reflex or

Recommended lamp

LED E27 7W 280°
2700K 790lm EEL=A++
7kWh/1000h
Item no. 1002124



Lamp details

max. 60W

Variant	Item no.
E27	
white	133001
E27	
matt aluminium	133005
E27	
copper	133009
E27	
black / gold	133050

PARA CONE 30
PD, E27

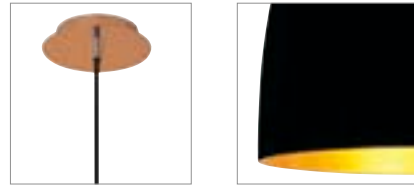

- Can be combined into a "lighting group" by means of individual configuration
- Wide range of colours and sizes

Product details

220-240V ~50/60Hz
Material: Aluminium / Steel

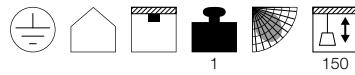

Dimensioned drawing

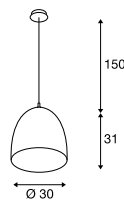

Note

Textile cable
black / gold version with gold reflex or

Recommended lamp

LED E27 4.8W 330°
2700K 470lm EEL=A++
5kWh/1000h
Item no. 560752



LED E27 9W 240°
2700-6500K 806lm EEL=A+
9kWh/1000h
Item no. 1001916



Lamp details

max. 60W

Variant	Item no.
E27	
white	133011
E27	
matt aluminium	133015
E27	
copper	133019
E27	
black / gold	133060

PARA CONE 40
PD, E27



- Can be combined into a "lighting group" by means of individual configuration
- Wide range of colours and sizes

Product details

220-240V ~50/60Hz
Material: Aluminium / Steel

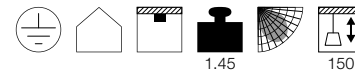

Dimensioned drawing

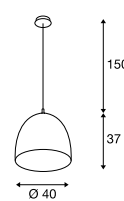

Note

Textile cable
black / gold version with gold reflex or

Recommended lamp

LED E27 7W 330°
2700K 806lm EEL=A+
8kWh/1000h
Item no. 1001038



LED E27 7W 180°
2700K 630lm EEL=A+
8kWh/1000h
Item no. 1001357



Lamp details

max. 60W

Variant	Item no.
E27	
white	155471
E27	
matt aluminium	155475
E27	
copper	155479
E27	
black / gold	133070

MALANG
CW, SLV VALETO®



- Can be integrated in the SLV VALETO® system and other ZigBee® systems
- Panel can be controlled separately from warm white to cool white and dimmed
- The ring can be controlled separately in RGBW colours and dimmed

Product details

100-240V ~50/60Hz | 24V DC
Total consumption: 39W
Material: Aluminium / Polycarbonate (PC)

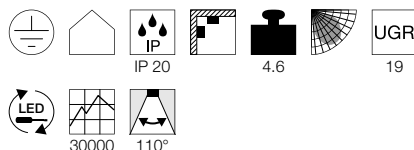

Dimensioned drawing

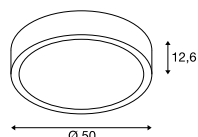

Note

Can be remote controlled and dimmed using SLV VALETO® CCT/RGBW remote control [1002994] or Gateway [1002411]

Recommended accessories

- Suspension set 1.5m
Item no. 135250
- Suspension set 1.5m
Item no. 135251
- Suspension set 1.5m
Item no. 135254
- Suspension set 5m
Item no. 1001950
- Suspension set 5m
Item no. 1001951
- Suspension set 5m
Item no. 1001952
- Remote control CCT/RGBW
Item no. 1002994

Variant	Item no.
Ring: 350lm RGB+W (3000K) CRI>80 Panel: 2100-2400lm 2700-6500K CRI>80 □ white	1002858

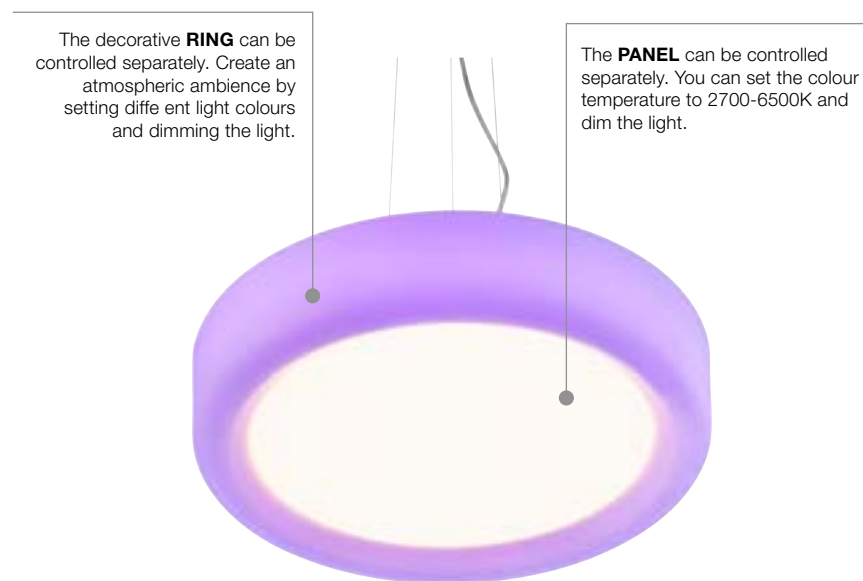

With our SLV VALETO® SMART LIGHT SYSTEM the choice is yours: Control your light at home with our SLV VALETO® remote control (1002994), or an app on your Smartphone via our SLV VALETO® Gateway (1002411).

Thanks to the latest ZigBee standard (ZigBee® 3.0) there are no limits to your smart light control.



Remote control
Item no. 1002994



Gateway
Item no. 1002411



SLV VALETO®
App

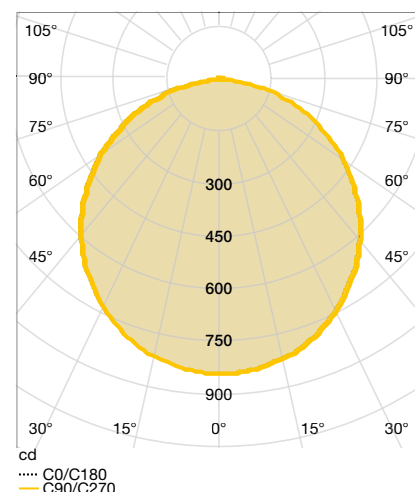
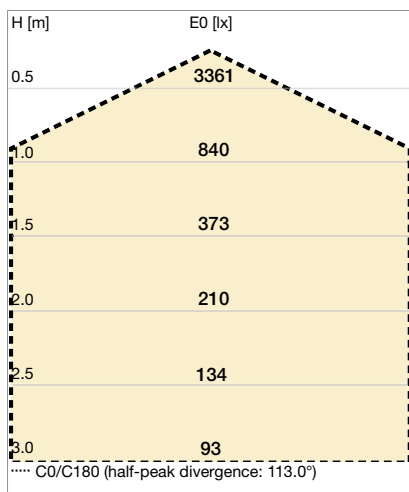

SPHERA 45
PD, TRIAC

A-A++ Range A++-E

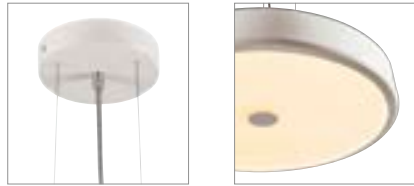

- Sleek lamp body
- High-gloss lacquered finis

Product details

220-240V ~50/60Hz | 350mA
Total consumption: 13W
Material: Aluminium / Acrylic
Dimmable: Triac C

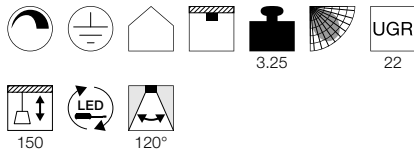

Dimensioned drawing

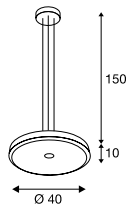

SPHERA 75
PD, TRIAC

A-A++ Range A++-E

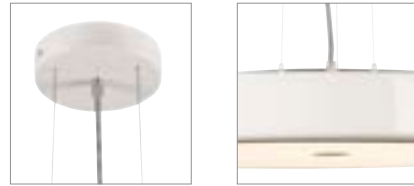

- Sleek lamp body
- High-gloss lacquered finis

Product details

220-240V ~50/60Hz | 500mA
Total consumption: 15W
Material: Aluminium / Acrylic
Dimmable: Triac C

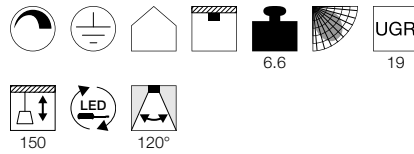

Dimensioned drawing

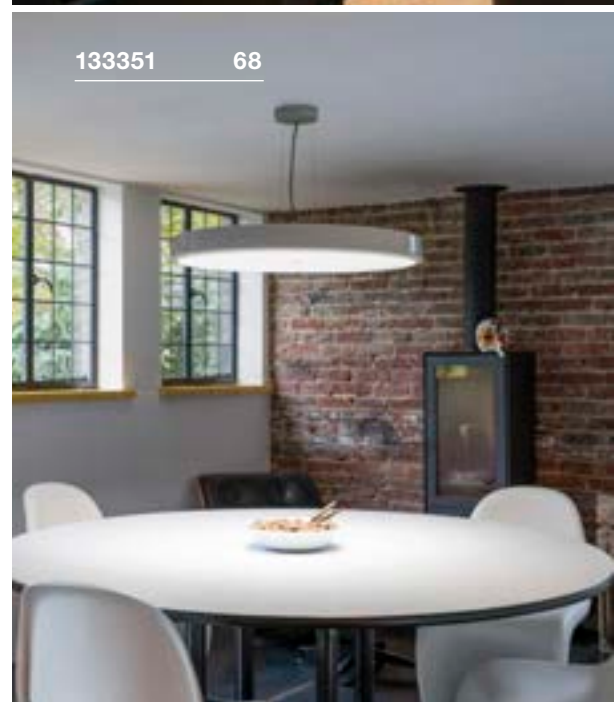
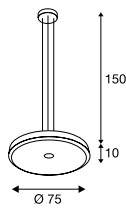

Variant	Item no.
800lm 2700K CRI>80	
□ white	133341

Variant	Item no.
1200lm 2700K CRI>80	
□ white	133351



1002937 69

ASTINA
PD, QPAR51

884

A-A++ Range
A++-E

NEW



- High-quality, frosted glass
- 2.5 m long cable

Product details

220-240V ~50/60Hz

Material: Aluminium

Product dimensions: Ø: 7 cm L: 20 cm



0.6 250

Note

Open cable end

Can be combined with the Fitu Mix & Match accessory on page 40

Lamp details

GU10 QPAR51 max. 10W

Variant	Item no.
GU10 QPAR51 □ matt white	1002937
GU10 QPAR51 ■ matt grey	1002938
GU10 QPAR51 ■ matt black	1002939

PLASTRA
PD, QPAR51



A-A++ Range A++-E



• Can be individually designed with colours, stickers and more

Product details

230V ~50Hz
Material: Plaster / Steel

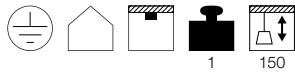

Dimensioned drawing

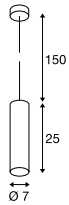

Recommended lamp

GU10 5.5W 36°
2800K 420lm EEL=A+
6kWh/1000h
Item no. 1001217



LED GU10 7W 25/40/55°
3000K 300lm EEL=A
7kWh/1000h
Item no. 560603



Lamp details

max. 7W QPAR51

Variant	Item no.
GU10 QPAR51 □ white	148042

ENOLA B
PD, QPAR51



E-A++ Range A++-E



Product details

220-240V ~50/60Hz
Material: Aluminium / Steel

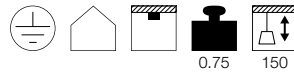

Dimensioned drawing

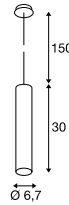

Recommended lamp

GU10 5.5W 36°
2800K 420lm EEL=A+
6kWh/1000h
Item no. 1001217



LED GU10 7W 25/40/55°
3000K 300lm EEL=A
7kWh/1000h
Item no. 560603



Lamp details

max. 50W QPAR51

Variant	Item no.
GU10 QPAR51 ■ black	151850
GU10 QPAR51 □ white	151851
GU10 QPAR51 ■ gold	151853
GU10 QPAR51 ■ grey / black	151854

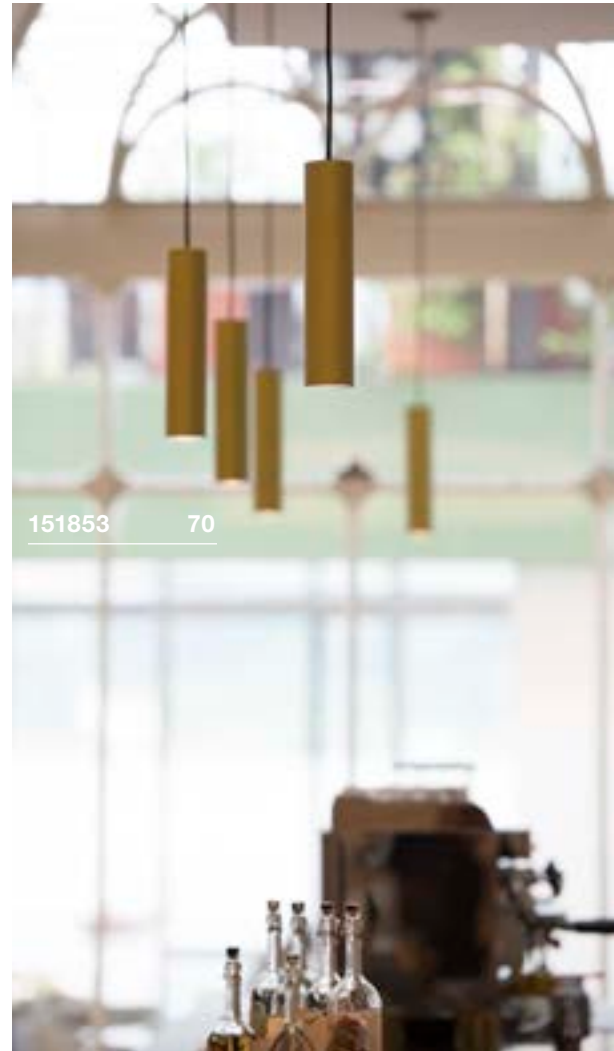

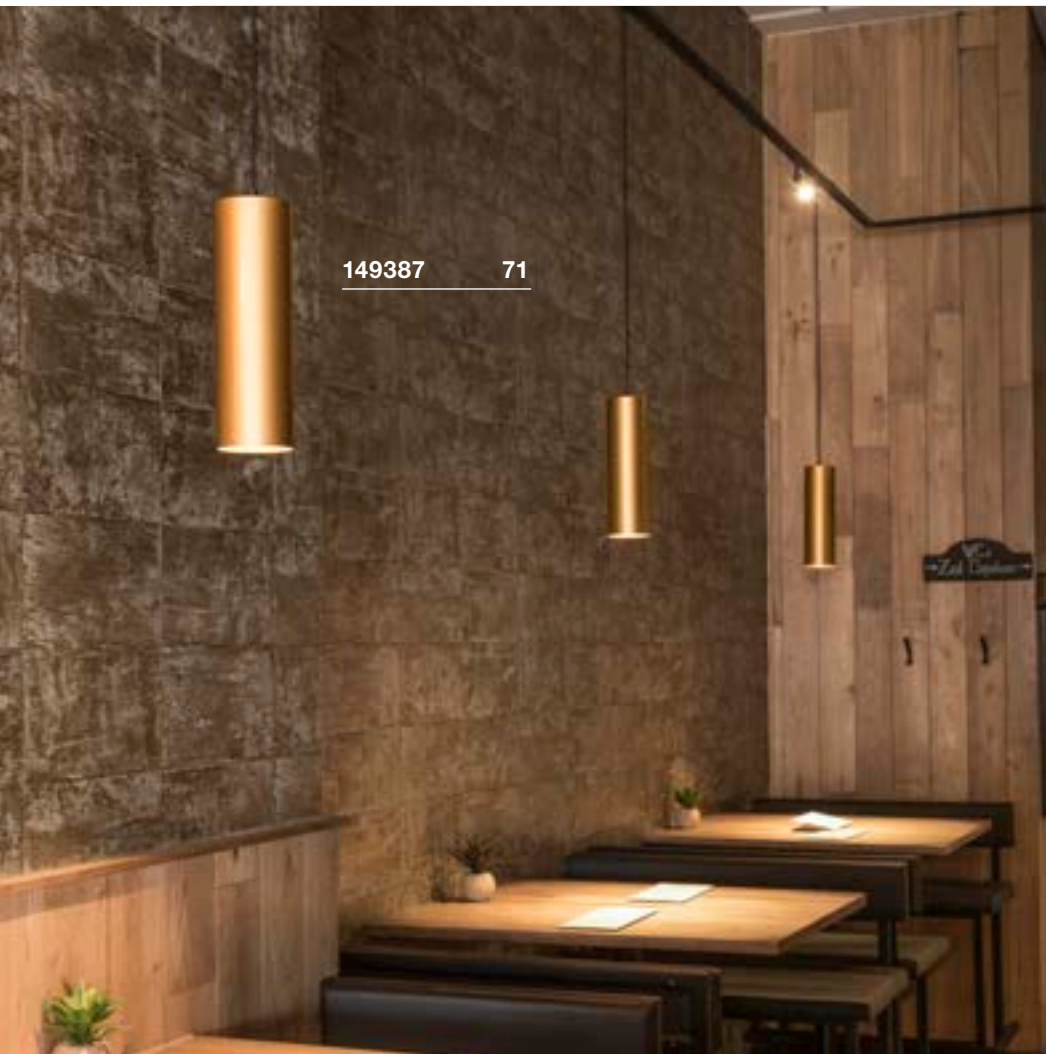

ENOLA PD, E27

885

E-A++ Range
A++-E

Product details

220-240V ~50/60Hz
Material: Aluminium / Steel



0.98

150

Dimensioned drawing

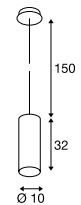

Recommended lamp

LED E27 9,1W 240°
2700K 760lm EEK=A+
10kWh/1000h
Item no. 560402



LED E27 7W 280°
2700K 790lm EEL=A++
7kWh/1000h
Item no. 1002124



Lamp details

max. 60W
Ø: 9 cm max. L: 18 cm max.

Variant	Item no.
E27	
■ matt black	149388
E27	
□ white	149381
E27	
■ matt aluminium	149385
E27	
■ gold	149387

HELIA 30 PD



A-A++ Range A++-E

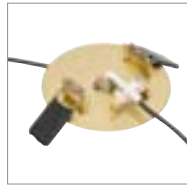

- Premium LED with CRI>90
- Slim, extra-long lamp body
- Canopy for ceiling installation

Product details

500mA
 Total consumption: 7.5W
 Material: Aluminium
 Installation dimensions:
 Installation Ø: 6.8 cm D: 3 cm

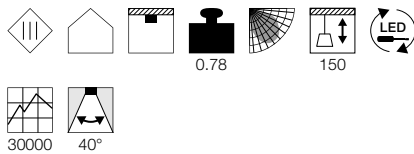

Dimensioned drawing

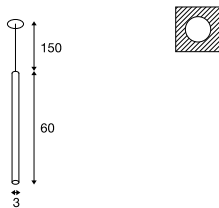

Note

LED driver excl.
 Material thickness, mounting surface:
 max. 12 mm

Recommended accessories

- LED driver 500mA | 9W
Item no. 464091
- LED driver 500mA | 15W dimmable
Item no. 464144

Variant	Item no.
500lm 3000K CRI>90	
■ black	158400
550lm 3000K CRI>90	
□ white	158401
550lm 3000K CRI>90	
■ gold	1002170

HELIA 40 PD



A-A++ Range A++-E

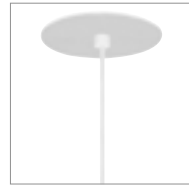

- Premium LED with CRI>90
- Long lamp body
- Canopy for ceiling installation

Product details

500mA
 Total consumption: 9W
 Material: Aluminium
 Installation dimensions:
 Installation Ø: 6.8 cm D: 3 cm

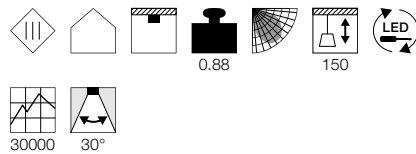

Dimensioned drawing

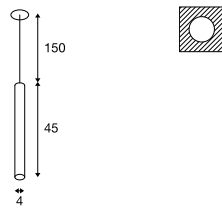

Note

LED driver excl.
 Material thickness, mounting surface:
 max. 12 mm

Recommended accessories

- LED driver 500mA | 9W
Item no. 464091
- LED driver 500mA | 15W dimmable
Item no. 464144

Variant	Item no.
700lm 3000K CRI>90	
■ black	158410
720lm 3000K CRI>90	
□ white	158411
720lm 3000K CRI>90	
■ gold	1002169

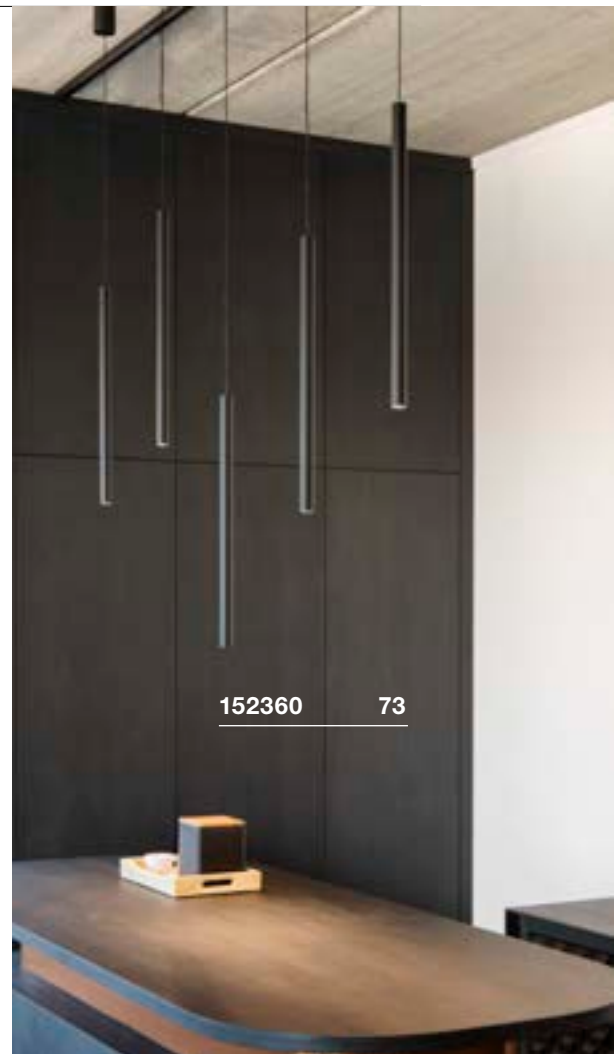



HELIA 40

Ø: 4 cm | L: 45 cm

HELIA 30

Ø: 3 cm | L: 60 cm

HELIA 30
PD, TRIAC



A-A++ Range A++-E



- Premium LED with CRI>90

Product details

220-240V ~50/60Hz | 500mA
Total consumption: 10W
Material: Aluminium
Dimmable: Triac C, Triac L

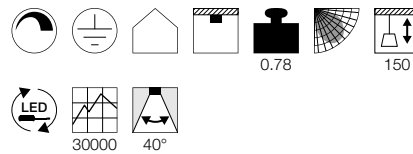

Dimensioned drawing

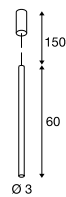

HELIA 40
PD, TRIAC



A-A++ Range A++-E



- Premium LED with CRI>90

Product details

220-240V ~50/60Hz | 500mA
Total consumption: 12W
Material: Aluminium
Dimmable: Triac C, Triac L

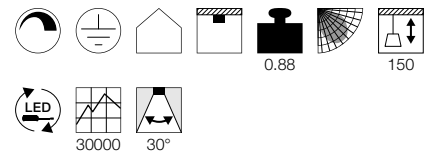

Dimensioned drawing

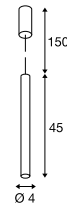

Variant	Item no.
500lm 3000K CRI>90	
■ black	152360
550lm 3000K CRI>90	
□ white	152361
550lm 3000K CRI>90	
■ gold	1002172

Variant	Item no.
700lm 3000K CRI>90	
■ black	152370
720lm 3000K CRI>90	
□ white	152371
720lm 3000K CRI>90	
■ gold	1002171

ANELA
PD, TRIAC



883

A-A++ Range
A++-E



- Premium LED with CRI>90
- Glare-reducing
- Coloured reflectors available as accessories

Product details

220-240V ~50/60Hz | 500mA
Total consumption: 11W
Material: Aluminium
Dimmable: Triac C

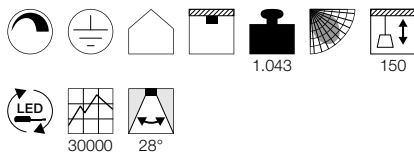

Dimensioned drawing

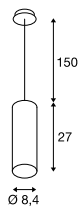

Note

Reflec or excl.
Lumen output with reflec or 1000809 = 500lm
Lumen output with reflec or 1000810 = 620lm
Lumen output with reflec or 1000811 = 200lm
Lumen output with reflec or 1000812 = 600lm

Recommended accessories

- Reflec or 28°
Item no. 1000809
- Reflec or 28°
Item no. 1000810
- Reflec or 28°
Item no. 1000811
- Reflec or 28°
Item no. 1000812

Variant	Item no.
200-620lm 3000K CRI>90	
■ black	1000813
200-620lm 3000K CRI>90	
□ white	1000814

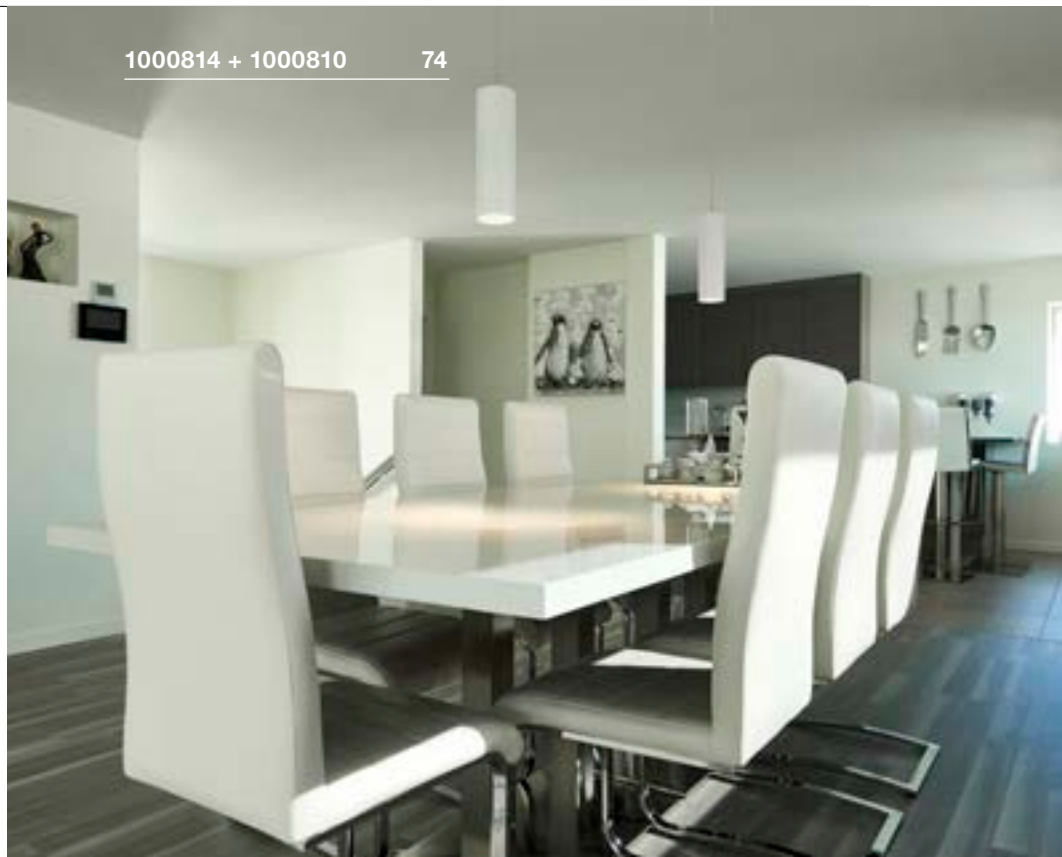

1000814 + 1000810 74



1000813 + 1000810 74

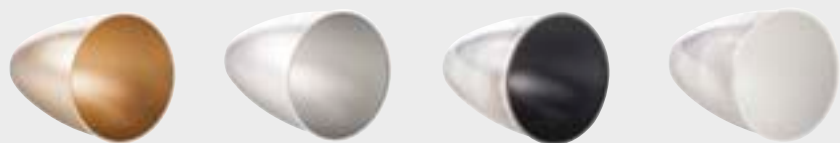

Reflec or 28° – the reflec or of this luminaire can be replaced, giving you a completely new lighting effect due o the diffe ent colours (gold, grey, black and white).



134011

75

134001

75

LIGHT PIPE 60/90
PD, TRIAC

890

A-A++ Range A++-E

LED INSIDE



- Height adjustable

Product details

220-240V ~50/60Hz
Total consumption: 11W
Material: Aluminium / Polymethylacrylate (PMMA)
Dimmable: Triac C, Triac L

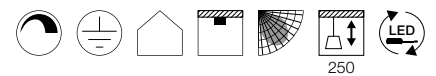

Dimensioned drawing

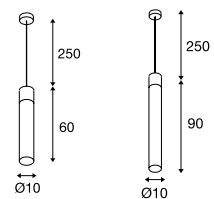

Variant	Item no.
630lm 2700K CRI>80 H: 60 cm 1.88 kg	
□ white	134001
630lm 2700K CRI>80 H: 90 cm 2.1 kg	
□ white	134011

LISENNE
PD, E27

890

E-A++ Range
A++-E

- Basalt and smoked glass
- Height adjustable

Product details

220-240V ~50/60Hz
Material: Basalt / Glass

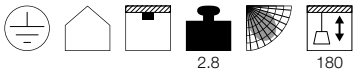

2.8

180

Dimensioned drawing

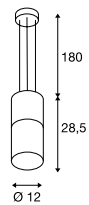

Recommended lamp

LED E27 7.1W 330°
2700K 806lm EEL=A+
8kWh/1000h

Item no. 1001756



Lamp details

max. 23W
Ø: 5.9 cm max. L: 15 cm max.

Variant	Item no.
E27	
■ grey / brown	155714



COMMO
PD, TCR-TSE

B-A++ Range A++-E



Product details

230V ~50Hz
Material: Steel / Glass

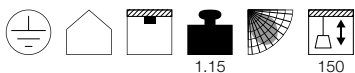

Dimensioned drawing

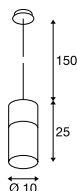

Recommended lamp

GX53 7.5W 120°
3000K 620lm EEL=A+
8kWh/1000h
Item no. 1001220



LED GX53 7.5W 25°
3000K 450lm EEL=A
8kWh/1000h
Item no. 550082



Lamp details

max. 13W TCR-TSE

Variant	Item no.
GX53 TCR-TSE	
■ chrome	149380

TONGA®
PD, E14



E-A++ Range A++-E



Product details

220-240V ~50/60Hz
Material: Aluminium / Glass

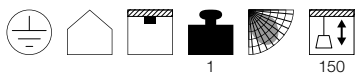

Dimensioned drawing

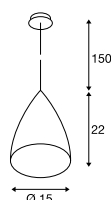

Recommended lamp

E14 3.4W 260°
3000K 250lm EEL=A+
4kWh/1000h
Item no. 560362



LED E14 6.5W 280°
3000K 480lm EEL=A+
7kWh/1000h
Item no. 560372



Lamp details

max. 60W C35
Ø: 5 cm max. L: 13 cm max.

Variant	Item no.
E14 C35	
■ grey / shiny opaque	133444

BIBA
PD, E14

E-A++ Range A++-E

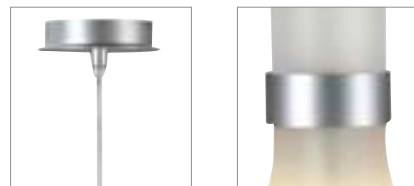

Product details

230V ~50Hz
Material: Aluminium / Glass

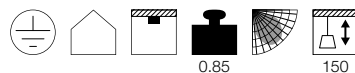

Dimensioned drawing

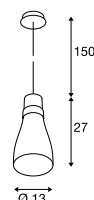

Recommended lamp

LED E14 6.5W 280°
3000K 480lm EEL=A+
7kWh/1000h
Item no. 560372



Lamp details

max. 60W C35
Ø: 5 cm max. L: 13 cm max.

Variant	Item no.
E14 C35	
■ aluminium / white	133464

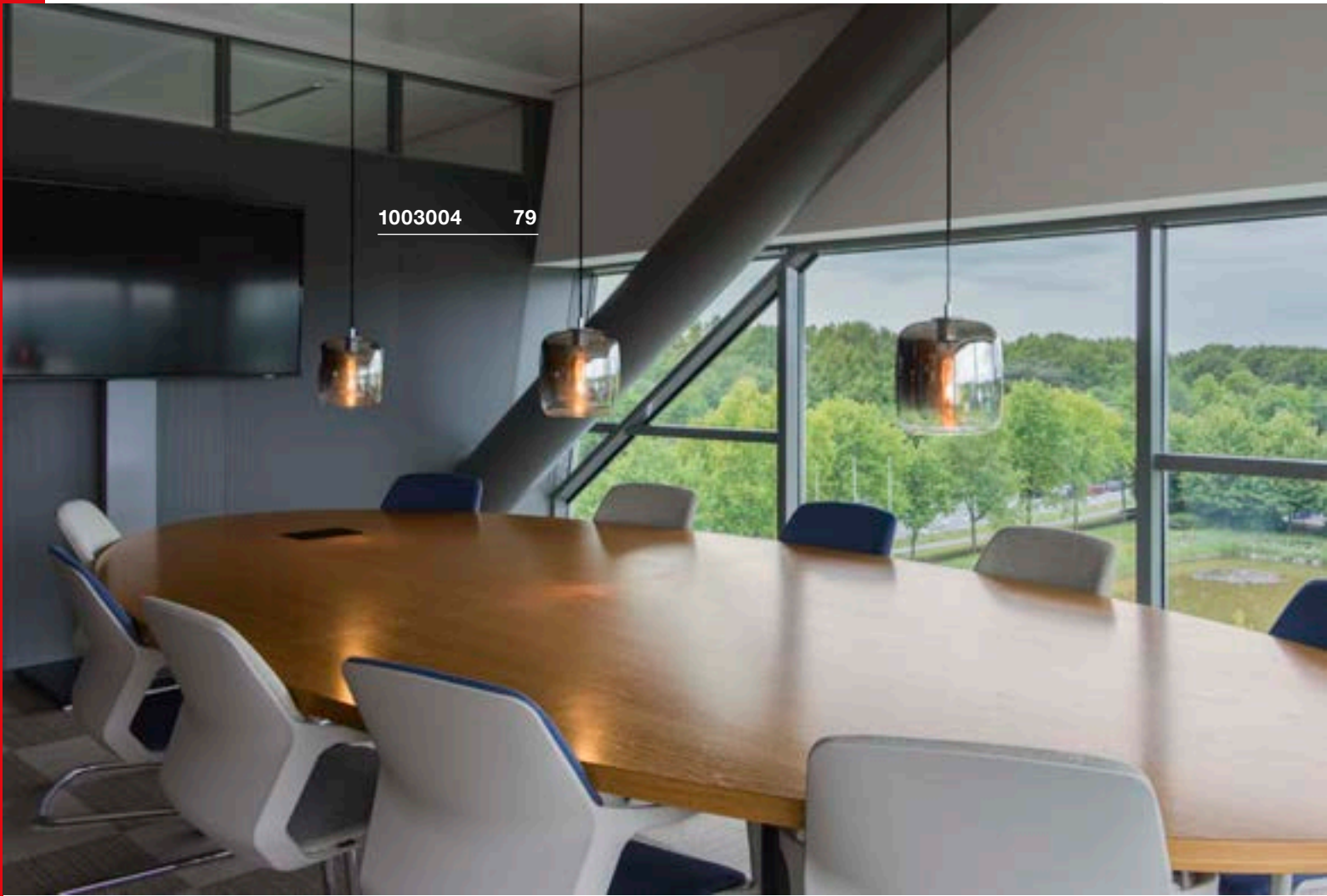

1003004 79

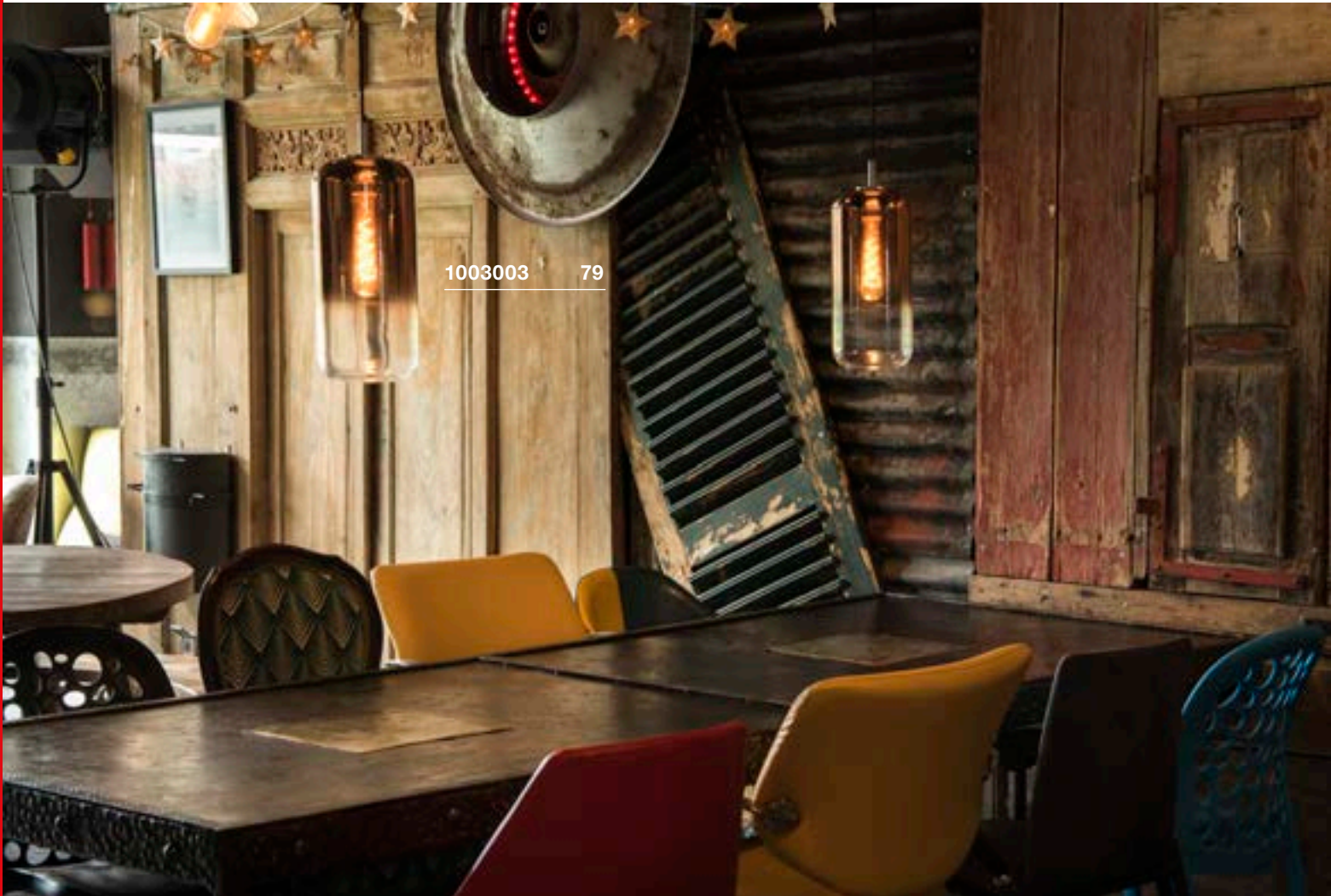

1003003 79

PANTILO 20
PD, E27



- Chrome plated, high-quality glass shade
- Can be combined into a "lighting group" by means of individual configuration

Product details

200-240V ~50/60Hz
Material: Glass
Product dimensions: Ø: 20 cm H: 21.3 cm

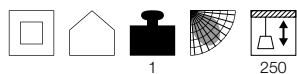

Note

Can be combined with the Fitu Mix & Match accessory on page 40

PANTILO 28
PD, E27



- Chrome plated, high-quality glass shade
- Can be combined into a "lighting group" by means of individual configuration

Product details

200-240V ~50/60Hz
Material: Glass
Product dimensions: Ø: 28 cm H: 17.2 cm



Note

Can be combined with the Fitu Mix & Match accessory on page 40

PANTILO 16
PD, E27



- Chrome plated, high-quality glass shade
- Can be combined into a "lighting group" by means of individual configuration

Product details

200-240V ~50/60Hz
Material: Glass
Product dimensions: Ø: 16 cm H: 35 cm



Note

Can be combined with the Fitu Mix & Match accessory on page 40

Lamp details

max. 15W

Variant	Item no.
E27	
chrome	1003004
E27	
copper	1003005

Lamp details

max. 15W

Variant	Item no.
E27	
chrome	1003006
E27	
copper	1003007

Lamp details

max. 15W

Variant	Item no.
E27	
chrome	1003002
E27	
copper	1003003

SUN / BIG SUN
PD, E27



Product details

230V ~50Hz
Material: Steel / Glass

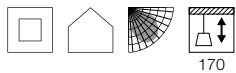

Dimensioned drawing

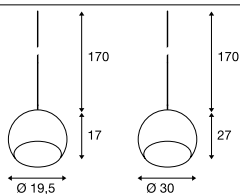

Note

Open cable end
Can be combined with the Fitu Mix & Match accessory on page 40

Recommended lamp

LED E27 14.5W 200°
2700K 1521lm EEL=A+
15kWh/1000h
Item no. 560422



LED E27 7W 280°
2700K 790lm EEL=A++
7kWh/1000h
Item no. 1002124



Lamp details

max. 60W
Ø: 7 cm max. L: 17 cm max.

Variant	Item no.
E27 Ø: 19.5 cm 0.73 kg white / chrome	1002045
E27 Ø: 30 cm 1.83 kg white / chrome	1002046

BRENDA
PD, TRIAC



Product details

220-240V ~50/60Hz | 500mA
Total consumption: 21W
Material: Aluminium / Glass
Dimmable: Triac C

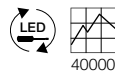
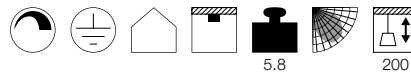

Dimensioned drawing

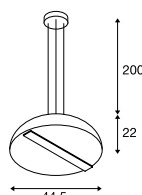

Note

Height adjustable

Variant	Item no.
2000lm 3000K CRI>80 white / matt grey	157701

ROTOBALL 25/40/50
PD, E27



Product details

230V ~50Hz
Material: Steel / Polyethylene (PE)

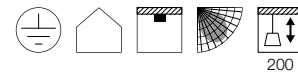

Dimensioned drawing

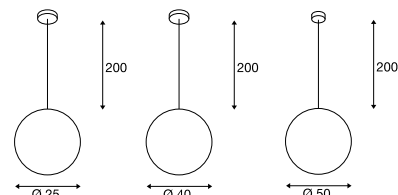

Note

Height adjustable

Recommended lamp

LED E27 14.5W 200°
2700K 1521lm EEL=A+
15kWh/1000h
Item no. 560422



LED E27 9.5W 240°
2200-6700K 806lm EEL=A+
10kWh/1000h
Item no. 1001917



Lamp details

max. 24W
Ø: Item no. 165390 7 cm max.
Ø: Item no. 165410 9.5 cm max.
Ø: Item no. 165400 9.5 cm max.

Variant	Item no.
E27 Ø: 25 cm 1.25 kg white / grey	165390
E27 Ø: 40 cm 2.4 kg white / grey	165410
E27 Ø: 50 cm 3.6 kg white / grey	165400

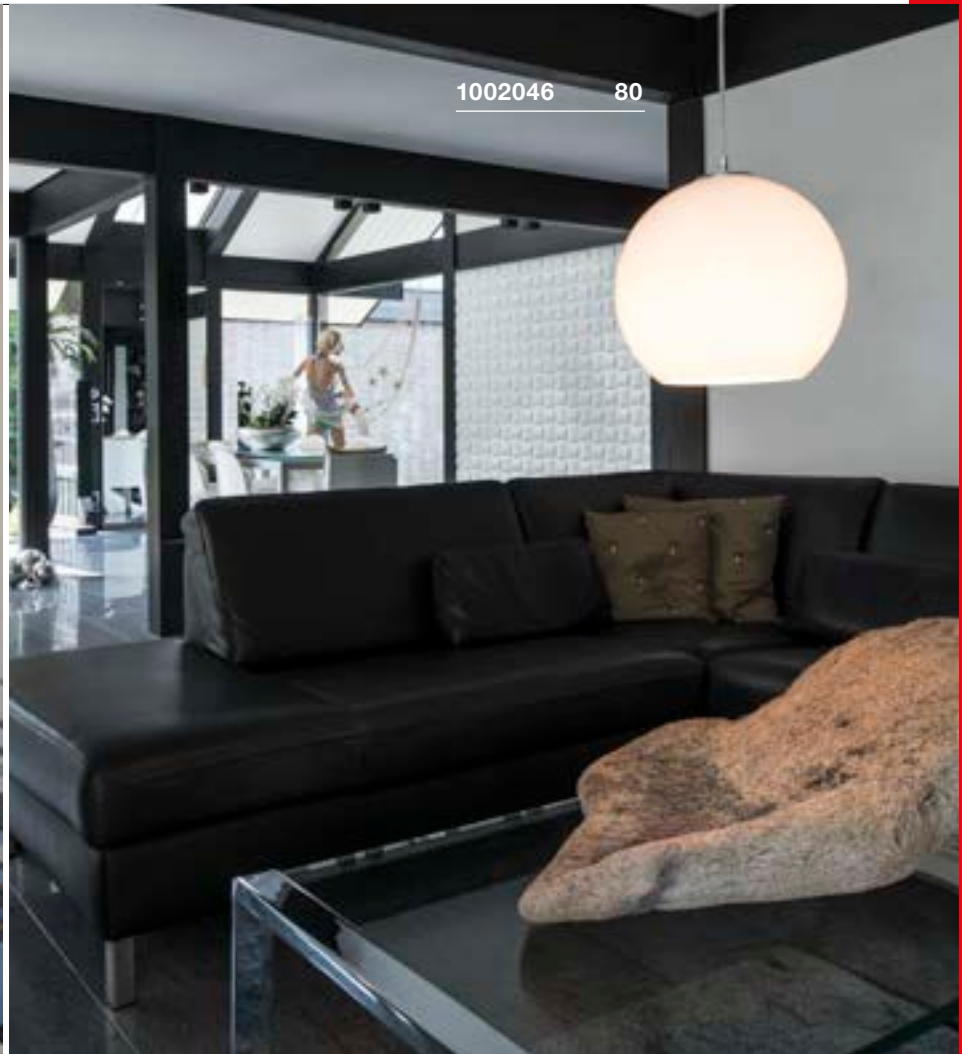

SOPRANA
PD, E27



E-A++ Range A++-E



- Height adjustable
- Acrylic cover on underside of shade

Product details

230V ~50Hz
Material: Textile / Acrylic

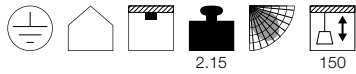

Dimensioned drawing

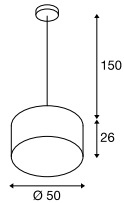

Recommended lamp

LED E27 9,1W 240°
2700K 760lm EEK=A+
10kWh/1000h
Item no. 560402



LED E27 5W 330°
2000K 500lm EEL=A+
5kWh/1000h
Item no. 560741



Lamp details

3x max. 60W
L: 16.5 cm max.

Variant	Item no.
E27	
white	155462
E27	
beige	155463

BISHADE
PD, E27



A-A++ Range A++-E



- Double conical lamp shade
- Height adjustable

Product details

230V ~50Hz
Material: Textile / Steel

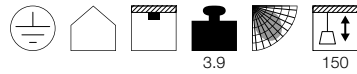

Dimensioned drawing

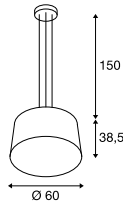

Recommended lamp

LED E27 9,1W 240°
2700K 760lm EEK=A+
10kWh/1000h
Item no. 560402



LED E27 7W 280°
2200-2700K 830lm EEI=A++
7kWh/1000h
Item no. 1002126



Lamp details

3x max. 23W
L: 17 cm max.

Variant	Item no.
E27	
black / transparent	155650



155462 82



155650 82



1002947 83



155871 83

ACCANTO
PD, E27



E-A++ Range A++-E

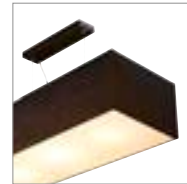

- Acrylic cover on underside of shade
- Height adjustable

Product details

220-240V ~50/60Hz
Material: Steel / Textile
Product dimensions:
L: 80 cm W: 30 cm H: 20 cm

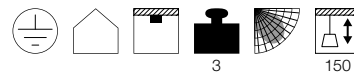

TRIADEM
PD, E27

E-A++ Range A++-E

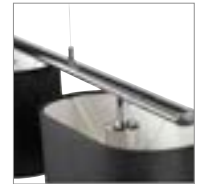

- Height adjustable

Product details

230V ~50Hz
Material: Textile / Steel

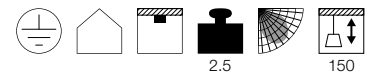

Dimensioned drawing

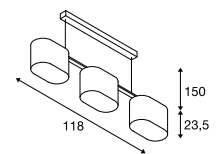

Recommended lamp

LED E27 14.5W 200°
2700K 1521lm EEI=A+
15kWh/1000h
Item no. 560422



LED E27 9W 240°
2700-6500K 806lm EEI=A+
9kWh/1000h
Item no. 1001916



Lamp details

3x max. 40W
L: 13 cm max.

Variant	Item no.
E27	
■ black / chrome	1002946
E27	
■ white / chrome	1002947

Recommended lamp

LED E27 14.5W 200°
2700K 1521lm EEI=A+
15kWh/1000h
Item no. 560422



LED E27 9W 240°
2700-6500K 806lm EEI=A+
9kWh/1000h
Item no. 1001916



Lamp details

3x max. 60W
L: 14 cm max.

Variant	Item no.
E27	
■ black / chrome	155870
E27	
■ white / chrome	155871

LASSON 10
PD, E27



E-A++ Range A++-E



Product details

230V ~50Hz
Material: Steel / Textile

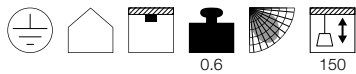

Dimensioned drawing

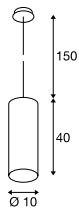

Recommended lamp

LED E27 9.1W 240°
2700K 760lm EEL=A+
10kWh/1000h
Item no. 560402



LED E27 4.5W 280°
2200-2700K 500lm EEL=A++
5kWh/1000h
Item no. 1002125



Lamp details

max. 40W

Variant	Item no.
E27	
■ black	155380

LASSON 45
PD, E27



E-A++ Range A++-E

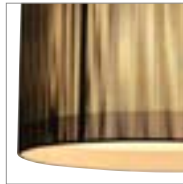
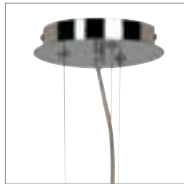

- Acrylic glass cover on underside of shade
- Height adjustable

Product details

230V ~50Hz
Material: Textile / Acrylic

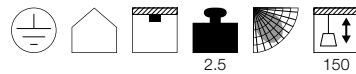

Dimensioned drawing

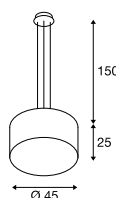

Recommended lamp

LED E27 9.1W 240°
2700K 760lm EEK=A+
10kWh/1000h
Item no. 560402



LED E27 7W 280°
2200-2700K 830lm EEL=A++
7kWh/1000h
Item no. 1002126



Lamp details

3x max. 60W
L: 13 cm max.

Variant	Item no.
E27	
■ black	155300



155380 84



155300 84



155290 85

LASSON 80
PD, E27

889

E-A++ Range
A++-E

- Glass cover on bottom of shade
- Height adjustable

Product details230V ~50Hz
Material: Textile / Glass

4.4

150

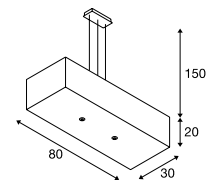





Dimensioned drawing**Recommended lamp**LED E27 14.5W 200°
2700K 1521lm EEL=A+
15kWh/1000h
Item no. 560422LED E27 9W 240°
2700-6500K 806lm EEL=A+
9kWh/1000h
Item no. 1001916**Lamp details**4x max. 60W
Ø: 8 cm max. L: 18 cm max.

Variant	Item no.
E27 ■ black	155290

MEDO LIGHT SERIES.

PENDANT OR CEILING LIGHT

	MEDO 30 CL, 1-10V	MEDO 40 CL, 1-10V	MEDO 60 CL, 1-10V	MEDO 90 CL, 1-10V
Example				
Lamp				
Size	Ø: 30 cm	Ø: 40 cm	Ø: 60 cm	Ø: 90 cm
Luminous intensity	1000lm	2000lm	3500lm	11000lm
UGR	25	25	22	25
Dimmable	1-10V	1-10V	1-10V	1-10V
Suspension set (excl.)	1.5 m 5 m	1.5 m 5 m	1.5 m 5 m	1.5 m 5 m

	MEDO 30 CL, TRIAC	MEDO 40 CL, TRIAC	
Example			
Lamp			
Size Ø	Ø: 30 cm	Ø: 40 cm	
Luminous intensity	1200lm	2125lm	
UGR	25	25	
Dimmable	Triac C, Triac L	Triac C, Triac L	
Suspension set (excl.)	1.5 m 5 m	1.5 m 5 m	 <p>This MEDO variant is dimmed using TRIAC dimmers!</p>



	MEDO 60 CL, square, 1-10V	MEDO 60 CL, square, DALI	
Example			
Lamp			
Size	W L: 60 cm	W L: 60 cm	
Luminous intensity	3300 lm	3300 lm	
UGR	22	22	
Dimmable	1-10V	Dali	
Suspension set (excl.)	1.5 m 5 m	1.5 m 5 m	

	MEDO RING 60 PD, 1-10V	MEDO RING 90 PD, 1-10V	MEDO RING 60 PD, DALI
Example			
Lamp			
Size	Ø: 60 cm	Ø: 90 cm	Ø: 60 cm
Luminous intensity	2000lm	3945lm	2000lm
UGR	-	-	22
Dimmable	1-10V	1-10V	Dali
Suspension set	Not required, (incl.) – Pendant only	Not required, (incl.) – Pendant only	Not required, (incl.) – Pendant only

MEDO LIGHT SERIES.

PENDANT OR CEILING LIGHT

	MEDO 30 CORONA CW, TRIAC	MEDO 40 CORONA CW, TRIAC	MEDO 60 CORONA CW, TRIAC	MEDO 90 CORONA CW, TRIAC
Example				
Lamp				
Size	Ø: 30 cm	Ø: 40 cm	Ø: 60 cm	Ø: 90 cm
Luminous intensity	Down: 1230/1280lm Up: 20lm	Down: 2750/2900lm Up: 50lm	Down: 4350/4750lm Up: 120lm	Down: 9500/10100lm Up: 125lm
UGR	25	25	25	25
Dimmable	Triac C	Triac C	Triac C	Triac C
Suspension set (excl.)	1.5 m 5 m	1.5 m 5 m	1.5 m 5 m	1.5 m 5 m

	MEDO 30 CORONA CW, DALI	MEDO 40 CORONA CW, DALI	MEDO 60 CORONA CW, DALI	MEDO 90 CORONA CW, DALI
Example				
Lamp				
Size	Ø: 30 cm	Ø: 40 cm	Ø: 60 cm	Ø: 90 cm
Luminous intensity	Down: 1230/1280lm Up: 20lm	Down: 2750/2900lm Up: 50lm	Down: 4350/4750lm Up: 120lm	Down: 9500/10100lm Up: 125lm
UGR	25	25	25	25
Dimmable	DALI	DALI	DALI	DALI
Suspension set (excl.)	1.5 m 5 m	1.5 m 5 m	1.5 m 5 m	1.5 m 5 m

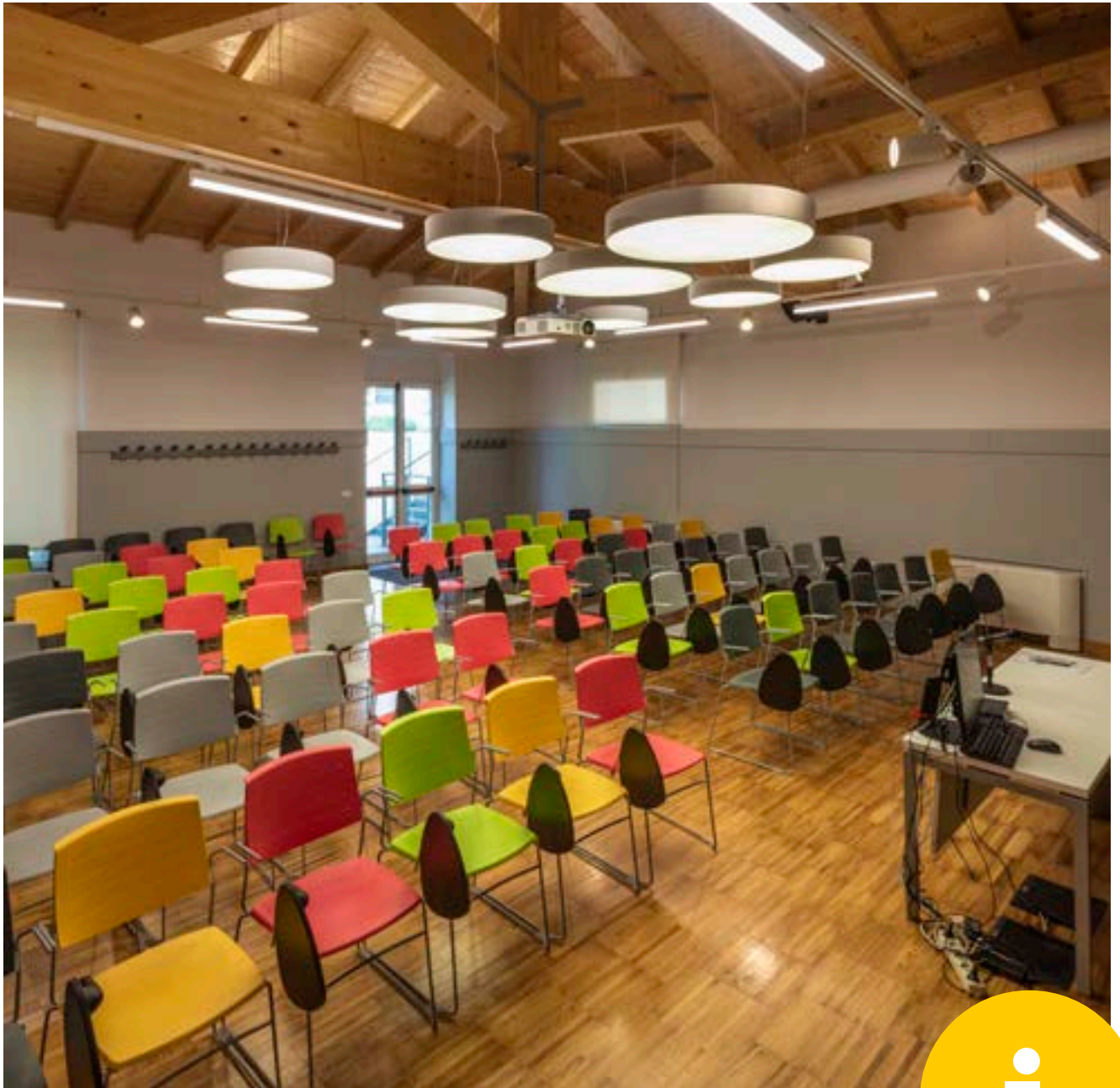

Corona effect these MEDO variants have homogeneous indirect upwards-directed light emission.

Colour temperature – with this MEDO variant you can select the colour temperature yourself. You can choose between 3000K and 4000K using the switch on the back.

MEDO 30
CL, TRIAC



A-A++ Range A++-E



LED INSIDE



- Can be converted into a pendant using the additionally available accessories

Product details

220-240V ~50/60Hz | 350mA
Total consumption: 16W
Material: Aluminium / Polymethylacrylate (PMMA)
Dimmable: Triac C, Triac L

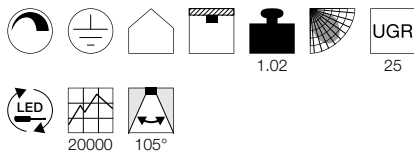

Dimensioned drawing

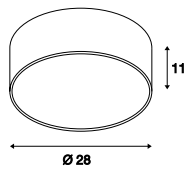

Note

Suspension set excl.

Recommended accessories

- Suspension set 1.5m
Item no. **135250**
- Suspension set 1.5m
Item no. **135251**
- Suspension set 1.5m
Item no. **135254**
- Suspension set 5m
Item no. **1001950**
- Suspension set 5m
Item no. **1001951**
- Suspension set 5m
Item no. **1001952**

Variant	Item no.
1200lm 3000K CRI>80 ■ black	135020
1200lm 3000K CRI>80 □ white	135021
1200lm 3000K CRI>80 ■ grey	135024
1200lm 3000K CRI>80 ■ red	135026



135250 90

135120 92

135020 90

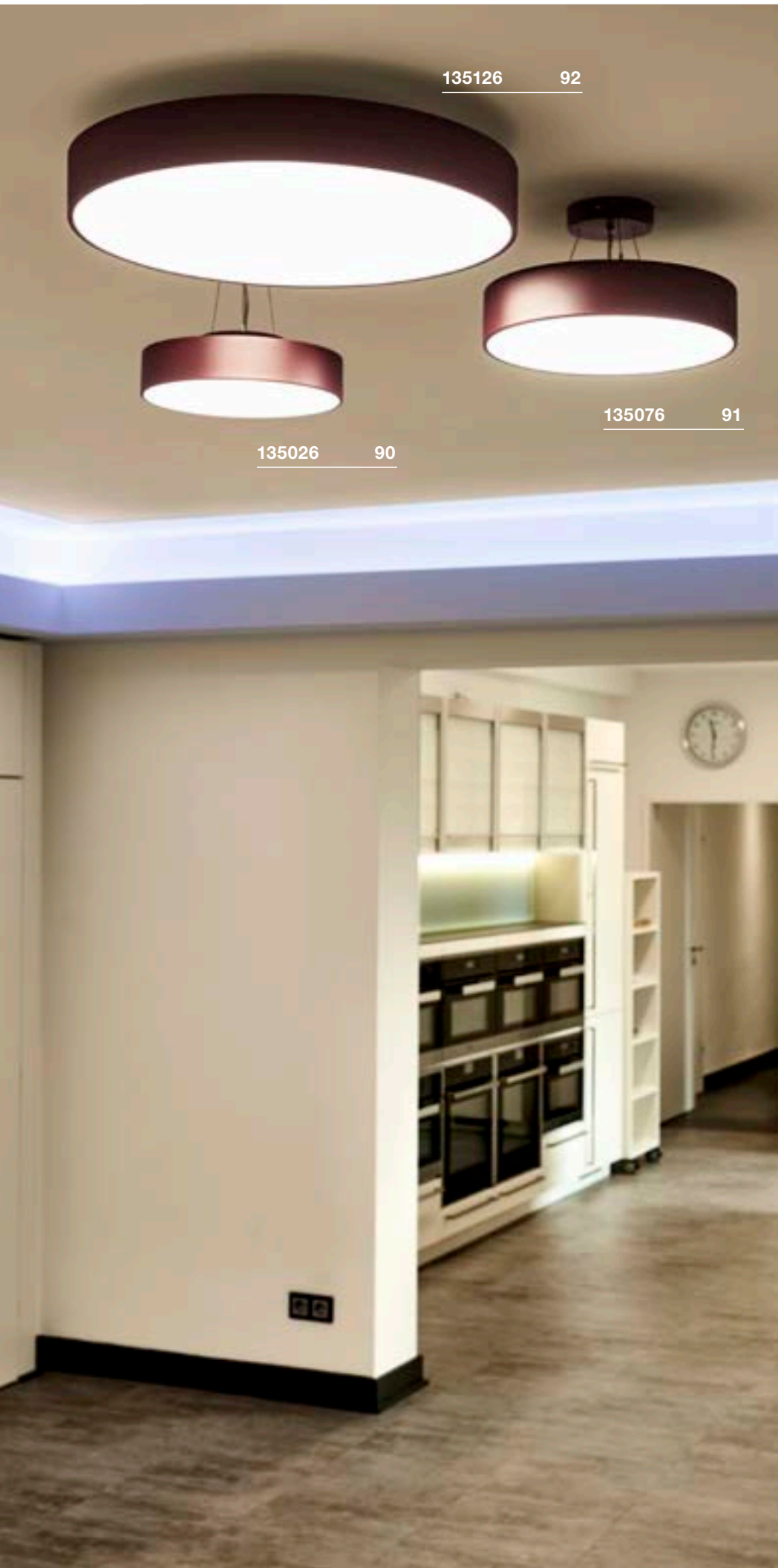

135126 92

135026 90

135076 91

MEDO 40
CL, TRIAC



A-A++ Range A++-E



LED INSIDE



- Can be converted into a pendant using the additionally available accessories

Product details

220-240V ~50/60Hz | 700mA
Total consumption: 31W
Material: Aluminium / Polymethylacrylate (PMMA)
Dimmable: Triac C, Triac L

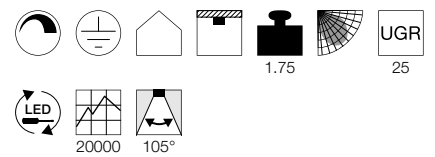

Dimensioned drawing

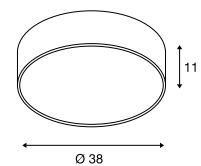

Note

Suspension set excl.

Recommended accessories

- Suspension set 1.5m
Item no. 135250
- Suspension set 1.5m
Item no. 135251
- Suspension set 1.5m
Item no. 135254
- Suspension set 5m
Item no. 1001950
- Suspension set 5m
Item no. 1001951
- Suspension set 5m
Item no. 1001952

Variant	Item no.
2125lm 3000K CRI>80 ■ black	135070
2125lm 3000K CRI>80 □ white	135071
2125lm 3000K CRI>80 ■ grey	135074
2125lm 3000K CRI>80 ■ red	135076

MEDO 30
CL, 1-10V



A-A++ Range A++-E



- Can be converted into a pendant using the additionally available accessories

Product details

220-240V ~50/60Hz | 350mA
Total consumption: 15W
Material: Aluminium / Polymethylacrylate (PMMA)
Dimmable: 1-10V

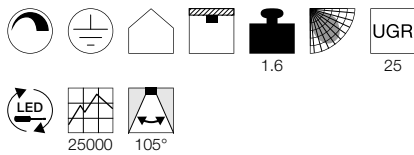

Dimensioned drawing

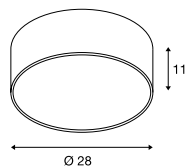

Note

Suspension set excl.

Recommended accessories

- Suspension set 1.5m
Item no. 135250
- Suspension set 1.5m
Item no. 135251
- Suspension set 1.5m
Item no. 135254
- Suspension set 5m
Item no. 1001950
- Suspension set 5m
Item no. 1001951
- Suspension set 5m
Item no. 1001952

Variant	Item no.
1000lm 3000K CRI>80 ■ black	1000855
1000lm 3000K CRI>80 □ white	1000856
1000lm 3000K CRI>80 ■ grey	1000857

MEDO 40
CL, 1-10V



A-A++ Range A++-E

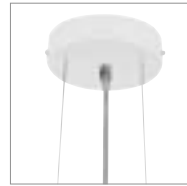

- Can be converted into a pendant using the additionally available accessories

Product details

120-240V ~50/60Hz | 700mA
Total consumption: 29W
Material: Aluminium / Polymethylacrylate (PMMA)
Dimmable: 1-10V

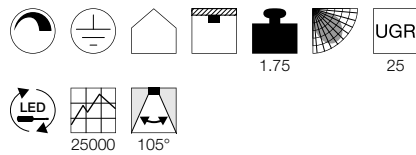

Dimensioned drawing

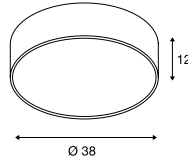

Note

Suspension set excl.

Recommended accessories

- Suspension set 1.5m
Item no. 135250
- Suspension set 1.5m
Item no. 135251
- Suspension set 1.5m
Item no. 135254
- Suspension set 5m
Item no. 1001950
- Suspension set 5m
Item no. 1001951
- Suspension set 5m
Item no. 1001952

Variant	Item no.
2000lm 3000K CRI>80 ■ black	1000864
2000lm 3000K CRI>80 □ white	1000865
2000lm 3000K CRI>80 ■ grey	1000866

MEDO 60
CL, 1-10V



A-A++ Range A++-E



- Can be converted into a pendant using the additionally available accessories

Product details

100-240V ~50/60Hz | 1000mA
Total consumption: 40W
Material: Aluminium / Polymethylacrylate (PMMA)
Dimmable: 1-10V

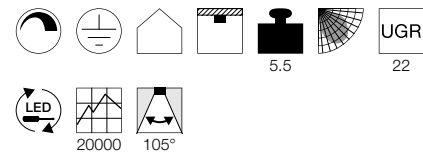

Dimensioned drawing

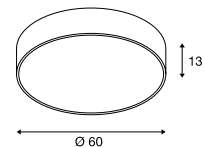

Note

Suspension set excl.

Recommended accessories

- Suspension set 1.5m
Item no. 135250
- Suspension set 1.5m
Item no. 135251
- Suspension set 1.5m
Item no. 135254
- 1-10V dimming
Item no. 470505
- Suspension set 5m
Item no. 1001950
- Suspension set 5m
Item no. 1001951
- Suspension set 5m
Item no. 1001952

Variant	Item no.
3500lm 3000K CRI>80 ■ black	135120
3500lm 3000K CRI>80 □ white	135121
3500lm 3000K CRI>80 ■ grey	135124
3500lm 3000K CRI>80 ■ red	135126

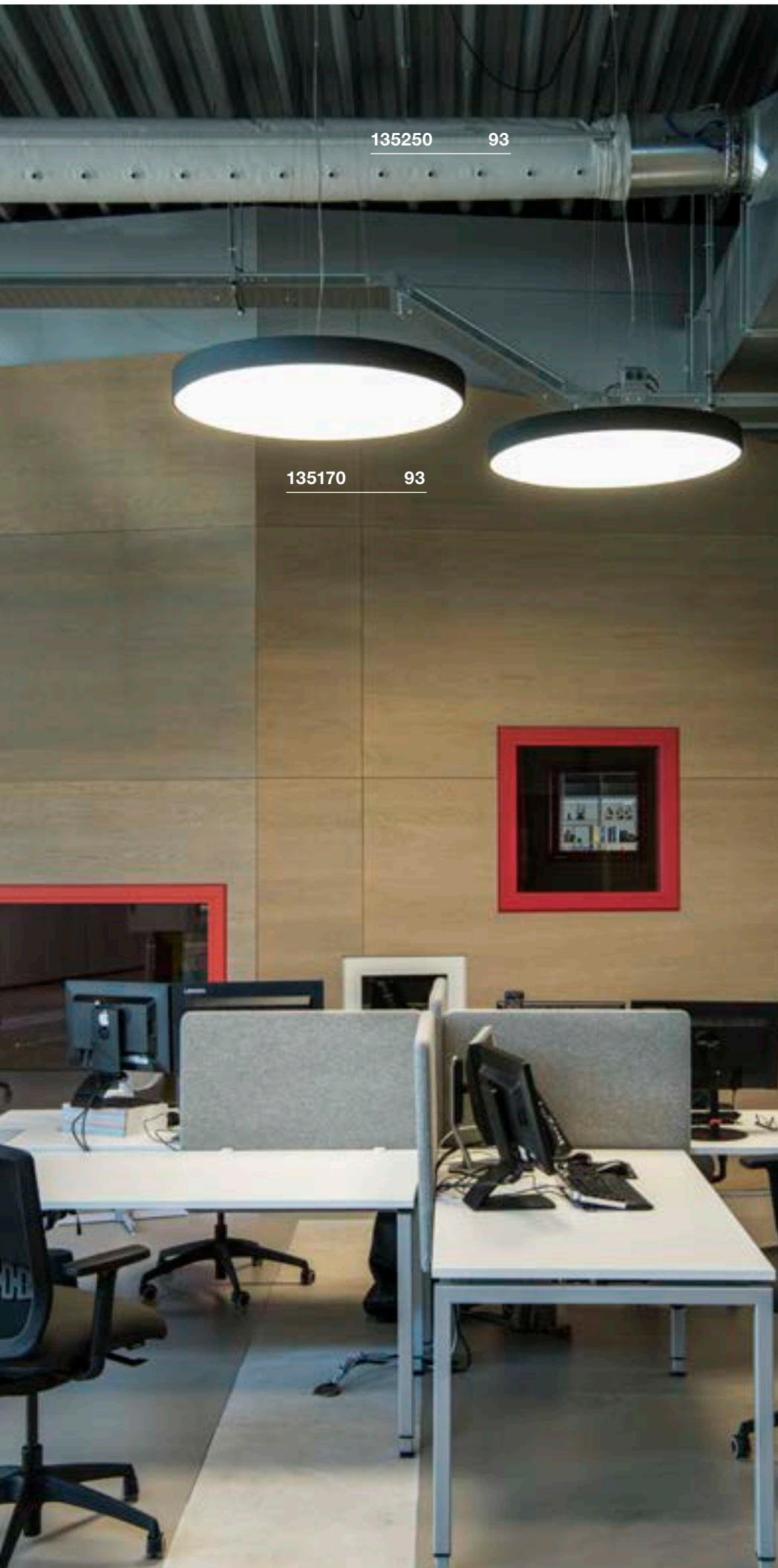

135250 93

135170 93

MEDO 90
CL, 1-10V



A-A++ Range A++-E



LED INSIDE



- Can be converted into a pendant using the additionally available accessories

Product details

220-240V ~50/60Hz | 2900mA
Total consumption: 119W
Material: Aluminium / Polymethylacrylate (PMMA)
Dimmable: 1-10V

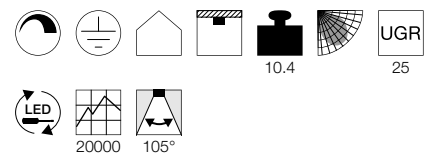

Dimensioned drawing

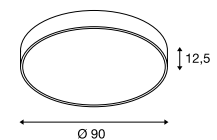

Note

Suspension set excl.

Recommended accessories

- Suspension set 1.5m
Item no. 135250
- Suspension set 1.5m
Item no. 135251
- Suspension set 1.5m
Item no. 135254
- 1-10V dimming
Item no. 470505
- Suspension set 5m
Item no. 1001950
- Suspension set 5m
Item no. 1001951
- Suspension set 5m
Item no. 1001952

Variant	Item no.
11000lm 3000K CRI>80	
■ black	135170
11000lm 3000K CRI>80	
□ white	135171
11000lm 3000K CRI>80	
■ grey	135174
11000lm 3000K CRI>80	
■ red	135176

MEDO 30 CORONA
CW, TRIAC



A-A++ Range
A++-E



- With corona effect
- Colour temperature (3000K/4000K) selectable using a switch
- Can be converted into a pendant using the additionally available accessories

Product details

220-240V ~50/60Hz | 350mA
Total consumption: 15W
Material: Aluminium / Polycarbonate (PC)
Dimmable: Triac C

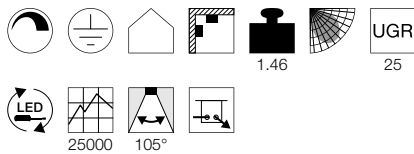

Dimensioned drawing

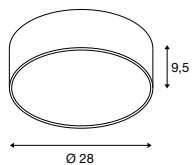

Note

Suspension set excl.

Recommended accessories

- Suspension set 1.5m
Item no. 135250
- Suspension set 1.5m
Item no. 135251
- Suspension set 1.5m
Item no. 135254
- Suspension set 5m
Item no. 1001950
- Suspension set 5m
Item no. 1001951
- Suspension set 5m
Item no. 1001952

Variant	Item no.
Down: 1230/1280lm 3000/4000K CRI>80 Up: 20lm 3000/4000K CRI>80	
■ black	1001877
Down: 1230/1280lm 3000/4000K CRI>80 Up: 20lm 3000/4000K CRI>80	
□ white	1001881
Down: 1230/1280lm 3000/4000K CRI>80 Up: 20lm 3000/4000K CRI>80	
■ grey	1001882

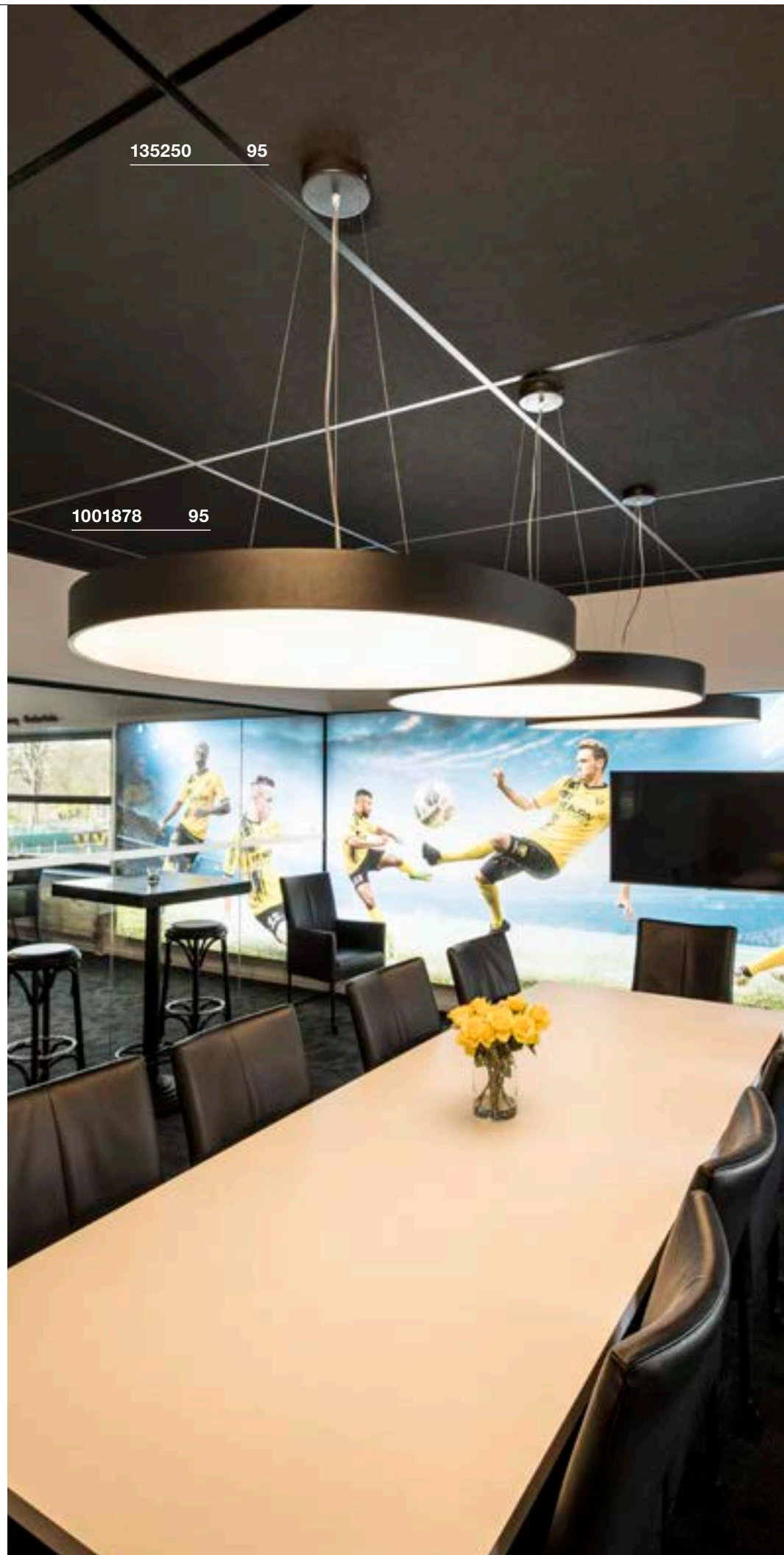

135250 95

1001878 95

MEDO 40 CORONA
CW, TRIAC



A-A++ Range A++-E



- With corona effect
- Colour temperature (3000K/4000K) selectable using a switch
- Can be converted into a pendant using the additionally available accessories

Product details

220-240V ~50/60Hz | 700mA
Total consumption: 30W
Material: Aluminium / Polycarbonate (PC)
Dimmable: Triac C

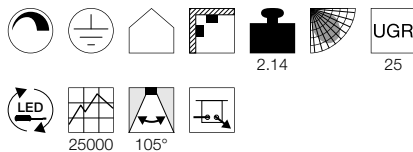

Dimensioned drawing

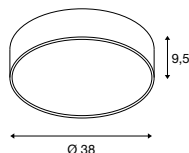

Note

Suspension set excl.

Recommended accessories

- Suspension set 1.5m
Item no. 135250
- Suspension set 1.5m
Item no. 135251
- Suspension set 1.5m
Item no. 135254
- Suspension set 5m
Item no. 1001950
- Suspension set 5m
Item no. 1001951
- Suspension set 5m
Item no. 1001952

Variant	Item no.
Down: 2750/2900lm 3000/4000K CRI>80 Up: 50lm 3000/4000K CRI>80	
■ black	1001883
Down: 2750/2900lm 3000/4000K CRI>80 Up: 50lm 3000/4000K CRI>80	
□ white	1001884
Down: 2750/2900lm 3000/4000K CRI>80 Up: 50lm 3000/4000K CRI>80	
■ grey	1001885

MEDO 60 CORONA
CW, TRIAC



A-A++ Range A++-E



- With corona effect
- Colour temperature (3000K/4000K) selectable using a switch
- Can be converted into a pendant using the additionally available accessories

Product details

220-240V ~50/60Hz | 1050mA
Total consumption: 40W
Material: Aluminium / Polycarbonate (PC)
Dimmable: Triac C

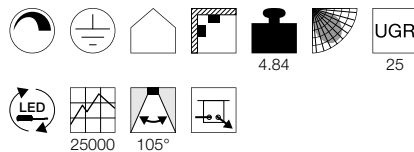

Dimensioned drawing

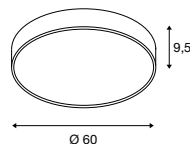

Note

Suspension set excl.

Recommended accessories

- Suspension set 1.5m
Item no. 135250
- Suspension set 1.5m
Item no. 135251
- Suspension set 1.5m
Item no. 135254
- Suspension set 5m
Item no. 1001950
- Suspension set 5m
Item no. 1001951
- Suspension set 5m
Item no. 1001952

Variant	Item no.
Down: 4350/4750lm 3000/4000K CRI>80 Up: 120lm 3000/4000K CRI>80	
■ black	1001886
Down: 4350/4750lm 3000/4000K CRI>80 Up: 120lm 3000/4000K CRI>80	
□ white	1001887
Down: 4350/4750lm 3000/4000K CRI>80 Up: 120lm 3000/4000K CRI>80	
■ grey	1001888

MEDO 90 CORONA
CL, TRIAC



A-A++ Range A++-E



- With corona effect
- Colour temperature (3000K/4000K) selectable using a switch
- Can be converted into a pendant using the additionally available accessories

Product details

220-240V ~50/60Hz | 1050mA
Total consumption: 78W
Material: Aluminium / Polycarbonate (PC)
Dimmable: Triac C

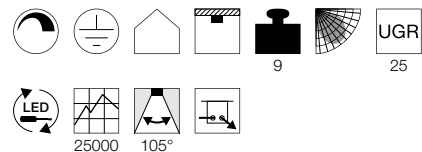

Dimensioned drawing

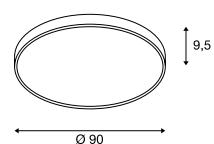

Note

Suspension set excl.

Recommended accessories

- Suspension set 1.5m
Item no. 135250
- Suspension set 1.5m
Item no. 135251
- Suspension set 1.5m
Item no. 135254
- Suspension set 5m
Item no. 1001950
- Suspension set 5m
Item no. 1001951
- Suspension set 5m
Item no. 1001952

Variant	Item no.
Down: 9500/10100lm 3000/4000K CRI>80 Up: 125lm 3000/4000K CRI>80	
■ black	1001878
Down: 9500/10100lm 3000/4000K CRI>80 Up: 125lm 3000/4000K CRI>80	
□ white	1001879
Down: 9500/10100lm 3000/4000K CRI>80 Up: 125lm 3000/4000K CRI>80	
■ grey	1001880

MEDO 30 CORONA
CW, DALI



A-A++ Range A++-E



- With corona effect
- Colour temperature (3000K/4000K) selectable using a switch
- Can be converted into a pendant using the additionally available accessories

Product details

220-240V ~50/60Hz | 350mA
Total consumption: 15W
Material: Aluminium / Polycarbonate (PC)
Dimmable: Dali

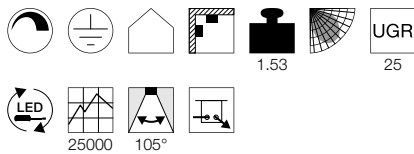

Dimensioned drawing

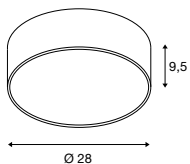

Note

Suspension set excl.

Recommended accessories

- Suspension set 1.5m
Item no. 135250
- Suspension set 1.5m
Item no. 135251
- Suspension set 1.5m
Item no. 135254
- Suspension set 5m
Item no. 1001950
- Suspension set 5m
Item no. 1001951
- Suspension set 5m
Item no. 1001952

Variant	Item no.
Down: 1230/1280lm 3000/4000K CRI>80 Up: 20lm 3000/4000K CRI>80	
■ black	1001889
Down: 1230/1280lm 3000/4000K CRI>80 Up: 20lm 3000/4000K CRI>80	
□ white	1001893
Down: 1230/1280lm 3000/4000K CRI>80 Up: 20lm 3000/4000K CRI>80	
■ grey	1001894

MEDO 40 CORONA
CW, DALI



A-A++ Range A++-E



- With corona effect
- Colour temperature (3000K/4000K) selectable using a switch
- Can be converted into a pendant using the additionally available accessories

Product details

220-240V ~50/60Hz | 700mA
Total consumption: 30W
Material: Aluminium / Polycarbonate (PC)
Dimmable: Dali

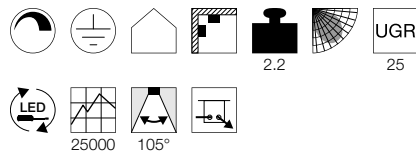

Dimensioned drawing

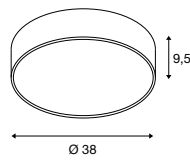

Note

Suspension set excl.

Recommended accessories

- Suspension set 1.5m
Item no. 135250
- Suspension set 1.5m
Item no. 135251
- Suspension set 1.5m
Item no. 135254
- Suspension set 5m
Item no. 1001950
- Suspension set 5m
Item no. 1001951
- Suspension set 5m
Item no. 1001952

Variant	Item no.
Down: 2750/2900lm 3000/4000K CRI>80 Up: 50lm 3000/4000K CRI>80	
■ black	1001895
Down: 2750/2900lm 3000/4000K CRI>80 Up: 50lm 3000/4000K CRI>80	
□ white	1001896
Down: 2750/2900lm 3000/4000K CRI>80 Up: 50lm 3000/4000K CRI>80	
■ grey	1001897

MEDO 60 CORONA
CW, DALI



A-A++ Range A++-E



- With corona effect
- Colour temperature (3000K/4000K) selectable using a switch
- Can be converted into a pendant using the additionally available accessories

Product details

220-240V ~50/60Hz | 1000mA
Total consumption: 40W
Material: Aluminium / Polycarbonate (PC)
Dimmable: Dali

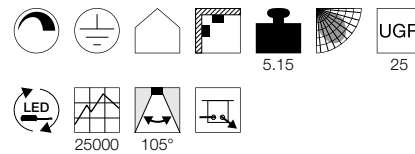

Dimensioned drawing

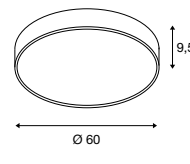

Note

Suspension set excl.

Recommended accessories

- Suspension set 1.5m
Item no. 135250
- Suspension set 1.5m
Item no. 135251
- Suspension set 1.5m
Item no. 135254
- Suspension set 5m
Item no. 1001950
- Suspension set 5m
Item no. 1001951
- Suspension set 5m
Item no. 1001952

Variant	Item no.
Down: 4350/4750lm 3000/4000K CRI>80 Up: 120lm 3000/4000K CRI>80	
■ black	1001898
Down: 4350/4750lm 3000/4000K CRI>80 Up: 120lm 3000/4000K CRI>80	
□ white	1001900
Down: 4350/4750lm 3000/4000K CRI>80 Up: 120lm 3000/4000K CRI>80	
■ grey	1001899



135250 96

1001898 96

MEDO 90 CORONA
CL, DALI
 891

A-A++ Range
A++-E





- With corona effect
- Colour temperature (3000K/4000K) selectable using a switch
- Can be converted into a pendant using the additionally available accessories

Product details

220-240V ~50/60Hz | 1000mA

Total consumption: 78W





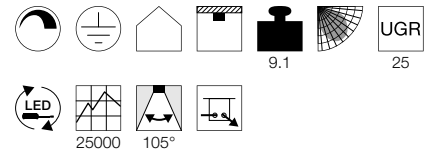
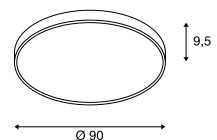

Material: Aluminium / Polycarbonate (PC)



Dimmable: Dali

**Dimensioned drawing****Note**

Suspension set excl.

Recommended accessories

■ Suspension set 1.5m	
Item no. 135250	
□ Suspension set 1.5m	
Item no. 135251	
■ Suspension set 1.5m	
Item no. 135254	
□ Suspension set 5m	
Item no. 1001950	
■ Suspension set 5m	
Item no. 1001951	
■ Suspension set 5m	
Item no. 1001952	

Variant	Item no.
Down: 9500/10100lm 3000/4000K CRI>80 Up: 125lm 3000/4000K CRI>80	
■ black	1001890 
Down: 9500/10100lm 3000/4000K CRI>80 Up: 125lm 3000/4000K CRI>80	
□ white	1001891 
Down: 9500/10100lm 3000/4000K CRI>80 Up: 125lm 3000/4000K CRI>80	
■ grey	1001892 

MEDO 60
CL, square, 1-10V



A-A++ Range
A++-E



LED
INSIDE



- Can be converted into a pendant using the additionally available accessories

Product details

100-240V ~50/60Hz | 1000mA
Total consumption: 39W
Material: Aluminium / Acrylic
Dimmable: 1-10V

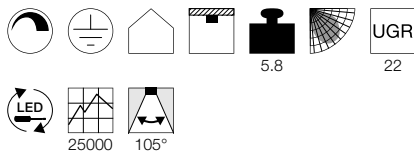

Dimensioned drawing

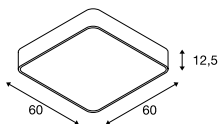

Note

Suspension set excl.

Recommended accessories

- Suspension set 1.5m
Item no. 135250
- Suspension set 1.5m
Item no. 135251
- Suspension set 1.5m
Item no. 135254
- 1-10V dimming
Item no. 470505
- Suspension set 5m
Item no. 1001950
- Suspension set 5m
Item no. 1001951
- Suspension set 5m
Item no. 1001952

Variant	Item no.
3300lm 3000K CRI>80 ■ black	1000725
3300lm 3000K CRI>80 □ white	1000726
3300lm 3000K CRI>80 ■ grey	1000727

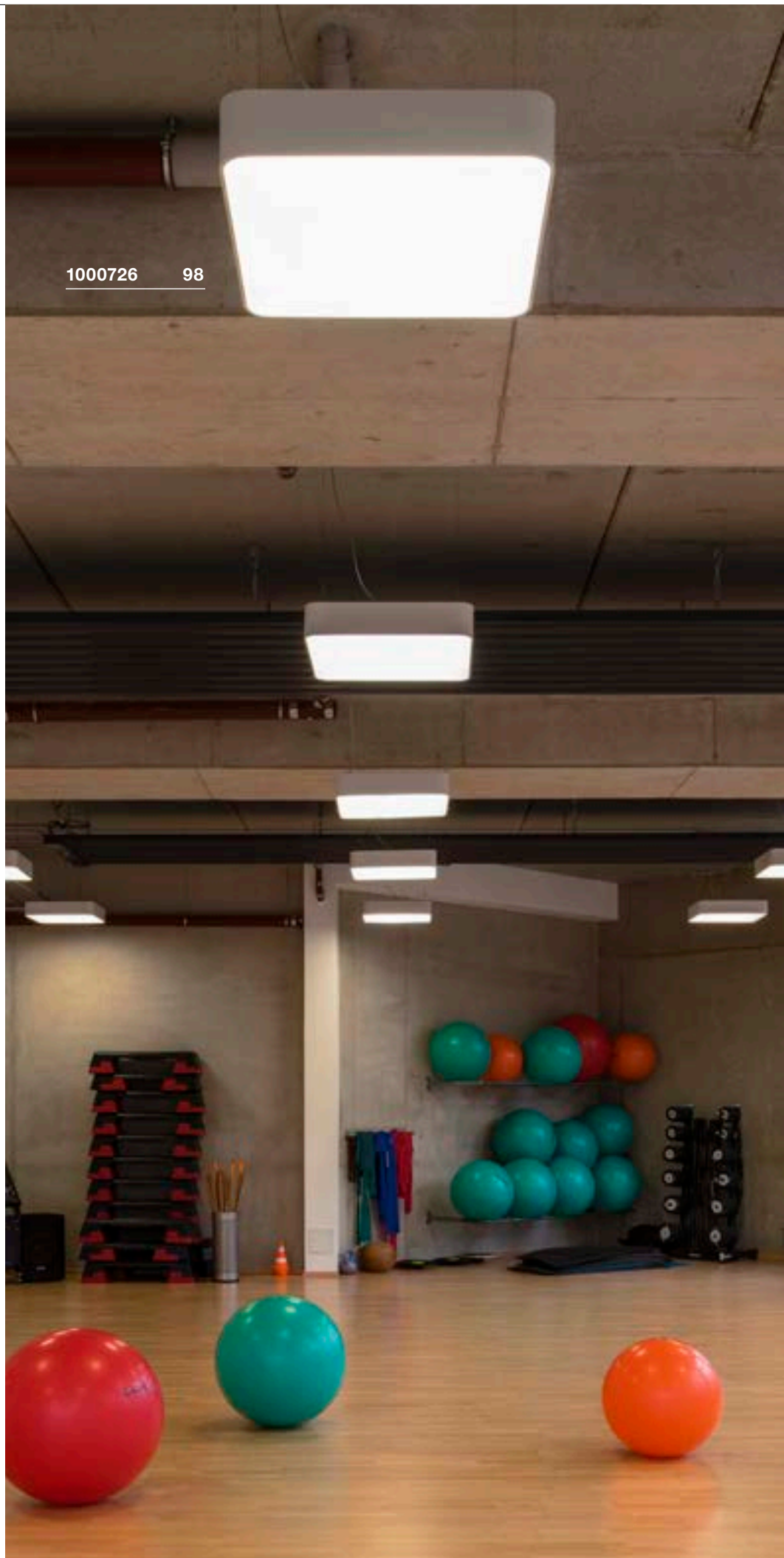

1000726 98

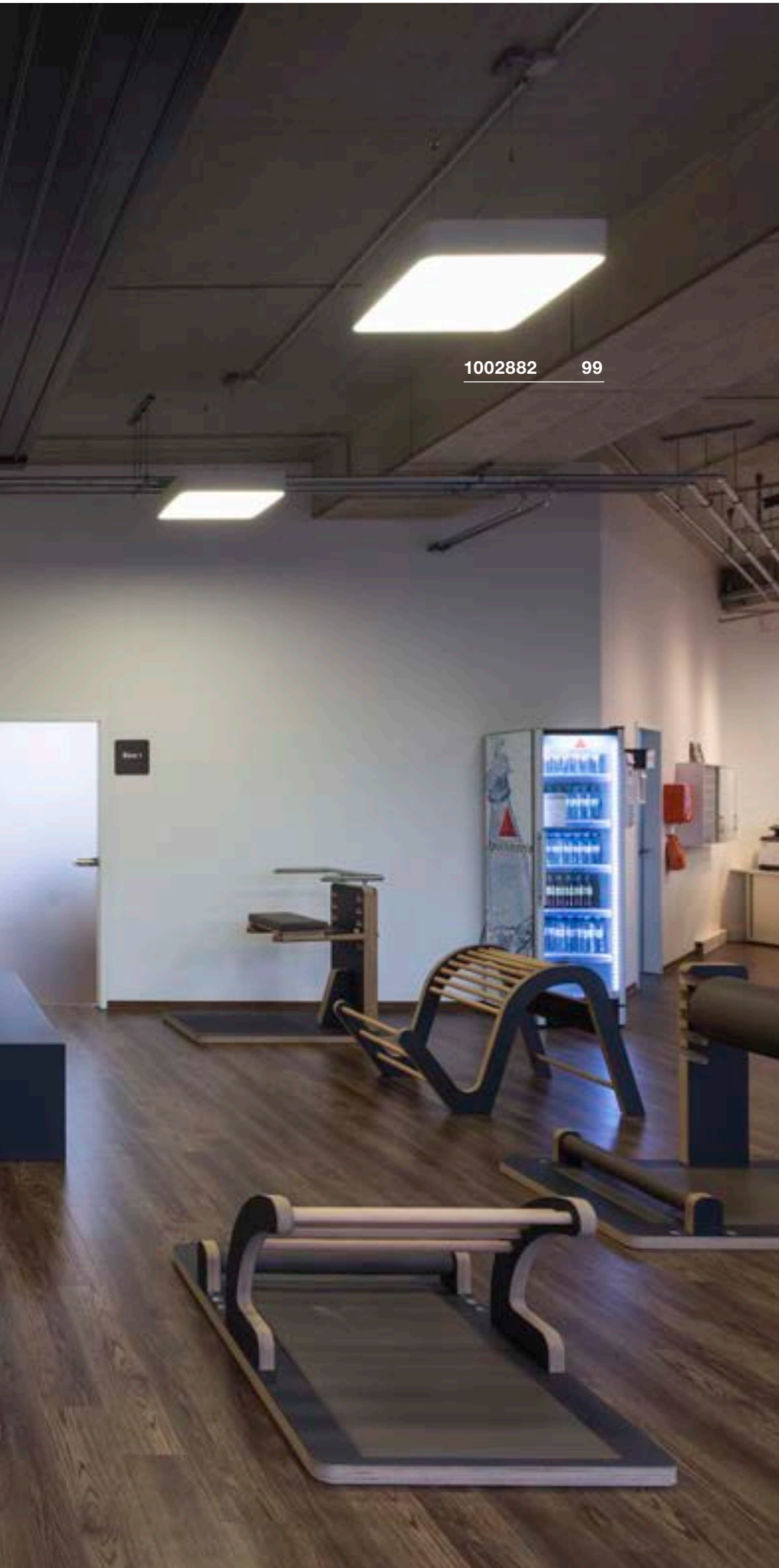

1002882 99

MEDO 60
CL, square, DALI



A-A++ Range A++-E

LED INSIDE

NEW VARIANT



- Can be converted into a pendant using the additionally available accessories

Product details

100-277V ~50/60Hz | 1000mA
Total consumption: 39W
Material: Aluminium / Acrylic
Dimmable: Dali

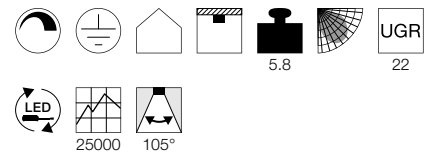

Dimensioned drawing

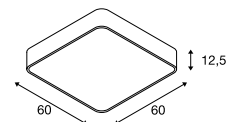

Note

Suspension set excl.

Recommended accessories

- Suspension set 1.5m
Item no. 135250
- Suspension set 1.5m
Item no. 135251
- Suspension set 1.5m
Item no. 135254
- Suspension set 5m
Item no. 1001950
- Suspension set 5m
Item no. 1001951
- Suspension set 5m
Item no. 1001952

Variant	Item no.
3300lm 3000K CRI>80 <input type="checkbox"/> white	1002882

MEDO RING 60
PD,1-10V



A-A++ Range A++-E



- Height adjustable

Product details

120-240V ~50/60Hz | 700mA
Total consumption: 35W
Material: Aluminium / Polymethylacrylate (PMMA)
Dimmable: 1-10V

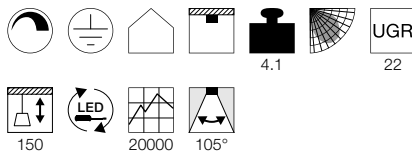

Dimensioned drawing

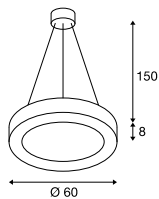

Recommended accessories

- 1-10V dimming



Item no. 470505

Variant	Item no.
2000lm 3000K CRI>80	
■ black	133840
2095lm 3000K CRI>80	
□ white	133841

MEDO RING 90
PD,1-10V



A-A++ Range A++-E

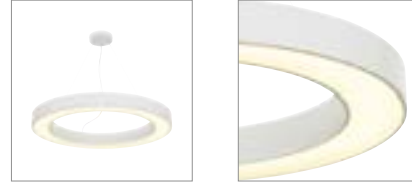

- Height adjustable

Product details

100-240V ~50/60Hz | 1200mA
Total consumption: 58W
Material: Aluminium / Polymethylacrylate (PMMA)
Dimmable: 1-10V

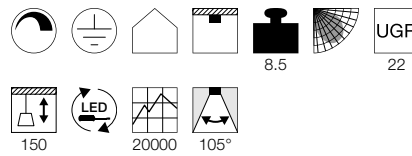

Dimensioned drawing

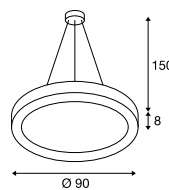

Recommended accessories

- 1-10V dimming



Item no. 470505

Variant	Item no.
3945lm 3000K CRI>80	
■ black	133850
4185lm 3000K CRI>80	
□ white	133851



133841

100



133850

100



1002890 101

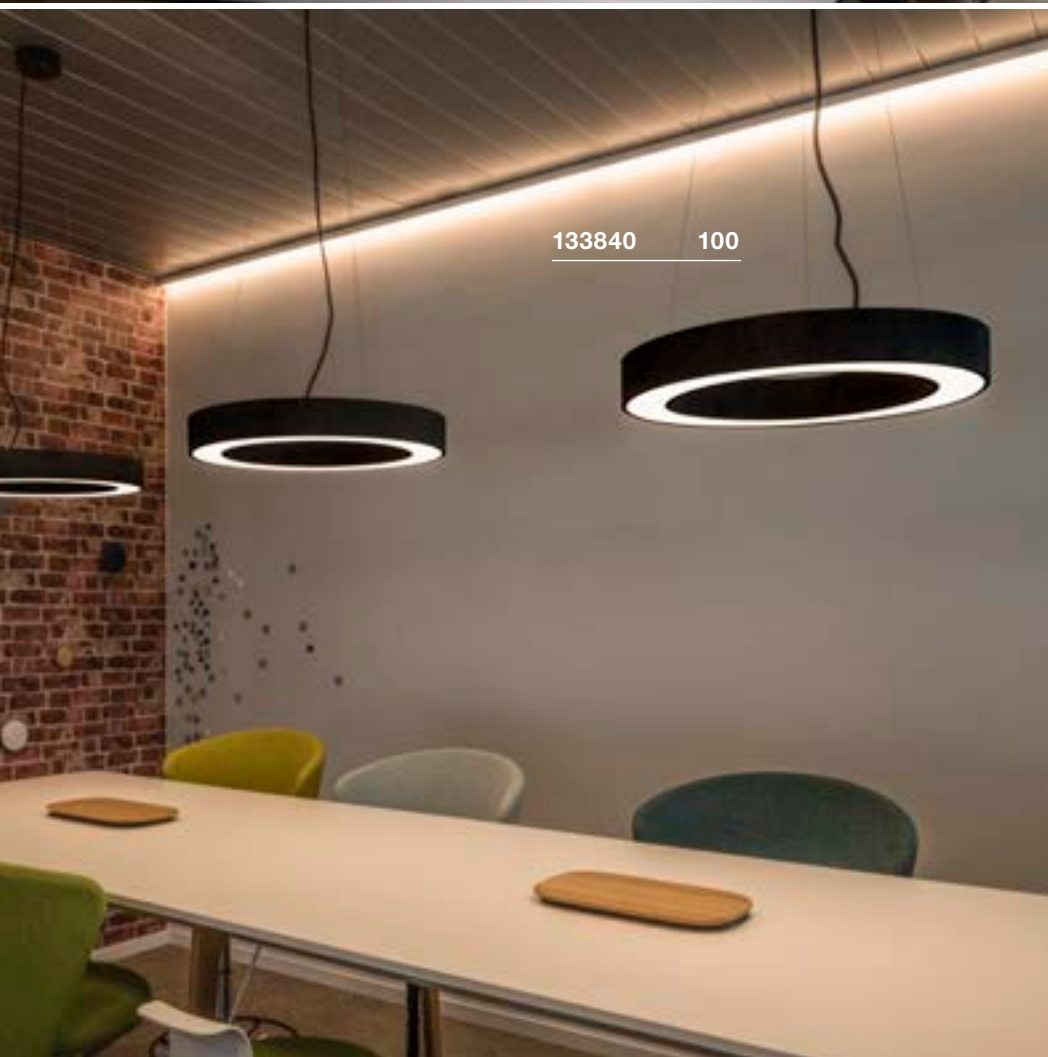

133840 100

MEDO RING 60
PD, DALI

891

A-A++ Range A++-E

LED INSIDE

NEW VARIANT



- Height adjustable

Product details

220-240V ~50/60Hz | 700mA
 Total consumption: 34W
 Material: Aluminium / Polymethylacrylate (PMMA)
 Dimmable: Dali

UGR 22
 4.1
 150
 LED
 20000
 105°

Dimensioned drawing

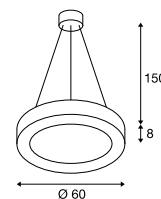

Variant	Item no.
2000lm 3000K CRI>80	
■ black	1002890
2095lm 3000K CRI>80	
□ white	1002891



1002913 103

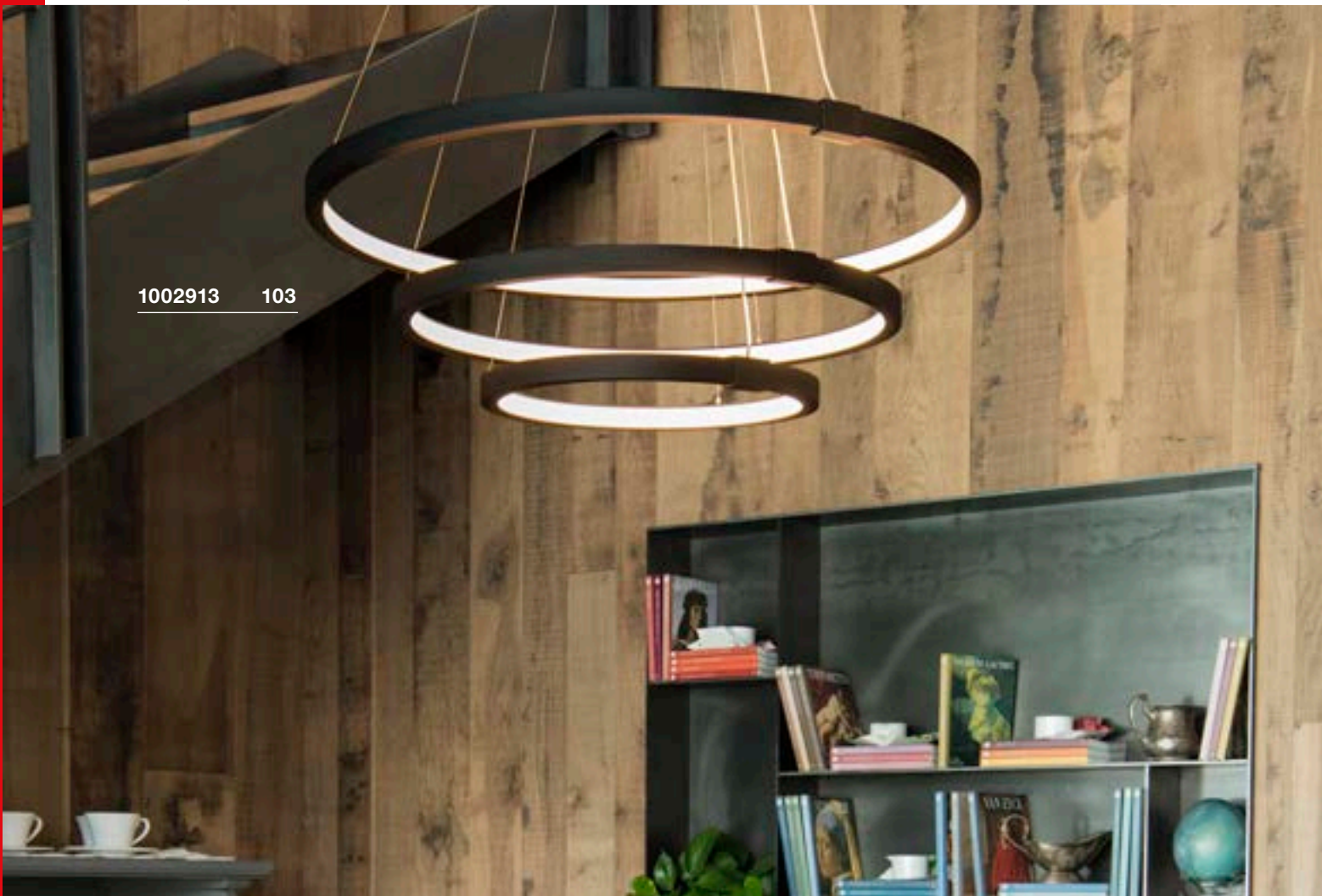

1002913 103

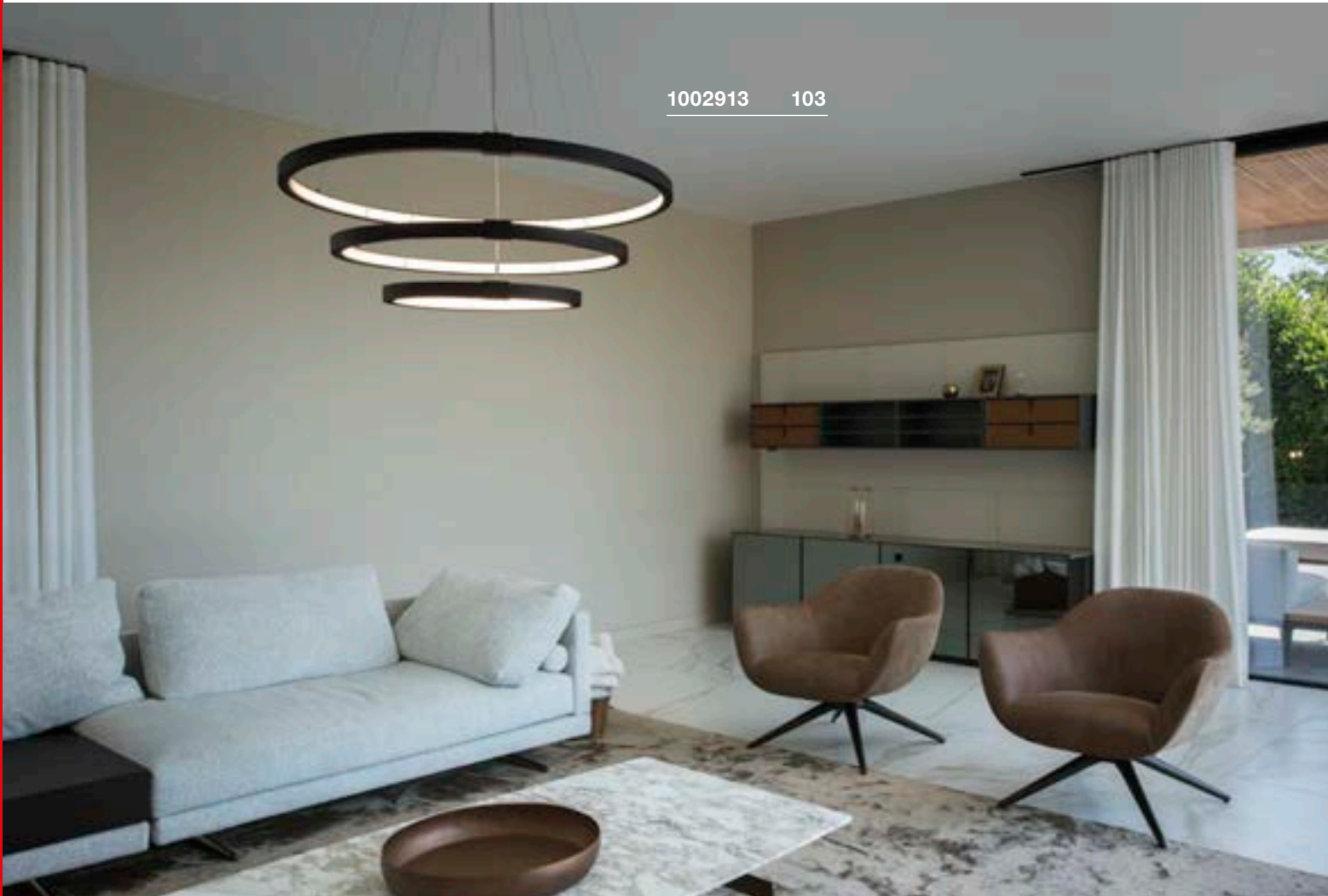

ONE TRIPLE PD, DALI

892

A-A++ Range A++-E

LED INSIDE

NEW



- Height adjustable
- Switchable light colour

Product details

220-240V 0/~50/60Hz | 1700mA
 Total consumption: 65W
 Material: Aluminium / Steel
 Dimmable: Dali
 Product dimensions: Ø: 80 cm L: 150 cm

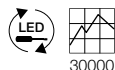
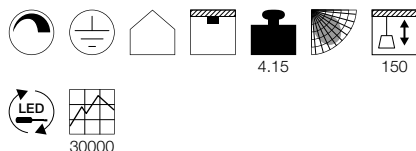

ONE 60 PD, DALI

892

A-A++ Range A++-E

LED INSIDE

NEW

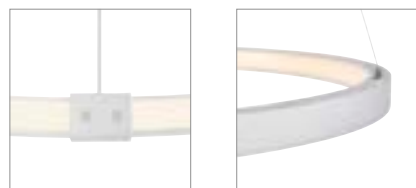

- Height adjustable
- Switchable light colour

Product details

220-240V ~50/60Hz | 600mA
 Total consumption: 25W
 Material: Aluminium / Steel
 Dimmable: Dali
 Product dimensions: Ø: 60 cm L: 150 cm

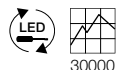
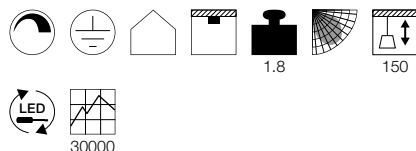

ONE 80 PD, DALI

892

A-A++ Range A++-E

LED INSIDE

NEW

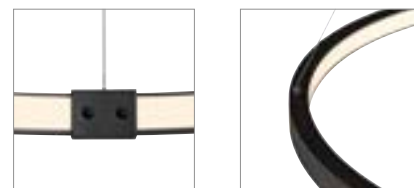

- Height adjustable
- Switchable light colour

Product details

220-240V ~50/60Hz | 800mA
 Total consumption: 35W
 Material: Aluminium / Steel
 Dimmable: Dali
 Product dimensions: Ø: 80 cm L: 150 cm

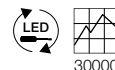
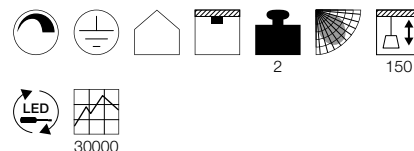

Variant	Item no.
3900/4200lm 3000/4000K CRI>80	
■ matt black	1002913
3900/4200lm 3000/4000K CRI>80	
□ matt white	1002914

Variant	Item no.
1400/1500lm 3000/4000K CRI>80	
■ matt black	1002909
1400/1500lm 3000/4000K CRI>80	
□ matt white	1002910

Variant	Item no.
2000/2200lm 3000/4000K CRI>80	
■ matt black	1002911
2000/2200lm 3000/4000K CRI>80	
□ matt white	1002912

PANEL 60
PD, 1-10V

A-A++ Range A++-E



- Height adjustable

Product details

100-240V ~50/60Hz | 1000mA
 Total consumption: 42W
 Material: Aluminium / Polymethylacrylate (PMMA)
 Dimmable: 1-10V

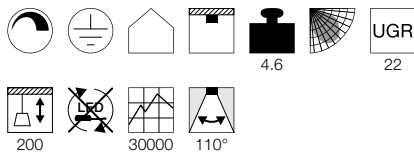

Dimensioned drawing

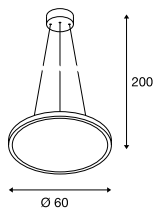

Recommended accessories

1-10V dimming
 Item no. 470505

Variant	Item no.
2850lm 2700K CRI>80 □ white	1001343
3150lm 3000K CRI>80 □ white	1001344
3350lm 4000K CRI>80 □ white	1001345
2850lm 2700K CRI>80 ■ grey	1001346
3150lm 3000K CRI>80 ■ grey	1001347
3350lm 4000K CRI>80 ■ grey	1001348

1001344 104





1003047 105

PANEL 60
PD, round, DALI

A-A++ Range A++-E

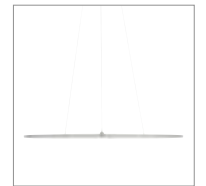

- Height adjustable

Product details

100-277V ~50/60Hz | 1000mA
 Total consumption: 42W
 Material: Aluminium / Polymethylacrylate (PMMA)
 Dimmable: Dali

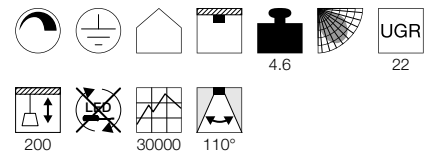

Dimensioned drawing

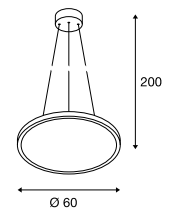

Variant	Item no.
3150lm 3000K CRI>80	
□ white	1003044
3350lm 4000K CRI>80	
□ white	1003045
3150lm 3000K CRI>80	
■ grey	1003046
3350lm 4000K CRI>80	
■ grey	1003047

1001447 107

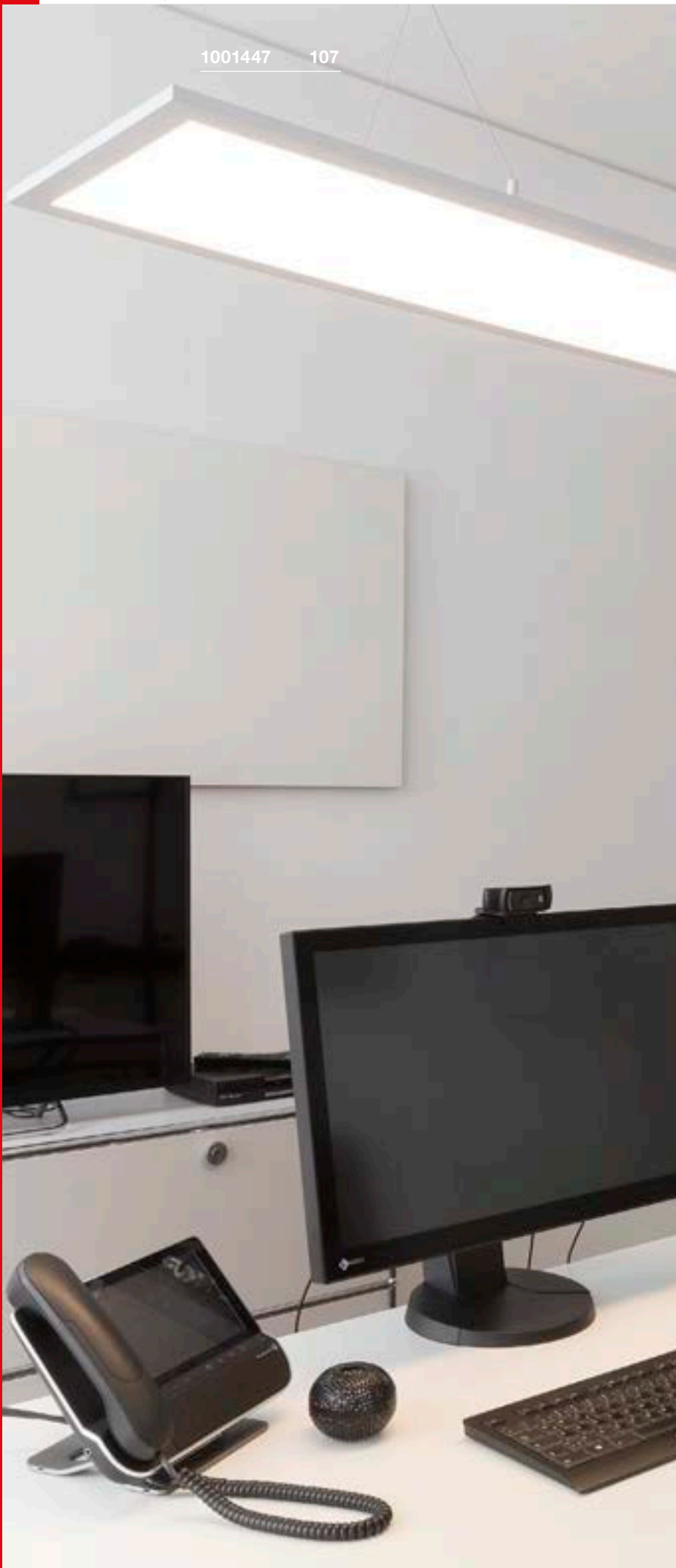

I-PENDANT PRO
PD, 1195x295mm,
UGR<22, 1-10V

A-A++ Range
A++-E

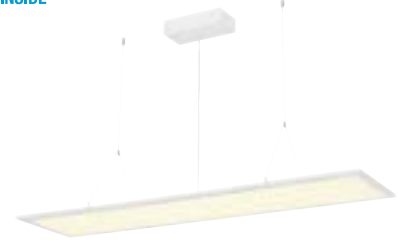

- UGR <22
- Height adjustable

Product details

100-240V ~50/60Hz | 1000mA
Total consumption: 42W
Material: Aluminium / Acrylic
Dimmable: 1-10V

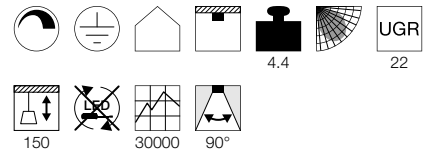

Dimensioned drawing

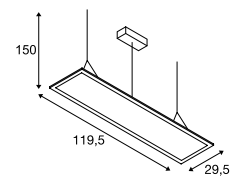

Recommended accessories

- 1-10V dimming
- Item no. 470505



Variant	Item no.
3300lm 3000K CRI>80	
<input type="checkbox"/> white	158853
3600lm 4000K CRI>80	
<input type="checkbox"/> white	158854

I-PENDANT PRO
PD, 1195x295mm, 1-10V

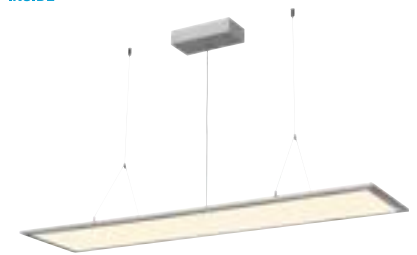

- Height adjustable

Product details

100-240V ~50/60Hz | 1000mA
Total consumption: 42W
Material: Aluminium / Acrylic
Dimmable: 1-10V

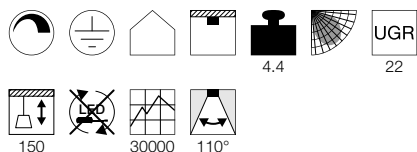

Dimensioned drawing

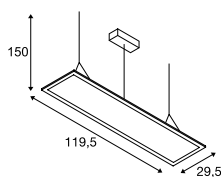

Recommended accessories

1-10V dimming
Item no. 470505

Variant	Item no.
3100lm 3000K CRI>80 <input type="checkbox"/> matt white	158723
3550lm 4000K CRI>80 <input type="checkbox"/> matt white	158724
3100lm 3000K CRI>80 <input checked="" type="checkbox"/> grey	158733
3550lm 4000K CRI>80 <input checked="" type="checkbox"/> grey	158734

I-PENDANT PRO
PD, 1195x295mm,
UGR<19, 1-10V

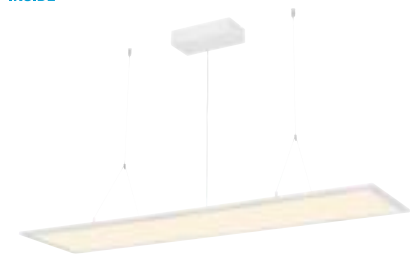

- Height adjustable
- Reduced glare due to UGR <19
- Workstation-compatible

Product details

100-240V ~50/60Hz | 1000mA
Total consumption: 42W
Material: Aluminium / Polymethylacrylate (PMMA)
Dimmable: 1-10V

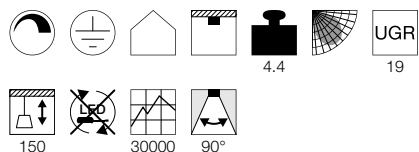

Dimensioned drawing

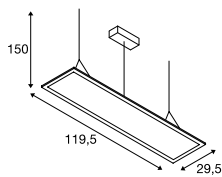

Recommended accessories

1-10V dimming
Item no. 470505

Variant	Item no.
3750lm 3000K CRI>80 <input type="checkbox"/> white	1001447
3800lm 4000K CRI>80 <input type="checkbox"/> white	1001448
3750lm 3000K CRI>80 <input checked="" type="checkbox"/> grey	1001647
3800lm 4000K CRI>80 <input checked="" type="checkbox"/> grey	1001648

I-PENDANT PRO
PD, 1195x295mm, DALI

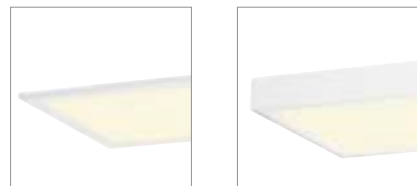

- Height adjustable
- Suitable for screen workplaces in accordance with EN 12464-1
- UGR<19

Product details

100-277V ~50/60Hz | 1000mA
Total consumption: 42W
Material: Aluminium / Polymethylacrylate (PMMA)
Dimmable: Dali

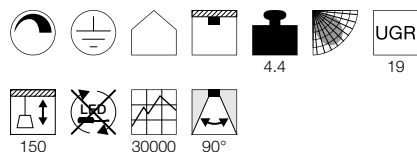

Dimensioned drawing

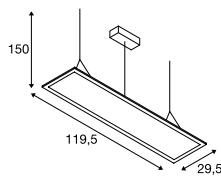

Recommended accessories

1-10V dimming
Item no. 470505

Variant	Item no.
3750lm 3000K CRI>80 <input type="checkbox"/> white	1003048
3800lm 4000K CRI>80 <input type="checkbox"/> white	1003049
3750lm 3000K CRI>80 <input checked="" type="checkbox"/> grey	1003050
3800lm 4000K CRI>80 <input checked="" type="checkbox"/> grey	1003051

HANG UP 120
PD, TRIAC

A-A++ Range A++-E

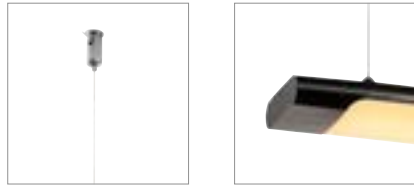

- Height adjustable

Product details

220-240V ~50/60Hz | 250mA
Total consumption: 41W
Material: Aluminium / Plastic
Dimmable: Triac C

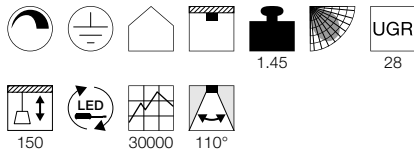

Dimensioned drawing

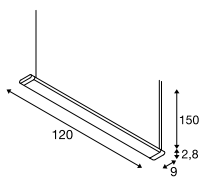

Note

Canopy excl.
Open cable end

Recommended accessories

- Ceiling plate
Item no. 210060
- Ceiling plate
Item no. 210061
- Ceiling plate
Item no. 210064

Variant	Item no.
4000lm 3000K CRI>80 ■ black	160900
4000lm 3000K CRI>80 □ white	160901
4000lm 3000K CRI>80 ■ grey	160904

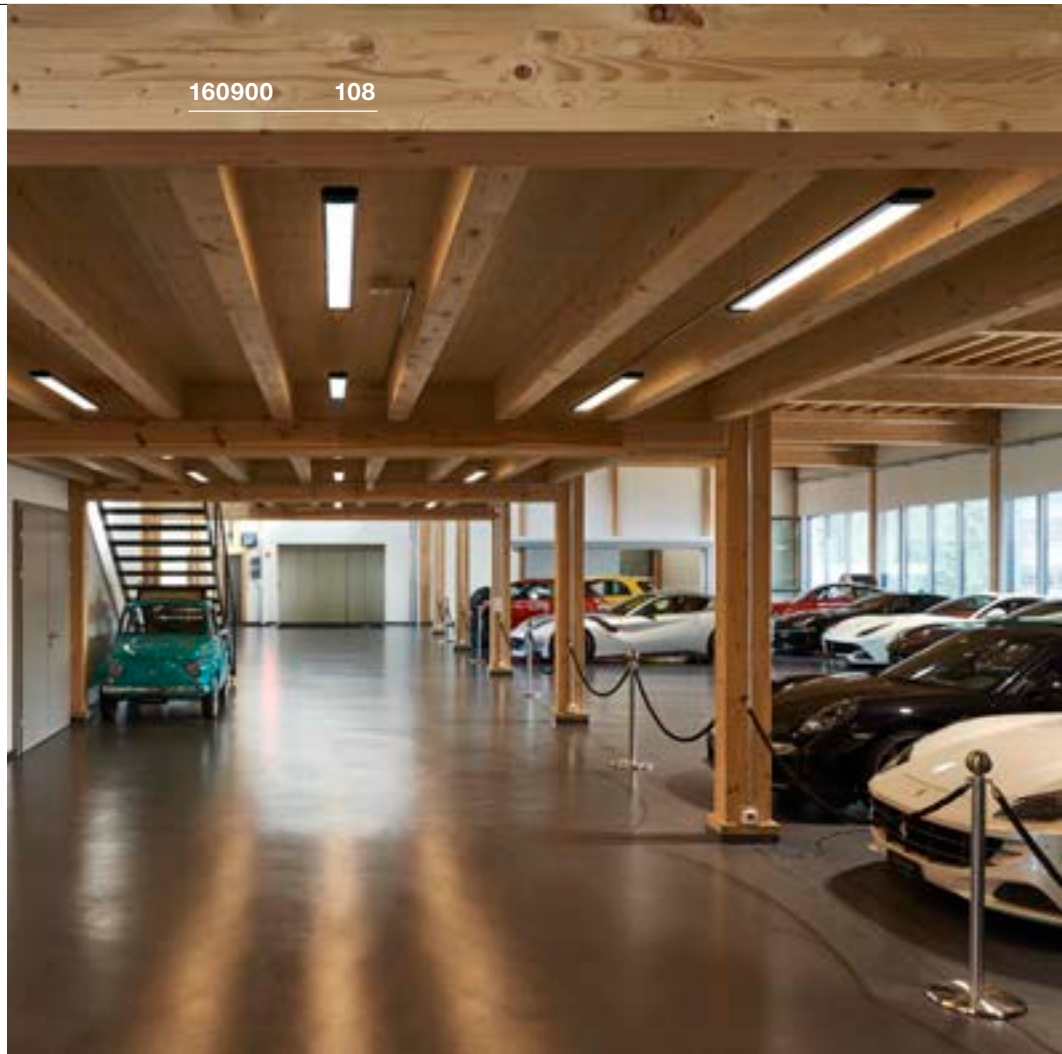



160904

108



LUMINAIRE HIGHLIGHTS

OUR PERFECT LIGHT FOR YOUR WORKPLACE

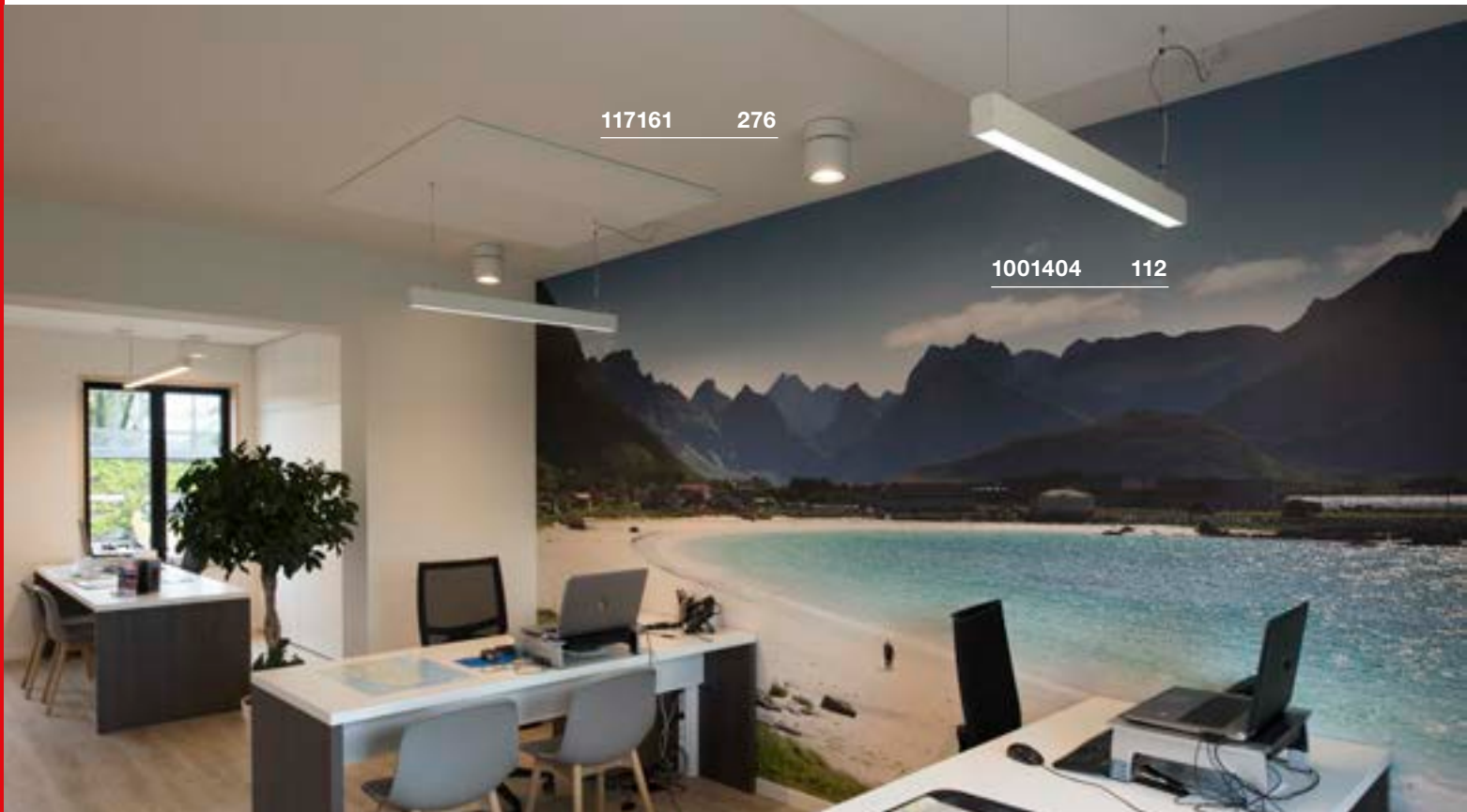

GLENOS® 1m | 2m | 112

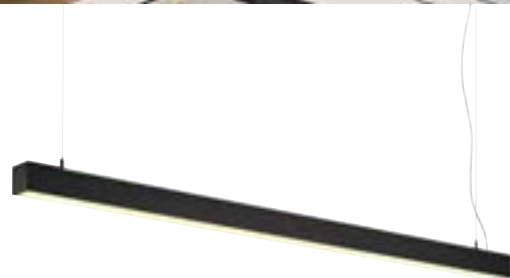

Q-LINE® PD, single | 113



Q-LINE® PD, DALI single | 113



1001306 113

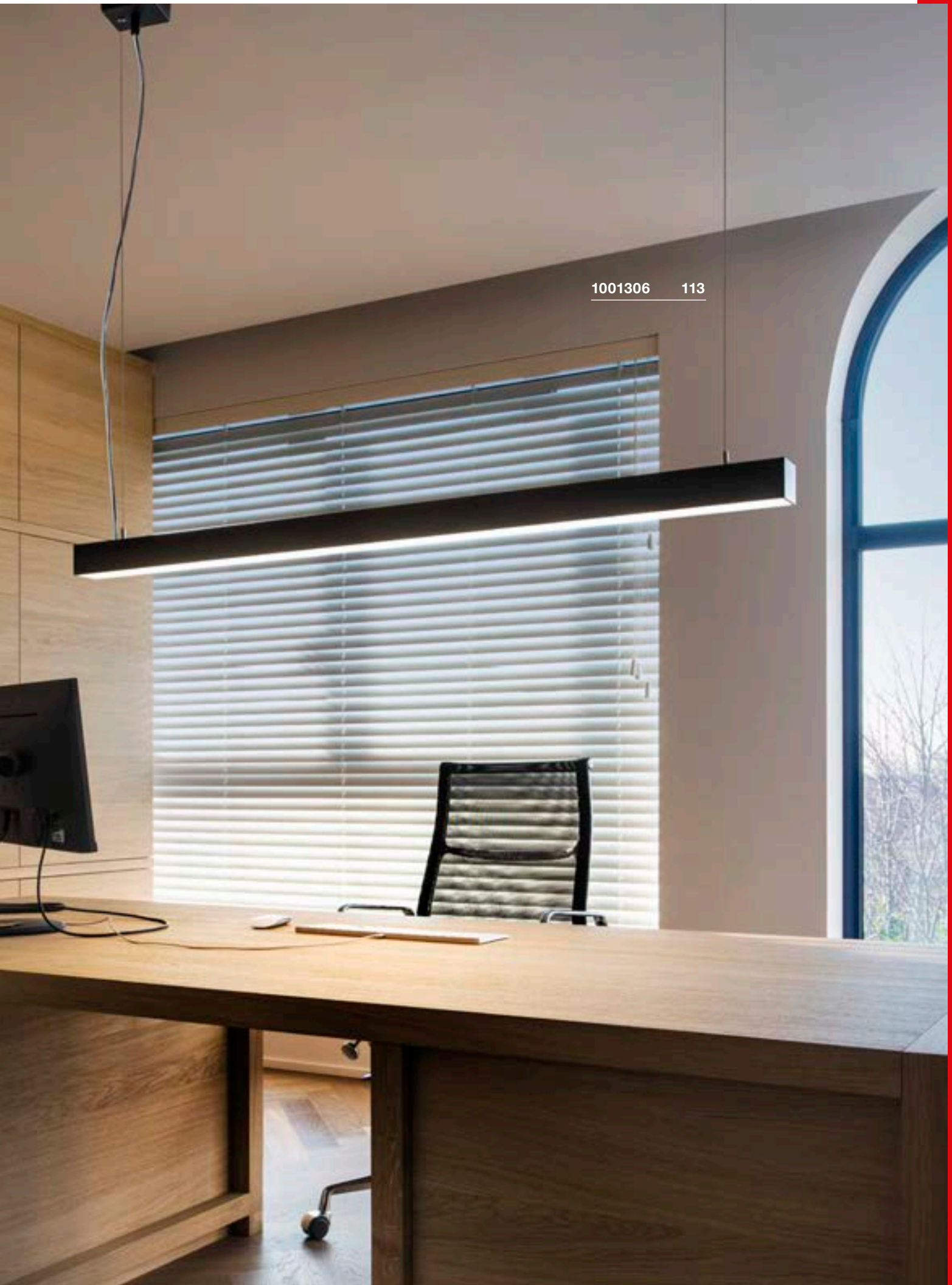

GLENOS
PD, 1m, 1-10V

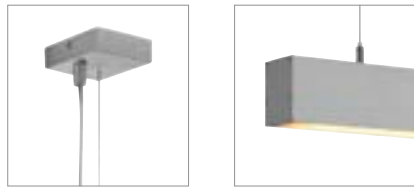

Product details

220-240V ~50/60Hz | 1000mA
Total consumption: 43W
Material: Aluminium / Plastic
Dimmable: 1-10V

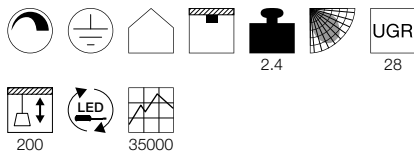

Dimensioned drawing

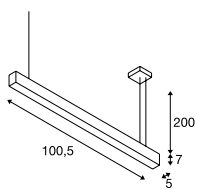

GLENOS
PD, 2m, 1-10V



Product details

220-240V ~50/60Hz | 1000mA
Total consumption: 85W
Material: Aluminium / Plastic
Dimmable: 1-10V

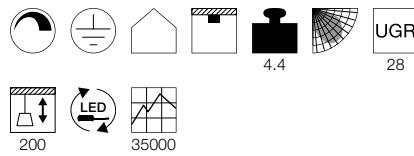

Dimensioned drawing

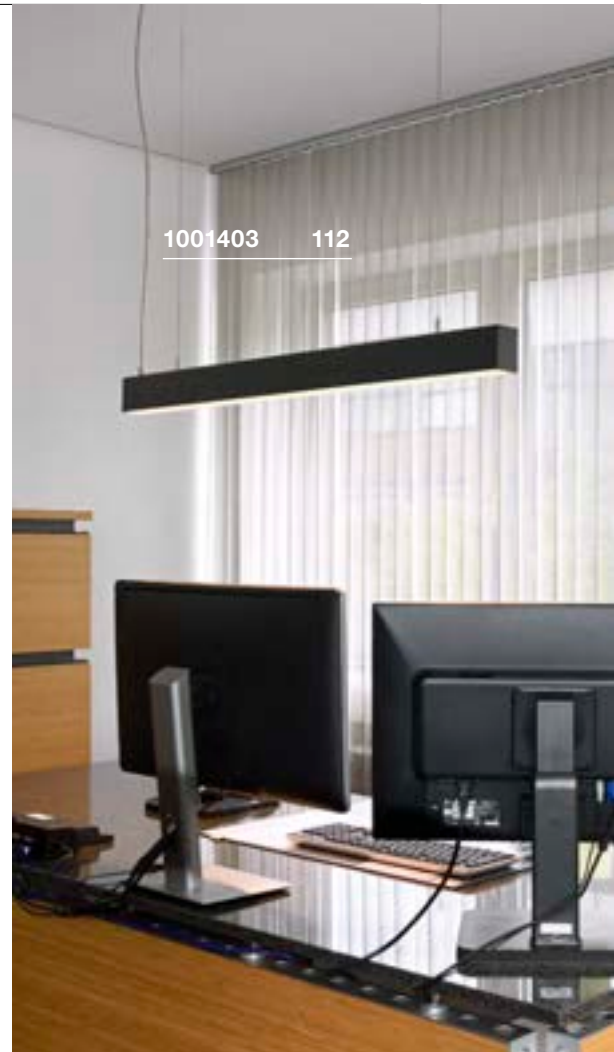
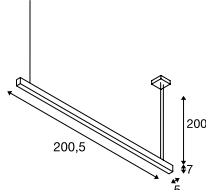

Variant	Item no.
2850lm 3000K CRI>80 ■ matt black	1001400
2850lm 3000K CRI>80 □ matt white	1001401
2850lm 3000K CRI>80 ■ silver	1001402
3300lm 4000K CRI>80 ■ matt black	1001403
3300lm 4000K CRI>80 □ matt white	1001404
3300lm 4000K CRI>80 ■ silver	1001405

Variant	Item no.
5700lm 3000K CRI>80 ■ matt black	1001406
5700lm 3000K CRI>80 □ matt white	1001407
5700lm 3000K CRI>80 ■ silver	1001408
6600lm 4000K CRI>80 ■ matt black	1001409
6600lm 4000K CRI>80 □ matt white	1001410
6600lm 4000K CRI>80 ■ silver	1001411



1001306 113



Q-LINE®
PD, single



A-A++ Range A++-E

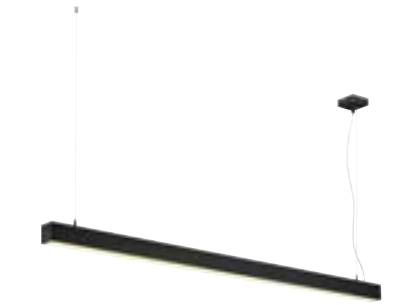

- Height adjustable

Product details

220-240V ~50/60Hz | 700mA
Total consumption: 45.8W
Material: Aluminium / Acrylic

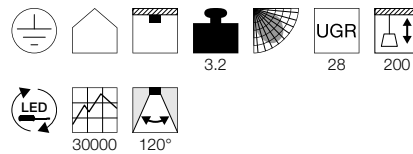

Dimensioned drawing

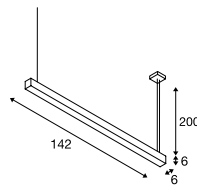

Q-LINE®
PD, DALI, single



A-A++ Range A++-E



LED
INSIDE

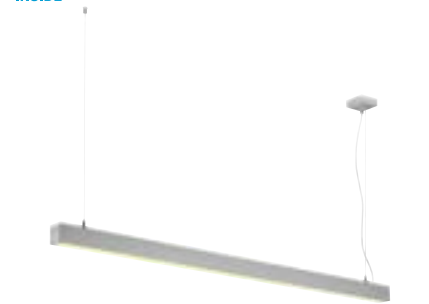

- Height adjustable

Product details

220-240V ~50/60Hz | 350mA-1050mA
Total consumption: 47W
Material: Aluminium / Acrylic
Dimmable: Dali, switch

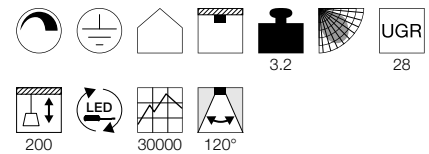

Dimensioned drawing

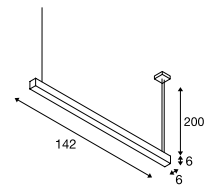

Variant	Item no.
3700lm 3000K CRI>80	
■ black	1001306
3700lm 3000K CRI>80	
□ white	1001307
3700lm 3000K CRI>80	
■ grey	1001308

Variant	Item no.
3700lm 3000K CRI>80	
■ black	1001309
3700lm 3000K CRI>80	
□ white	1001310
3700lm 3000K CRI>80	
■ grey	1001312

Q-LINE®
PD, 1m, BAP, TRIAC



A-A++ Range
A++-E



- Premium LED with CRI>90
- Height adjustable

Product details

220-240V ~50/60Hz | 900mA
Total consumption: 45W
Material: Aluminium / Plastic
Dimmable: Triac L

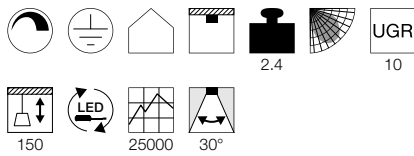

Dimensioned drawing

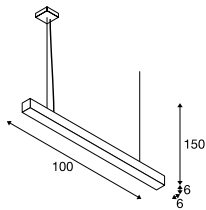

Q-LINE®
PD, 2m, BAP, TRIAC



A-A++ Range
A++-E



- Premium LED with CRI>90
- Height adjustable

Product details

220-240V ~50/60Hz | 900mA
Total consumption: 85W
Material: Aluminium / Plastic
Dimmable: Triac L

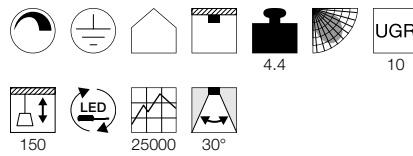

Dimensioned drawing

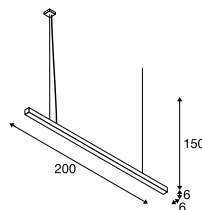

Variant	Item no.
2100lm 3000K CRI>90 ■ white	1000926
2100lm 3000K CRI>90 ■ black	1000927
2100lm 3000K CRI>90 ■ grey	1000928
2300lm 4000K CRI>90 ■ white	1000932
2300lm 4000K CRI>90 ■ black	1000933
2300lm 4000K CRI>90 ■ grey	1000934

Variant	Item no.
4200lm 3000K CRI>90 ■ white	1000929
4200lm 3000K CRI>90 ■ black	1000930
4200lm 3000K CRI>90 ■ grey	1000931
4600lm 4000K CRI>90 ■ white	1000935
4600lm 4000K CRI>90 ■ black	1000936
4600lm 4000K CRI>90 ■ grey	1000937



1000926 114



1000934 114

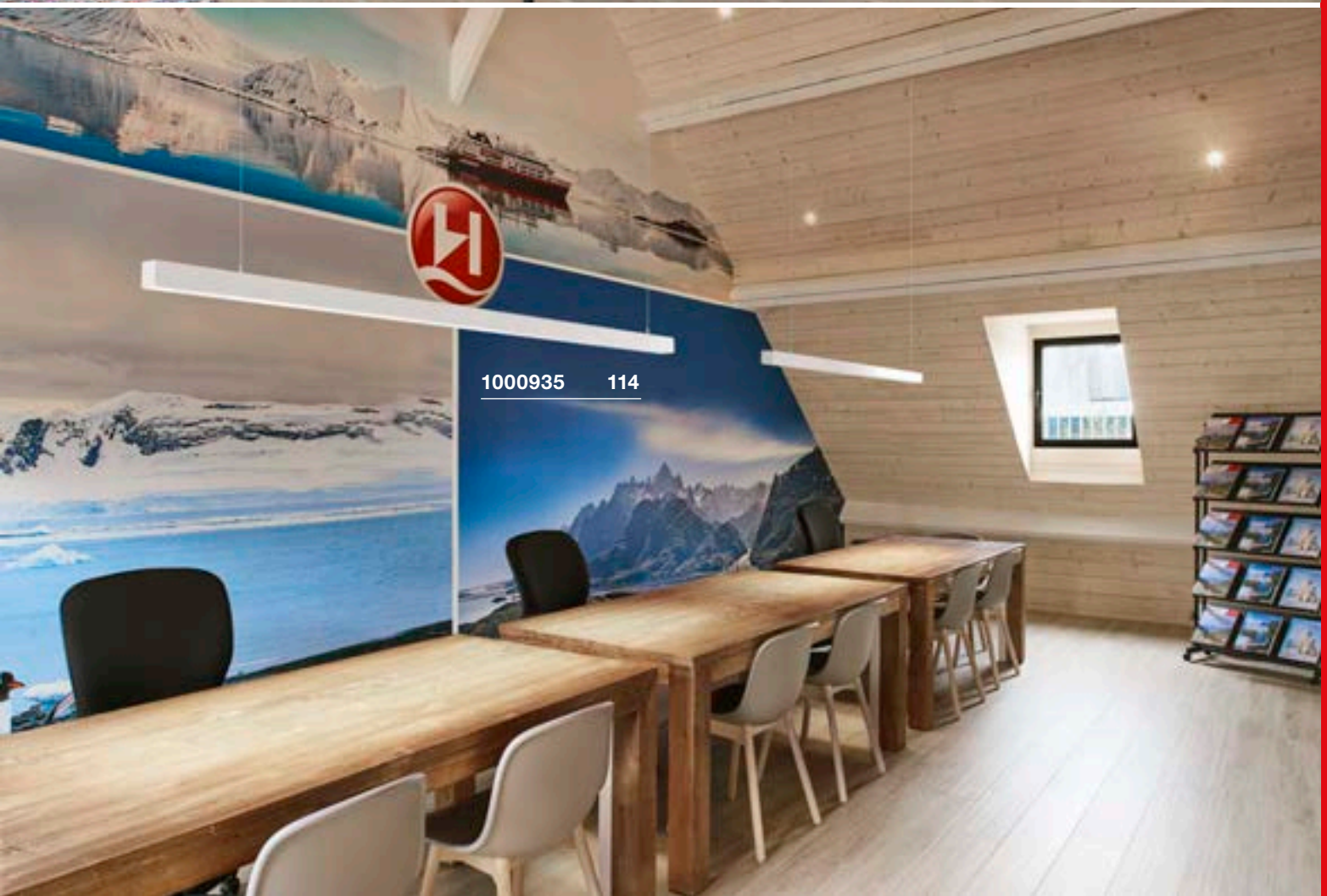
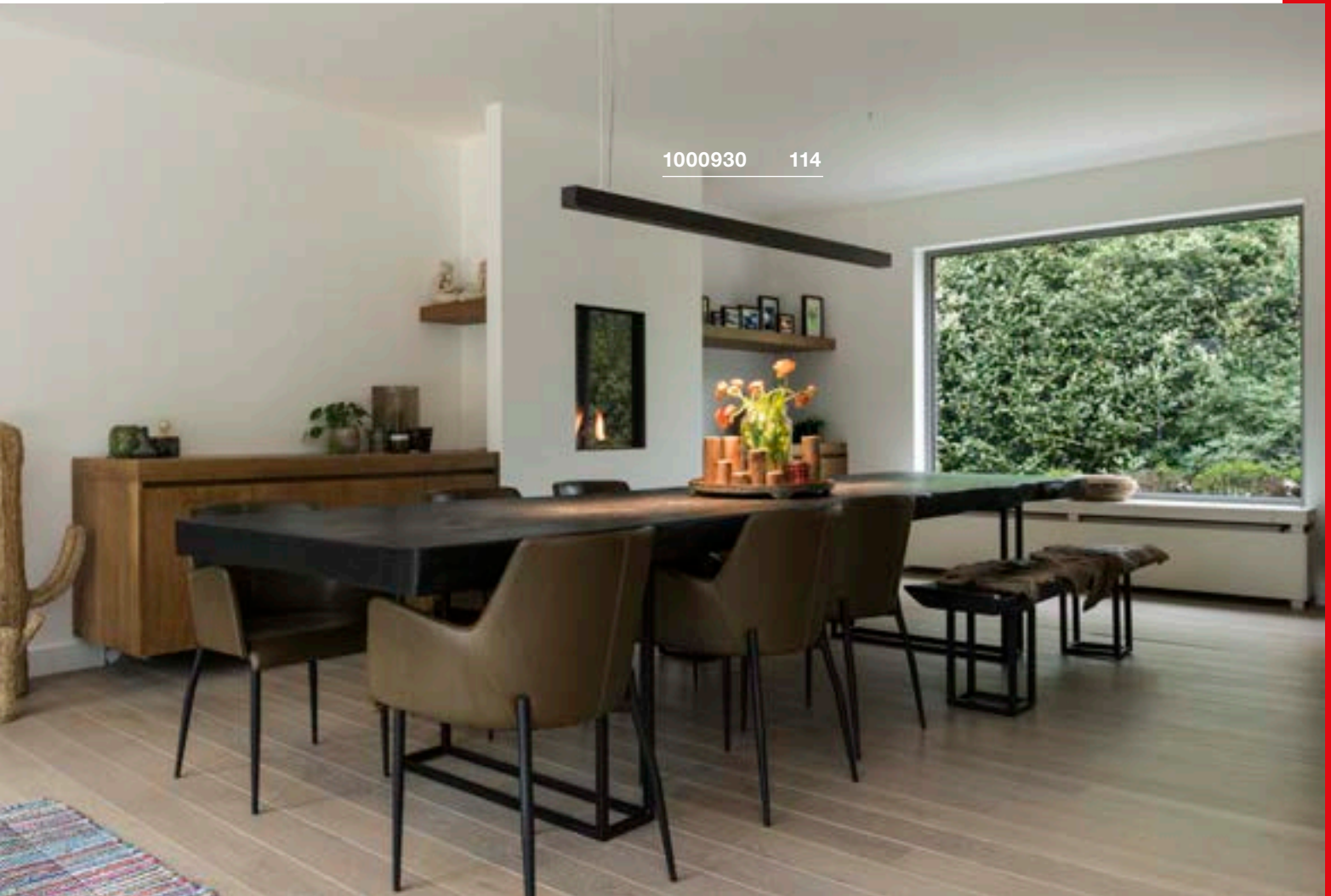

OPEN GRILL
PD, Single Twist



A-A++ Range
A++-E

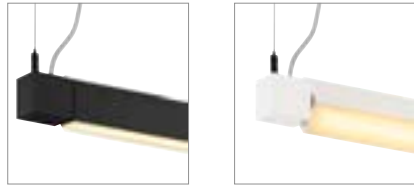

- Height adjustable

Product details

220-240V ~50/60Hz | 700mA
Total consumption: 38W
Material: Aluminium / Acrylic

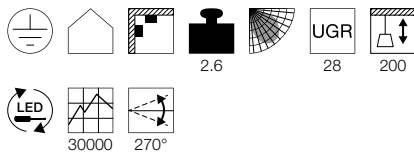

Dimensioned drawing

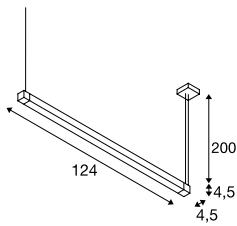

OPEN GRILL
PD, Double Twist



A-A++ Range
A++-E

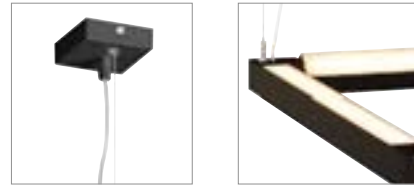

- Height adjustable

Product details

220-240V ~50/60Hz | 1050mA
Total consumption: 54W
Material: Aluminium / Acrylic

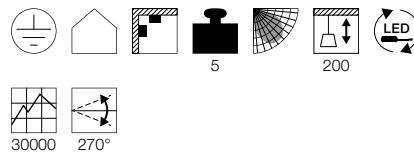

Dimensioned drawing

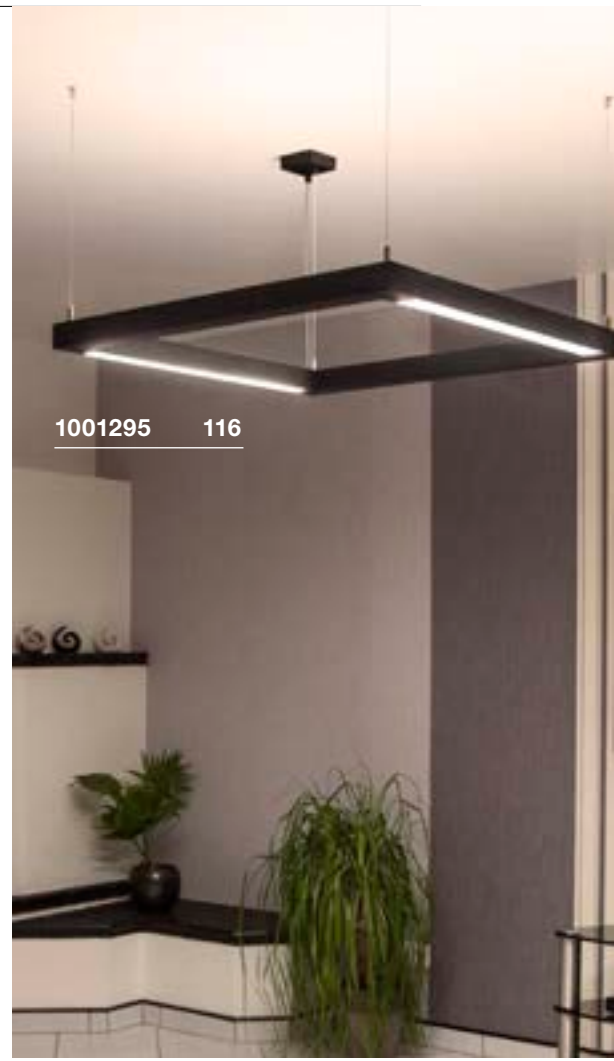
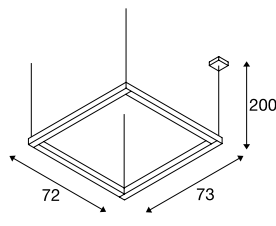

1001295 116

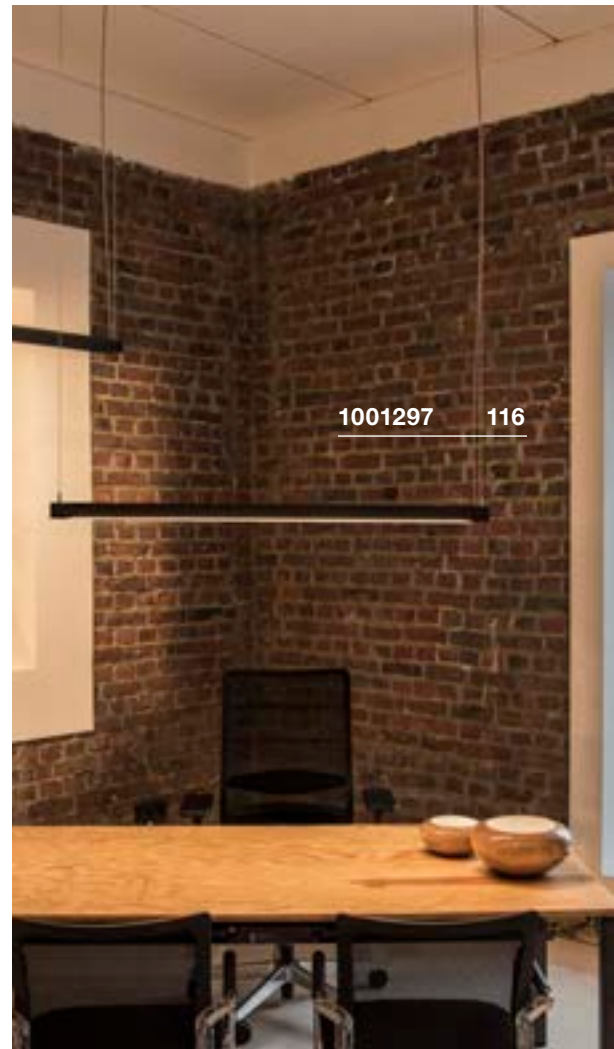

1001297 116

Variant	Item no.
3160lm 3000K CRI>80	
■ black	1001297
2500lm 3000K CRI>80	
□ white	157671

Variant	Item no.
4500lm 3000K CRI>80	
■ black	1001295
4500lm 3000K CRI>80	
□ white	1001296



159140 117

AIXLIGHT® 150
PD, R2 Office, TR C



E-A++ Range A++-E



LED INSIDE

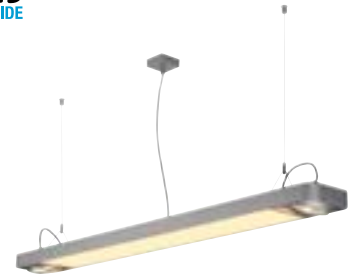

Product details

220-240V ~50/60Hz | 700mA
Total consumption: 35W
Material: Aluminium / Steel
Dimmable: Triac C, Triac L

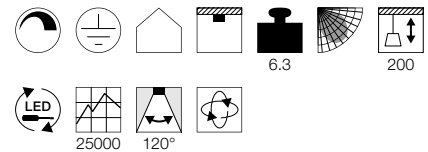

Dimensioned drawing

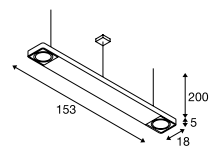

Recommended lamp

GU10 7.9W 40°
4000K 760lm EEL=A+
8kWh/1000h
Item no. 560734



LED GU10 13W 140°
4000K 1100lm EEL=A+
13kWh/1000h
Item no. 1001245



Lamp details

2x max. 75W QPAR111

Variant	Item no.
GU10 QPAR111 4100lm 4000K CRI>80	
■ black	159140
GU10 QPAR111 4100lm 4000K CRI>80	
□ white	159141
GU10 QPAR111 4100lm 4000K CRI>80	
■ grey / matt transparent	159144

AIXLIGHT®
PD, R2, double, QPAR111

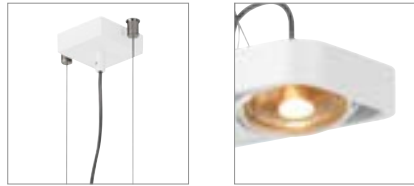

AIXLIGHT®
PD, R2, quad, QPAR111



AIXLIGHT®
PD, R2, quad, QPAR111

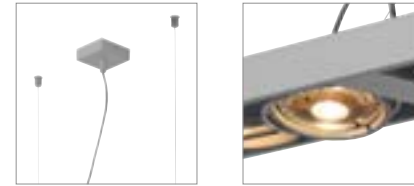

Product details

230V ~50Hz
Material: Aluminium

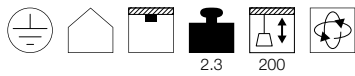

Dimensioned drawing

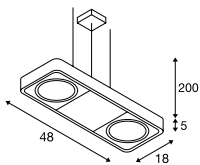

Product details

230V ~50Hz
Material: Aluminium

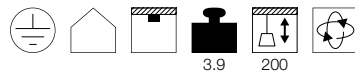

Dimensioned drawing

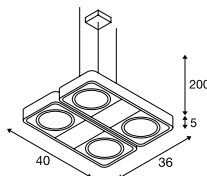

Product details

230V ~50Hz
Material: Aluminium

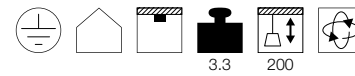

Dimensioned drawing

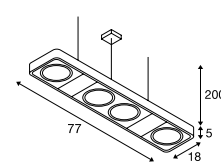

Recommended lamp

LED GU10 17.5W 140°
2700K 750lm EEL=A
18kWh/1000h
Item no. 570532



LED GU10 13W 30°
4000K 1300lm EEL=A+
13kWh/1000h
Item no. 1001243



Recommended lamp

GU10 6.5W 38°
2700K 390lm EEL=A+
7kWh/1000h
Item no. 551882



LED GU10 10W 38°
3000K 630lm EEL=A+
10kWh/1000h
Item no. 1001029



Recommended lamp

GU10 7W 40°
3000K 560lm EEL=A+
8kWh/1000h
Item no. 1001572



LED GU10 9W 40°
2700-6500K 765lm EEL=A+
9kWh/1000h
Item no. 1001921



Lamp details

2x max. 75W QPAR111

Lamp details

4x max. 75W QPAR111

Lamp details

4x max. 75W QPAR111

Variant	Item no.
GU10 QPAR111	
■ black	159210
GU10 QPAR111	
□ white	159211
GU10 QPAR111	
■ grey	159214

Variant	Item no.
GU10 QPAR111	
■ black	159230
GU10 QPAR111	
□ white	159231
GU10 QPAR111	
■ grey	159234

Variant	Item no.
GU10 QPAR111	
■ black	159220
GU10 QPAR111	
□ white	159221
GU10 QPAR111	
■ grey	159224



159230 118



1000412 119

LYNAH
PD, quad

 890

A-A++ Range A++-E

LED INSIDE



- Luminaire can be rotated in multiple directions. Swivels by 180°.

Product details

220-240V ~50/60Hz | 350mA
Total consumption: 56W
Material: Aluminium / Polycarbonate (PC)
Dimmable: Triac C

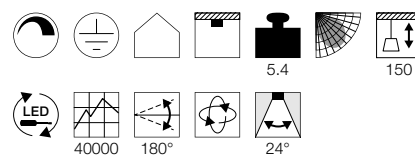

Dimensioned drawing

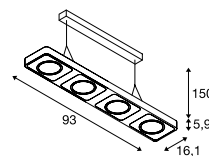

Variant	Item no.
3800lm 3000K CRI>80	
■ black	1000412
3800lm 3000K CRI>80	
□ white	1000413

WORKLIGHT
PD, DALI

 898

A-A++ Range
A++-E



NEW
VARIANT

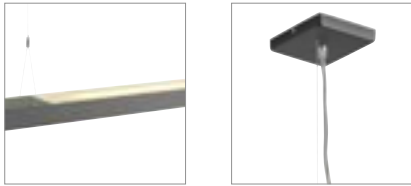
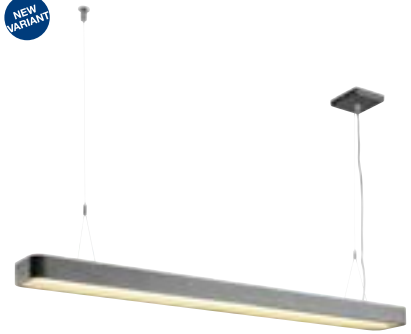

- Height adjustable
- Direct and indirect light

Product details

220-240V ~50/60Hz | 226mA
Total consumption: 49W
Material: Aluminium / Acrylic
Dimmable: Dali

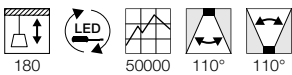
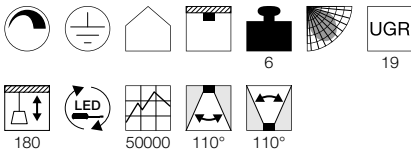

Dimensioned drawing

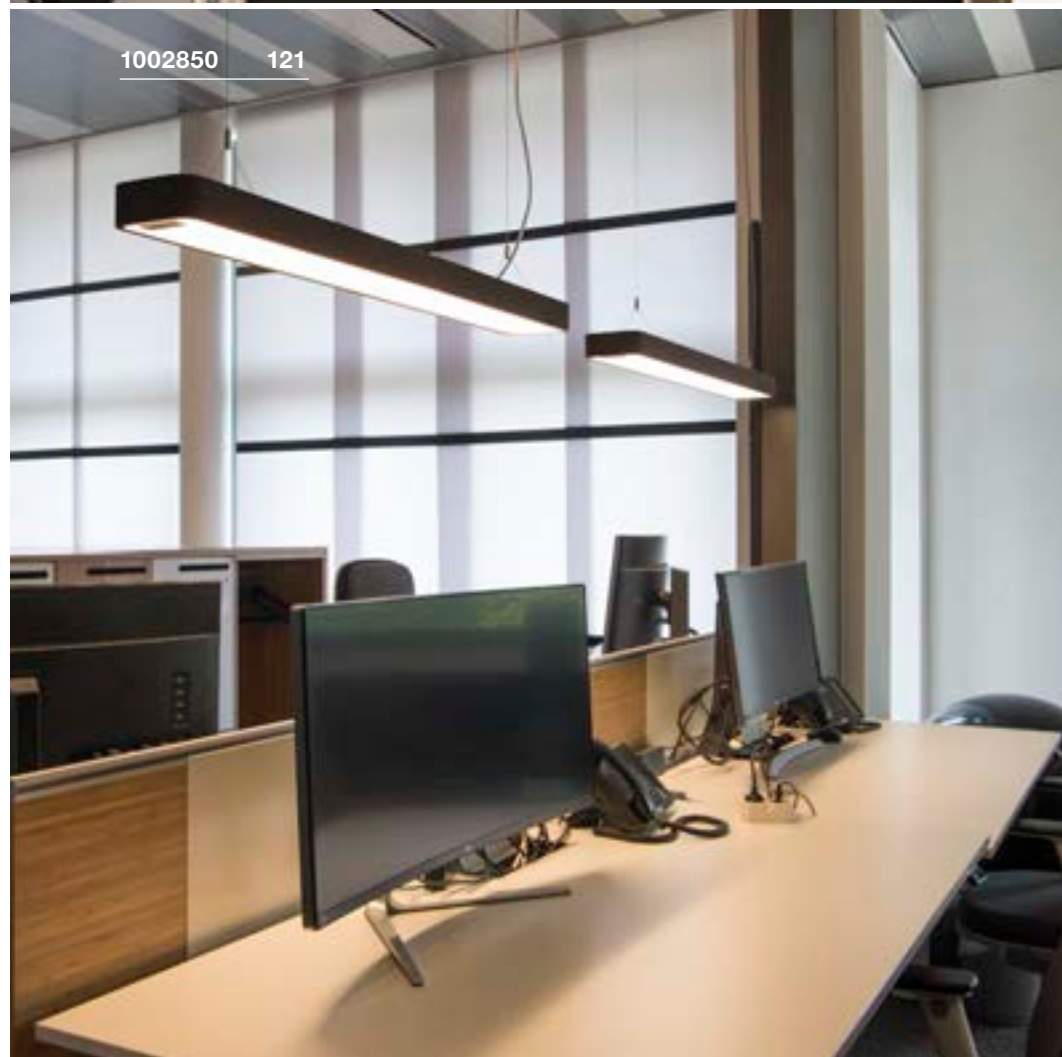
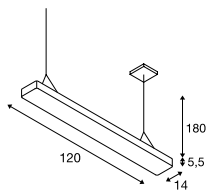

Variant	Item no.
Direct: 3600lm 3000K CRI>80 Indirect: 1800lm 3000K CRI>80	
<input type="checkbox"/> white	1002838
Direct: 3600lm 3000K CRI>80 Indirect: 1800lm 3000K CRI>80	
<input type="checkbox"/> anthracite	1002839

WORKLIGHT PLUS
PD, DALI



A-A++ Range A++-E

LED
INSIDE

NEW VARIANTS

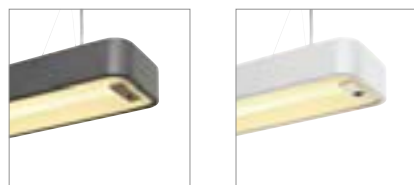

- Intelligent presence control and brightness sensor
- Direct and indirect light

Product details

220-240V ~50/60Hz | 226mA
Total consumption: 48W
Material: Aluminium / Acrylic
Dimmable: Dali

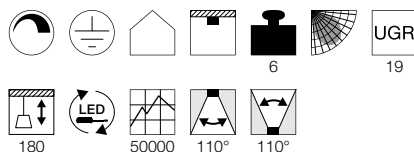

Dimensioned drawing

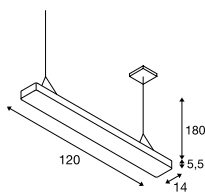

Variant	Item no.
Direct: 3600lm 3000K CRI>80 Indirect: 1920lm 3000K CRI>80	
white	1002849
Direct: 3600lm 3000K CRI>80 Indirect: 1920lm 3000K CRI>80	
anthracite	1002850



INTELLIGENT WORKPLACE LIGHT FOR THE MODERN OFFICE

Energy efficient and long-lasti

Our WORKLIGHT PLUS PD, DALI pendant for workstations (UGR ≤19) impresses with its clear design, state-of-the-art technology and powerful LEDs with a service life of 50,000 from Philips. The energy saving potential is optimized due being equipped with intelligent light control. Thanks to the integrated presence control, the light switches on and off automatically depending on movement, and the lumen output is controlled by the daylight sensor. This ensures that there is a consistent light level at the workplace. Another highlight is the capability of setting the background level (10%-70% lumen output), which also increases comfort. The combination of direct and indirect light output provides widespread and homogeneous illumination.

Luminaire grouping and individual settings for open plan office are also possible with the programmable infrared remote control (up to 50 luminaires). Simple retrofitting with the WORKLIGHT PLUS PD, DALI pendant after office renovation – not a problem. Thanks to the possibility of wireless control and programming (wireless DALI), the mobile workplace light can easily be integrated into the building without the need for expensive cabling. The pendant is already equipped with pendant suspension and a ceiling plate. The WORKLIGHT family is a product family and is also available as a floor stand

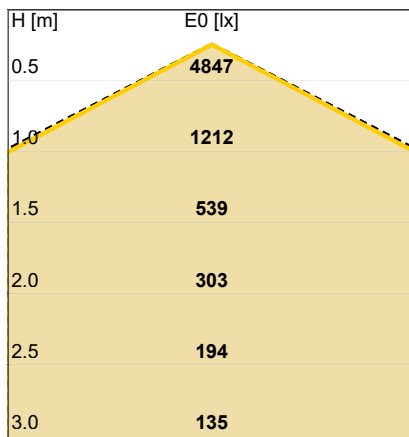

-- C0/C180 (half-peak divergence: 110.4°)
— C90/C270 (half-peak divergence: 109.6°)

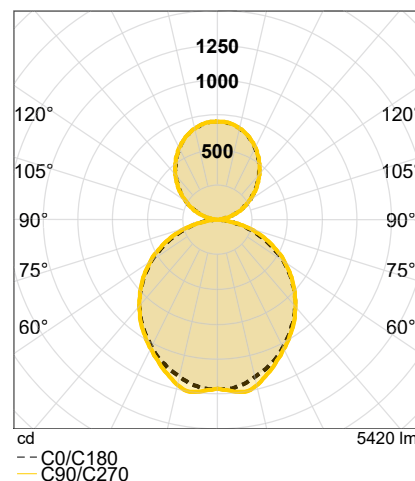

cd
-- C0/C180
— C90/C270

1002196 123

1002193 123

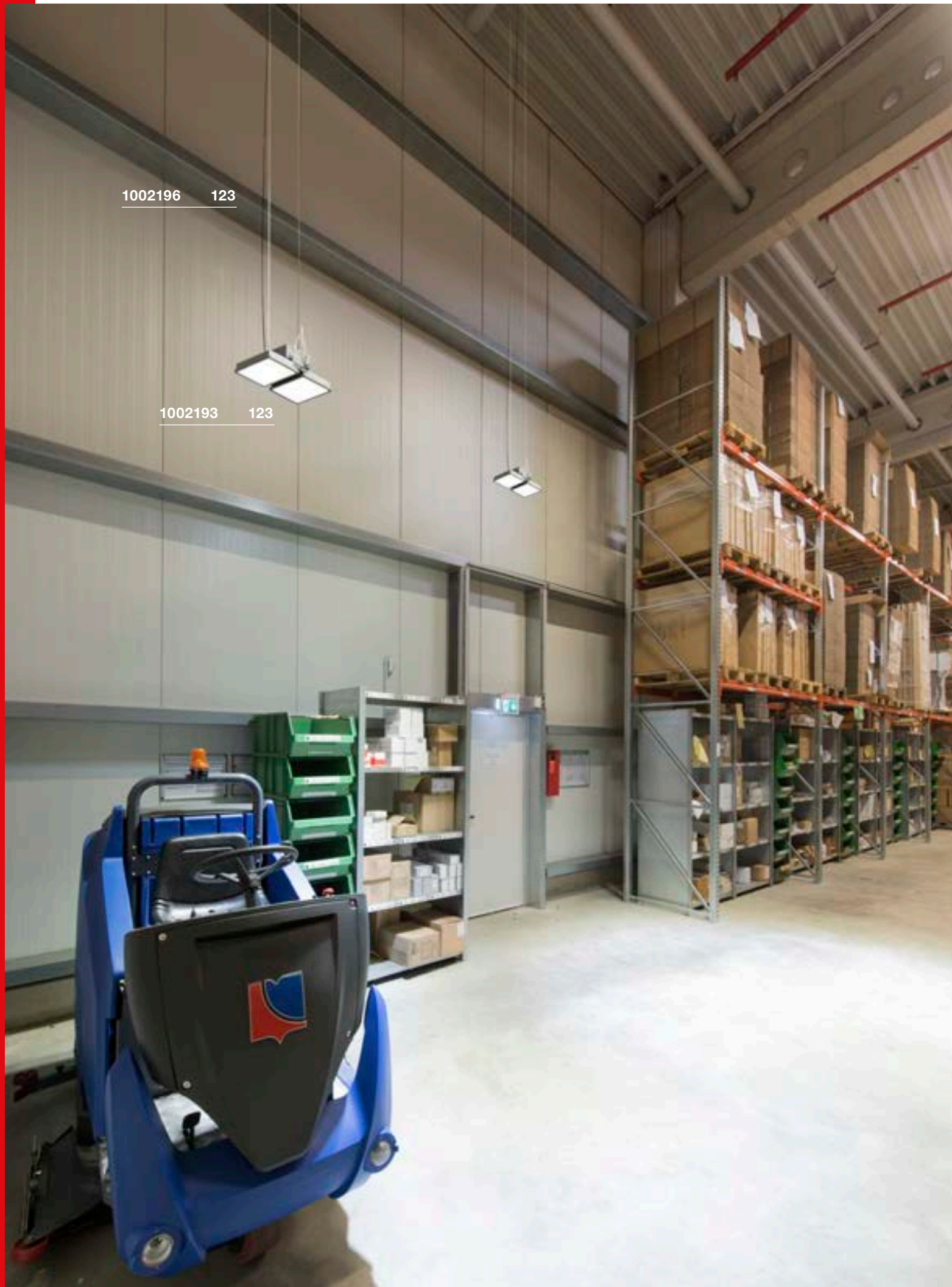



1002193 123

ALMINO
PD, double, UGR<19



A-A++ Range A++-E

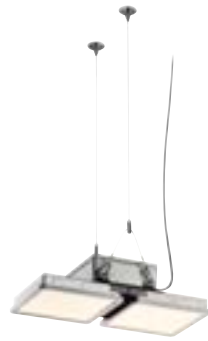

- Suitable for industrial areas, warehouse and logistical areas
- Efficient basic lighting with limited direct glare, UGR<19
- Extremely hard-wearing housing

Product details

220-240V ~50/60Hz | 600mA
Total consumption: 95W
Material: Steel / Polycarbonate (PC)

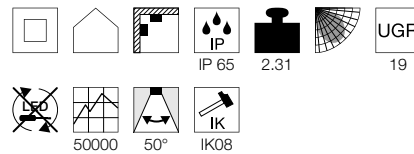

Dimensioned drawing

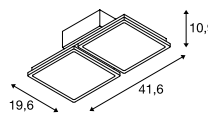

Note

Tilt range (when used with 1002197): 0-180°

Recommended accessories

■ Suspension set 3m

Item no. 1002196

■ Installation bracket

Item no. 1002197

ALMINO
PD, quad, UGR<19



A-A++ Range A++-E



- Suitable for industrial areas, warehouse and logistical areas
- Efficient basic lighting with limited direct glare, UGR<19
- Extremely hard-wearing housing

Product details

220-240V ~50/60Hz | 1200mA
Total consumption: 190W
Material: Steel / Polycarbonate (PC)

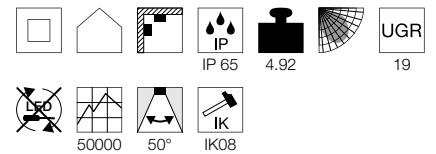

Dimensioned drawing

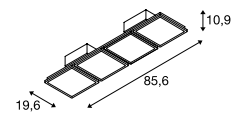

Recommended accessories

■ Suspension set 3m

Item no. 1002196

■ Installation bracket

Item no. 1002197

Variant	Item no.
12000lm 4000K CRI>80 ■ grey / white	1002193

Variant	Item no.
24000lm 4000K CRI>80 ■ grey / white	1002194

SUPROS 78
PD

897

A-A++ Range
A++-E

133121 124

Product details

220-240V ~50/60Hz | 250mA
 Total consumption: 12W
 Material: Aluminium
 Dimmable: Triac C, Triac L

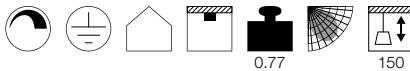

0.77

150



25000 60°

Dimensioned drawing

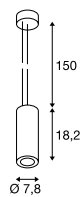

Recommended accessories

Lens, 20°

Item no. 116302



Lens, 40°

Item no. 116304



Variant	Item no.
700lm 3000K CRI>80	
■ black	133120
700lm 3000K CRI>80	
□ white	133121



133101 125



133100 125

SUPROS PD



A-A++ Range A++-E



Product details

220-240V ~50/60Hz | 750mA
 Total consumption: 31W
 Material: Aluminium

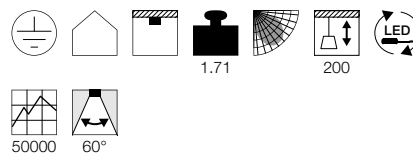

Dimensioned drawing

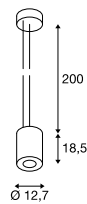

Recommended accessories

- Reflec or 20°
- Item no. 114102
- Reflec or 40°
- Item no. 114104

Variant	Item no.
2600lm 3000K CRI>80	
■ black	133100
2600lm 3000K CRI>80	
□ white	133101
2850lm 4000K CRI>80	
■ black	133110
2850lm 4000K CRI>80	
□ white	133111

SUPROS PD



A-A++ Range A++-E



Product details

220-240V ~50/60Hz | 950mA
 Total consumption: 36W
 Material: Aluminium

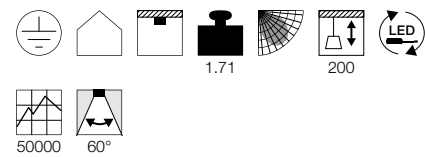

Dimensioned drawing

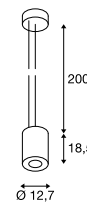

Recommended accessories

- Reflec or 20°
- Item no. 114102
- Reflec or 40°
- Item no. 114104

Variant	Item no.
3100lm 3000K CRI>80	
■ black	133140
3100lm 3000K CRI>80	
□ white	133141
3300lm 4000K CRI>80	
■ black	133150
3300lm 4000K CRI>80	
□ white	133151



1000259 127

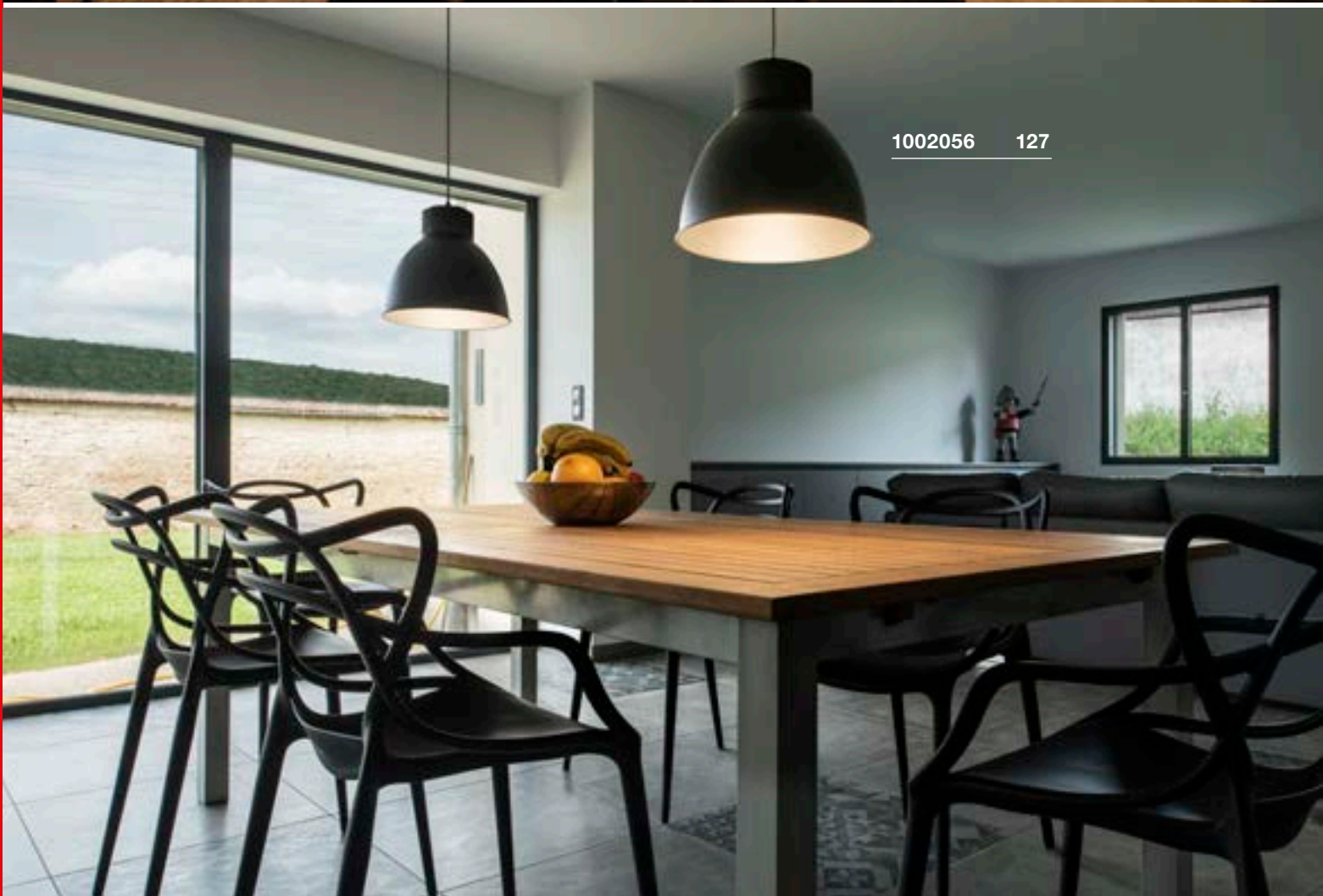

1002056 127

PARA DOME
PD, E27

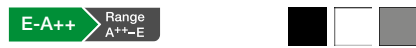

Product details

230V ~50Hz
Material: Aluminium



Dimensioned drawing

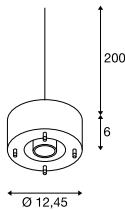

Note

Open cable end

Recommended lamp

LED E27 14.5W 200°
2700K 1521lm EEL=A+
15kWh/1000h
Item no. 560422



LED E27 17W 45°
3000K 1430lm EEL=A+
17kWh/1000h
Item no. 560473



Lamp details

max. 150W

Variant	Item no.
E27	
■ black	1002053
E27	
□ white	1002054
E27	
■ grey	1002055

PARA DOME
E27



Product details

Material: Aluminium
Product dimensions: Ø: 30.8 cm H: 20.6 cm

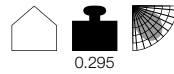

Variant	Item no.
■ black	1002056
□ white	1002057
■ grey	1002058

PARA DOME
E27



Product details

Material: Polycarbonate (PC)
Product dimensions: Ø: 31.5 cm H: 20.5 cm



Variant	Item no.
□ transparent	1002059

PARA 380
PD, E27

E-A++ Range A++-E

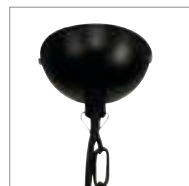

Product details

230V ~50Hz
Material: Aluminium

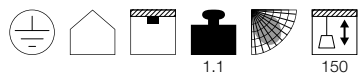

Dimensioned drawing

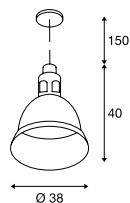

Recommended lamp

LED E27 14.5W 200°
2700K 1521lm EEL=A+
15kWh/1000h
Item no. 560422



LED E27 18.5W 38°
4000K 1280lm EEL=A+
19kWh/1000h
Item no. 551944



Lamp details

160W HME-SB

Variant	Item no.
E27 HME-SB	
■ grey	165350
E27 HME-SB	
■ red	165356
E27 HME-SB	
■ aluminium	165358
E27 HME-SB	
■ black	165359





165100 129



165100 129

PARA DOME
PD, E27

E-A++ Range A++-E



- Wide-open lamp shade

Product details

230V ~50Hz
Material: Aluminium / Polycarbonate (PC)

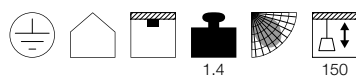

1.4 150

Dimensioned drawing

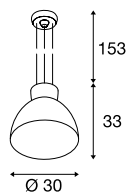

Recommended accessories

Reflec or cover
Item no. 165160

Recommended lamp

LED E27 14.5W 200°
2700K 1521lm EEL=A+
15kWh/1000h
Item no. 560422

LED E27 15W 240°
3000K 1521lm EEL=A+
15kWh/1000h
Item no. 1001033

Lamp details

max. 150W

Variant	Item no.
E27	
■ anthracite	165100

PARA MULTI
PD, DLMI

A-A++ Range A++-E

LED INSIDE



Product details

220-240V ~50/60Hz
Total consumption: 18W
Material: Steel / Acrylic



3.6 300

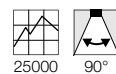

25000 90°

Dimensioned drawing

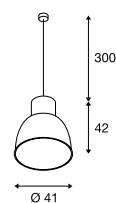

Variant	Item no.
2040lm 4000K CRI>80	
■ grey / matt transparent	165221
1940lm 3000K CRI>80	
■ grey / matt transparent	165222

PARA FLAC
PD/CL

A-A++ Range
A++-E



• High light output: >100lm/W

Product details

220-240V ~50/60Hz | 2400mA
Material: Aluminium / Polycarbonate (PC)

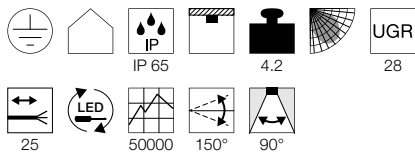

Dimensioned drawing

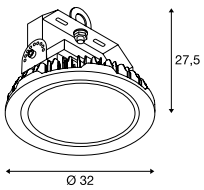

Note

Product supplied without chain and can be suspended using normal commercial chains. Open cable end.

Recommended accessories

■ IP68 connection box, 3-pole
Item no. 228730

■ Reflec or
Item no. 1000918

□ Refractor
Item no. 1001691

□ Refractor cover
Item no. 1001692



Variant	Item no.
12800lm 4000K CRI>80 104W	
■ black	1000827
19200lm 4000K CRI>80 150W	
■ black	1000828

1000828 + 1000918 130





1003107 + 1001691 + 1001692 131

PARA FLAC
PD/CL, DALI

A-A++ Range A++-E

LED INSIDE

NEW VARIANT



Product details

220-240V ~50/60Hz | 1600mA
Total consumption: 104W
Material: Aluminium / Polycarbonate (PC)
Dimmable: Dali

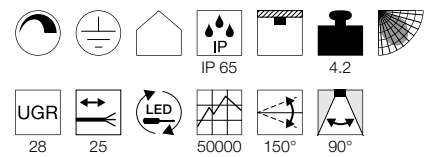

Dimensioned drawing

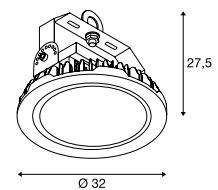

Note

Product supplied without chain and can be suspended using normal commercial chains. Open cable end.

Recommended accessories

■ IP68 connection box, 3-pole

Item no. 228730

■ Reflec or

Item no. 1000918

□ Refractor

Item no. 1001691

□ Refractor cover

Item no. 1001692

Variant

Item no.

12800lm | 4000K | CRI>80

■ black

1003107

SURPRISINGLY VERSATILE.

WALL LIGHTS PRODUCE
INDIVIDUAL SPOTS OF LIGHT.

An eye-catcher for the wall – a real highlight for the room: Wall lights are an ideal way of setting light spots in a space-saving way. With the wide range of designs and colours, there is something for every taste.





1002928 157



1003035 + 1001453 193 + 192



WALL LIGHTS

 137	 137	 139	 139	 140	 140	 142	 143
 144	 145	 145	 145	 146	 147	 148	 148
 149	 149	 150	 151	 151	 152	 153	 153
 153	 154	 155	 155	 156	 156	 157	 157
 158	 158	 159	 159	 161	 162	 162	 163
 163	 164	 164	 164	 166	 167	 167	 167
 168	 168	 169	 169	 170	 171	 171	 171

 172	 172	 173	 173	 174	 174	 175	 175
 176	 176	 178	 178	 179	 180	 180	 180
 183	 183	 183	 184	 184	 185	 186	 186
 188	 189	 190	 191	 192	 192	 193	 194
 194	 194	 195	 196	 197	 198	 199	 199
 199	 200	 200	 202	 202	 202	 204	 204
 205	 206	 206	 208	 208	 210	 210	 211
 211	 212	 212	 213	 213	 214	 215	 215
 216	 216	 219	 220	 220	 221	 223	 223
 223	 224	 224	 225	 225	 227	 227	 228
 228	 229						

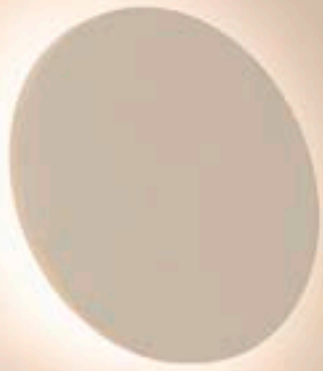

148091 137





148091 137



148019 137

PLASTRA
WL

893

A-A++ Range A++-E



- Can be individually designed with colours, stickers and more

Product details

100-240V ~50/60Hz | 12V DC
Total consumption: 7.4W
Material: Plaster / Steel



Dimensioned drawing

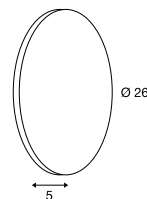

PLASTRA
WL, Square

893

A-A++ Range A++-E



- Can be individually designed with colours, stickers and more

Product details

100-240V ~50/60Hz | 12V DC
Total consumption: 11W
Material: Plaster / Steel

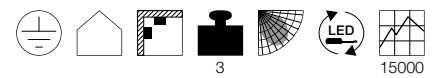

Dimensioned drawing

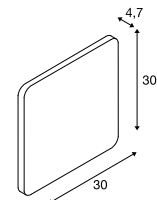

Variant	Item no.
400lm 3000K CRI>80 □ white	148091

Variant	Item no.
400lm 3000K CRI>80 □ white	148019

1000746 139

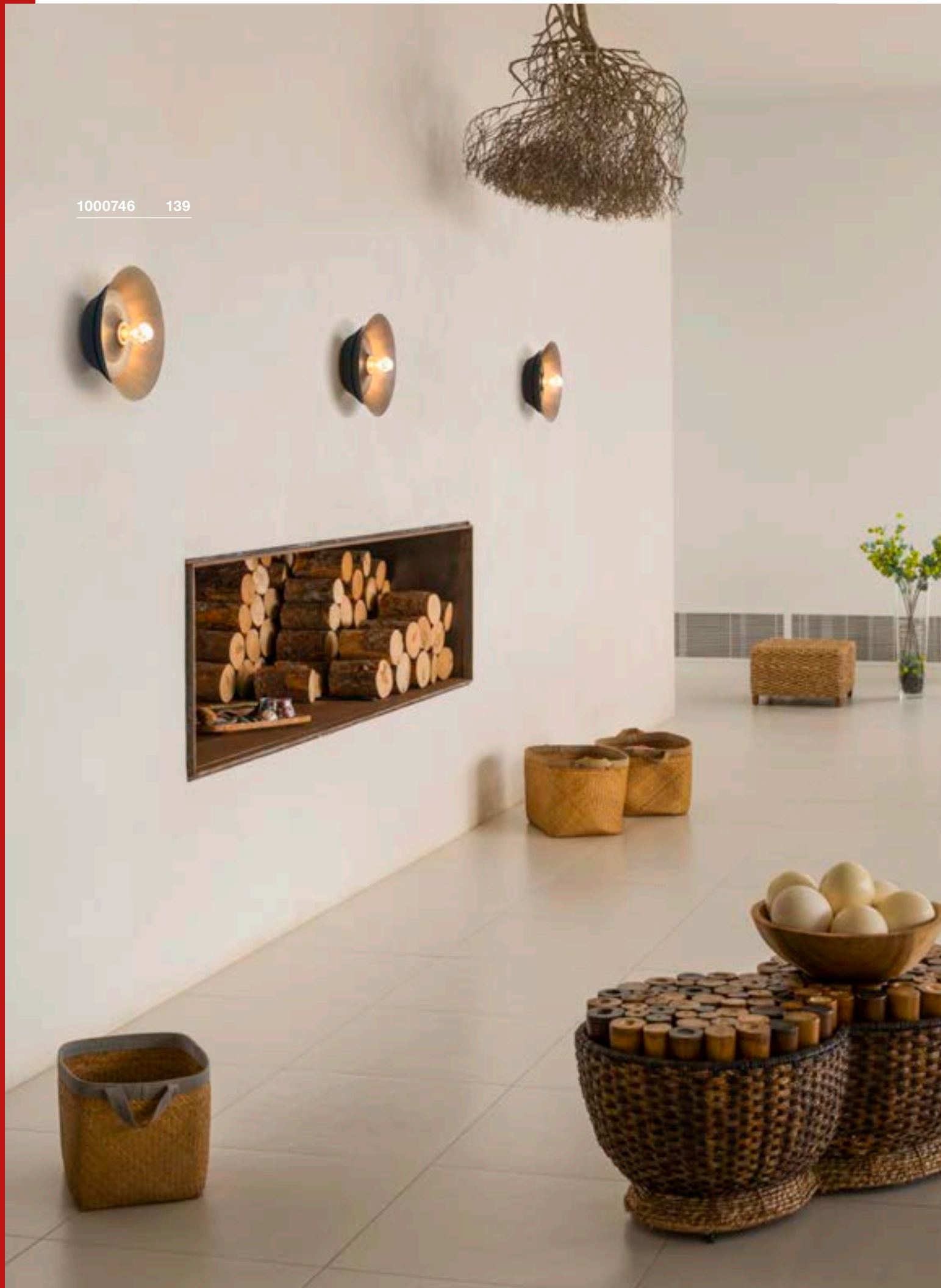



1000745 139

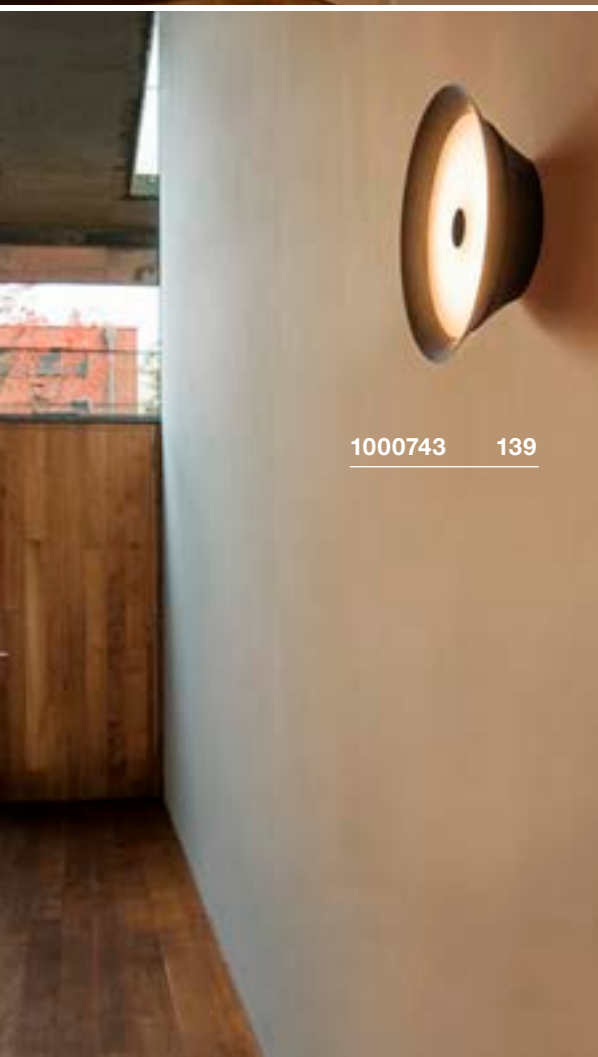

1000743 139

BATO 35
CW, TRIAC



A-A++ Range A++-E

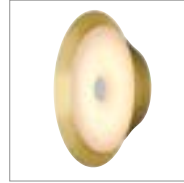

Product details

220-240V ~50/60Hz | 700mA
Total consumption: 15W
Material: Aluminium / Polymethylacrylate (PMMA)
Dimmable: Triac C

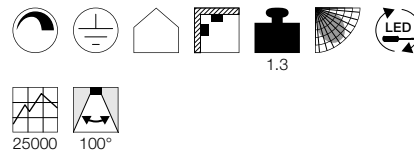

Dimensioned drawing

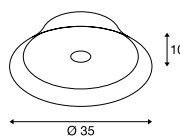

BATO 35
CW, E27



E-A++ Range A++-E

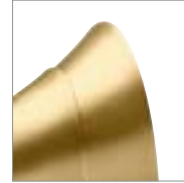

Product details

220-240V ~50/60Hz
Material: Aluminium / Steel

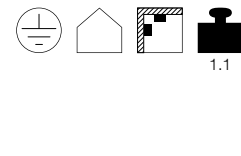

Dimensioned drawing

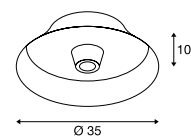

Recommended lamp

LED E27 7.1W 330°
2700K 806lm EEL=A+
8kWh/1000h
Item no. 1001756



LED E27 7W 180°
2700K 630lm EEL=A+
8kWh/1000h
Item no. 1001357



Lamp details

max. 60W

Variant	Item no.
850lm 2700K CRI>80	
■ black	1000743
1050lm 2500K CRI>80	
■ matt brass	1000745

Variant	Item no.
E27	
■ black	1000746
E27	
■ brass	1000748

ONE 40
WL, DALI



A-A++ Range A++-E



- Switchable light colour

Product details

220-240V ~50/60Hz | 350mA
 Total consumption: 14W
 Material: Aluminium / Steel
 Dimmable: Dali
 Product dimensions: Ø: 40 cm D: 7.5 cm

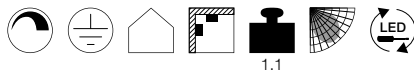

1.1



30000

ONE 60
WL, DALI



A-A++ Range A++-E



- Switchable light colour

Product details

220-240V ~50/60H | 600mA
 Total consumption: 25W
 Material: Aluminium / Steel
 Dimmable: Dali
 Product dimensions: Ø: 60 cm D: 8 cm

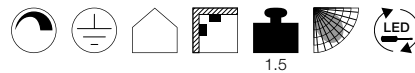

1.5



30000

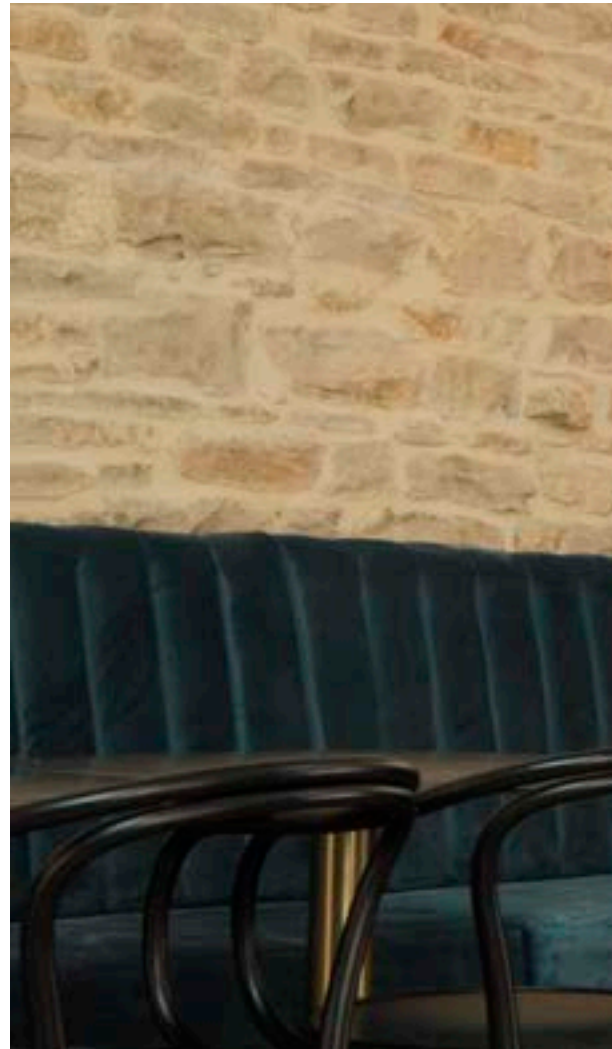

Variant	Item no.
720/770lm 3000/4000K CRI>80	
■ matt black / black	1002915
720/770lm 3000/4000K CRI>80	
□ matt white / white	1002917

Variant	Item no.
1400/1500lm 3000/4000K CRI>80	
■ matt black / black	1002918
1400/1500lm 3000/4000K CRI>80	
□ matt white / white	1002919



1002919 140

BRENDA
WL



A-A++ Range A++-E

LED INSIDE



reddot award 2018 winner



- Adjustable spot
- Light sources switchable together or separately
- Luminaire can also be switched externally

Product details

220-240V ~50/60Hz | 500mA
Total consumption: 14W
Material: Aluminium / Glass
Dimmable: Triac C, Triac L

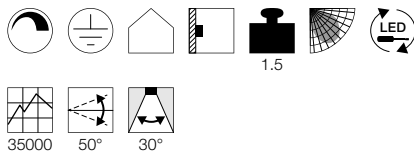

Dimensioned drawing

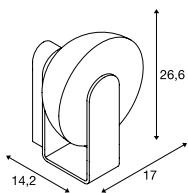

reddot award 2018 winner

DESIGNED BY
Johannes Tomm

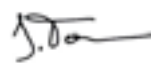

Variant	Item no.
Indirect: 880lm 3000K CRI>80 Spot: 80lm 3000K CRI>80 ■ white / matt grey	149431



149431 142



155752 143



155752 143

LISENNE
WL, E27
 890
E-A++ Range
A++-E

- Basalt and smoked glass

Product details

220-240V ~50/60Hz
Material: Basalt / Glass

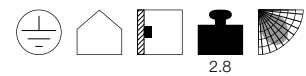

Dimensioned drawing

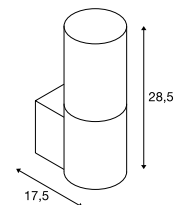

Recommended lamp

LED E27 7,1W 330°
2700K 806lm EEL=A+
8kWh/1000h
Item no. 1001756



Lamp details

max. 23W
Ø: 5.9 cm max. L: 15 cm max.

Variant	Item no.
E27 ■ grey / brown	155752

ANDREAS
WL, QT-DE12D-A+ Range
A++-E

NEW



Product details

220-240V ~50/60Hz
Material: Aluminium / Steel



0.56

100°

Maßzeichnung

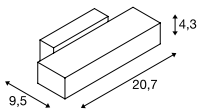

Recommended lamp

R7s 118mm 10.5W 330°
3000K 1050lm EEL=A+
11kWh/1000h
Item no. 560352



LED R7s 118mm 14W
3000K 2000lm EEL=A++
14kWh/1000h
Item no. 1002135



Lamp details

max. 80W

Variant	Item no.
R7s 118mm □ matt white / white	1002925
R7s 118mm ■ matt grey / grey	1002926
R7s 118mm ■ matt black / black	1002927

1002926 144



1002993 145

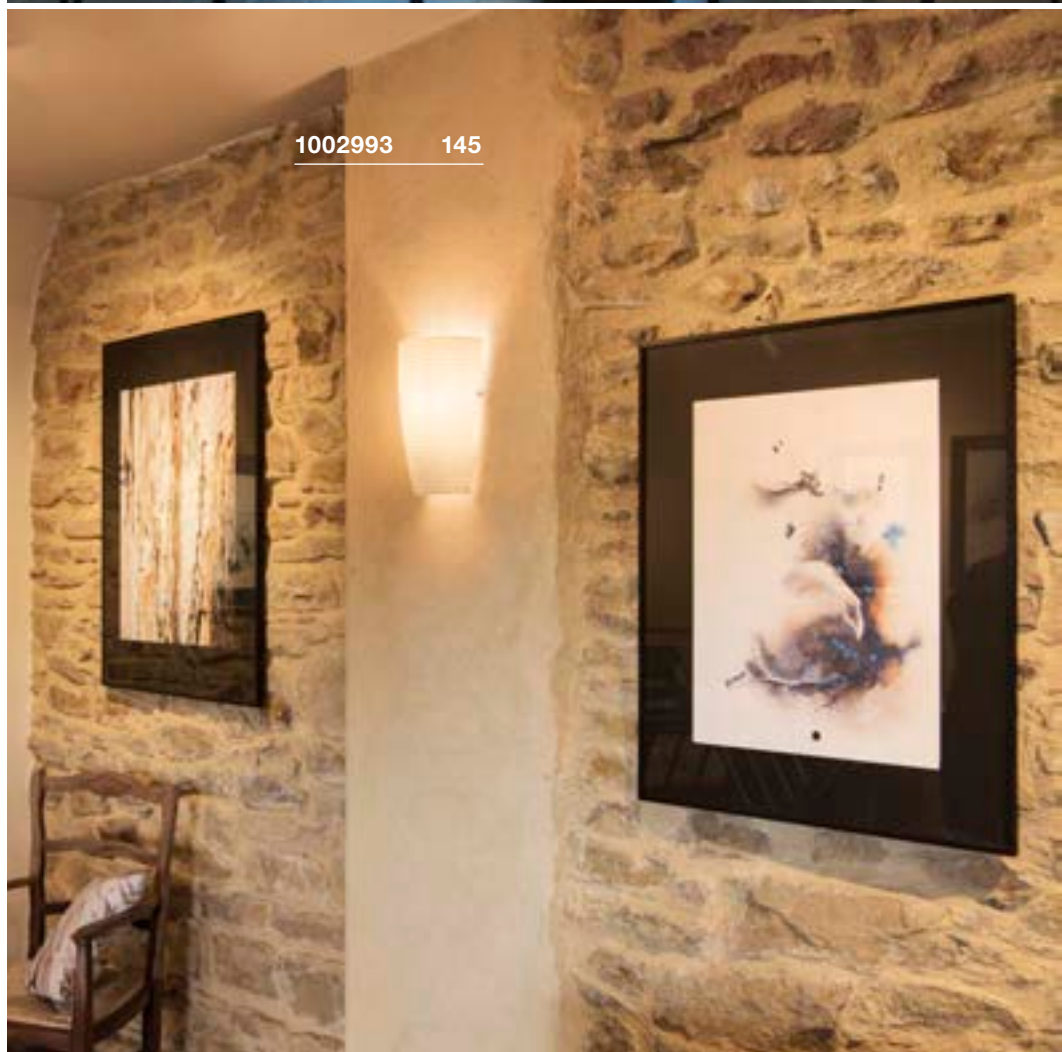

DENA 30
WL, E14

E-A++ Range A++-E

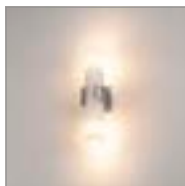

PURISA
WL, E27

E-A++ Range A++-E



BASKET
WL, E27

E-A++ Range A++-E



• High-quality, frosted glass

Product details

230V ~50Hz
Material: Aluminium / Glass

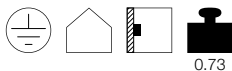

0.73

Dimensioned drawing

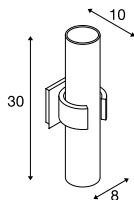

Product details

220-240V ~50/60Hz
Material: Steel / Glass

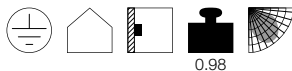

0.98

Dimensioned drawing

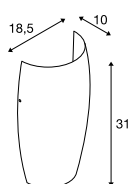

Product details

230V ~50Hz
Material: Aluminium / Glass

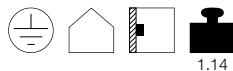

1.14

Dimensioned drawing

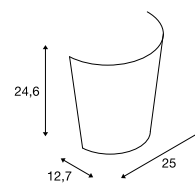

Recommended lamp

E14 4W
2700K 250lm EEL=A+
4kWh/1000h
Item no. 560222



Lamp details

2x max. 40W C35
Ø: 5 cm max. L: 9.6 cm max.

Variant	Item no.
E14 C35	
□ matt aluminium	147529

Recommended lamp

LED E27 9.1W 240°
2700K 760lm EEL=A+
10kWh/1000h
Item no. 560402



LED E27 9.5W 240°
2200-6700K 806lm EEL=A+
10kWh/1000h
Item no. 1001917



Lamp details

max. 40W
Ø: 8 cm max. L: 15 cm max.

Variant	Item no.
E27	
□ shiny white / opaque	1002993

Recommended lamp

LED E27 9.1W 240°
2700K 760lm EEL=A+
10kWh/1000h
Item no. 560402



LED E27 9.5W 240°
2200-6700K 806lm EEL=A+
10kWh/1000h
Item no. 1001917



Lamp details

max. 60W
Ø: 5.2 cm max. L: 15.2 cm max.

Variant	Item no.
E27	
□ white	151591

FITU
WL, E27



E-A++ Range A++-E



Product details

220-240V ~50/60Hz
Material: Aluminium / Steel

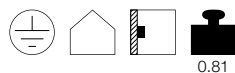

0.81

Dimensioned drawing

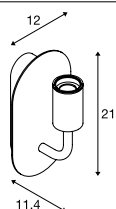

Recommended lamp

E27 5W 330°
2000K 500lm EEL=A+
5kWh/1000h
Item no. 560741



LED E27 7W 330°
2700K 806lm EEL=A+
8kWh/1000h
Item no. 1001038



Lamp details

max. 24W

Variant	Item no.
E27	
white	1002147
black	1002148
E27	
gold	1002149

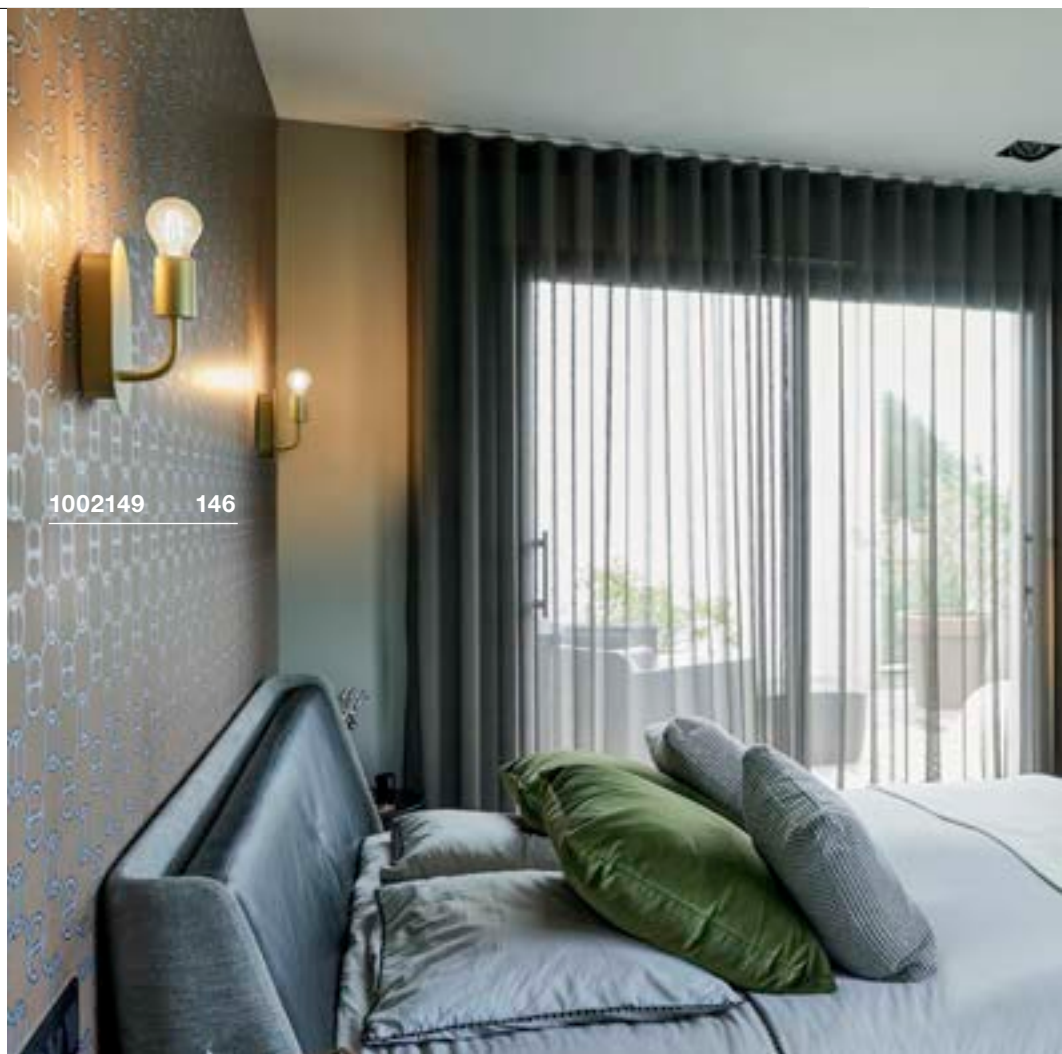

1002149 146

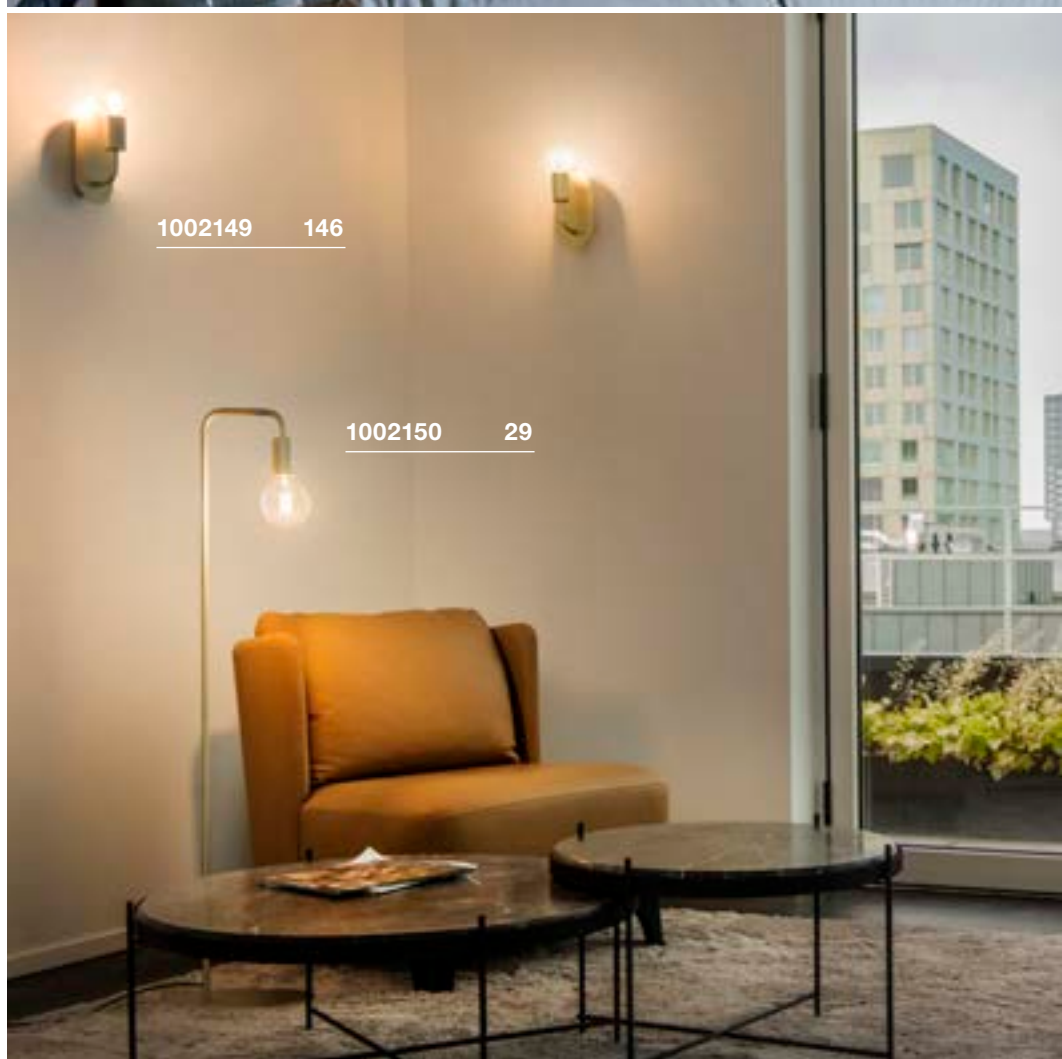

1002149 146

1002150 29

SOPRANA OVAL
WL, E27 896E-A++ Range
A++-E

155861 147

Product details

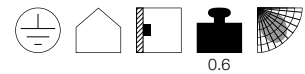
230V ~50Hz
Material: Steel / Textile

Dimensioned drawing

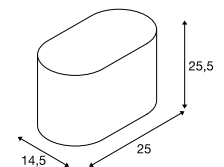

Recommended lamp

LED E27 7W 280°
2700K 790lm EEL=A++
7kWh/1000h

Item no. 1002124

LED E27 9W 240°
2700-6500K 806lm EEL=A+
9kWh/1000h

Item no. 1001916



Lamp details

max. 60W
L: 13 cm max.

Variant	Item no.
E27 □ white	155861

FENDA
WL, basic, E27



E-A++ Range A++-E



FENDA
Half-shade



- Individually configurable by selecting a suitable lamp base

Product details

230V ~50/60Hz
Material: Steel / Plastic

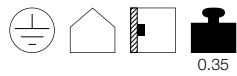

Dimensioned drawing

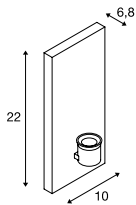

Product details

Material: Textile / Steel



Dimensioned drawing

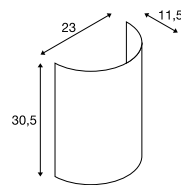

Note

max. 40W

Recommended lamp

LED E27 9.1W 240°
2700K 760lm EEL=A+
10kWh/1000h
Item no. 560402



LED E27 9W 240°
2700-6500K 806lm EEL=A+
9kWh/1000h
Item no. 1001916



Lamp details

max. 40W
Ø: 5 cm max. L: 20 cm max.

Variant	Item no.
E27	
white	1001272

Variant	Item no.
black	1001273
black / copper	1001274
white	1001275
beige	1001276





155340 149



155643 149

LASSON
WL, E27



E-A++ Range A++-E

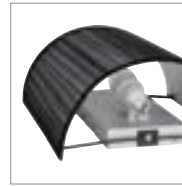
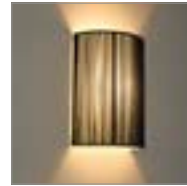

Product details

230V ~50Hz
Material: Textile / Steel

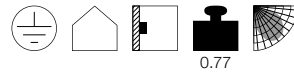

Dimensioned drawing

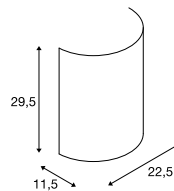

Recommended lamp

LED E27 7W 280°
2700K 790lm EEL=A++
7kWh/1000h
Item no. 1002124



LED E27 7W 280°
2200-2700K 830lm EEL=A++
7kWh/1000h
Item no. 1002126



Lamp details

max. 40W
Ø: 5 cm max. L: 20 cm max.

Variant	Item no.
E27	
■ black	155340

SOPRANA
WL, E27



E-A++ Range A++-E



Product details

230V ~50Hz
Material: Textile / Steel

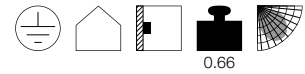

Dimensioned drawing

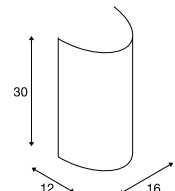

Recommended lamp

LED E27 9.1W 240°
2700K 760lm EEL=A+
10kWh/1000h
Item no. 560402



LED E27 9W 240°
2700-6500K 806lm EEL=A+
9kWh/1000h
Item no. 1001916



Lamp details

max. 40W
Ø: 6.6 cm max. L: 17.3 cm max.

Variant	Item no.
E27	
■ beige	155643

MANA
WL, basic, TRIAC



A-A++ Range A++-E



- Premium LED with CRI>90
- Dim to Warm

Product details

220-240V ~50/60Hz | 350mA
Total consumption: 8W
Material: Aluminium / Steel
Dimmable: Triac C

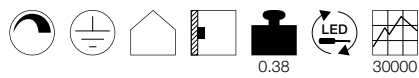

Dimensioned drawing

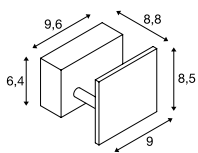

1000613 + 1000618 150 + 151

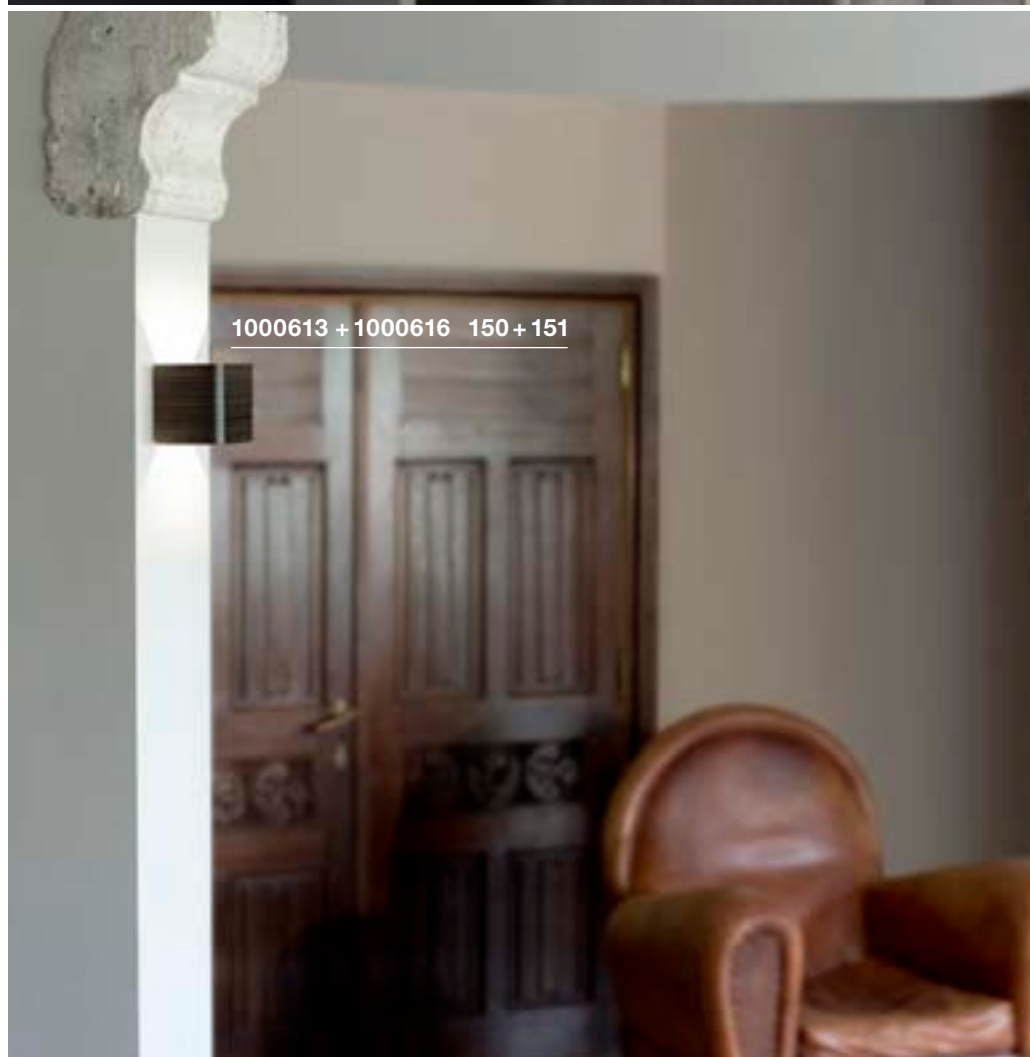

1000613 + 1000616 150 + 151

Variant	Item no.
320lm 2000-3000K CRI>90 □ white	1000613



MANA
Shade



MANA
Shade



- Can be individually designed with colours, stickers and more

Product details

Material: Plaster / Steel



Dimensioned drawing

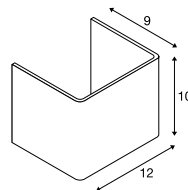

Note

Only suitable for 1000613

Dimensioned drawing

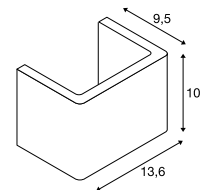

Note

Only suitable for 1000613

Variant	Item no.
Wood 0.11 kg	
■ grey / brown	1000616
Aluminium 0.29 kg	
□ white	1000618
Aluminium 0.29 kg	
□ aluminium	1000619

Variant	Item no.
□ white	1000824

MANA
WL, basic, TRIAC



A-A++ Range
A++-E



- Premium LED with CRI>90
- Dim to Warm

Product details

220-240V ~50/60Hz | 350mA
Total consumption: 15W
Material: Aluminium / Steel
Dimmable: Triac C

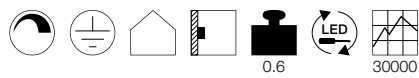

Dimensioned drawing

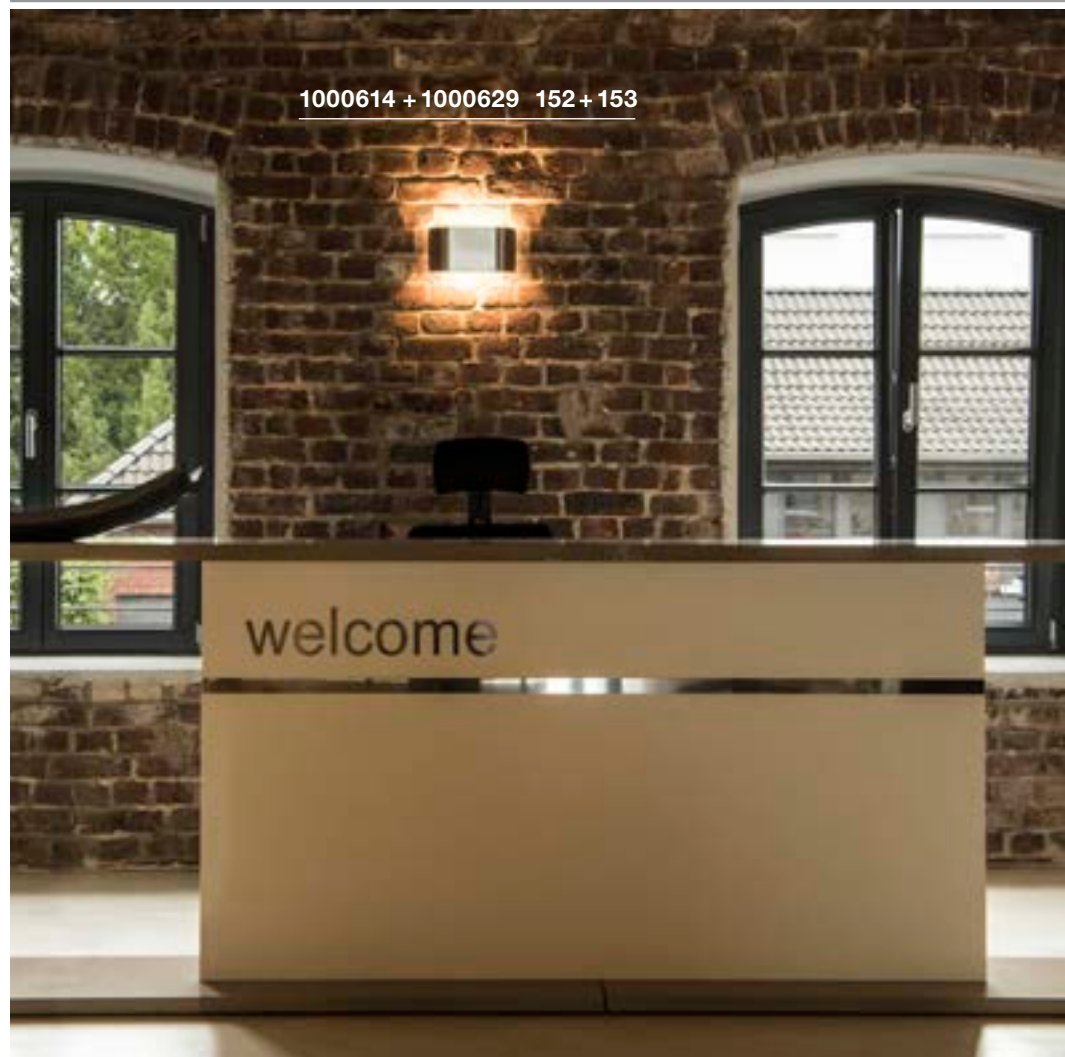
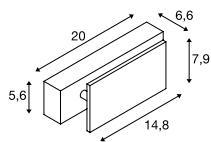

1000614 + 1000629 152 + 153

Variant	Item no.
700lm 2000-3000K CRI>90	
□ white	1000614

MANA
Shade



MANA
Shade

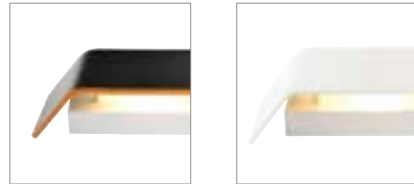

MANA
Shade

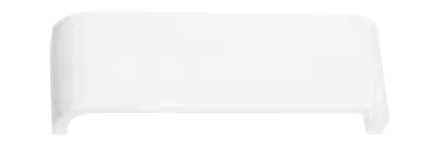

- Can be individually designed with colours, stickers and more

Product details

Material: Plaster / Steel



Dimensioned drawing

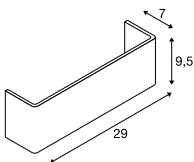

Note

Only suitable for 1000614/1000615



Dimensioned drawing

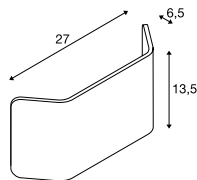

Note

Only suitable for 1000614/1000615



0.93

Dimensioned drawing

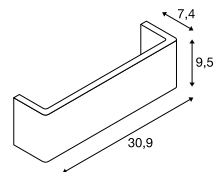

Note

Only suitable for 1000614/1000615

Variant	Item no.
Wood 0.16 kg	
grey / brown	1000621
Aluminium 0.39 kg	
white	1000623
Aluminium 0.39 kg	
aluminium	1000624

Variant	Item no.
Wood 0.2 kg	
grey / brown	1000626
Aluminium 0.47 kg	
white	1000628
Aluminium 0.47 kg	
aluminium	1000629

Variant	Item no.
white	1000825

PLASTRA
WL, rectangular, QT-DE12



893

D-A+ Range A++-E

NEW



- Can be individually designed with colours, stickers and more

148018 155

Product details

220-240V ~50/60Hz
Material: Plaster / Steel

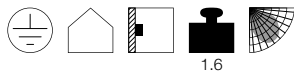

1.6

Dimensioned drawing

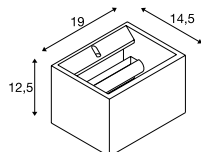

Recommended lamp

R7s 118mm 10.5W 330°
3000K 1050lm EEL=A+
11kWh/1000h
Item no. 560352



LED R7s 118mm 14W
3000K 2000lm EEL=A++
14kWh/1000h
Item no. 1002135



Lamp details

max. 20W

Variant	Item no.
R7s 118mm □ white	1002238

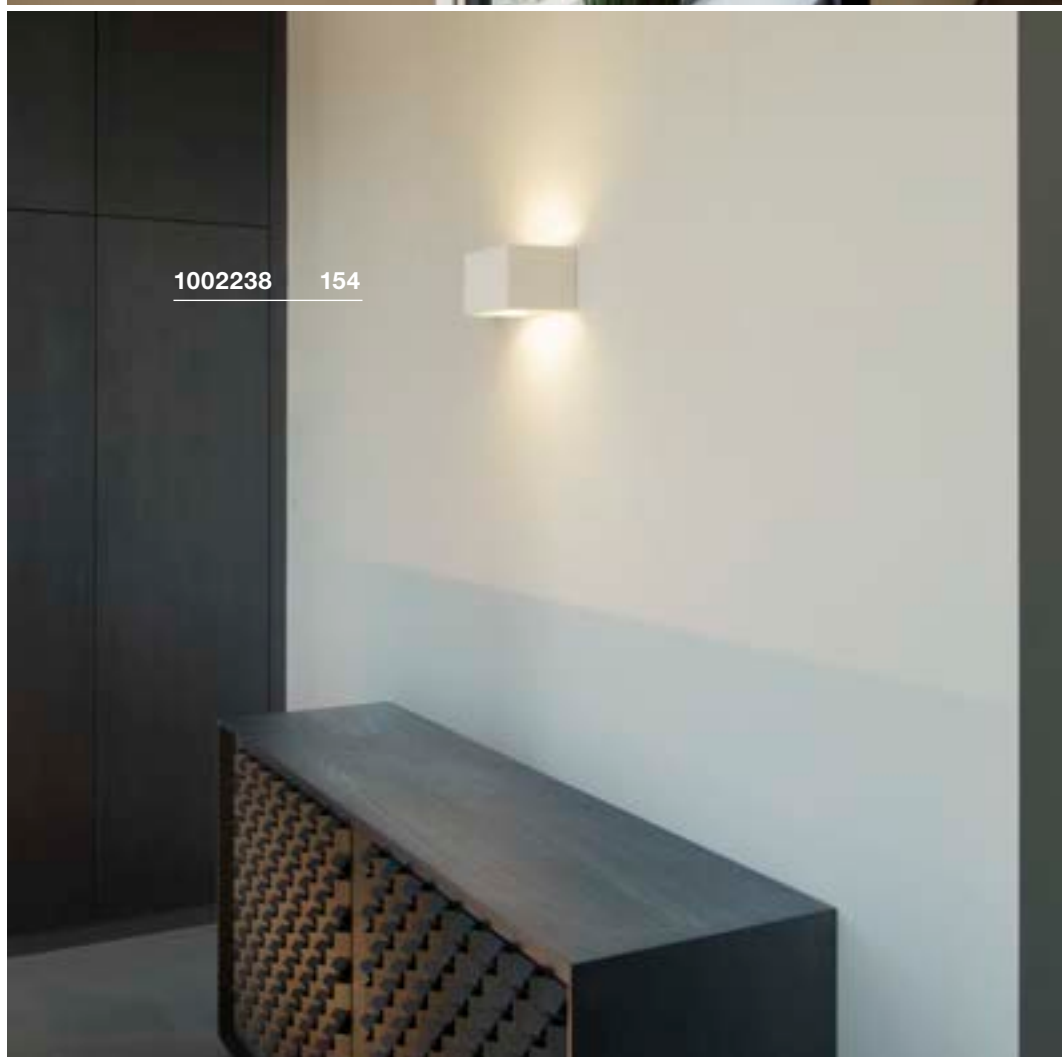
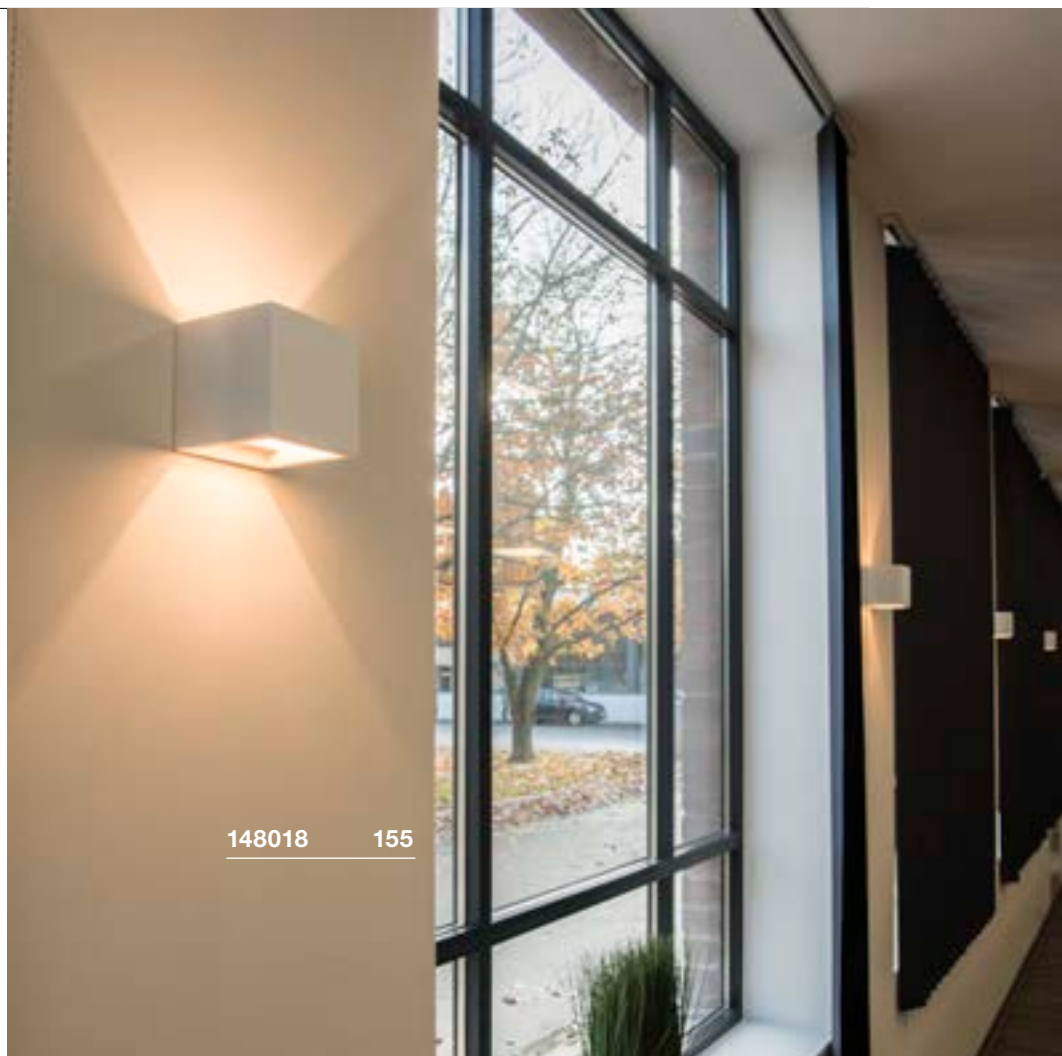

1002238 154



1000910 155



1000911 155

SOLID CUBE
WL, QT14

D-A+ Range A++-E

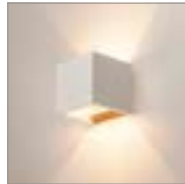
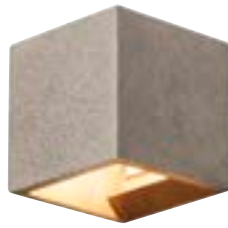

Product details

230V ~50Hz
Material: Concrete

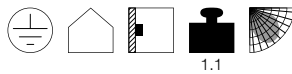

1.1

Dimensioned drawing

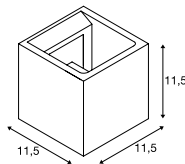

PLASTRA
WL, Cube, QT14

893

D-A+ Range A++-E

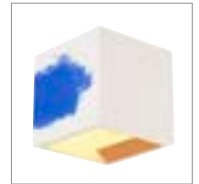
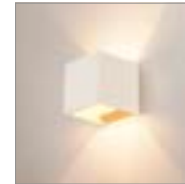
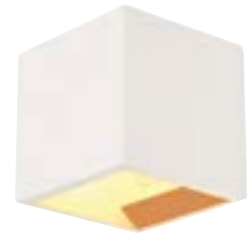

- Can be individually designed with colours, stickers and more

Product details

230V ~50Hz
Material: Plaster / Steel

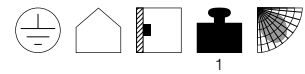

1

Dimensioned drawing

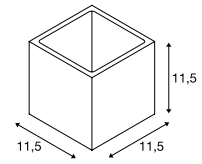

Recommended lamp

G9 2.5W
2700K 180lm EEL=A+
3kWh/1000h
Item no. 560302



Lamp details

max. 25W QT14

Variant	Item no.
G9 QT14	
grey	1000910
G9 QT14	
black	1000911

Recommended lamp

LED G9 3.5W
2800K 300lm EEL=A+
4kWh/1000h
Item no. 1002131



Lamp details

max. 42W QT14

Variant	Item no.
G9 QT14	
white	148018

LOGS IN
WL



A-A++ Range
A++-E



- Premium LED with CRI>90
- Dim to Warm

Product details

220-240V ~50/60Hz | 250mA
Total consumption: 12W
Material: Aluminium
Dimmable: Triac C, Triac L

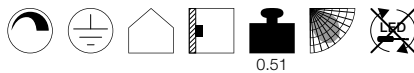

0.51



30000

Dimensioned drawing

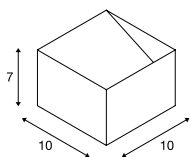

LOGS IN
WL



A-A++ Range
A++-E



Product details

100-240V ~50/60Hz | 500mA
Total consumption: 6.9W
Material: Aluminium



0.47

30000

Dimensioned drawing

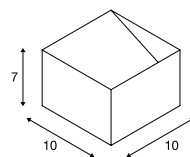

1000640 156



151320 156



Variant	Item no.
290lm 2000-3000K CRI>90	
■ black / gold	1000638
490lm 2000-3000K CRI>90	
□ white	1000639
490lm 2000-3000K CRI>90	
▒ aluminium / white	1000640

Variant	Item no.
390lm 3000K CRI>90	
■ black / gold	151320
440lm 3000K CRI>90	
□ white	151321
440lm 3000K CRI>90	
▒ aluminium / white	151325



1002843 157



1002928 157

LOGS IN L
WL



A-A++ Range A++-E



LED INSIDE

NEW

Dim to Warm



- Premium LED with CRI>90
- Dim to Warm

Product details

220-240V ~50/60Hz | 500mA
Total consumption: 19W
Material: Aluminium
Dimmable: Triac C, Triac L

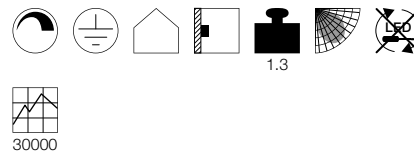

Dimensioned drawing

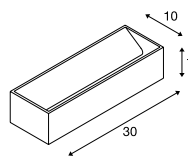

Variant	Item no.
1500lm 2000-3000K CRI>90	
■ black / gold	1002930
1500lm 2000-3000K CRI>90	
□ white	1002929
1100lm 2000-3000K CRI>90	
▒ aluminium / white	1002928

LOGS IN L
WL, TRIAC



A-A++ Range A++-E



LED INSIDE

NEW

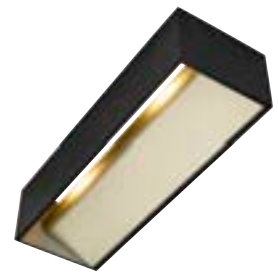

- Premium LED with CRI>90

Product details

220-240V ~50/60Hz | 500mA
Total consumption: 17W
Material: Aluminium
Dimmable: Triac C, Triac L

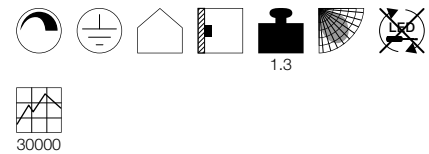

Dimensioned drawing

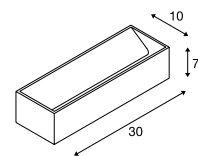

Variant	Item no.
1100lm 3000K CRI>90	
■ black / gold	1002842
1400lm 3000K CRI>90	
□ white	1002844
1400lm 3000K CRI>90	
▒ aluminium / white	1002843

QUAD UP/DOWN 12 WL



A-A++ Range A++-E



QUAD UP/DOWN 15 WL



A-A++ Range A++-E

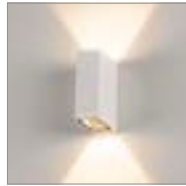

Product details

200-240V ~50/60Hz | 700mA
 Total consumption: 6.8W
 Material: Aluminium / Glass

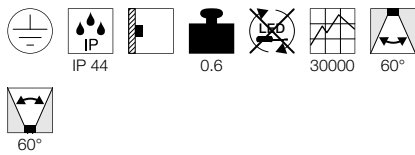

Dimensioned drawing

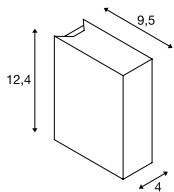

Product details

100-277V ~50/60Hz | 350mA
 Total consumption: 8.6W
 Material: Aluminium / Glass

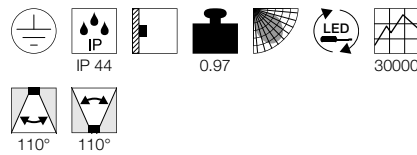

Dimensioned drawing

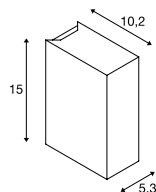

Variant	Item no.
175lm 3000K CRI>80 □ white	232471
140lm 3000K CRI>80 ■ anthracite	232475

Variant	Item no.
Up: 290lm 3000K CRI>80 Down: 290lm 3000K CRI>80 □ white	232441
Up: 260lm 3000K CRI>80 Down: 260lm 3000K CRI>80 ■ anthracite	232445

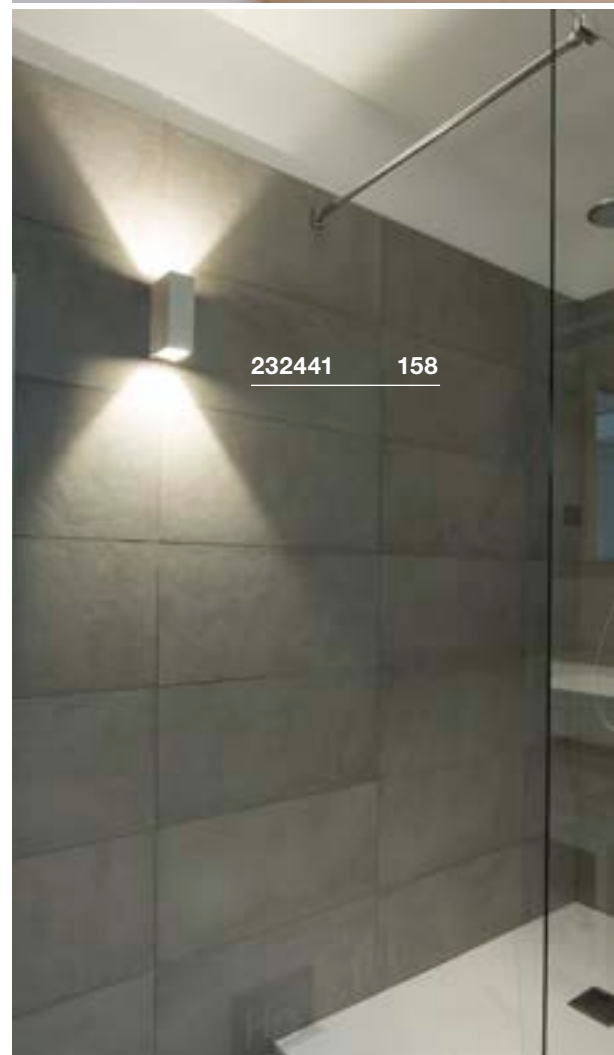



148010 159



148015 159

PLASTRA
WL, slot, E14



E-A++ Range A++-E

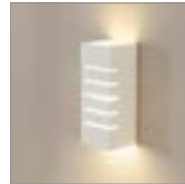

- Can be individually designed with colours, stickers and more

Product details

230V ~50Hz
Material: Plaster / Steel

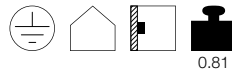

0.81

Dimensioned drawing

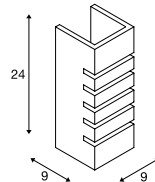

Recommended lamp

LED E14 6.5W 280°
3000K 480lm EEL=A+
7kWh/1000h
Item no. 560372



Lamp details

max. 40W C35

Variant	Item no.
E14 C35 □ white	148010

PLASTRA
WL, QPAR51



E-A++ Range A++-E



- Can be individually designed with colours, stickers and more

Product details

220-240V ~50/60Hz
Material: Plaster / Steel

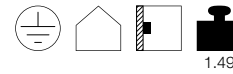

1.49

Dimensioned drawing

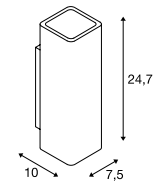

Recommended lamp

LED GU10 7.2W 36°
3000K 520lm EEL=A+
8kWh/1000h
Item no. 1001562



LED GU10 7.2W 36°
4000K 540lm EEL=A+
8kWh/1000h
Item no. 1001565



Lamp details

2x max. 35W QPAR51

Variant	Item no.
GU10 QPAR51 □ white	148015

1000327 161





1000330 + 1000327 161

THEO UP/DOWN
WL, QPAR51



E-A++ Range A++-E



Product details

230V ~50Hz
Material: Aluminium

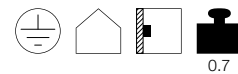

Dimensioned drawing

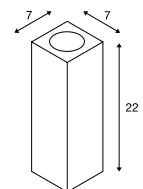

Recommended lamp

LED GU10 7.2W 36°
4000K 540lm EEL=A+
8kWh/1000h
Item no. 1001566



LED GU10 5.5W 38°
2700K 400lm EEL=A+
6kWh/1000h
Item no. 1001030



Lamp details

2x max. 50W QPAR51

Variant	Item no.
GU10 QPAR51	
white	1000327
GU10 QPAR51	
grey	1000328
GU10 QPAR51	
matt aluminium	1000329
GU10 QPAR51	
anthracite	1000330

CHROMBO
WL

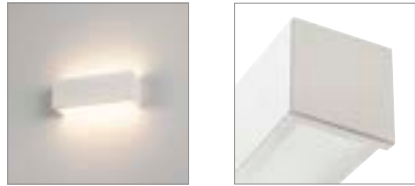

TANI
WL, QT-DE12

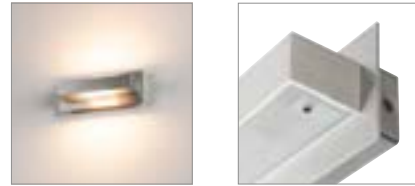

Product details

220-240V ~50/60Hz
Total consumption: 9.7W
Material: Steel / Glass
Dimmable: Triac C, Triac L

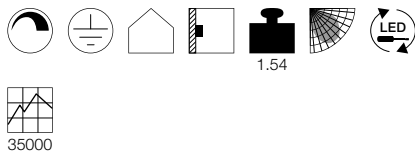

Dimensioned drawing

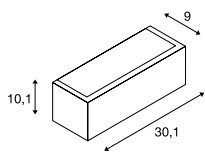

Product details

230V ~50Hz
Material: Aluminium / Glass

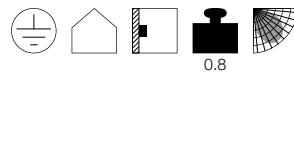

Dimensioned drawing

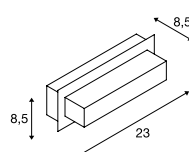

Recommended lamp

R7s 118mm 10.5W 330°
3000K 1050lm EEL=A+
11kWh/1000h
Item no. 560352

LED R7s 118mm 14W
3000K 2000lm EEL=A++
14kWh/1000h
Item no. 1002135

Lamp details

max. 200W QT-DE12

Variant	Item no.
480lm 3000K CRI>80 white	155221
480lm 3000K CRI>80 matt grey	155228

Variant	Item no.
R7s 118mm QT-DE12 matt aluminium	147566

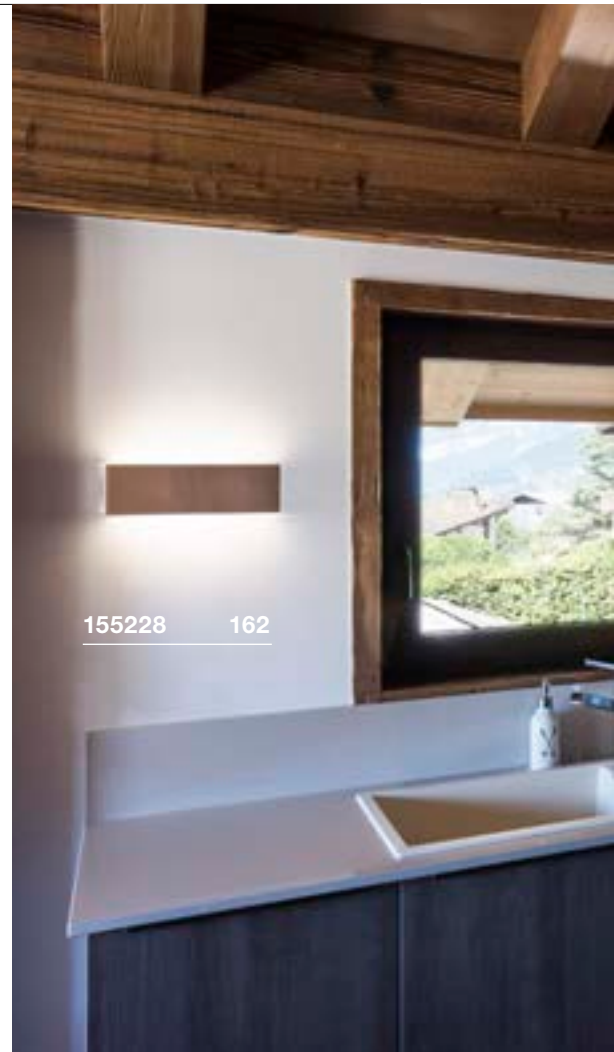



149511 163



149511 163

WL 149
WL, QT-DE12



Product details

230V ~50Hz
Material: Steel / Glass

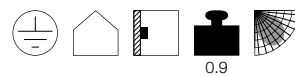

Dimensioned drawing

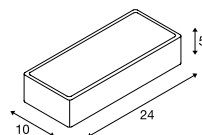

Recommended lamp

R7s 78mm 5.5W 330°
3000K 530lm EEL=A+
6kWh/1000h
Item no. 560332



Lamp details

max. 60W QT-DE12

Variant	Item no.
R7s 78mm QT-DE12	
□ matt white	149471
R7s 78mm QT-DE12	
■ chrome	149472

WL 149
WL



Product details

220-240V ~50/60Hz | 500mA
Total consumption: 16W
Material: Steel / Glass



Dimensioned drawing

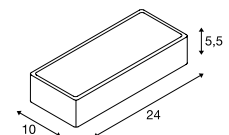

Variant	Item no.
1060lm 3000K CRI>80	
□ white	149511
1060lm 3000K CRI>80	
■ chrome	149512

SEDO 7
WL

A-A++ Range A++-E

LED INSIDE

NEW



SEDO 14
WL

A-A++ Range A++-E

LED INSIDE

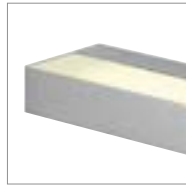

SEDO 21
WL

A-A++ Range A++-E

LED INSIDE

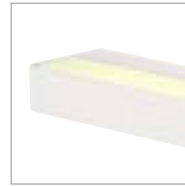

Product details

220-240V ~50/60Hz | 350mA
Total consumption: 11.5W
Material: Aluminium / Glass

IP 20 0.77 LED 30000

Product details

220-240V ~50/60Hz | 500mA
Total consumption: 16W
Material: Aluminium / Glass

IP 20 1.6 LED 30000

Product details

220-240V ~50/60Hz | 700mA
Total consumption: 30W
Material: Aluminium / Glass

IP 20 2.4 LED 30000

Dimensioned drawing

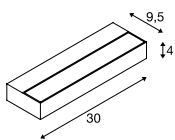

Dimensioned drawing

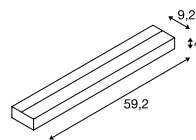

Dimensioned drawing

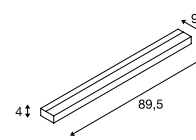

Variant	Item no.
1020lm 3000K CRI>80 □ white	1002962
1020lm 3000K CRI>80 □ matt aluminium	1002964

Variant	Item no.
1300lm 3000K CRI>80 □ white	151781
1300lm 3000K CRI>80 □ matt aluminium	151786

Variant	Item no.
2500lm 3000K CRI>80 □ white	151791
2500lm 3000K CRI>80 □ matt aluminium	151796



151781 164

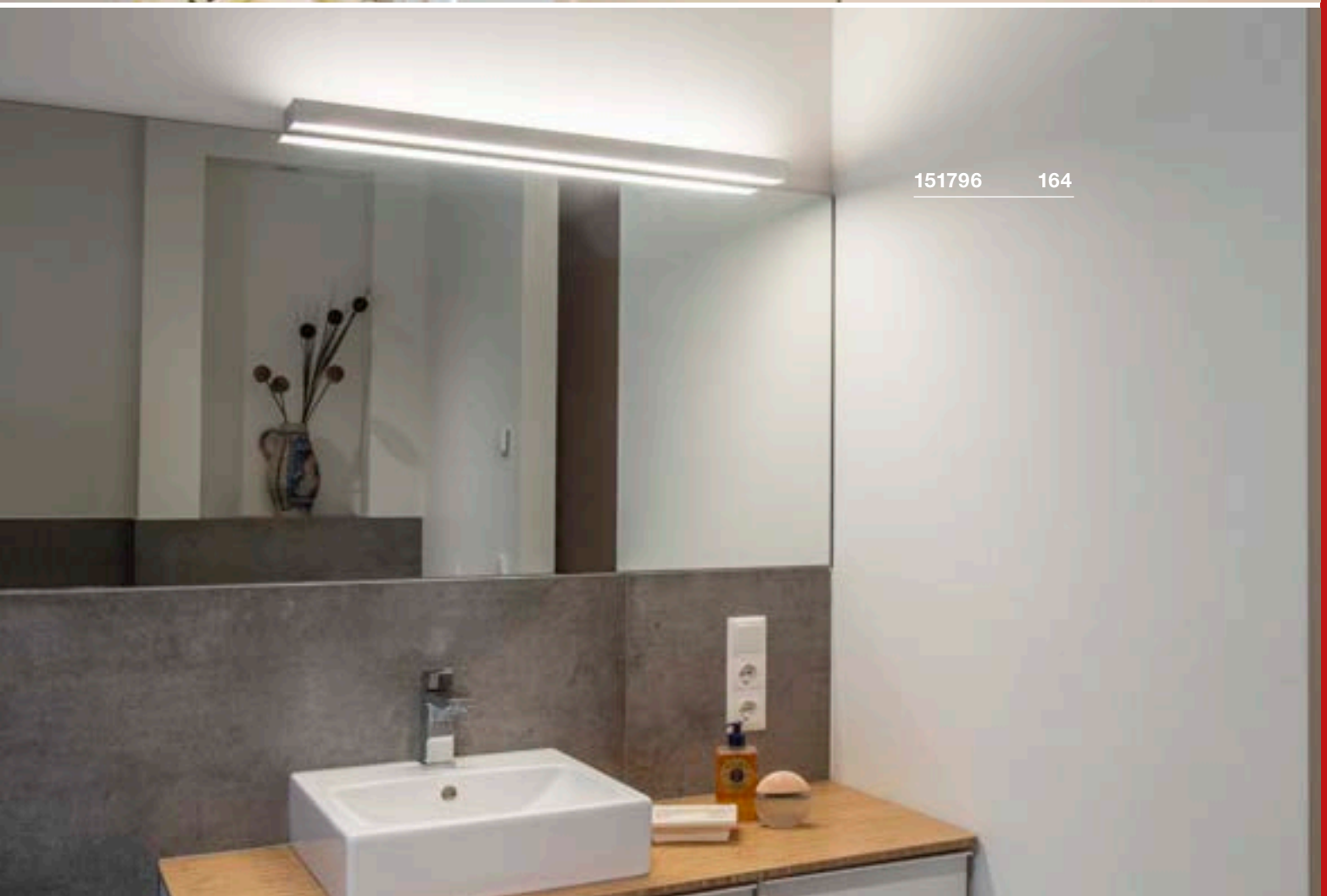

151796 164

ASSO 70
WL



Product details

100-240V ~50/60Hz | 500mA
Total consumption: 7.6W
Material: Aluminium / Steel



Dimensioned drawing

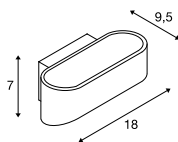

1000635 167

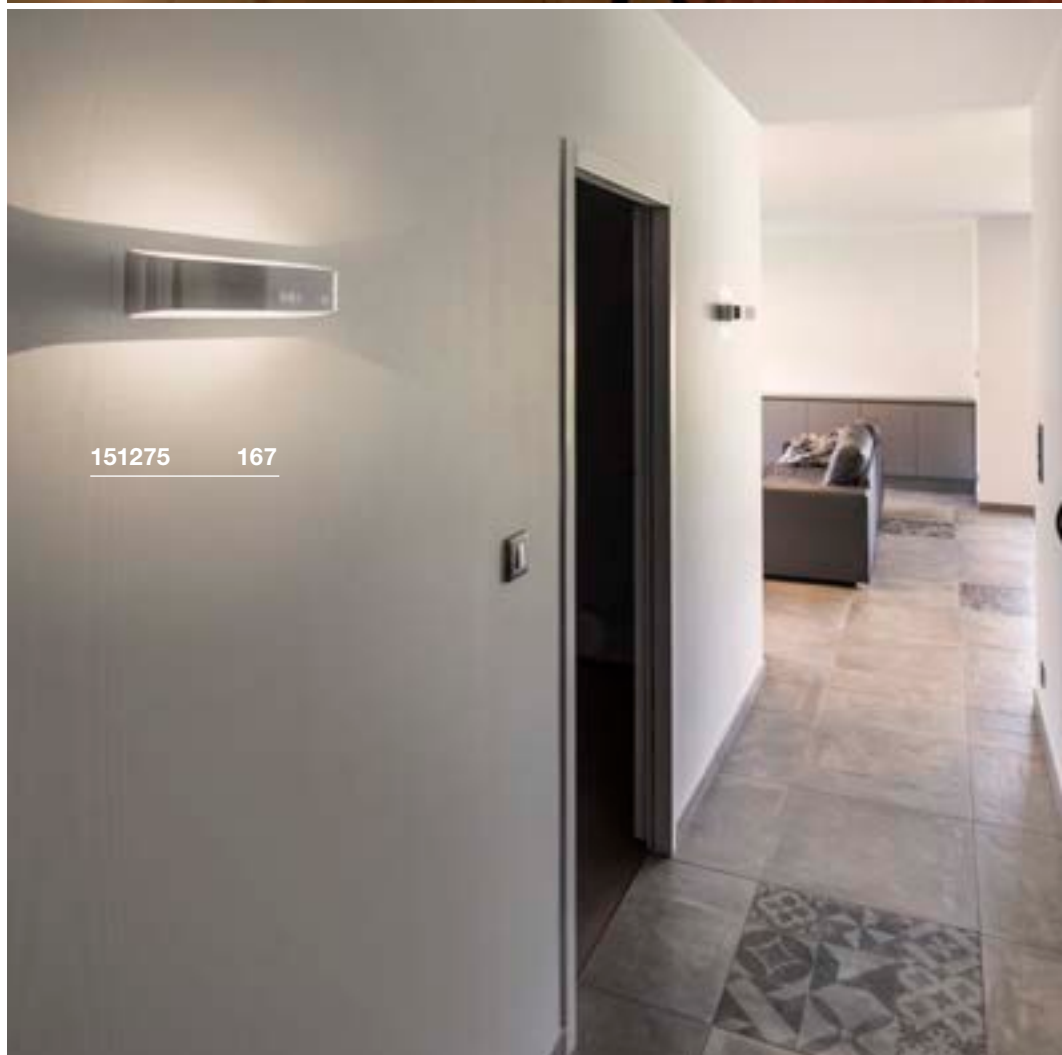

151275 167

Variant	Item no.
350lm 3000K CRI>80 white	151311
350lm 3000K CRI>80 matt aluminium / white	151315

ASSO 300
WL

A-A++ Range A++-E

LED INSIDE

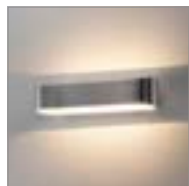

Product details

220-240V ~50/60Hz | 500mA
Total consumption: 12W
Material: Aluminium / Steel

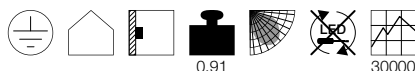

0.91

30000

Dimensioned drawing

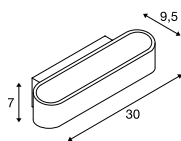

ASSO 300
WL

A-A++ Range A++-E

LED INSIDE

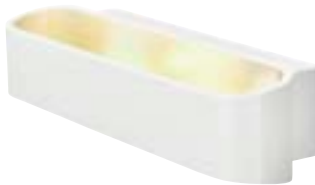

Product details

220-240V ~50/60Hz | 500mA
Total consumption: 22W
Material: Aluminium / Steel
Dimmable: Triac C, Triac L

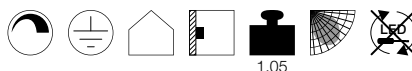

1.05



30000

Dimensioned drawing

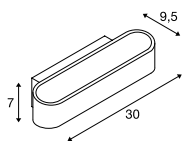

ASSO
WL

A-A++ Range A++-E

LED INSIDE



Product details

220-240V ~50/60Hz | 250mA
Total consumption: 12W
Material: Aluminium / Steel
Dimmable: Triac C

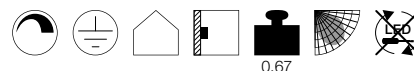

0.67



30000

Dimensioned drawing

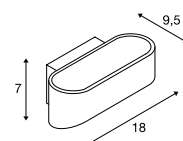

Variant	Item no.
700lm 3000K CRI>80	
□ white	151271
700lm 3000K CRI>80	
▒ matt aluminium / white	151275

Variant	Item no.
1040lm 2000-3000K CRI>90	
□ white	1000634
1040lm 2000-3000K CRI>90	
▒ matt aluminium / white	1000635

Variant	Item no.
530lm 2000-3000K CRI>90	
□ white	1000636
530lm 2000-3000K CRI>90	
▒ matt aluminium / white	1000637

OSSA 180
WL, QT-DE12



OSSA 300
WL, QT-DE12



Product details

230V ~50Hz
Material: Aluminium / Steel

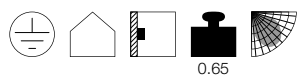

0.65

Dimensioned drawing

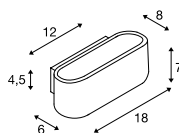

Recommended lamp

R7s 78mm 5.5W 330°
3000K 530lm EEL=A+
6kWh/1000h
Item no. 560332



Lamp details

max. 100W QT-DE12

Variant	Item no.
R7s 78mm QT-DE12	
■ black	151450
R7s 78mm QT-DE12	
□ white	151451
R7s 78mm QT-DE12	
▒ matt aluminium	151456

Product details

230V ~50Hz
Material: Aluminium / Steel

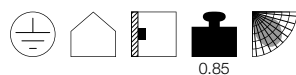

0.85

Dimensioned drawing

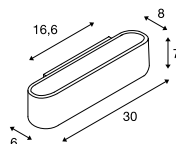

Recommended lamp

R7s 118mm 10.5W 330°
3000K 1050lm EEL=A+
11kWh/1000h
Item no. 560352



LED R7s 118mm 14W
3000K 2000lm EEL=A++
14kWh/1000h
Item no. 1002135



Lamp details

max. 120W QT-DE12

Variant	Item no.
R7s 118mm QT-DE12	
■ black	151410
R7s 118mm QT-DE12	
□ white	151411
R7s 118mm QT-DE12	
▒ matt aluminium / white	151416



151450 168



151450 168



1002239 169

ARLINA 60/130
WL

A-A++ Range A++-E

LED INSIDE

NEW



Product details

220-240V ~50/60Hz | 500mA
Material: Aluminium / Glass
Product dimensions: W: 6.8 cm H: 6 cm

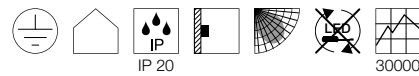

ARLINA 60/130
WL, T16

A-A+ Range A++-E

LED INSIDE



Product details

220-240V ~50/60Hz
Total consumption: 31.5W
Material: Aluminium

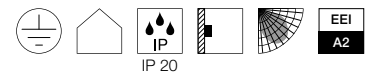

Dimensioned drawing

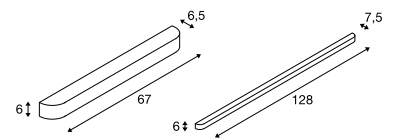

Recommended lamp

LED G5 28W
3000K 2600lm EEL=A+
44kWh/1000h
Item no. 548028

Lamp details

28W T16



155216 169

Variant	Item no.
1400lm 3000K CRI>80 20W L: 67 cm 2.2 kg aluminium	1002239
2400lm 3000K CRI>80 28W L: 128 cm 3.9 kg aluminium	1002240

Variant	Item no.
G5 T16 L: 67 cm 2.2 kg aluminium	155206
G5 T16 L: 128 cm 3.8 kg aluminium	155216

PLASTRA
WL, curve



A-A++ Range A++-E



• 240V LED

Product details

230V ~50Hz
Total consumption: 19W
Material: Plaster / Glass
Dimmable: Triac C, Triac L

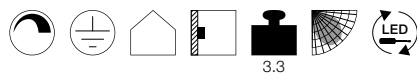

3.3

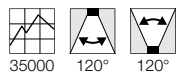

35000 120° 120°

Dimensioned drawing

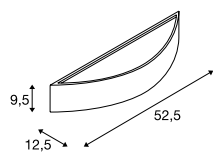

148062 170

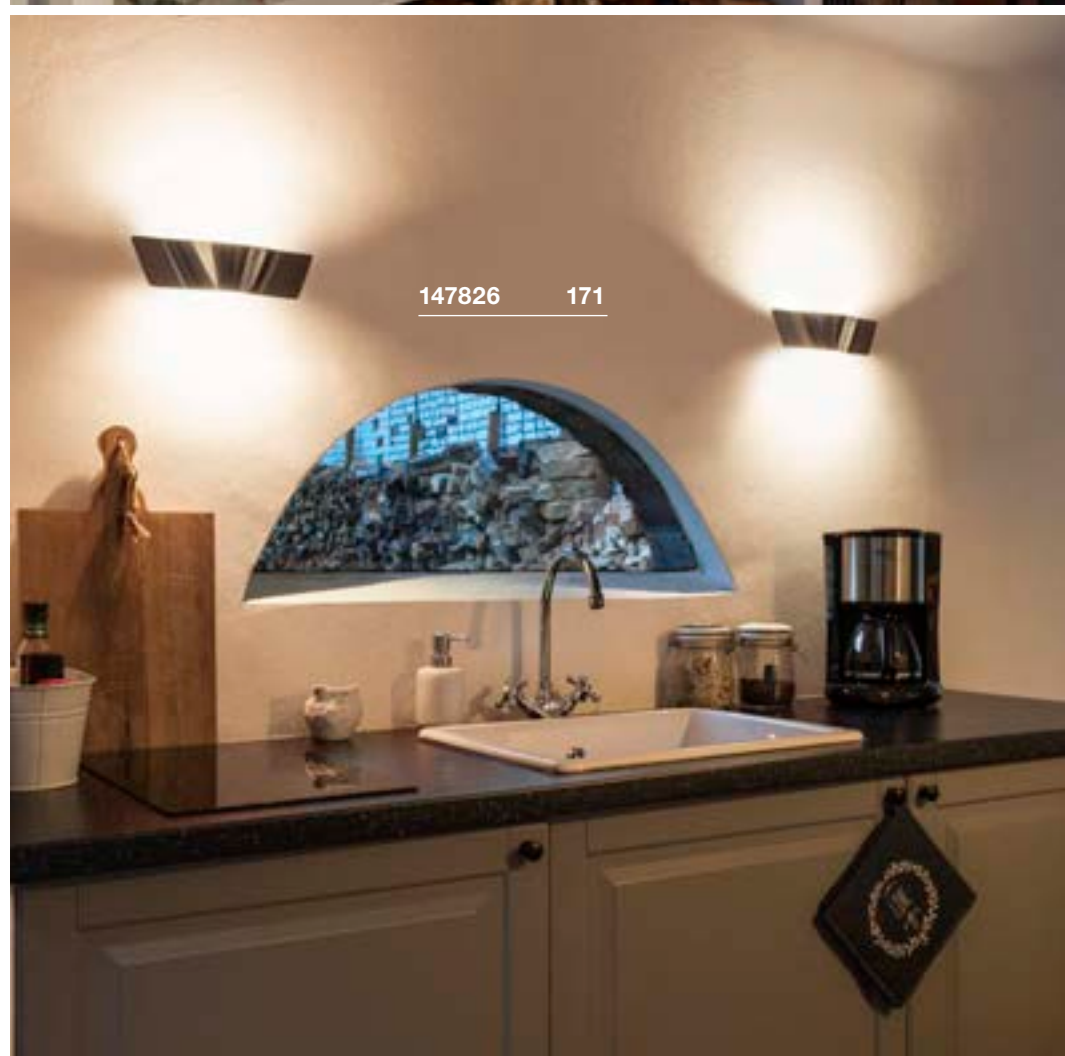

147826 171

Variant Item no.

Up: 520lm | 3000K | CRI>80

Down: 520lm | 3000K | CRI>80

□ white/matt transparent 148062

WAVE 25
WL



A-A++ Range A++-E

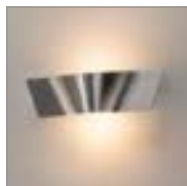

WAVE 45
WL



A-A++ Range A++-E

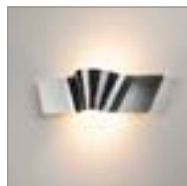

- Premium LED with CRI>90

Product details

220-240V ~50/60Hz | 500mA
Total consumption: 11.5W
Material: Aluminium
Dimmable: Triac C, Triac L

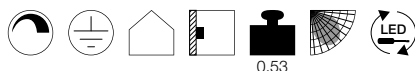

Dimensioned drawing

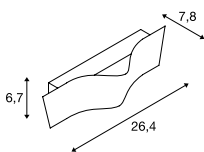

Variant	Item no.
830lm 3000K CRI>80 □ white	147821
700lm 3000K CRI>80 ■ gold	147823
830lm 3000K CRI>80 ▒ matt aluminium	147826

WAVE 45
WL



A-A++ Range A++-E

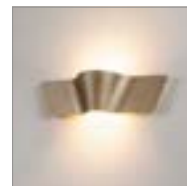

- Premium LED with CRI>90
- Dim to Warm
- Light colour changes when dimming

Product details

220-240V ~50/60Hz | 500mA
Total consumption: 22W
Material: Aluminium / Steel
Dimmable: Triac C, Triac L

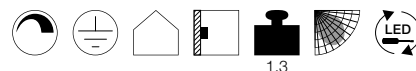

Dimensioned drawing

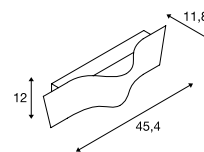

Variant	Item no.
1050lm 2000-3000K CRI>90 □ white	1000650
900lm 2000-3000K CRI>90 ■ gold	1000651
1050lm 2000-3000K CRI>90 ▒ aluminium / white	1000652

CARISO
WL

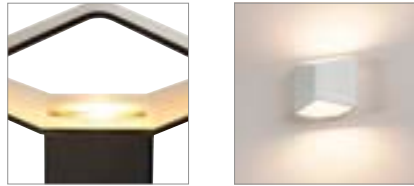

- The different lamp interior colours produce different light colours

Product details

220-240V ~50/60Hz | 500mA
Total consumption: 11W
Material: Aluminium / Steel
Dimmable: Triac C, Triac L

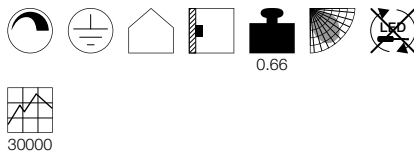

Dimensioned drawing

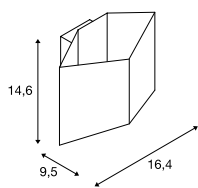

CARISO
WL

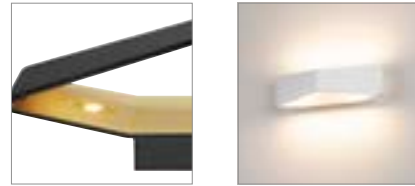

- Premium LED with CRI>90
- The different lamp interior colours produce different light colours

Product details

220-240V ~50/60Hz | 500mA
Total consumption: 22W
Material: Aluminium / Steel
Dimmable: Triac C, Triac L

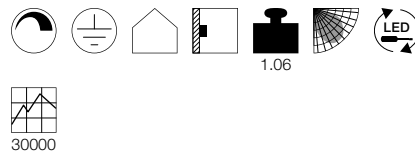

Dimensioned drawing

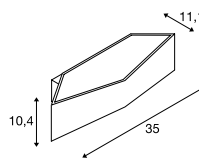

Variant	Item no.
200lm 2700K CRI>90 ■ black / gold	151710
390lm 3000K CRI>90 □ white	151711

Variant	Item no.
500lm 1700-2700K CRI>90 ■ black / gold	151740
900lm 2000-3000K CRI>90 □ white	151741



151610 173

LED SAIL
WL



A-A++ Range A++-E



Product details

100-240V ~50/60Hz | 700mA
Total consumption: 3.5W
Material: Aluminium / Steel

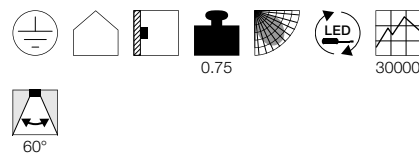

Dimensioned drawing

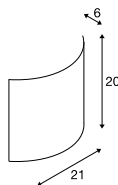

Variant	Item no.
110lm 3000K CRI>80	
■ black	151600
140lm 3000K CRI>80	
□ white	151601

LED SAIL
WL



A-A++ Range A++-E



Product details

100-240V ~50/60Hz | 700mA
Total consumption: 6W
Material: Aluminium / Steel

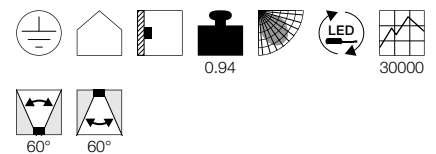

Dimensioned drawing

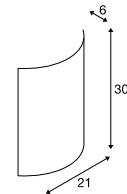

Variant	Item no.
Up: 85lm 3000K CRI>80	
Down: 85lm 3000K CRI>80	
■ black	151610
Up: 120lm 3000K CRI>80	
Down: 120lm 3000K CRI>80	
□ white	151611

PLASTRA UP/DOWN
WL, curve



A-A++ Range A++-E

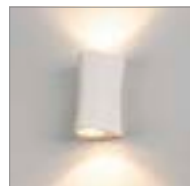

- Can be individually designed with colours, stickers and more

Product details

220-240V ~50/60Hz | 700mA
Total consumption: 6.6W
Material: Plaster / Steel
Dimmable: Triac C, Triac L

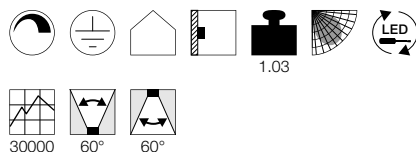

Dimensioned drawing

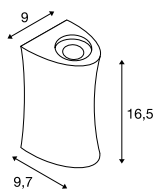

PLASTRA 104
WL, QT14



D-A+ Range A++-E

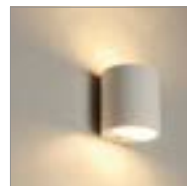

- Can be individually designed with colours, stickers and more

Product details

230V ~50Hz
Material: Plaster / Steel

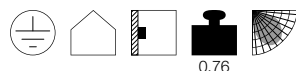

Dimensioned drawing

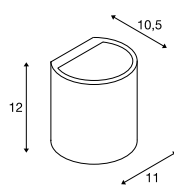

Recommended lamp

G9 2.5W
2700K 180lm EEL=A+
3kWh/1000h
Item no. 560302



LED G9 3.5W
2800K 300lm EEL=A+
4kWh/1000h
Item no. 1002131



Lamp details

max. 42W QT14

Variant	Item no.
Up: 125lm 3000K CRI>80 Down: 125lm 3000K CRI>80 □ white	1001271

Variant	Item no.
G9 QT14 □ white	148016

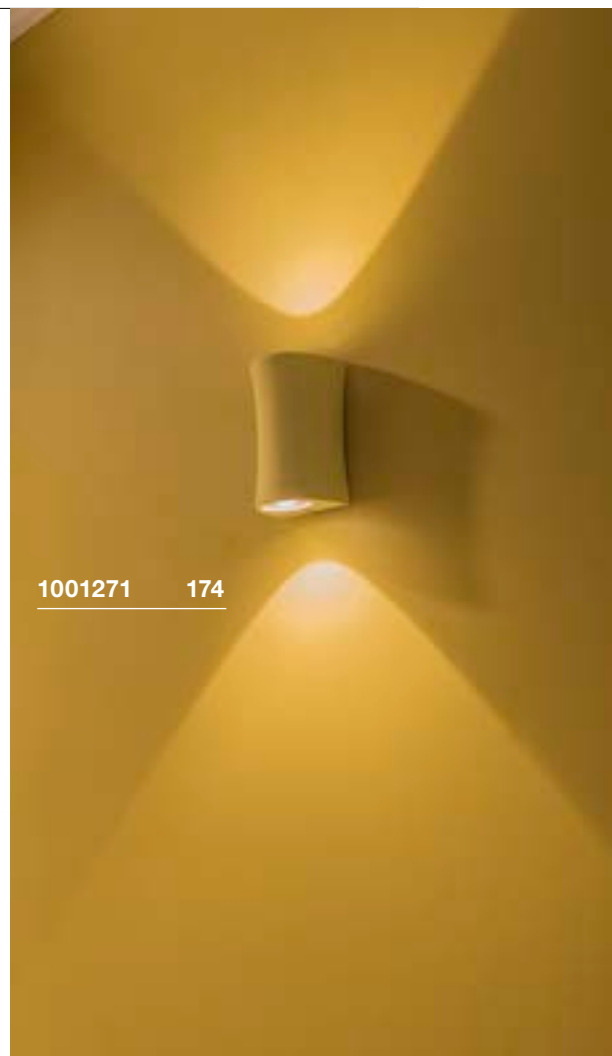

1001271 174

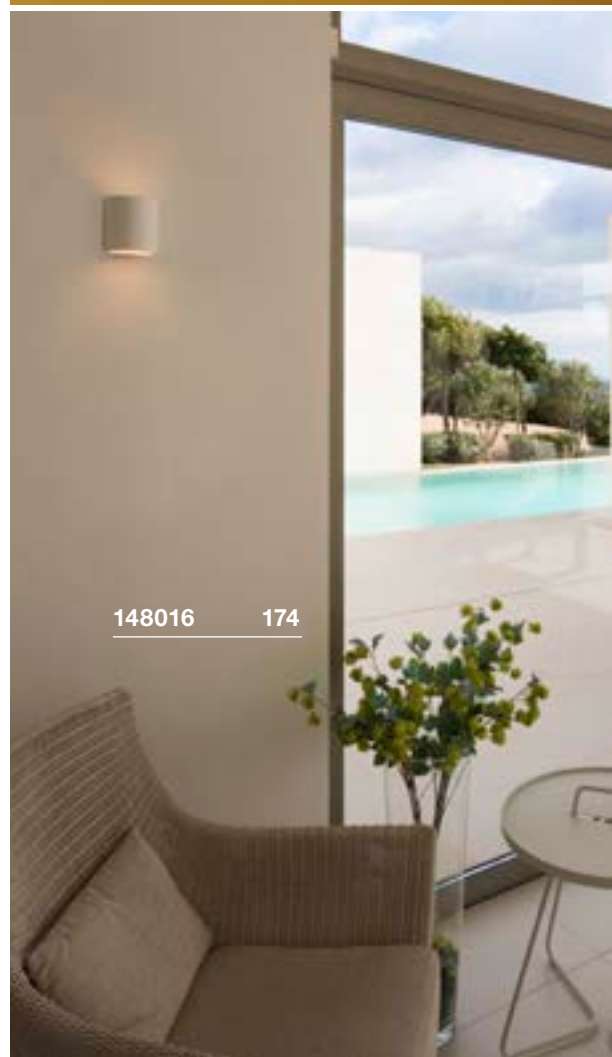

148016 174



148060 175

PLASTRA
WL, QPAR51

893

E-A++ Range A++-E

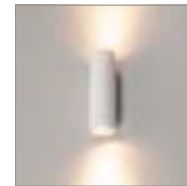

- Can be individually designed with colours, stickers and more

Product details

220-240V ~50/60Hz
Material: Plaster / Steel

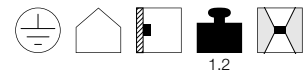

Dimensioned drawing

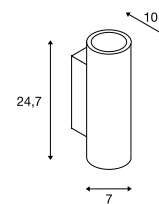

Recommended lamp

LED GU10 7.2W 36°
2700K 470lm EEL=A+
8kWh/1000h
Item no. 560542



LED GU10 7.2W 36°
3000K 520lm EEL=A+
8kWh/1000h
Item no. 1001561



Lamp details

2x max. 35W QPAR51

Variant	Item no.
GU10 QPAR51 □ white	148060

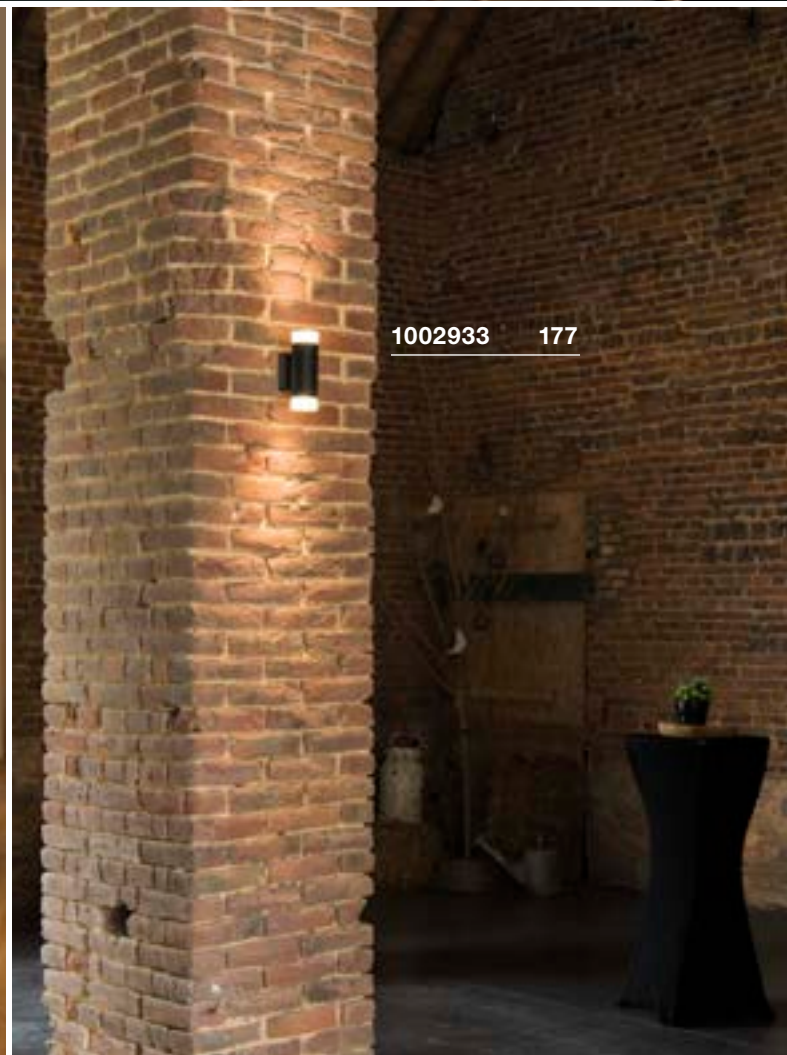
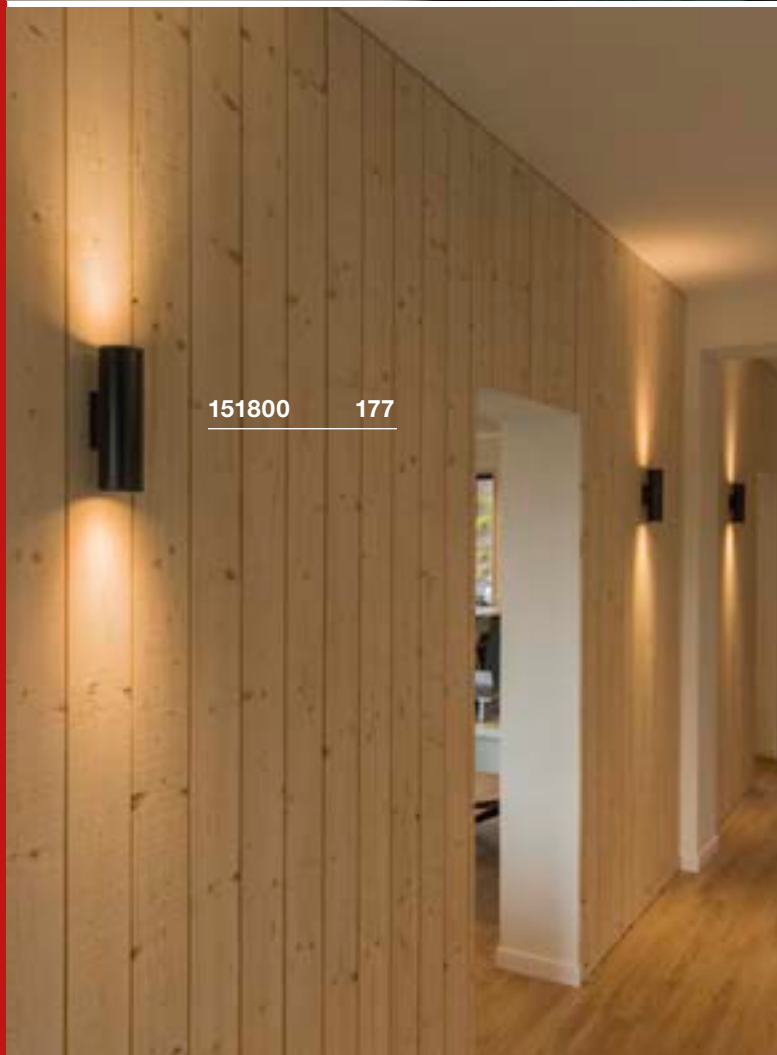
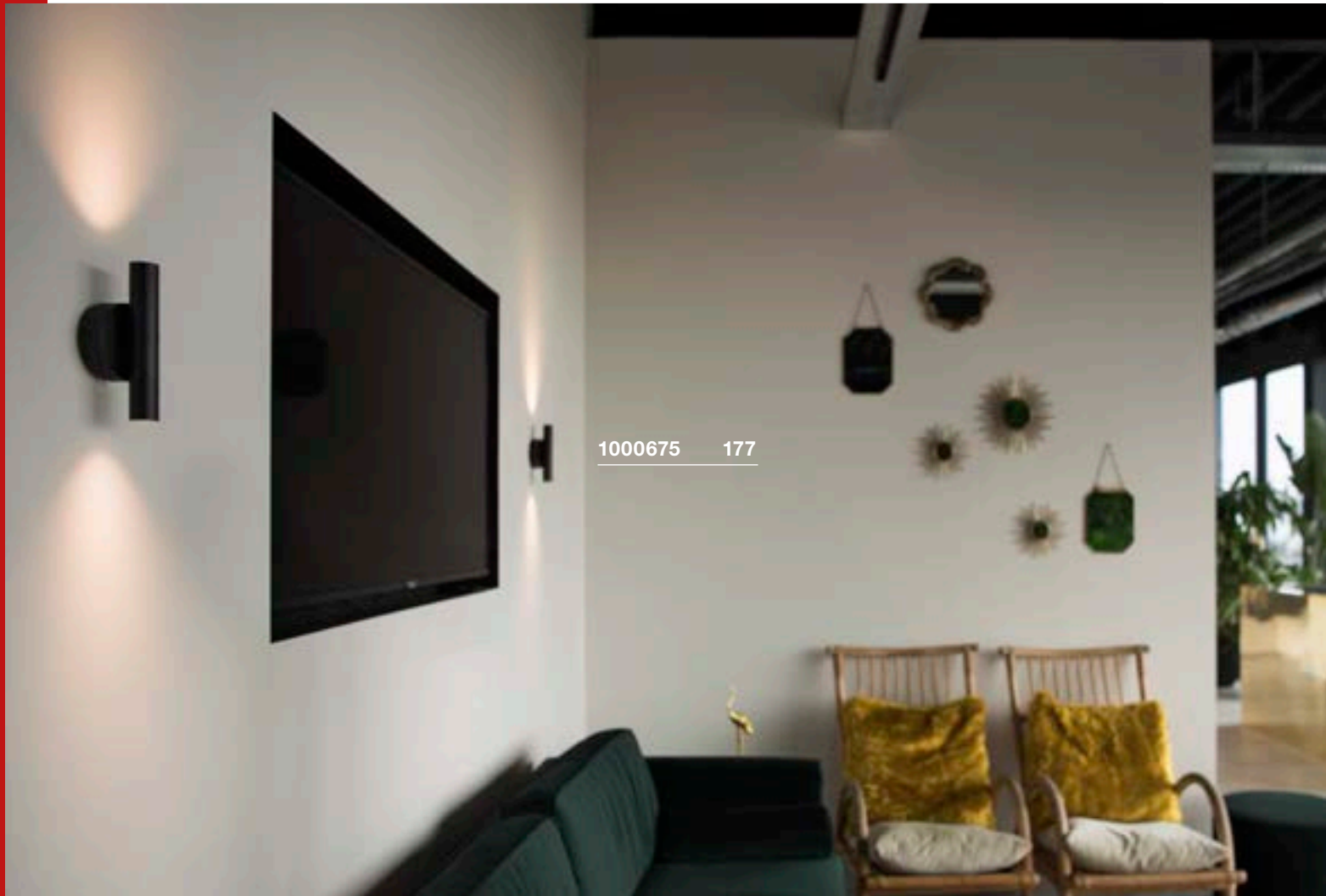

KARPO UP/DOWN WL

889

A-A++ Range A++-E



- Premium LED with CRI>90

Product details

100-240V ~50/60Hz | 450mA
Total consumption: 10W
Material: Aluminium



Dimensioned drawing

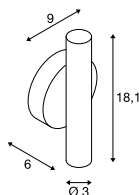

Variant	Item no.
Up: 320lm 3000K CRI>90 Down: 320lm 3000K CRI>90	
■ black	1000675
Up: 370lm 3000K CRI>90 Down: 370lm 3000K CRI>90	
□ white	1000676
Up: 340lm 3000K CRI>90 Down: 340lm 3000K CRI>90	
■ gold	1002174

ENOLA B WL, QPAR51

885

E-A++ Range A++-E



Product details

230V ~50Hz
Material: Aluminium / Steel

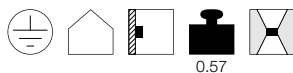

Dimensioned drawing

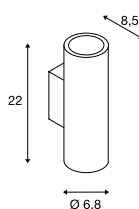

Recommended accessories

■ Deco ring
Item no. 151840

Recommended lamp

LED GU10 7.2W 36°
2700K 470lm EEL=A+
8kWh/1000h
Item no. 560542

LED GU10 7.2W 36°
3000K 520lm EEL=A+
8kWh/1000h
Item no. 1001561

Lamp details

2x max. 50W QPAR51
L: 8.5 cm max.

Variant	Item no.
GU10 QPAR51	
■ black	151800
GU10 QPAR51	
□ white	151801
GU10 QPAR51	
■ gold	151803
GU10 QPAR51	
■ grey / black	151804

ASTINA UP/DOWN WL, QPAR51

884

A-A++ Range A++-E



- High-quality, frosted glass

Product details

220-240V ~50/60Hz
Material: Aluminium / Steel

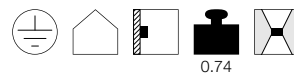

Dimensioned drawing

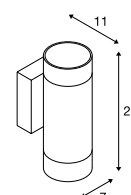

Lamp details

2x max. 10W QPAR51

Variant	Item no.
GU10 QPAR51	
□ matt white / matt white	1002931
GU10 QPAR51	
■ matt grey / matt grey	1002932
GU10 QPAR51	
■ matt black / matt black	1002933

ROX
WL, QPAR111



E-A++ Range A++-E



- High-quality brushed finis

Product details

230V ~50Hz
Material: Aluminium / Glass

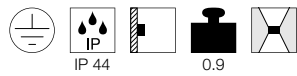

Dimensioned drawing

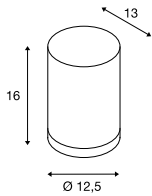

Recommended lamp

LED GU10 10W 38°
3000K 630lm EEL=A+
10kWh/1000h
Item no. 1001029



LED GU10 13W 30°
4000K 1300lm EEL=A+
13kWh/1000h
Item no. 1001243



Lamp details

max. 50W QPAR111

Variant	Item no.
GU10 QPAR111	
brushed aluminium	1000333

ROX UP/DOWN
WL, QPAR111



E-A++ Range A++-E



- High-quality brushed finis

Product details

230V ~50Hz
Material: Aluminium / Glass

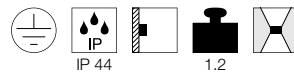

Dimensioned drawing

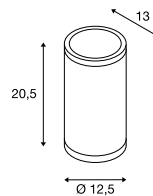

Recommended lamp

LED GU10 10W 38°
3000K 630lm EEL=A+
10kWh/1000h
Item no. 1001029



LED GU10 13W 30°
4000K 1300lm EEL=A+
13kWh/1000h
Item no. 1001243



Lamp details

2x max. 50W QPAR111

Variant	Item no.
GU10 QPAR111	
brushed aluminium	1000334

1000334 178



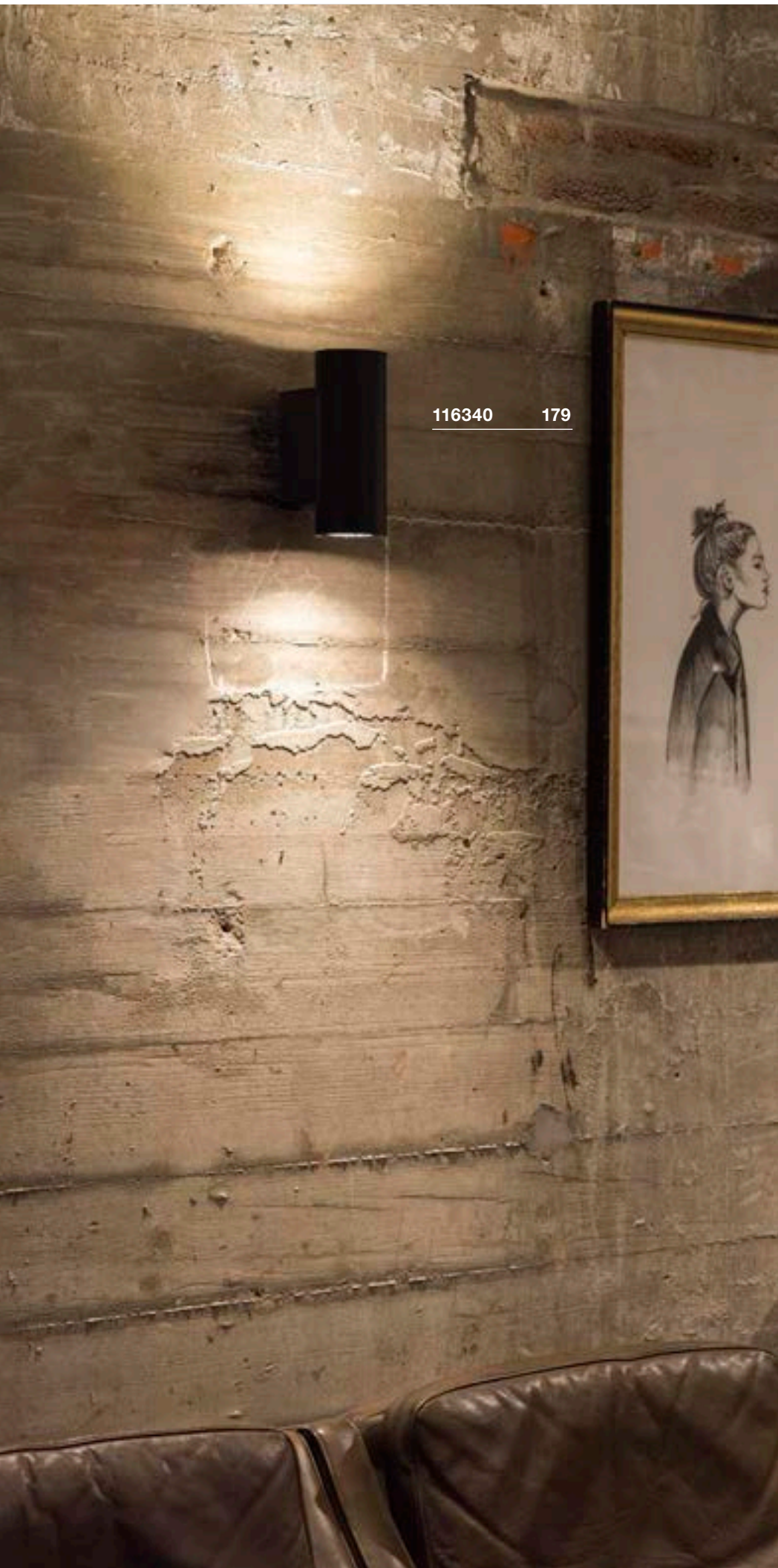

116340 179

SUPROS 78 UP/DOWN
WL
 897
A-A++ Range
A++-ELED
INSIDE

Product details

220-240V ~50/60Hz | 250mA
 Total consumption: 24W
 Material: Aluminium
 Dimmable: Triac C, Triac L

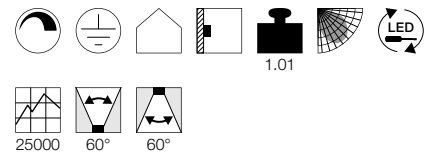

Dimensioned drawing

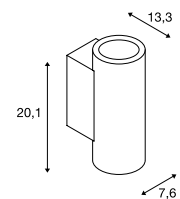

Recommended accessories

Lens, 20°

Item no. 116302

Lens, 40°

Item no. 116304

Variant	Item no.
Up: 700lm 3000K CRI>80 Down: 700lm 3000K CRI>80	
■ black	116340
Up: 700lm 3000K CRI>80 Down: 700lm 3000K CRI>80	
□ white	116341

PLASTRA 101
WL, E14



E-A++ Range A++-E



- Can be individually designed with colours, stickers and more

Product details

230V ~50Hz
Material: Plaster / Steel

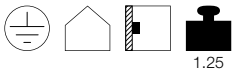

1.25

Dimensioned drawing

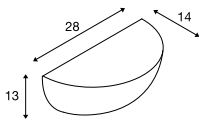

Recommended lamp

LED E14 6.5W 280°
3000K 480lm EEL=A+
7kWh/1000h
Item no. 560372



LED E14 4W
2700K 250lm EEL=A+
4kWh/1000h
Item no. 560222



Lamp details

max. 40W C35
Ø: 4.5 cm max. L: 11 cm max.

Variant	Item no.
E14 C35	
□ white	148013

PLASTRA
WL, curve, QT-DE12



D-A+ Range A++-E



- Can be individually designed with colours, stickers and more

Product details

230V ~50Hz
Material: Plaster / Steel

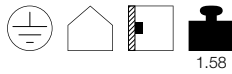

1.58

Dimensioned drawing

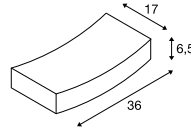

Recommended lamp

R7s 78mm 5.5W 330°
3000K 530lm EEL=A+
6kWh/1000h
Item no. 560332



Lamp details

max. 100W QT-DE12

Variant	Item no.
R7s 78mm QT-DE12	
□ white	148012

PLASTRA
WL, cone, TCR-TSE



B-A++ Range A++-E



- Can be individually designed with colours, stickers and more

Product details

230V ~50Hz
Material: Plaster / Steel

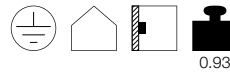

0.93

Dimensioned drawing

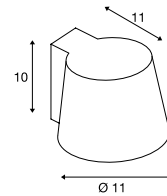

Recommended lamp

GX53 4.2W 35°
3000K 200lm EEL=A
5kWh/1000h
Item no. 550092



LED GX53 7.5W 120°
4000K 620lm EEL=A+
8kWh/1000h
Item no. 1001221



Lamp details

max. 11W TCR-TSE

Variant	Item no.
GX53 TCR-TSE	
□ white	148061



148061 180



148013 180

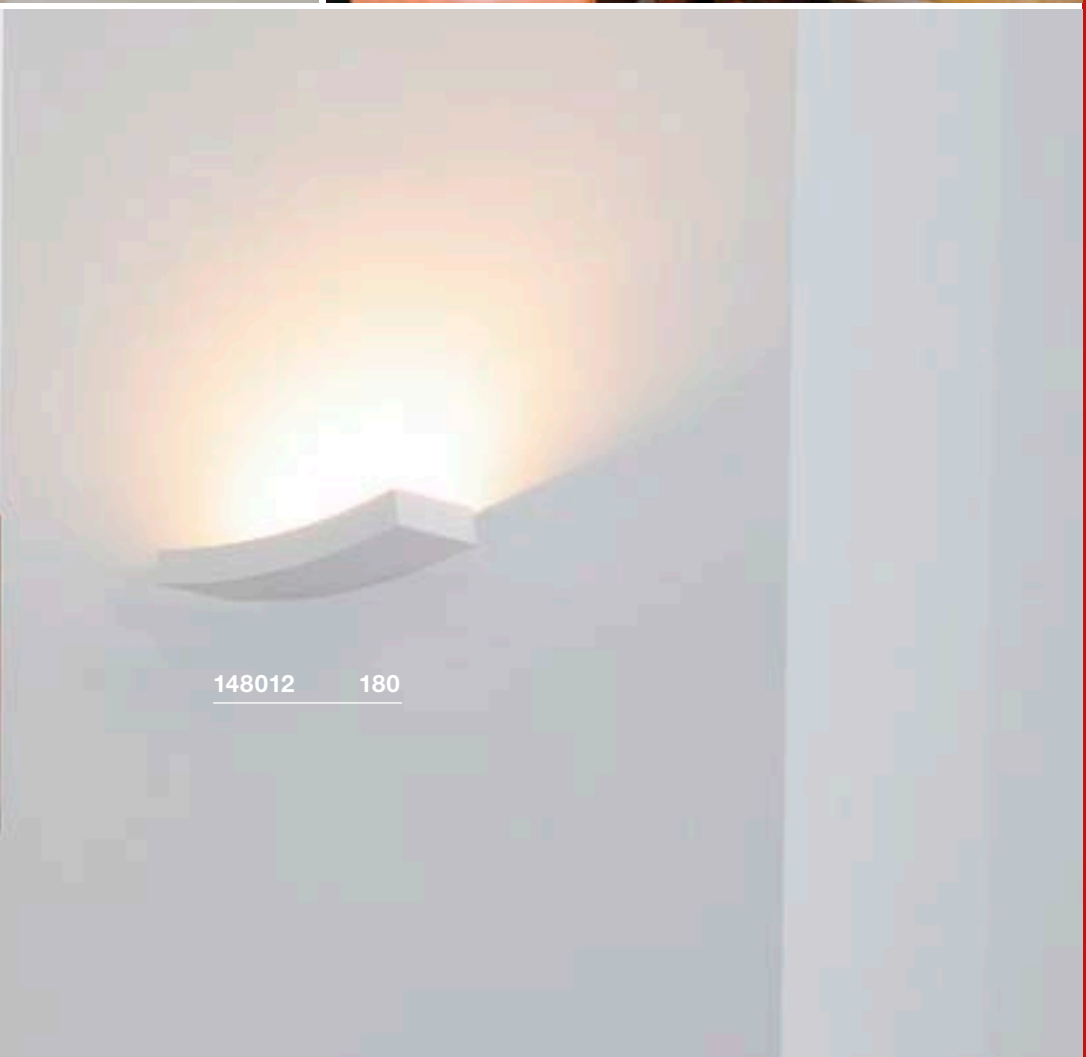
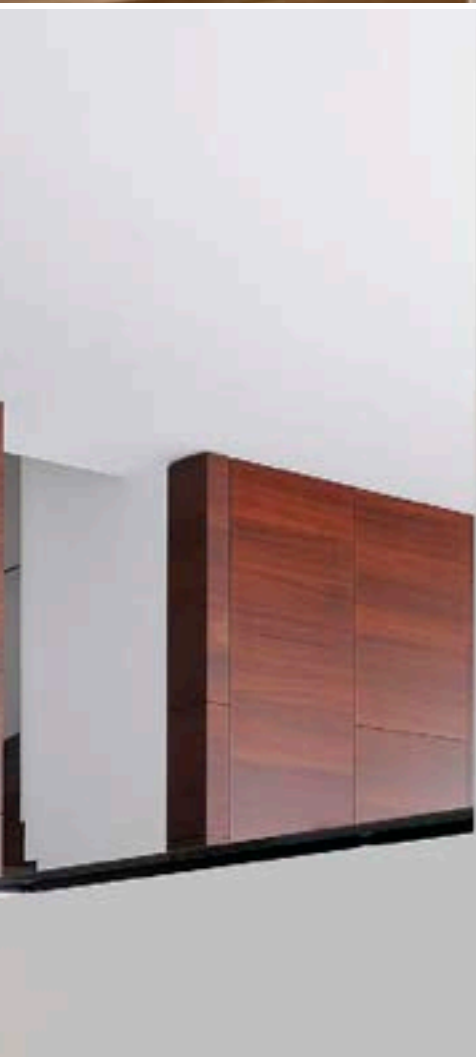

148012 180



1000340 183

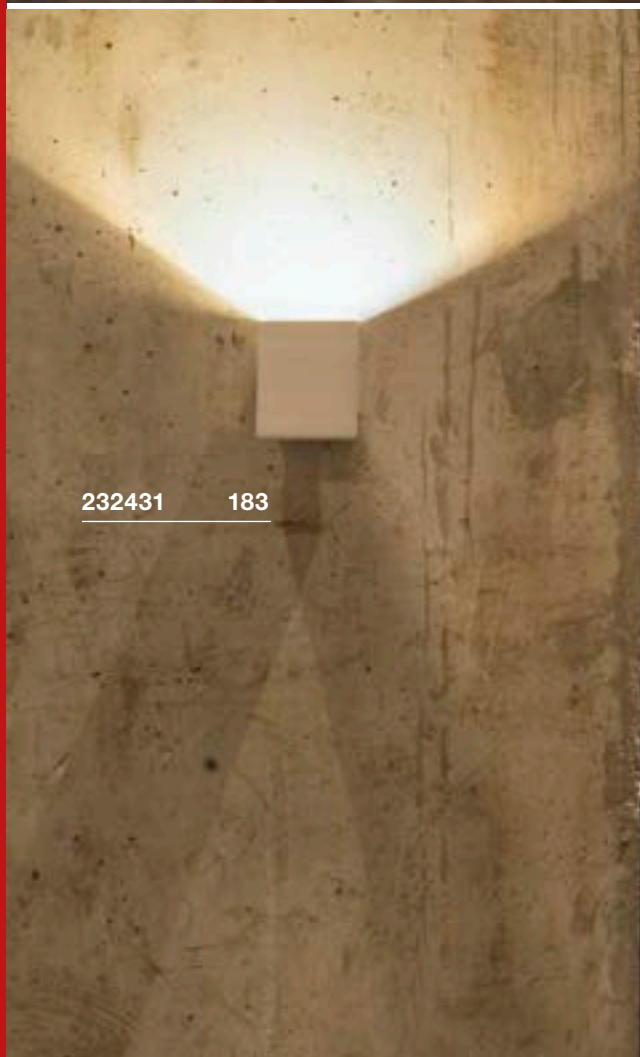
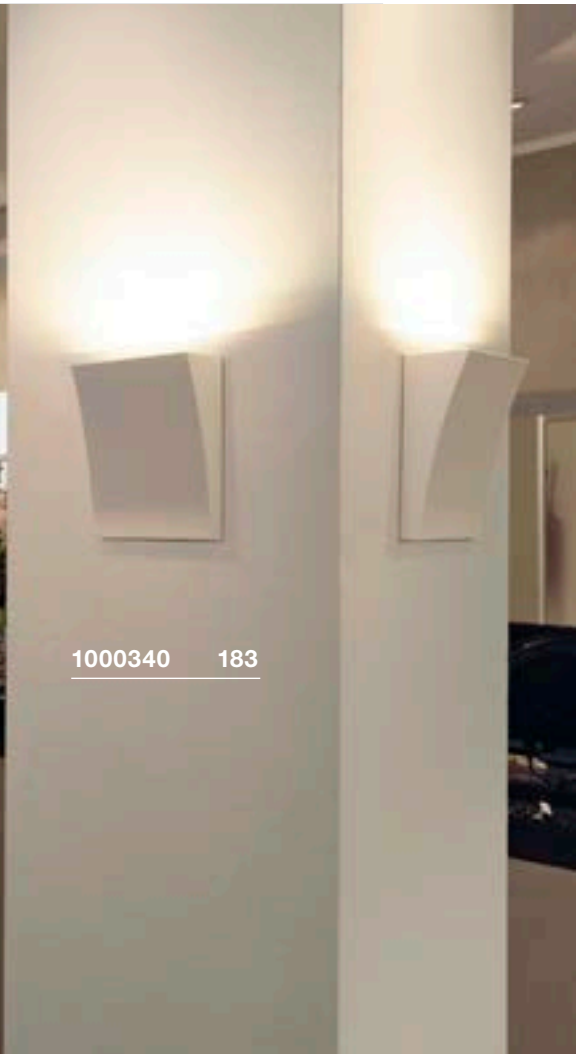

232431 183



DELWA
WL

A-A++ Range A++-E



Product details

100-240V ~50/60Hz | 700mA
Total consumption: 10W
Material: Aluminium / Glass

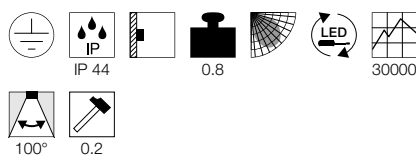

Dimensioned drawing

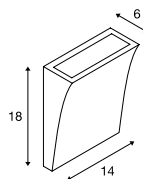

Variant	Item no.
910lm 3000K CRI>80	
□ white	1000340
910lm 3000K CRI>80	
■ grey	1000341
910lm 3000K CRI>80	
■ anthracite	1000342

QUAD
WL



A-A++ Range A++-E



Product details

200-240V ~50/60Hz | 700mA
Total consumption: 4.6W
Material: Aluminium / Glass

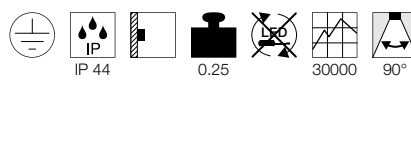

Dimensioned drawing

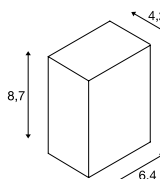

Variant	Item no.
100lm 3000K CRI>80	
□ white	232461
80lm 3000K CRI>80	
■ anthracite	232465

BIG QUAD
WL

A-A++ Range A++-E

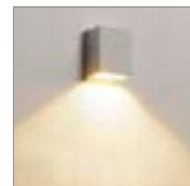

Product details

100-277V ~50/60Hz | 350mA
Total consumption: 4.5W
Material: Aluminium / Glass

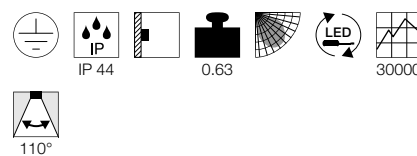

Dimensioned drawing

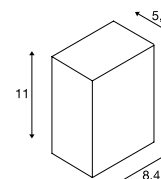

Variant	Item no.
290lm 3000K CRI>80	
□ white	232431
260lm 3000K CRI>80	
■ anthracite	232435

PEMA®
WL

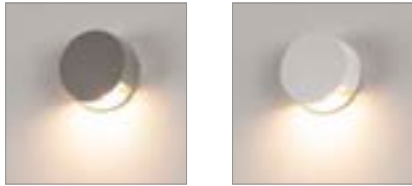

Product details

230V ~50Hz
Total consumption: 4.7W
Material: Aluminium / Glass



Dimensioned drawing

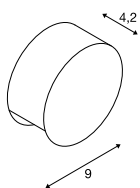

Note

Protection class IP44 only when mounted with the light emission opening pointing downwards.

LYNAH
WL



- Luminaire can be rotated in multiple directions. Swivels by 180°.

Product details

220-240V ~50/60Hz | 350mA
Total consumption: 14W
Material: Aluminium / Polycarbonate (PC)
Dimmable: Triac C

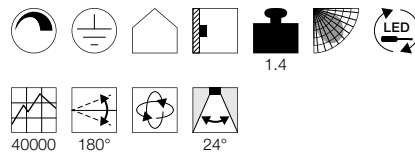

Dimensioned drawing

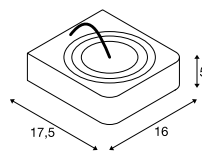

Note

Protection class IP44 only when mounted with the light emission opening pointing downwards.

Variant	Item no.
125lm 3000K CRI>80 □ white	231010
125lm 3000K CRI>80 ■ grey	231012
125lm 3000K CRI>80 ■ anthracite	231015

Variant	Item no.
950lm 3000K CRI>80 ■ black	1000414
950lm 3000K CRI>80 □ white	1000415



1000414 184



231012 184

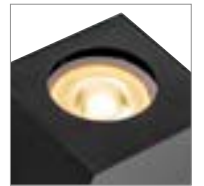

151564 185

ALTRA DICE
WL, QPAR51
 883
E-A++ Range
A++-E

Product details

220-240V ~50/60Hz
Material: Aluminium / Steel

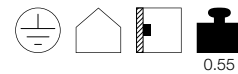

Dimensioned drawing

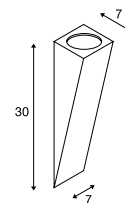

Recommended lamp

GU10 5.5W 36°
2800K 420lm EEL=A+
6kWh/1000h
Item no. 1001217



LED GU10 5.5W 38°
2700K 400lm EEL=A+
6kWh/1000h
Item no. 1001030



Lamp details

max. 50W QPAR51

Variant	Item no.
GU10 QPAR51 □ white	151561
GU10 QPAR51 ■ grey	151564
GU10 QPAR51 ■ black	1002213



1002213 185

SHELL 15
WL, TRIAC

A-A++ Range A++-E



- Indirect lighting

Product details

220-240V ~50/60Hz | 350mA
Total consumption: 15W
Material: Aluminium / Acrylic
Dimmable: Triac C, Triac L

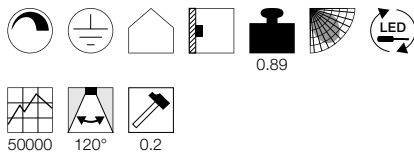

Dimensioned drawing

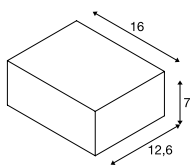

SHELL 30
WL, TRIAC

A-A++ Range A++-E



- Indirect lighting

Product details

220-240V ~50/60Hz | 700mA
Total consumption: 54W
Material: Aluminium / Acrylic
Dimmable: Triac C

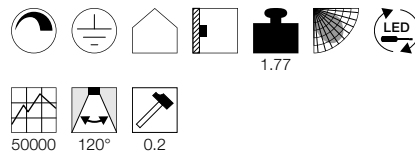

Dimensioned drawing

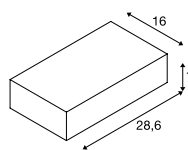

1000423 186

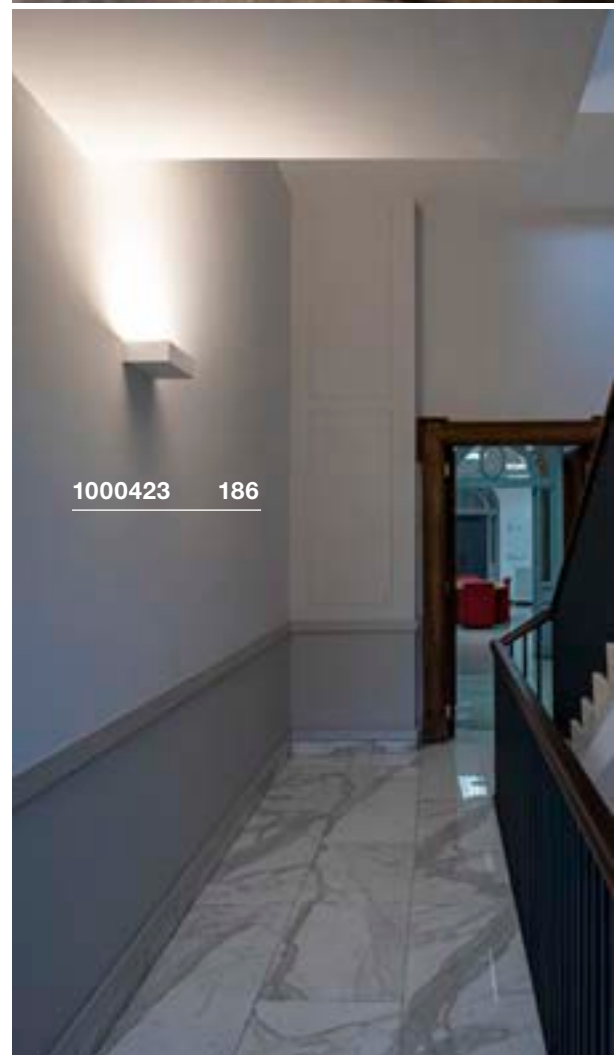

1000423 186

Variant	Item no.
1400lm 3000K CRI>80 □ white	1000422

Variant	Item no.
5600lm 3000K CRI>80 □ white	1000423



1000422 186

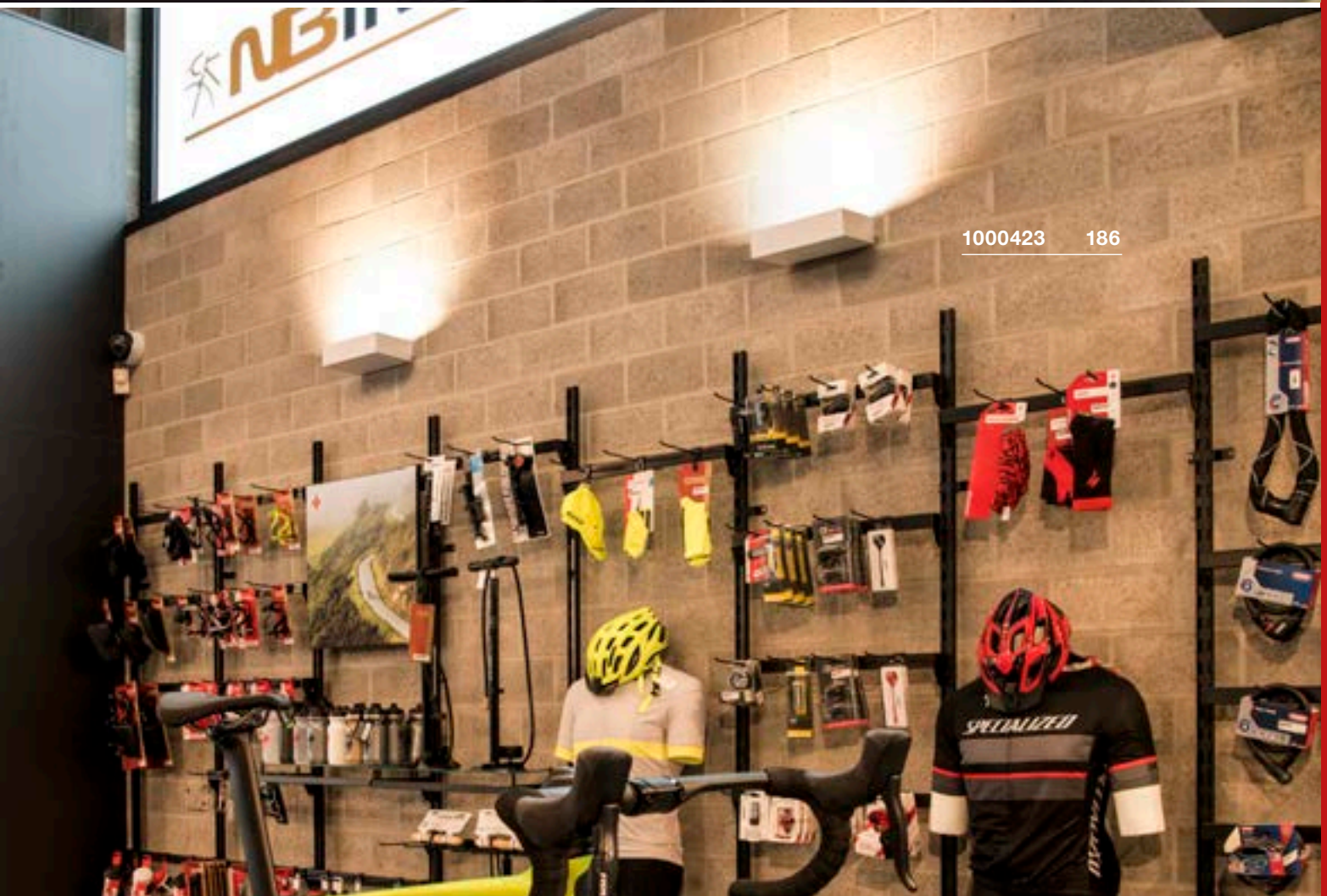

1000423 186

LENITO
WL



1002920 188

A-A++ Range
A++-E

LED
INSIDE

NEW



Product details

220-240V ~50/60Hz | 160mA
Total consumption: 24W
Material: Aluminium / Polycarbonate (PC)

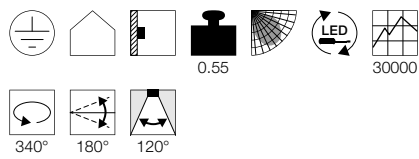

Dimensioned drawing

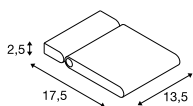

Variant	Item no.
2450lm 3000K CRI>80	
■ black	1002920
2540lm 3000K CRI>80	
□ white	1002921

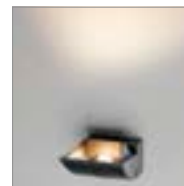
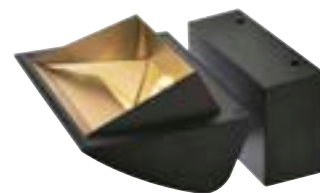

1001496 189

MERADO FLOOD
WL
 891
A-A++ Range
A++-ELED
INSIDE

- Asymmetric light distribution

Product details

220-240V ~50/60Hz | 1000mA
 Total consumption: 40W
 Material: Aluminium
 Dimmable: Triac C, Triac L

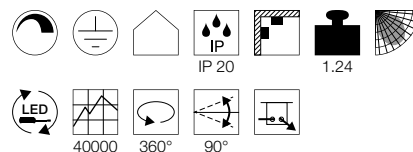

Dimensioned drawing

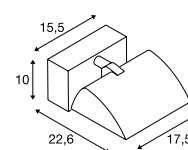

Variant	Item no.
3000lm 3000K CRI>80 ■ black	1001469
3000lm 3000K CRI>80 □ white	1001468
3200lm 4000K CRI>80 ■ black	1001473
3200lm 4000K CRI>80 □ white	1001472

ALMINO
WL, UGR<19



A-A++ Range A++-E



- Suitable for industrial areas, warehouse and logistical areas
- Efficient basic lighting with limited direct glare, UGR<19
- Extremely hard-wearing housing

Product details

220-240V ~50/60Hz | 300mA
Total consumption: 45W
Material: Steel / Polycarbonate (PC)

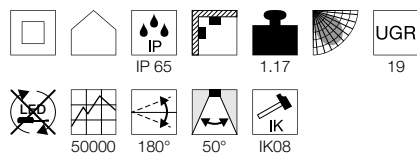

Dimensioned drawing

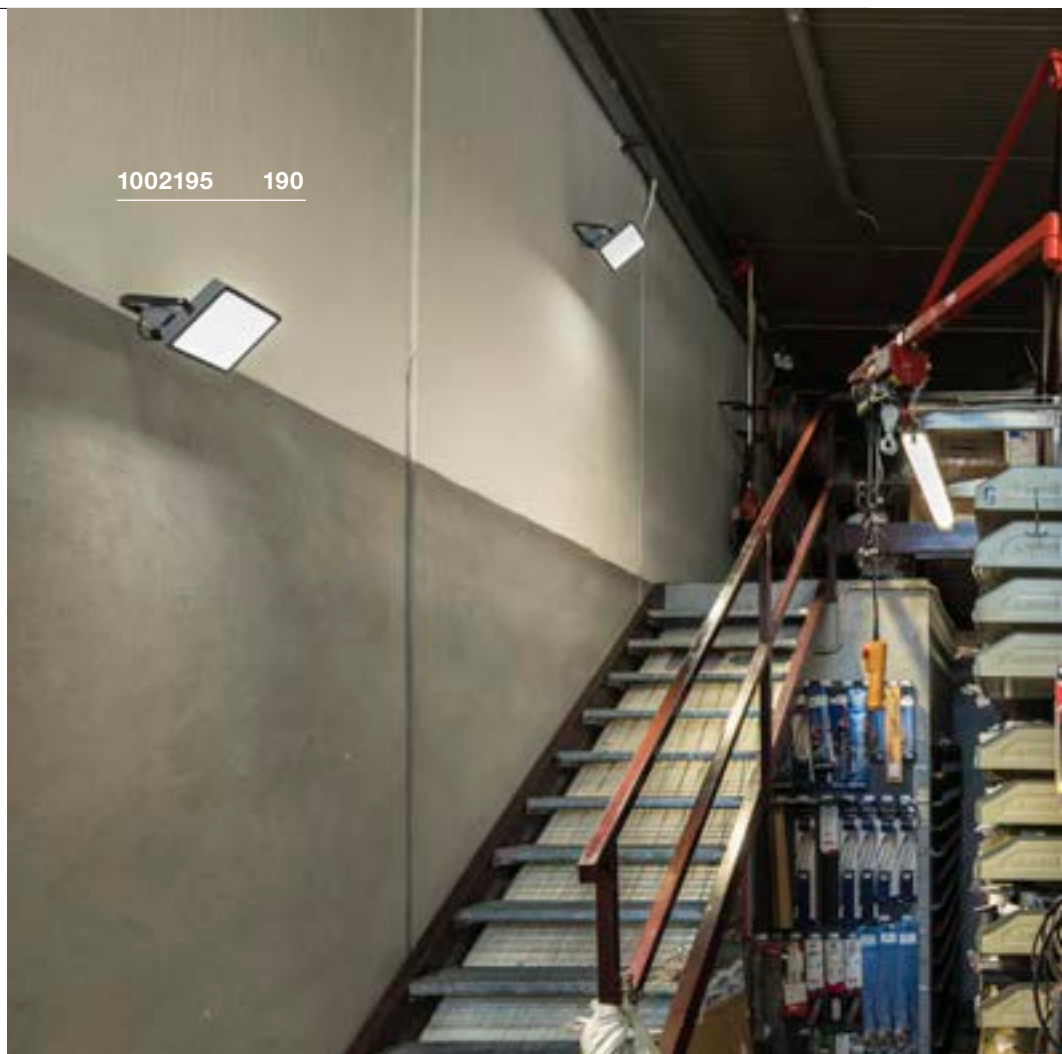
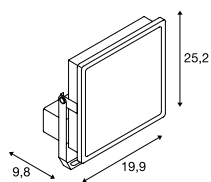

1002195 190



1002193 + 1002196 123

Variant	Item no.
6200lm 4000K CRI>80 grey / white	1002195

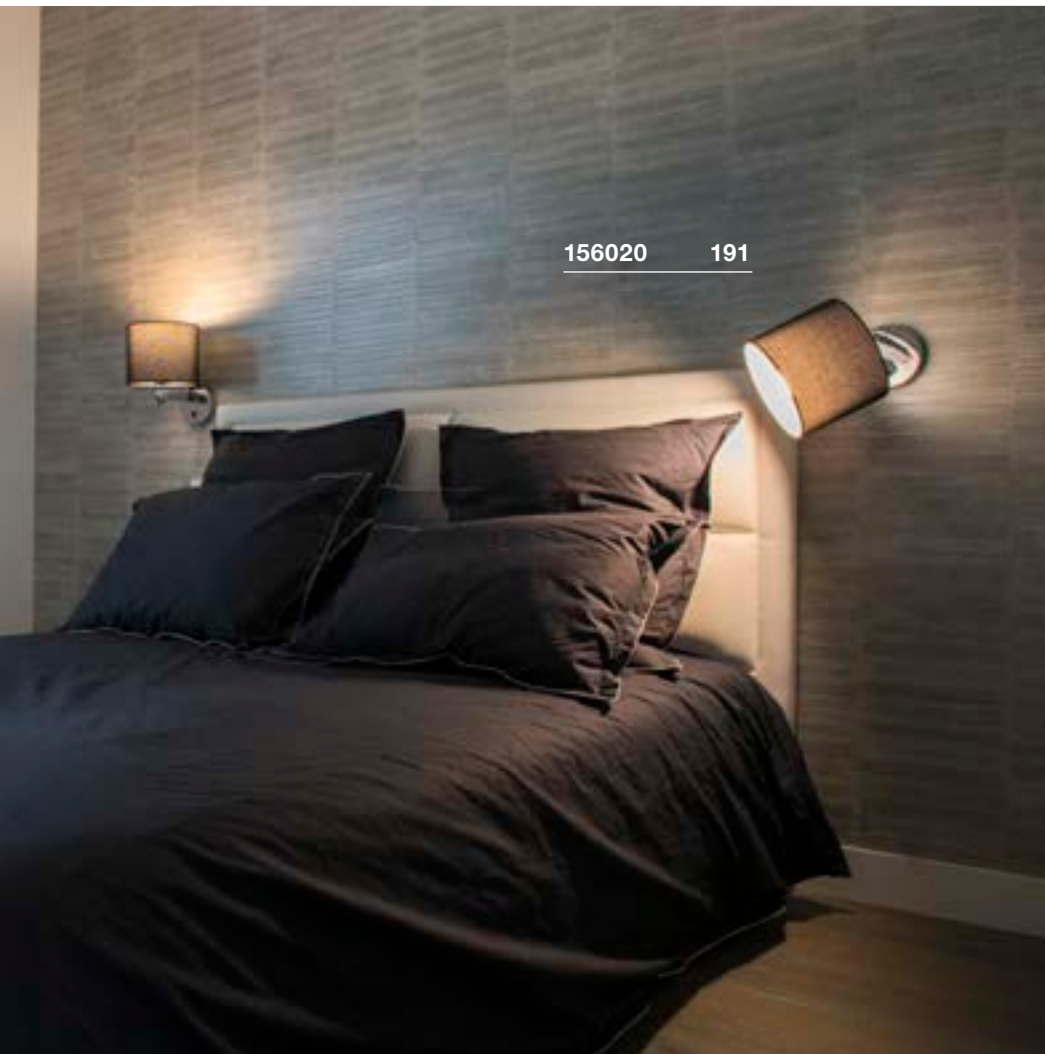

156020 191

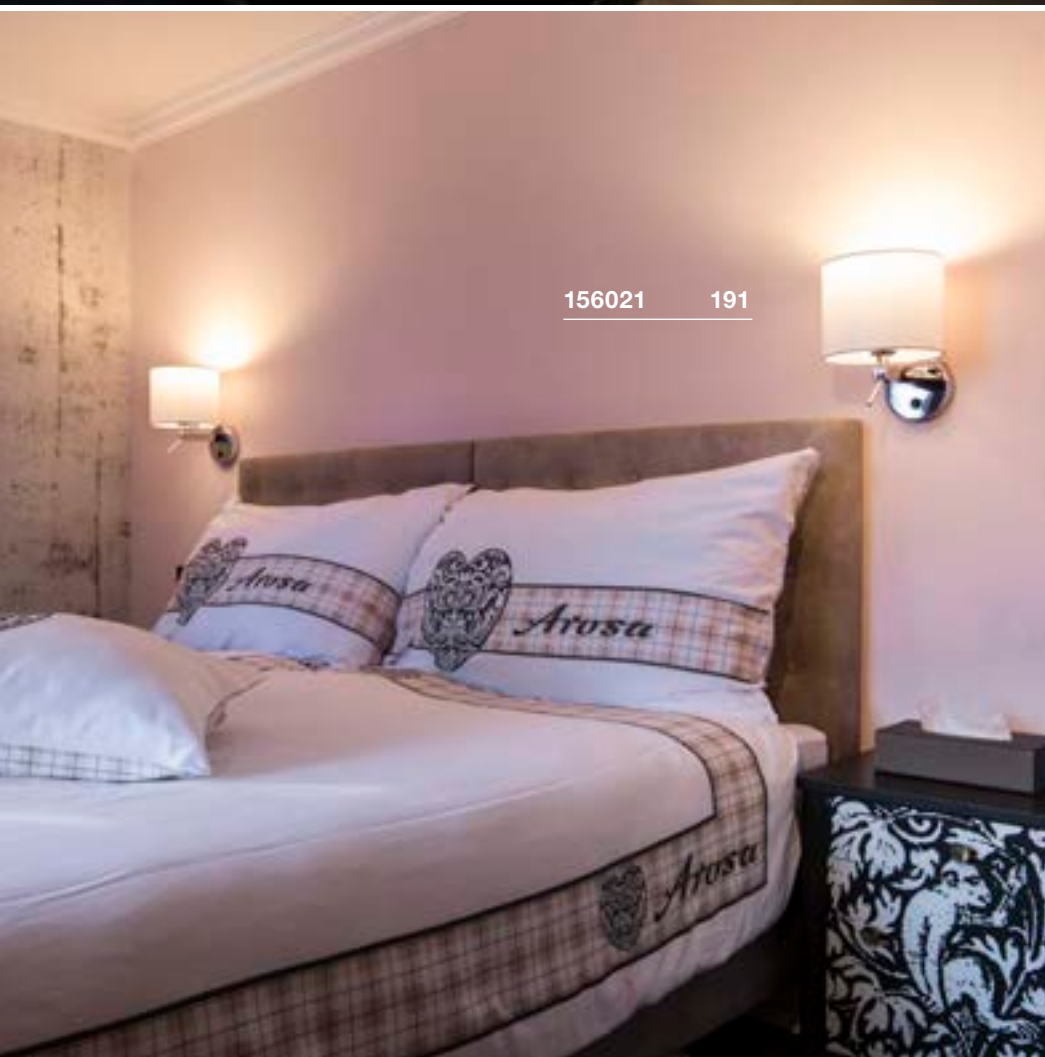

156021 191

TENORA
WL, E27

897

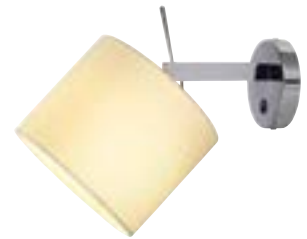
E-A++ Range
A++-E

- Rotating and swivelling wall light
- Switch at canopy

Product details

220-240V ~50/60Hz
Material: Aluminium / Textile



0.78

350°

Dimensioned drawing

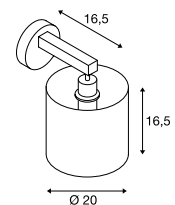

Recommended lamp

LED E27 9.1W 240°
2700K 760lm EEL=A+
10kWh/1000h
Item no. 560402



Lamp details

max. 60W

Variant	Item no.
E27	
■ black / chrome	156020
E27	
□ white	156021

FENDA
WL, basic, E27



E-A++ Range
A++-E



- Individually configurable by selecting the lamp shades

Product details

230V ~50Hz
Material: Steel

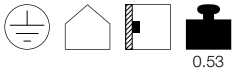

0.53

Dimensioned drawing

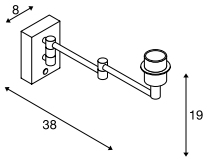

Recommended lamp

LED E27 9.1W 240°
2700K 760lm EEL=A+
10kWh/1000h
Item no. 560402



LED E27 9W 240°
2700-6500K 806lm EEL=A+
9kWh/1000h
Item no. 1001916



Lamp details

max. 40W
L: 12 cm max.

Variant	Item no.
E27	
chrome	1001449
E27	
black	1001450

FENDA
Ø 20cm, round



- Individually configurable by selecting a suitable lamp base

Product details

Material: Textile / Steel



0.19

Dimensioned drawing

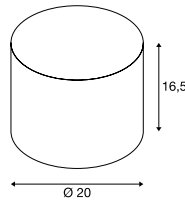

Note

max. 60W

Variant	Item no.
black	1001451
black / copper	1001452
white	1001453
beige	1001454





1001449 + 1001451 192

FENDA
WL, E27
 886
E-A++ Range
A++-E

NEW



- Individually configurable by selecting the lamp shades
- Rotating and swivelling wall light
- Switch at canopy

Product details

220-240V ~50/60Hz
Material: Steel / Aluminium



0.56 350° 90°

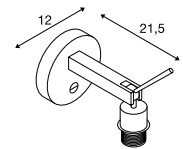

Dimensioned drawing



1003034 + 156152 193 + 46

Lamp details

max. 40W

Variant	Item no.
E27	
■ matt black	1003034 
E27	
□ matt white	1003035 

KENKUA SPOT WL, E27

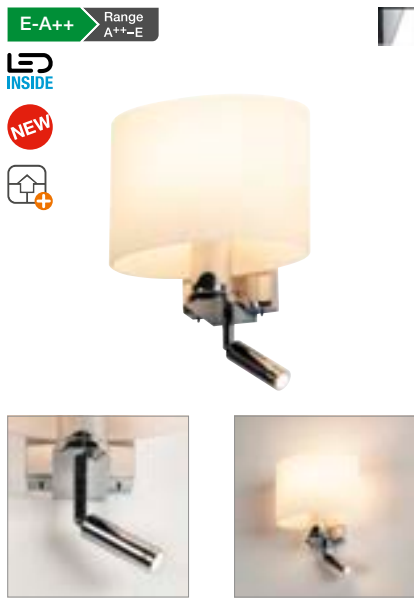

- High-quality, frosted glass
- Adjustable reading light
- Light sources can be switched separately at the canopy

Product details

100-277V ~50/60Hz | 700mA
 Material: Steel / Glass
 Product dimensions:
 W: 21.5 cm H: 25 cm D: 15.5

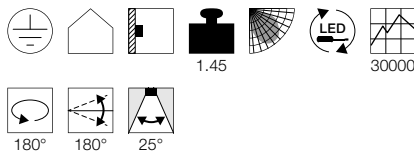

Lamp details

max. 40W

Variant	Item no.
E27 Spot: 200lm 3000K CRI>80 □ shiny chrome / opaque	1002855

KENKUA WL, E27

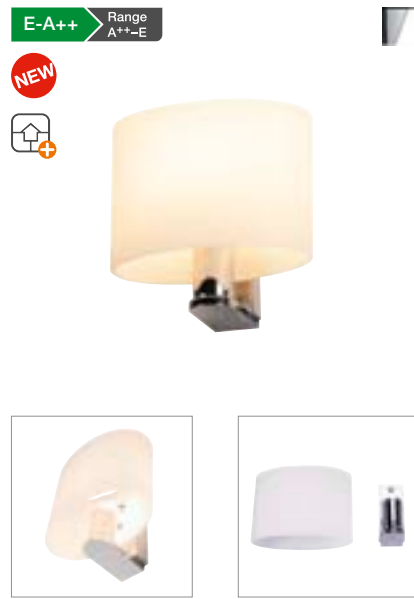

- High-quality, frosted glass

Product details

220-240V ~50/60Hz
 Material: Steel / Glass
 Product dimensions:
 W: 21.5 cm H: 20.5 cm D: 15.5

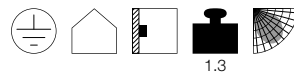

Lamp details

max. 40W

Variant	Item no.
E27 □ shiny chrome / opaque	1002856

ACCANTO SPOT SQUARE WL, E27

882



Product details

230V ~50Hz
 Material: Steel / Textile

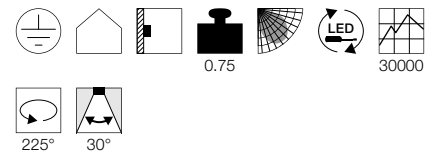

Dimensioned drawing

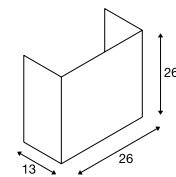

Recommended lamp

LED E27 9.1W 240°
 2700K 760lm EEL=A+
 10kWh/1000h
 Item no. **560402**



Lamp details

max. 24W
 L: 17.3 cm max.

Variant	Item no.
E27 Spot: 100lm 3000K CRI>80 ■ black	155670
E27 Spot: 100lm 3000K CRI>80 □ white	155673



155670 195

ACCANTO
WL, E27
 882
E-A++ Range
A++-E

NEW

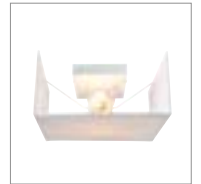

Product details

220-240V ~50/60Hz
Material: Steel / Textile



0.68

Dimensioned drawing

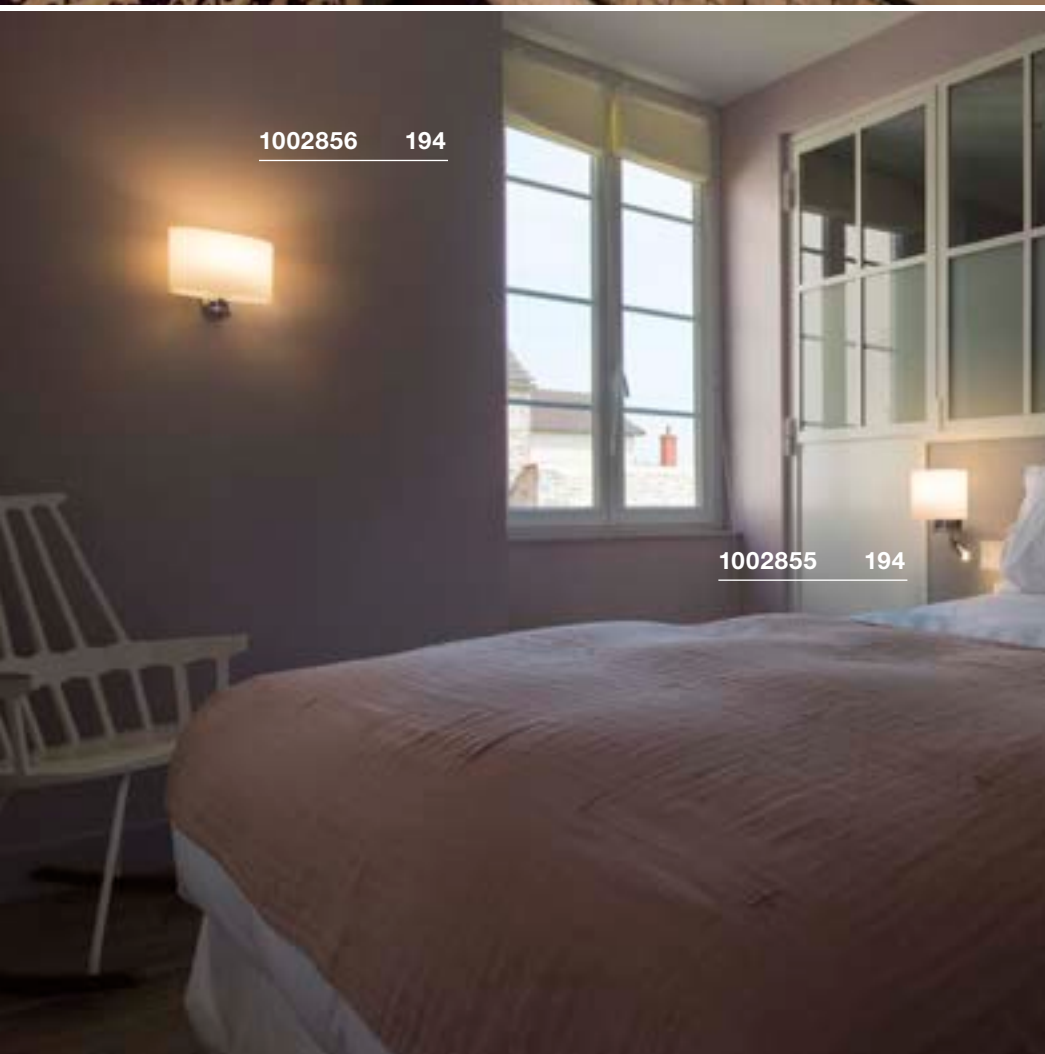
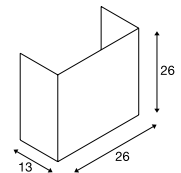

1002856 194

1002855 194

Lamp details

max. 40W

Variant	Item no.
E27	
■ black	1002942
E27	
□ white	1002943

COUPA FLEX WL

D-A++ Range
A++-E

LED
INSIDE



- Light sources can be switched separately
- Switch at canopy

Product details

230V ~50Hz
Total consumption: 4.8W
Material: Steel / Glass



1.3

30000



30°

Dimensioned drawing

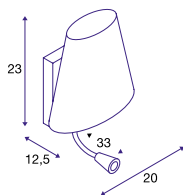

Recommended lamp

G9 2.7W
2600K 250lm EEL=A+
3kWh/1000h
Item no. 560302



LED G9 2.5W
2700K 180lm EEL=A+
3kWh/1000h
Item no. 1002131



Lamp details

max. 40W QT14
L: 9 cm max.

Variant	Item no.
G9 QT14 Spot: 125lm 3000K CRI>80 chrome / white	149452

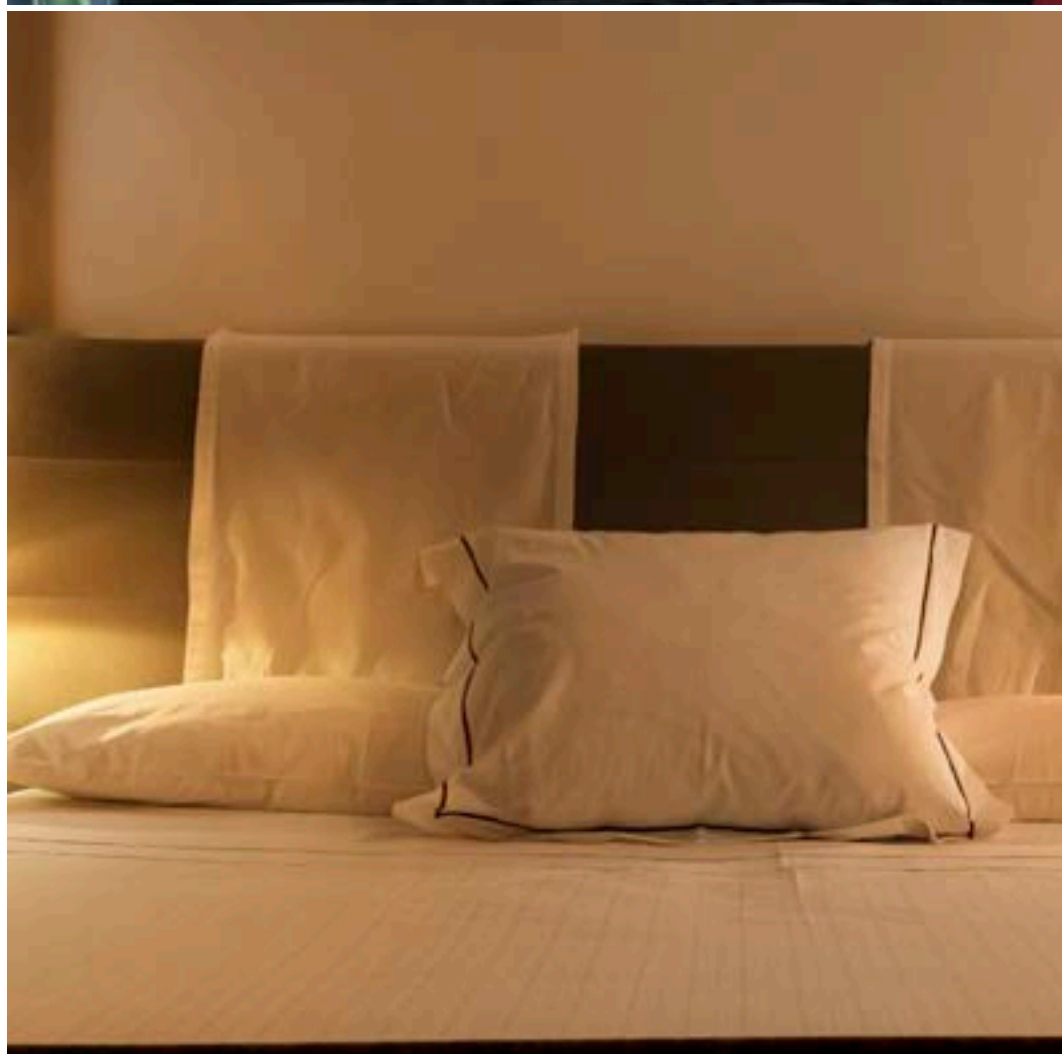

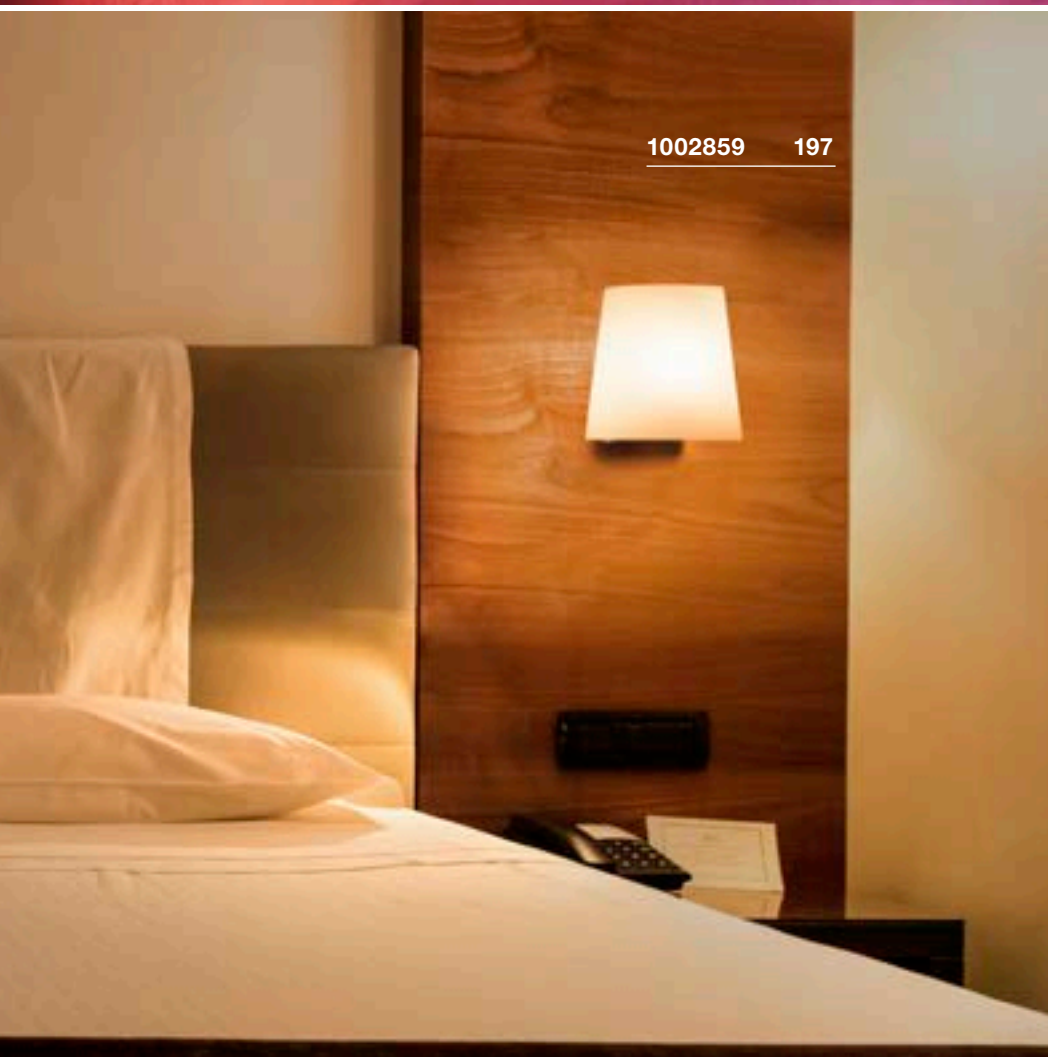

1002859 197

COUPA WL, QT14

D-A+ Range
A++-E

NEW

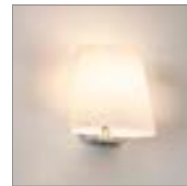

- High-quality, frosted glass

Product details

220-240V ~50/60Hz
Material: Steel / Glass

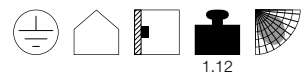

Dimensioned drawing

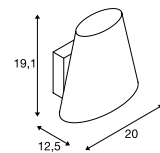

Recommended lamp

G9 2.7W
2600K 250lm EEL=A+
3kWh/1000h
Item no. 560302

LED G9 2.5W
2700K 180lm EEL=A+
3kWh/1000h
Item no. 1002131



Lamp details

max. 42W QT14
L: 9 cm max.

Variant	Item no.
G9 QT14 chrome / white	1002859

MANA
WL, basic



891

A-A++ Range
A++-E



- Premium LED with CRI>90
- With adjustable reading light, light sources can be switched separately

Product details

100-240V ~50/60Hz | 320mA/500mA
Total consumption: 11W
Material: Aluminium / Steel



0.7

30000

30°

Dimensioned drawing

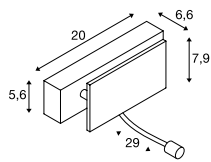

1000615 + 1000629 198 + 199

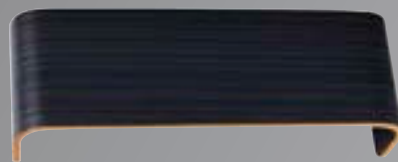

Variant	Item no.
Flood: 490lm 3000K CRI>90 Spot: 80lm 3000K CRI>90	
white / chrome	1000615

MANA
Shade



MANA
Shade



MANA
Shade



- Can be individually designed with colours, stickers and more

Product details

Material: Plaster / Steel



Dimensioned drawing

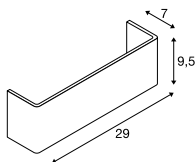

Note

Only suitable for 1000614/1000615



Dimensioned drawing

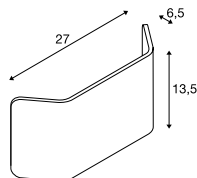

Note

Only suitable for 1000614/1000615



0.93

Dimensioned drawing

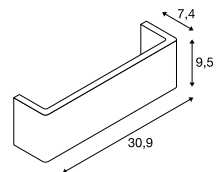

Note

Only suitable for 1000614/1000615

Variant	Item no.
Wood 0.16 kg	
■ grey / brown	1000621
Aluminium 0.39 kg	
□ white	1000623
Aluminium 0.39 kg	
■ aluminium	1000624

Variant	Item no.
Wood 0.2 kg	
■ grey / brown	1000626
Aluminium 0.47 kg	
□ white	1000628
Aluminium 0.47 kg	
■ aluminium	1000629

Variant	Item no.
□ white	1000825

NAPIA
WL

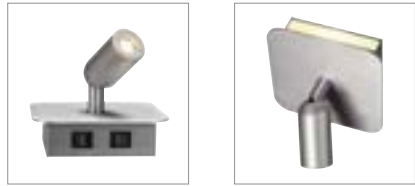

- Direct and indirect lighting
- Light sources can be switched separately

Product details

220-240V ~50/60Hz | 350mA
Total consumption: 3.8W
Material: Aluminium

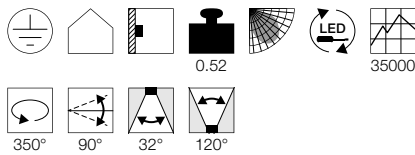

Dimensioned drawing

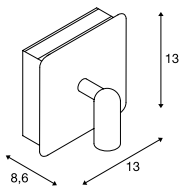

NAPIA TWIN
WL

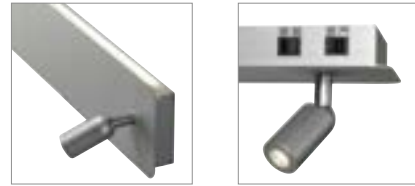

- Direct and indirect lighting
- Light sources can be switched separately

Product details

220-240V ~50/60Hz
Total consumption: 21W
Material: Aluminium

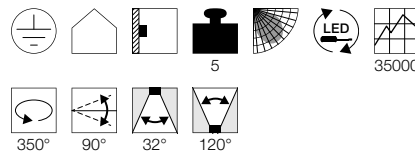

Dimensioned drawing

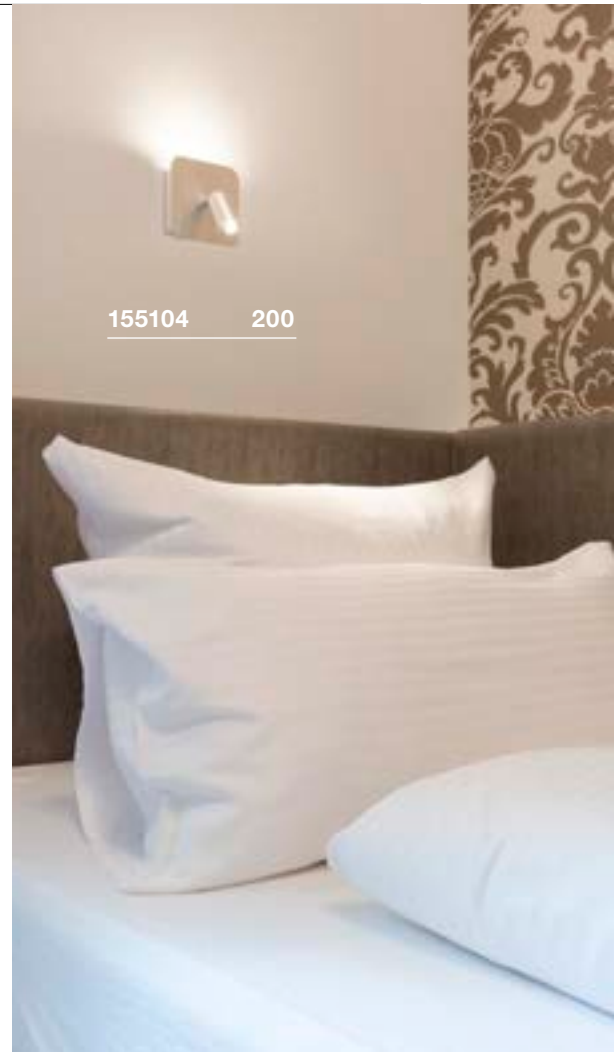
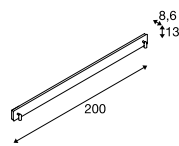

155104 200



155100 200

Variant	Item no.
Direct: 95lm 3000K CRI>80 Indirect: 62lm 3000K CRI>80 ■ black	155100
Direct: 95lm 3000K CRI>80 Indirect: 62lm 3000K CRI>80 □ white	155101
Direct: 95lm 3000K CRI>80 Indirect: 62lm 3000K CRI>80 ■ matt aluminium	155104

Variant	Item no.
Direct: 95lm 3000K CRI>80 Indirect: 470lm 3000K CRI>80 □ white	1001822
Direct: 95lm 3000K CRI>80 Indirect: 470lm 3000K CRI>80 ■ matt aluminium	155114



155100 200

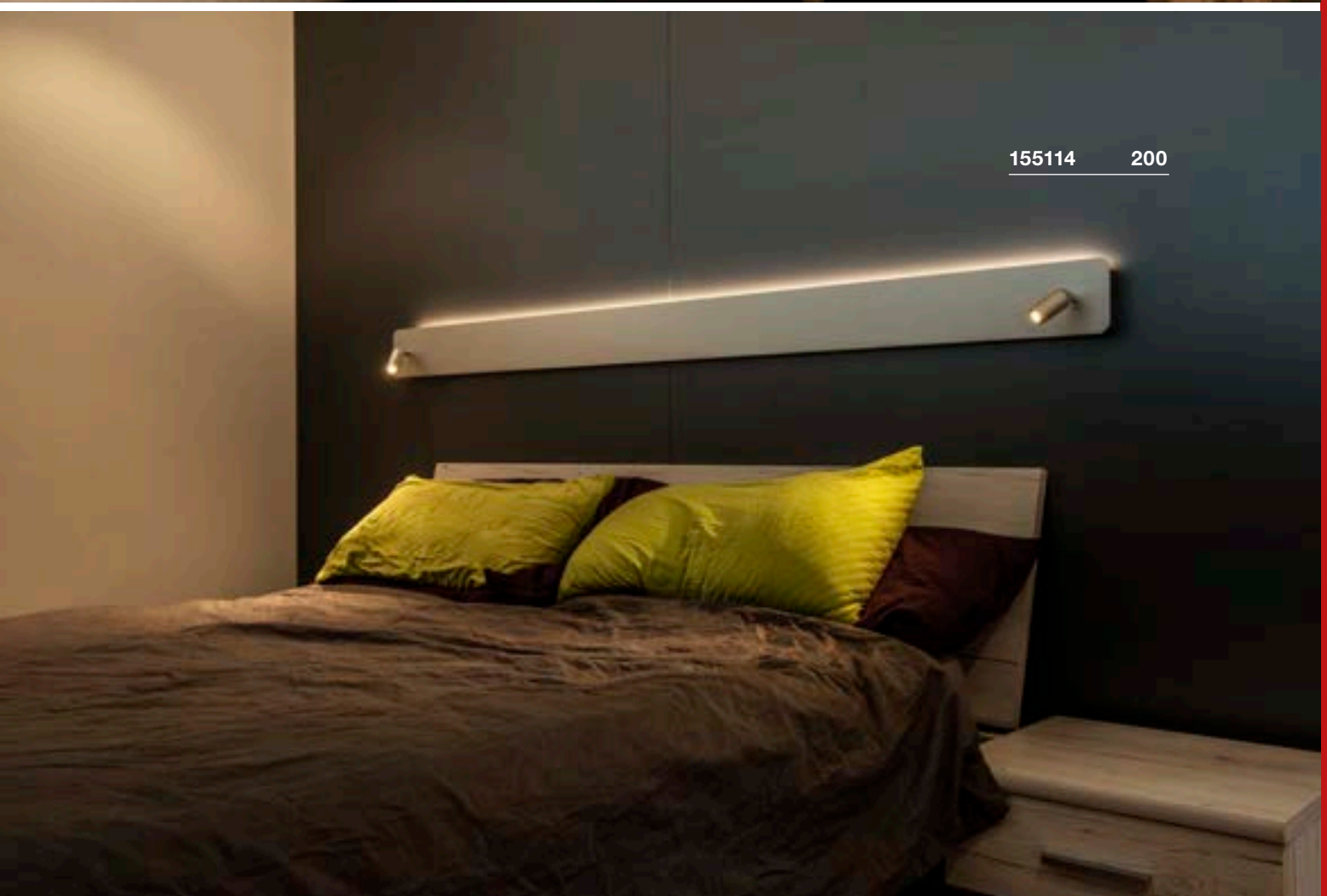

155114 200

1000326 202

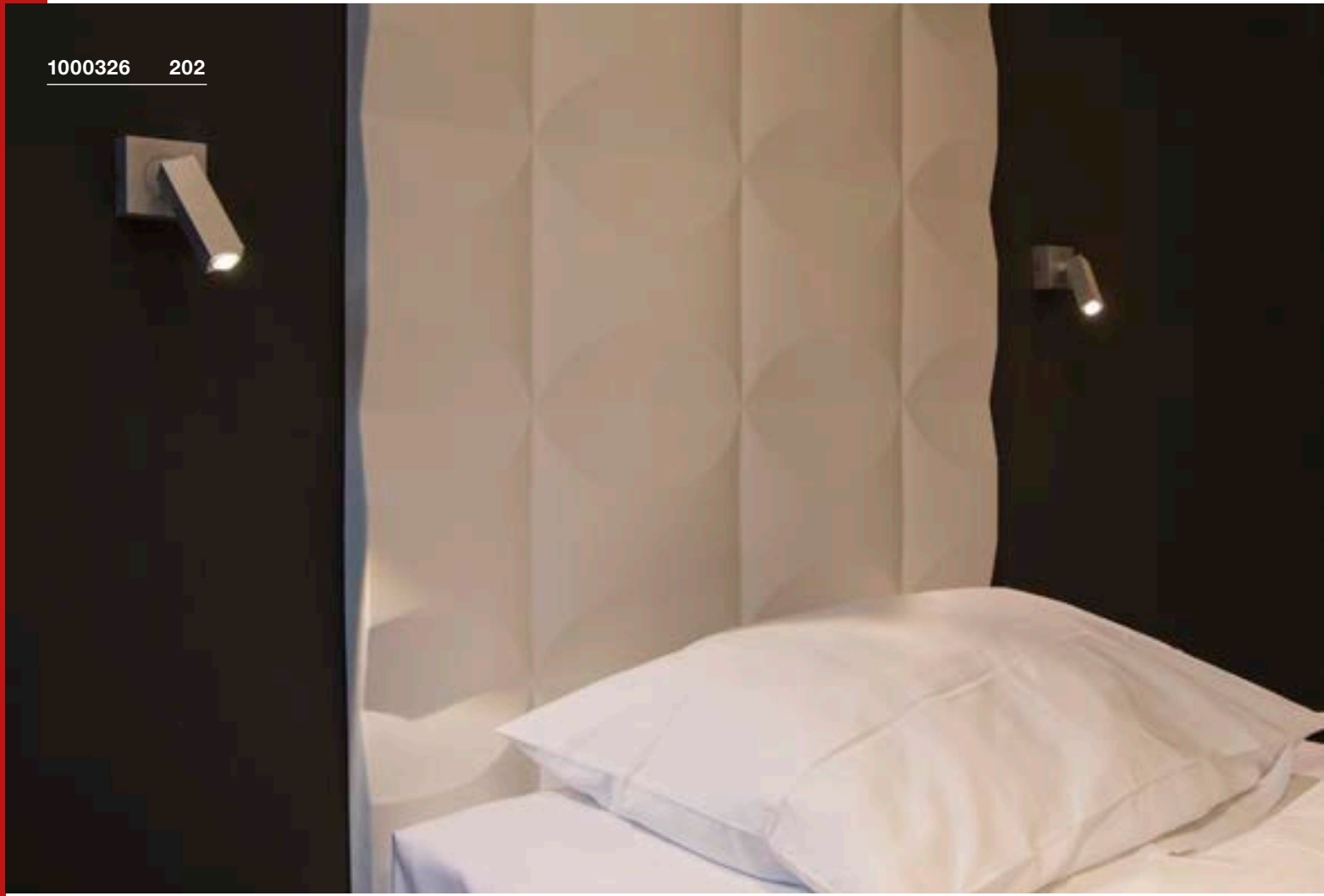

148540 202

STIX
WL

A-A++ Range A++-E



- Rotating and swivelling lamp head
- Switch at canopy

Product details

100-240V ~50/60Hz | 700mA
Total consumption: 4.5W
Material: Aluminium

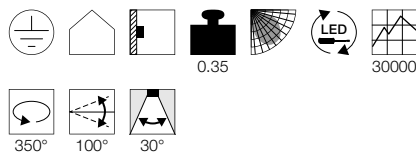

Dimensioned drawing

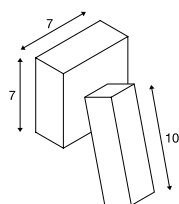

Variant	Item no.
185lm 3000K CRI80	
■ black	1000324
185lm 3000K CRI80	
□ white	1000325
185lm 3000K CRI80	
■ grey	1000326

PHELIA
WL, QPAR51

E-A++ Range A++-E



893



- Switch on the lamp head
- Lampshade interior lacquered in white

Product details

230V ~50/60Hz
Material: Aluminium / Steel

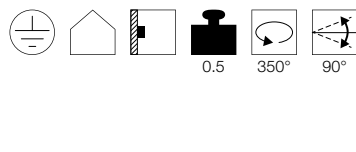

Dimensioned drawing

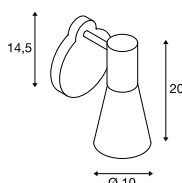

Recommended lamp

LED GU10 5.5W 38°
2700K 400lm EEL=A+
6kWh/1000h
Item no. 1001030



LED GU10 7.2W 36°
2700K 470lm EEL=A+
8kWh/1000h
Item no. 560542



Lamp details

max. 35W QPAR51
Ø: 5 cm max. L: 10.5 cm max.

Variant	Item no.
GU10 QPAR51	
■ black	148540

PHELIA
WL, QPAR51

E-A++ Range A++-E



893



- Lampshade interior lacquered in white

Product details

230V ~50/60Hz
Material: Aluminium / Steel

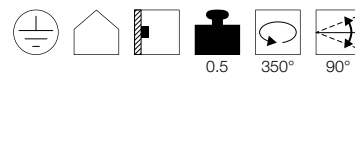

Dimensioned drawing

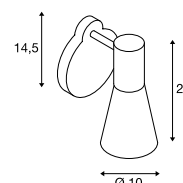

Recommended lamp

LED GU10 5.5W 38°
2700K 400lm EEL=A+
6kWh/1000h
Item no. 1001030



LED GU10 7.2W 36°
2700K 470lm EEL=A+
8kWh/1000h
Item no. 560542



Lamp details

max. 35W QPAR51
Ø: 5 cm max. L: 10.5 cm max.

Variant	Item no.
GU10 QPAR51	
□ white	1002122

ENOLA B
WL, QPAR51



E-A++ Range A++-E



- Switch at canopy

Product details

230V ~50Hz
Material: Aluminium / Steel

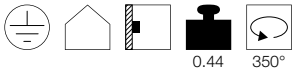

0.44 350°

Dimensioned drawing

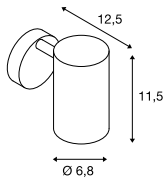

Recommended accessories

■ Deco ring
Item no. 151840



Recommended lamp

LED GU10 5.5W 38°
2700K 400lm EEL=A+
6kWh/1000h
Item no. 1001030



LED GU10 5.1W 48°
2700-6500K 350lm EEL=A+
6kWh/1000h
Item no. 1001918



Lamp details

max. 50W QPAR51
L: 6 cm max.

Variant	Item no.
GU10 QPAR51	
■ black	1000729
GU10 QPAR51	
□ white	1000730
GU10 QPAR51	
■ gold	1000731
GU10 QPAR51	
■ grey	1000732



1000731 204





152341 205



1002140 205

KARPO 30
CW, single



A-A++ Range A++-E



- Premium LED with CRI>90
- Switch at canopy

Product details

100-240V ~50/60Hz | 500mA
Total consumption: 6W
Material: Aluminium / Steel

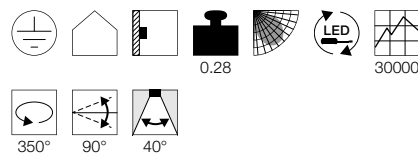

Dimensioned drawing

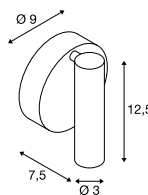

KARPO
WL



A-A++ Range A++-E



- Premium LED with CRI>90
- 3 step dimming
- 2 USB connections (max. load 1.5A)

Product details

220-240V ~50/60Hz | 500mA
Total consumption: 6.6W
Dimmable: Switch

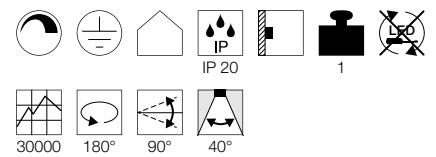

Dimensioned drawing

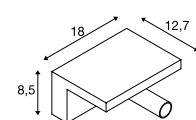

Variant	Item no.
330lm 3000K CRI>90	
■ black	152340
380lm 3000K CRI>90	
□ white	152341
360lm 3000K CRI>90	
■ gold	1002173

Variant	Item no.
390lm 3000K CRI>90	
□ white	1002140

146700 206

PIPOFLEX
WL

A-A++ Range
A++-E



- Switch at canopy

Product details

220-240V ~50/60Hz | 266mA
Total consumption: 4.6W
Material: Aluminium



Dimensioned drawing

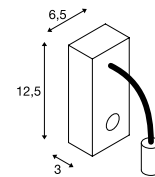

Variant	Item no.
200lm 3000K CRI>80	
■ black	146700
200lm 3000K CRI>80	
□ white	146701
200lm 3000K CRI>80	
■ grey	146704



1002607 207

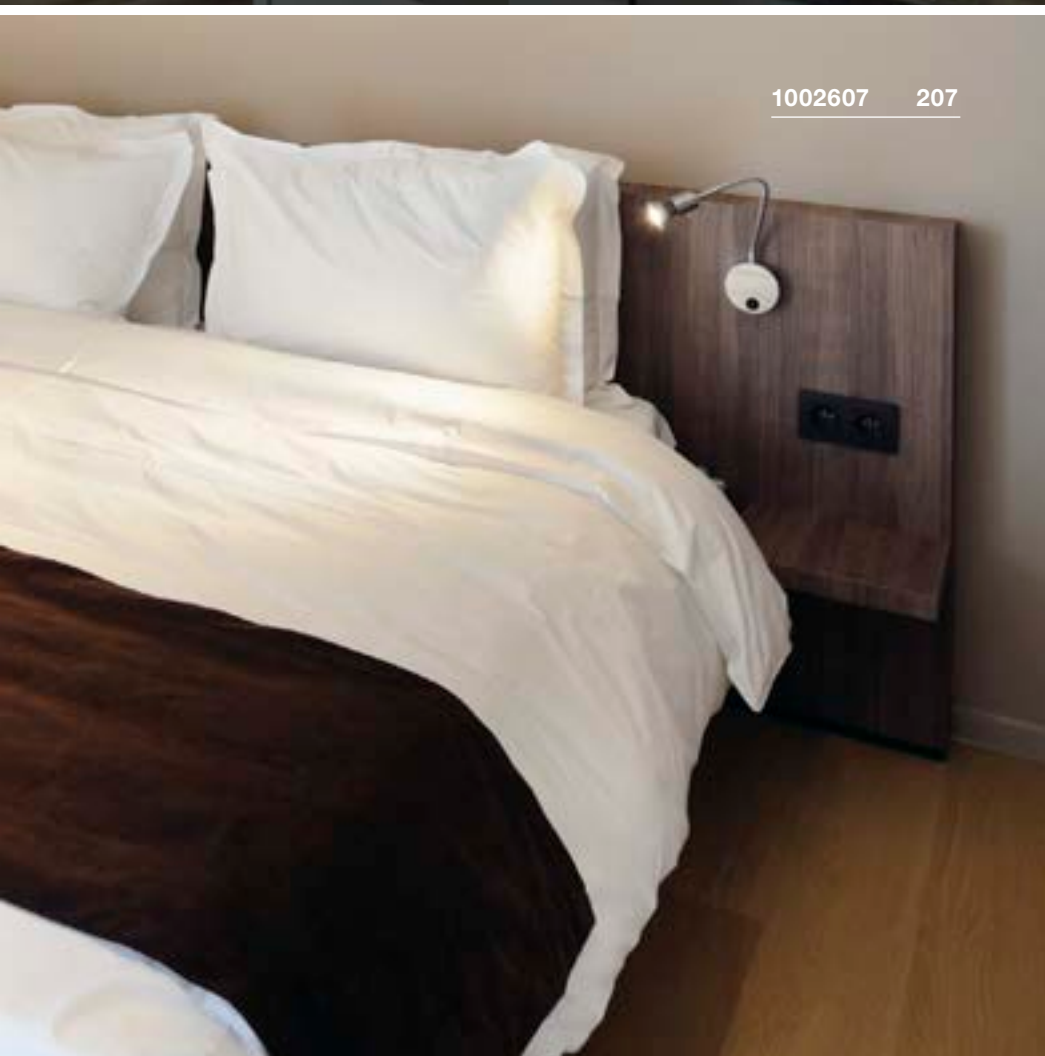

1002607 207

DIO FLEX PLATE WL QPAR51

E-A++ Range
A++-E



NEW
COLOR



- Switch at canopy

Product details

230V ~50Hz
Material: Aluminium

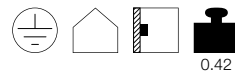

0.42

Dimensioned drawing

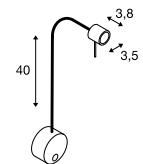

Recommended accessories

■ Lamp deco ring diam. 5.7cm
Item no. 151040



Recommended lamp

LED GU10 7.2W 36°
2700K 520lm EEL=A+
8kWh/1000h
Item no. 1001560



LED GU10 7.2W 36°
3000K 520lm EEL=A+
8kWh/1000h
Item no. 1001562



Lamp details

max. 50W QPAR51

Variant	Item no.
GU10 QPAR51 □ white	1002607
GU10 QPAR51 ■ black	1002608
GU10 QPAR51 ■ chrome	146692

DIO FLEX PLATE
WL



- Switch at canopy

Product details

100-240V ~50/60Hz | 320mA
Total consumption: 1.9W
Material: Aluminium

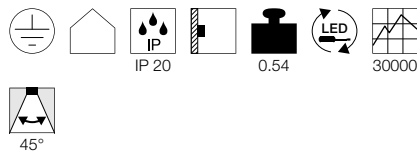

Dimensioned drawing

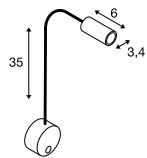

Variant	Item no.
82lm 2700K CRI>80 □ white	1002117
82lm 2700K CRI>80 ■ chrome	1002116
82lm 2700K CRI>80 ■ black	1002430
82lm 3000K CRI>80 □ white	1002118
82lm 3000K CRI>80 ■ chrome	146682
82lm 3000K CRI>80 ■ black	1002431
82lm 4000K CRI>80 □ white	1002119
82lm 4000K CRI>80 ■ chrome	146680
82lm 4000K CRI>80 ■ black	1002432



1002117 208



1002431 208



IVED GOOSE WL, canopy

A-A++ Range
A++-E

LED
INSIDE



146512 209

Product details

100-240V ~50/60Hz | 350mA
Total consumption: 2.2W
Material: Aluminium



Dimensioned drawing

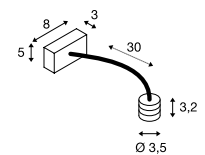

Variant	Item no.
80lm 3000K CRI>80 ■ grey	146512

MAGANDA
WL



A-A++ Range A++-E

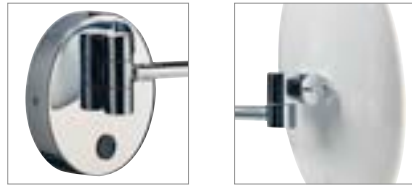

- Illuminated outer edge
- Switch at canopy
- 3-times optical magnificatio

Product details

100-240V ~50/60Hz | 12V DC
Total consumption: 4.2W
Material: Steel / Glass

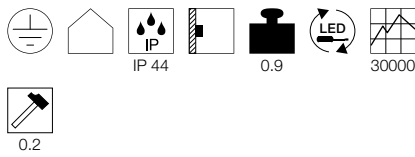

Dimensioned drawing

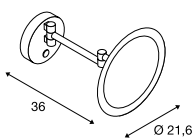

VISSARDO
WL

A-A++ Range A++-E



- Switch at canopy
- 3-times optical magnificatio

Product details

100-240V ~50/60Hz
Total consumption: 5.8W
Material: Steel / Glass

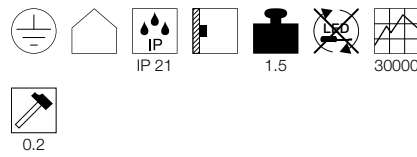

Dimensioned drawing

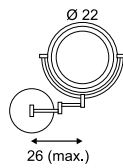

1001503 210



149772 211



Variant	Item no.
70lm 3000K CRI>80 ■ chrome / transparent	1001503

Variant	Item no.
130lm 3000K CRI>80 ■ chrome	149782



TRUKKO
WL

A-A++ Range A++-E



Product details

100-240V ~50/60Hz | 700mA
Total consumption: 9W

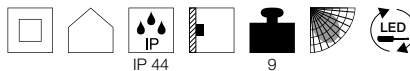

Dimensioned drawing

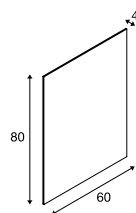

Variant	Item no.
250lm 3000K CRI>80 □ transparent	149752

TRUKKO 60/90
WL

A-A++ Range A++-E



Product details

100-240V ~50/60Hz | 500mA
Material: Steel / Plastic

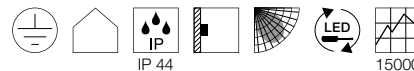

15000

Dimensioned drawing

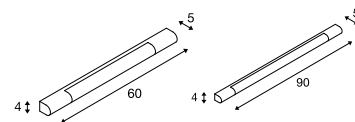

Variant	Item no.
450lm 8.8W 3000K CRI>80 H: 60 cm 0.75 kg	149762
710lm 11.4W 3000K CRI>80 H: 90 cm 0.8 kg	149772



MARYLIN
WL

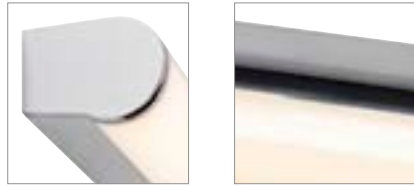

Product details

220-240V ~50/60Hz | 600mA
Material: Aluminium / Polycarbonate (PC)

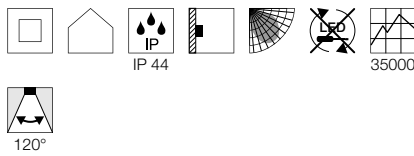

Dimensioned drawing

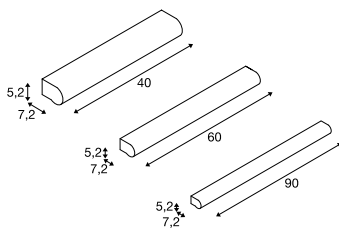

Variant	Item no.
800lm 10W 3000K CRI>80 L: 40 cm 0.85 kg chrome / white	1002190
1200lm 15W 3000K CRI>80 L: 60 cm 1.12 kg chrome / white	1002191
1700lm 21W 3000K CRI>80 L: 90 cm 1.64 kg chrome / white	1002192

DEVIN
WL, double



- Elegant aluminium and glass combination

Product details

220-240V ~50/60Hz
Total consumption: 16W
Material: Steel / Glass
Dimmable: Triac C, Triac L

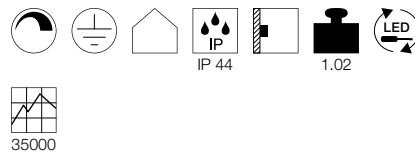

Dimensioned drawing

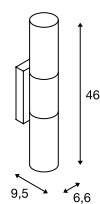

Variant	Item no.
890lm 3000K CRI>80 chrome / white	151553

1002191 212



151553 212



WL 106
E14

E-A++ Range
A++-E



Product details

220-240V ~50/60Hz
Material: Aluminium / Glass



Dimensioned drawing

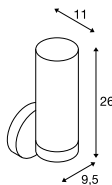

Recommended lamp

LED E14 6.5W 280°
3000K 480lm EEL=A+
7kWh/1000h
Item no. 560372



LED E14 4W
2700K 250lm EEL=A+
4kWh/1000h
Item no. 560222



Lamp details

max. 40W
Ø: 3.6 cm max. L: 11 cm max.

Variant	Item no.
chrome	1002228

WL 106
E14

E-A++ Range
A++-E



Product details

220-240V ~50/60Hz
Material: Aluminium / Glass

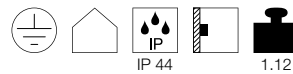

Dimensioned drawing

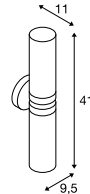

Recommended lamp

E14 4W
2700K 250lm EEL=A+
4kWh/1000h
Item no. 560222



Lamp details

2x max. 40W
Ø: 3.6 cm max. L: 11 cm max.

Variant	Item no.
chrome	1002229





151282 214

MIBO UP/DOWN
WL, QT14D-A+ Range
A++-E

Product details

220-240V ~50/60Hz
Material: Aluminium / Glass

IP 21

0.4

Dimensioned drawing

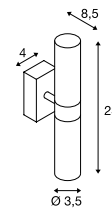

Recommended lamp

G9 2.5W
2700K 180lm EEL=A+
3kWh/1000h
Item no. 560302LED G9 3.5W
2800K 300lm EEL=A+
4kWh/1000h
Item no. 1002131

Lamp details

2x max. 25W QT14

Variant	Item no.
G9 QT14	
■ chrome	151282

DORISA 30

A-A++ Range A++-E



• Convertible by removing the vanity light bracket

Product details

220-240V ~50/60Hz | 340mA
 Total consumption: 5.2W
 Material: Aluminium / Plastic

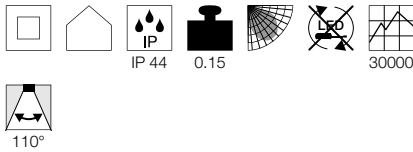

Dimensioned drawing

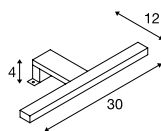

Note

Clamping range: 0-6 mm

Variant	Item no.
280lm 4000K CRI>80	
chrome	1000777
280lm 4000K CRI>80	
matt grey	1000778

DORISA 50

A-A++ Range A++-E



• Convertible by removing the vanity light bracket

Product details

220-240V ~50/60Hz | 340mA
 Total consumption: 6.6W
 Material: Aluminium / Plastic

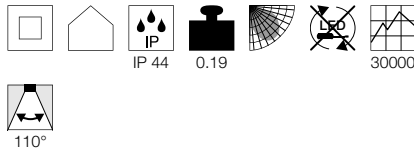

Dimensioned drawing

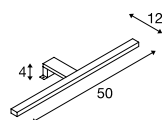

Note

Clamping range: 0-6 mm

Variant	Item no.
370lm 4000K CRI>80	
chrome	1000780
370lm 4000K CRI>80	
matt grey	1000781



DORISA 20
square

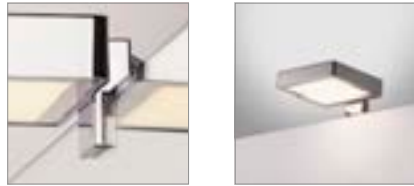

• Convertible by removing the vanity light bracket

Product details

220-240V ~50/60Hz | 340mA
Total consumption: 5.5W
Material: Aluminium / Plastic

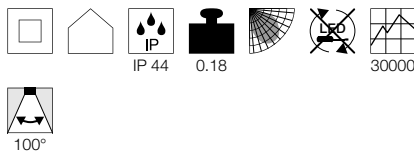

Dimensioned drawing

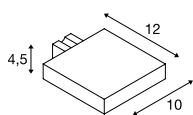

Note

Clamping range: 0-6 mm

DORISA 40
rectangular



• Convertible by removing the vanity light bracket

Product details

220-240V ~50/60Hz | 340mA
Total consumption: 6.6W
Material: Aluminium / Plastic

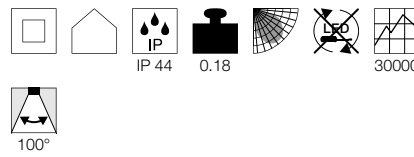

Dimensioned drawing

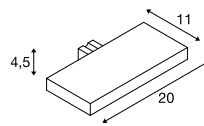

Note

Clamping range: 0-6 mm

Variant	Item no.
230lm 4000K CRI>80 ■ chrome	1000816

Variant	Item no.
310lm 4000K CRI>80 ■ chrome	1000818

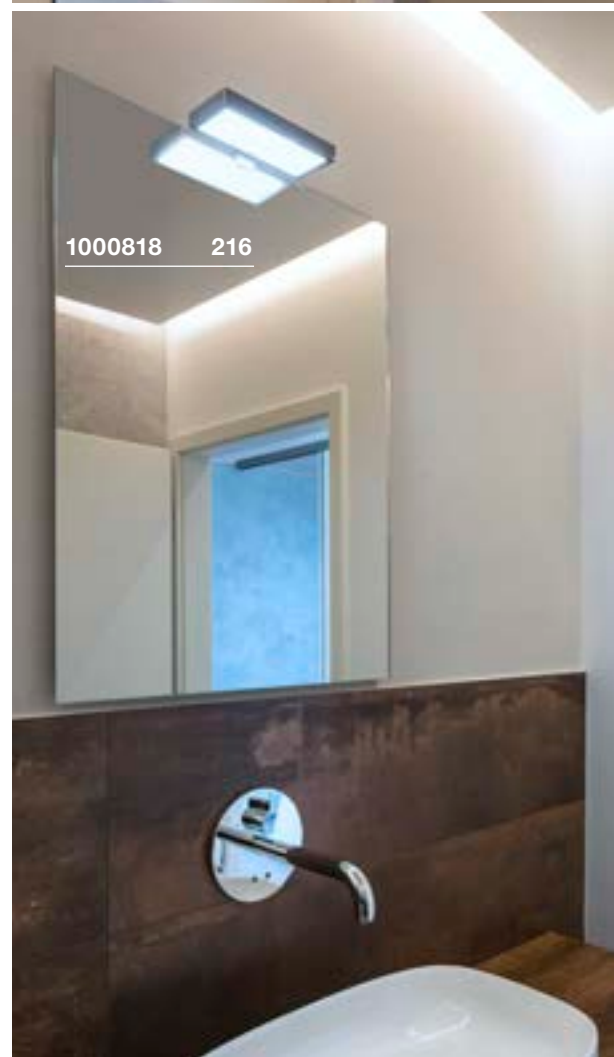



1000816 216



BATHROOM LIGHT HIGHLIGHTS.

OUR PERFECT LIGHT IN THE BATHROOM.



1000669 221



GLENOS® 60 | 219



L-LINE 60 | 220



L-LINE 120 | 220



Q-LINE® | 221

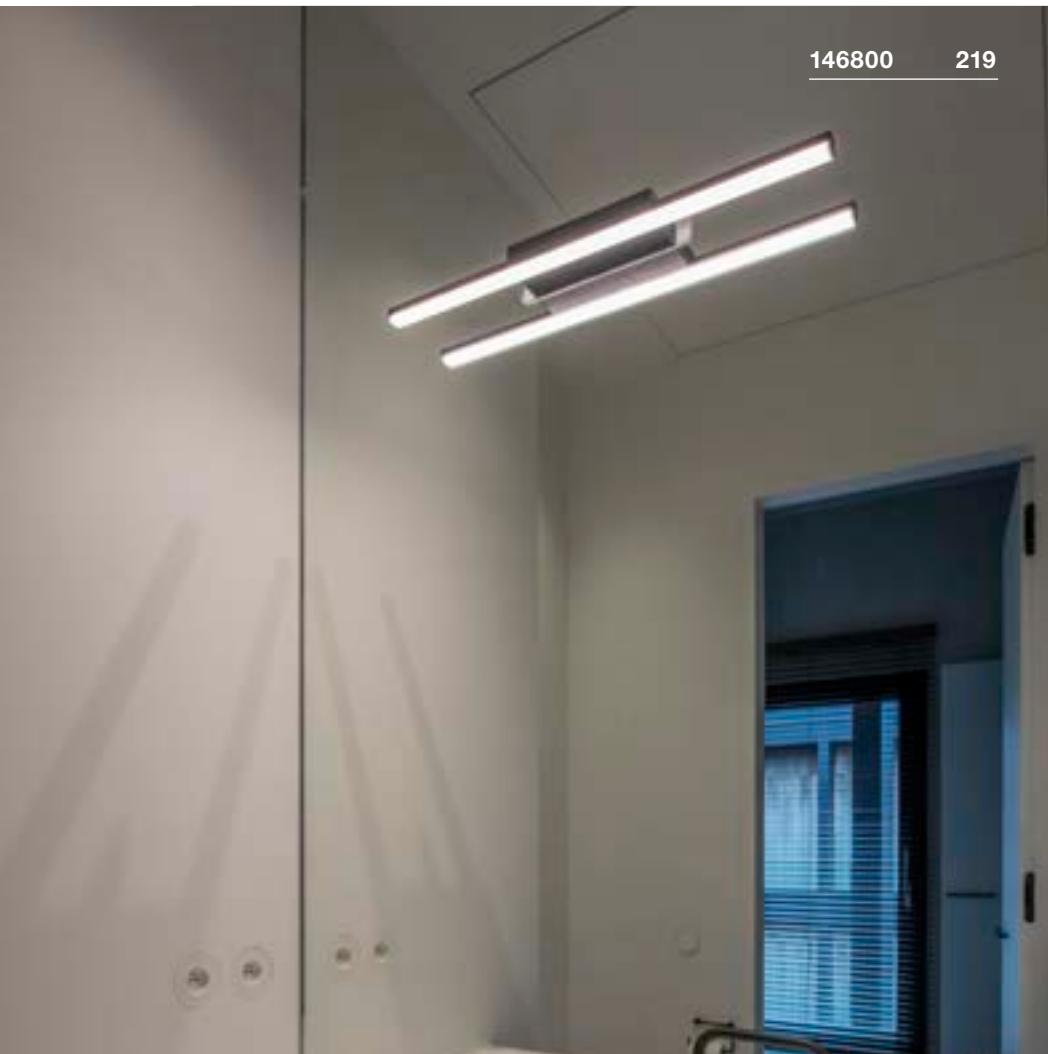

146800 219

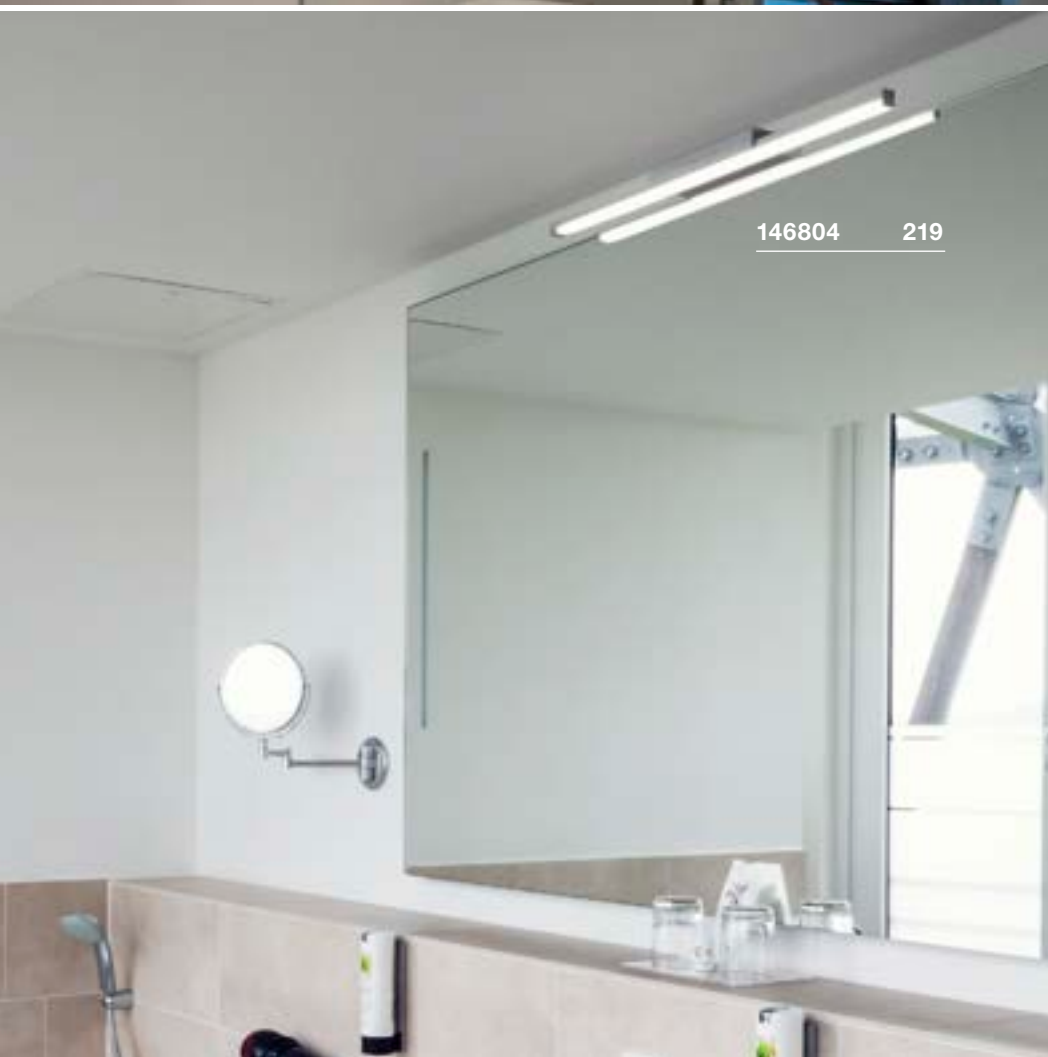

146804 219

GLENOS® 60

A-A++ Range A++-E



LED INSIDE

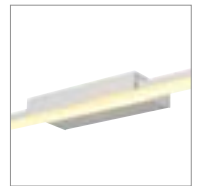
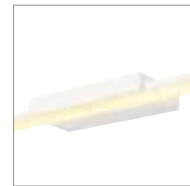

Product details

100-240V ~50/60Hz | 24V DC
 Total consumption: 17W
 Material: Aluminium / Acrylic

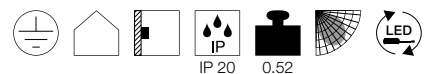

Dimensioned drawing

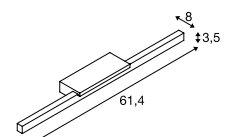

Variant	Item no.
1000lm 3000K CRI>80	
■ black	146800
1000lm 3000K CRI>80	
□ white	146801
1000lm 3000K CRI>80	
■ grey	146804

L-LINE 60



L-LINE 120



Product details

220-240V ~50/60Hz | 350mA
 Total consumption: 10W
 Material: Aluminium / Polycarbonate (PC)

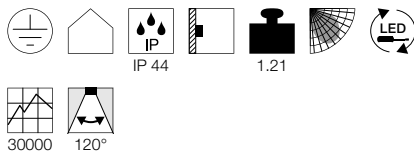

Product details

220-240V ~50/60Hz | 350mA
 Total consumption: 18.5W
 Material: Aluminium / Polycarbonate (PC)

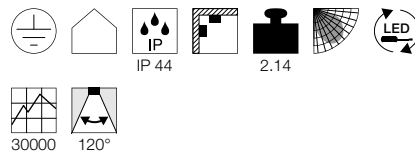

Dimensioned drawing

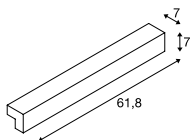

Dimensioned drawing

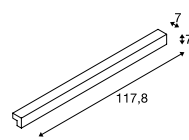

Variant	Item no.
820lm 3000K CRI>80 □ white	1001299
820lm 3000K CRI>80 ■ matt silver	1001300
820lm 3000K CRI>80 ■ grey	1001301

Variant	Item no.
1650lm 3000K CRI>80 □ white	1001303
1650lm 3000K CRI>80 ■ matt silver	1001304
1650lm 3000K CRI>80 ■ grey	1001305

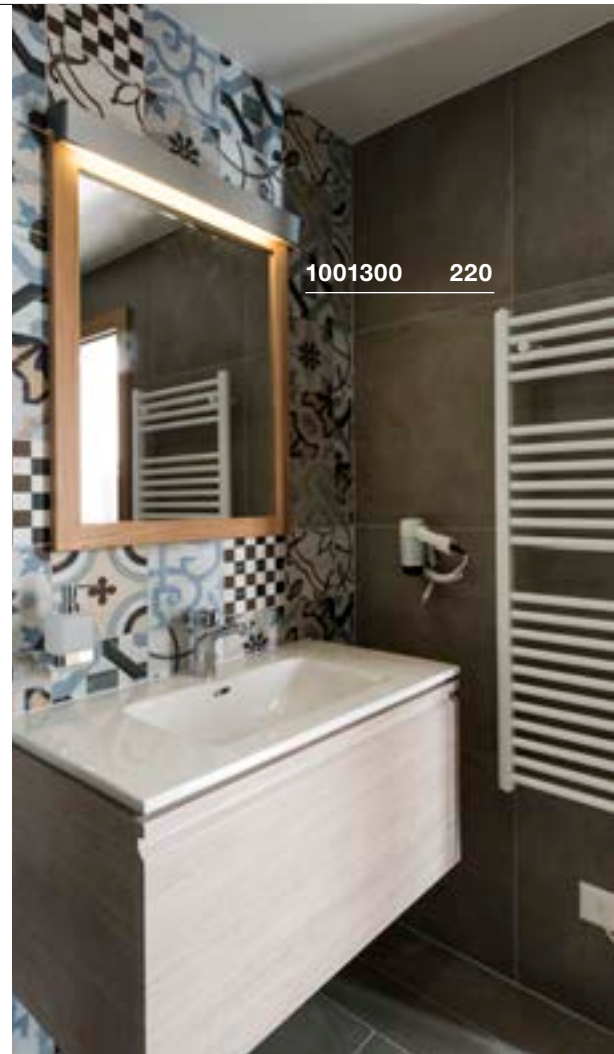

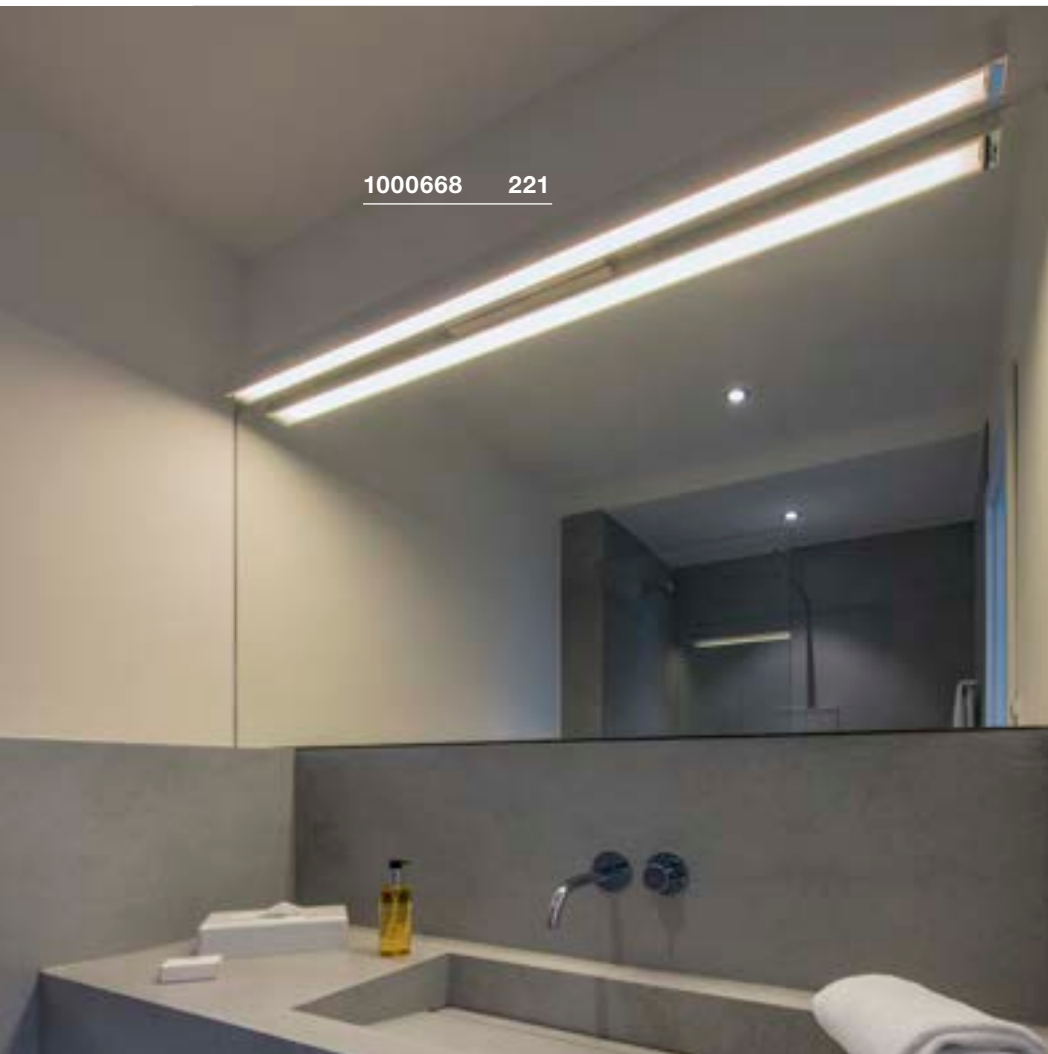

1000668 221



1000670 221

Q-LINE®
WL

894

A-A++ Range A++-E

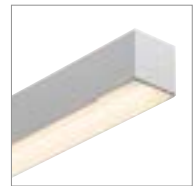

Product details

220-240V ~50/60Hz | 700mA
Total consumption: 45W
Material: Aluminium / Acrylic

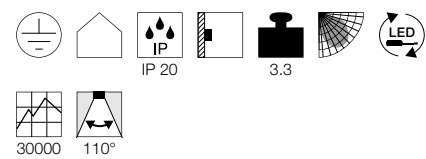

Dimensioned drawing

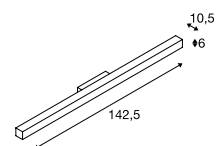

Variant	Item no.
3800lm 3000K CRI>80 white	1000668
3800lm 3000K CRI>80 black	1000669
3800lm 3000K CRI>80 grey	1000670

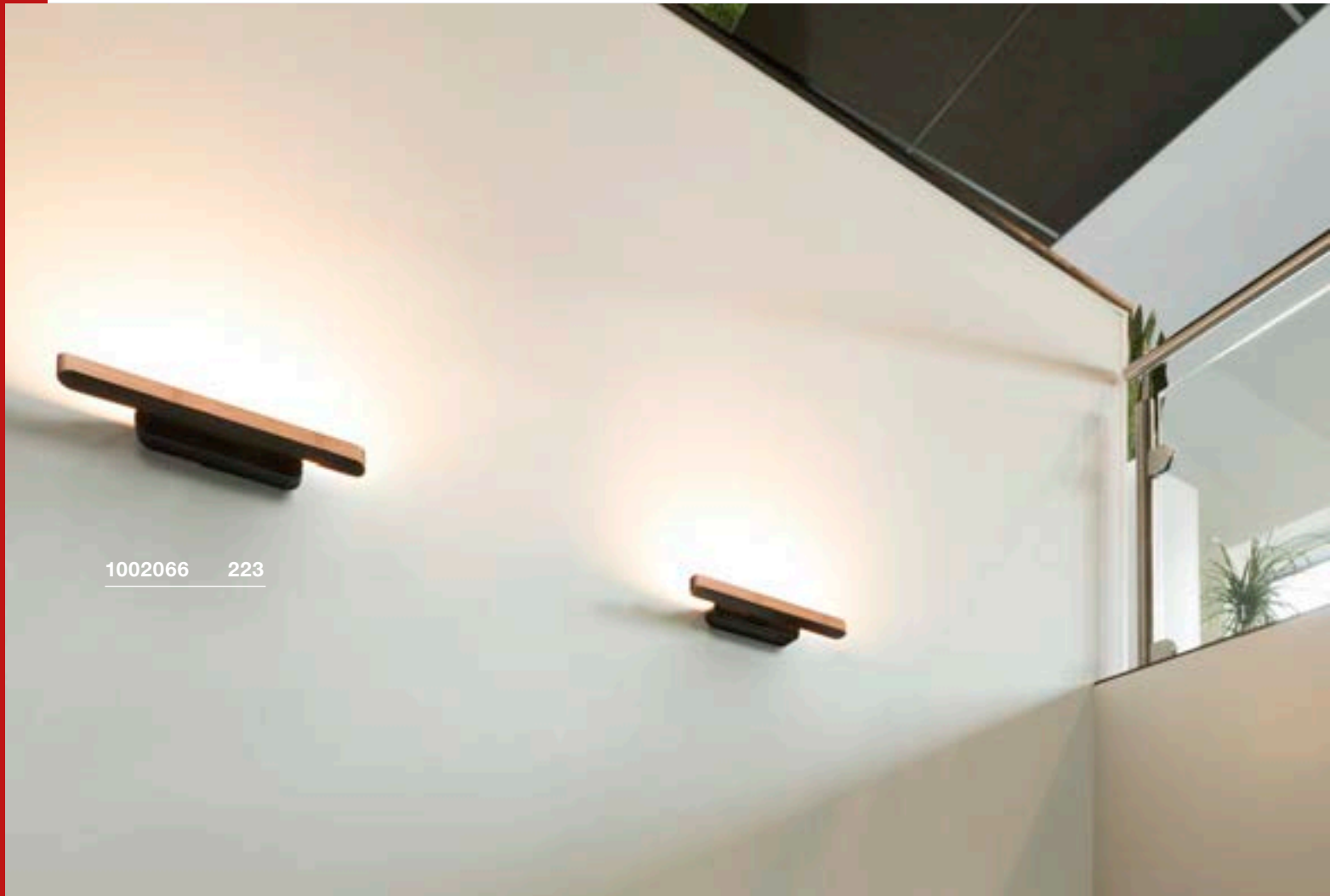

1002066 223



1002067 223



1002960 223

VINCELLI D
WL



A-A++ Range A++-E



- Slim design
- Lamp unit made from real bamboo

Product details

220-240V ~50/60Hz | 350mA
Total consumption: 11W
Material: Bamboo / Steel
Dimmable: Triac C, Triac L

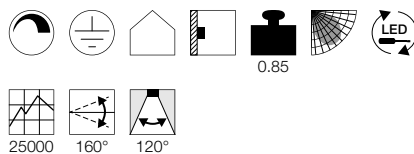

25000 160° 120°

Dimensioned drawing

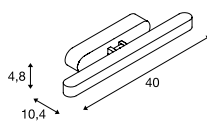

VINCELLI D
WL



A-A++ Range A++-E



- Slim design
- Lamp unit made from real bamboo

Product details

220-240V ~50/60Hz | 350mA
Total consumption: 11W
Material: Bamboo / Steel
Dimmable: Triac C, Triac L

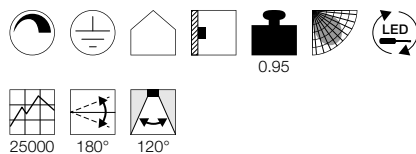

25000 180° 120°

Dimensioned drawing

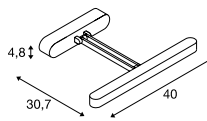

RETRATO
WL

A-A++ Range A++-E



- Rotating and swivelling lamp head

Product details

220-240V ~50/60Hz
Total consumption: 12W
Material: Aluminium / Steel
Dimmable: Triac C, Triac L

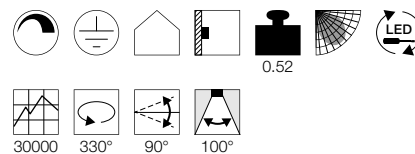

30000 330° 90° 100°

Dimensioned drawing

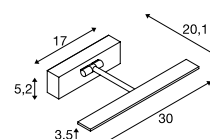

Variant	Item no.
500lm 2700K CRI>80 ■ anthracite / brown	1002066

Variant	Item no.
500lm 2700K CRI>80 ■ anthracite / brown	1002067

Variant	Item no.
730lm 3000K CRI>90 ■ matt white / chrome	1002960
730lm 3000K CRI>90 ■ matt chrome	1002961

FILI, CANOPY
WL, QPAR51



• Rotating and swivelling lamp head

Product details

220-240V ~50/60Hz
Material: Aluminium / Brass

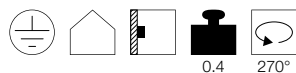

Dimensioned drawing

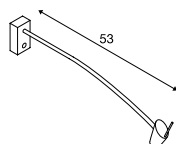

Note

Deco ring 51 mm incl.

Recommended lamp

LED GU10 7.2W 36°
3000K 520lm EEL=A+
8kWh/1000h
Item no. 1001561



LED GU10 7.2W 36°
4000K 540lm EEL=A+
8kWh/1000h
Item no. 1001564



Lamp details

max. 50W QPAR51

Variant	Item no.
GU10 QPAR51	
■ grey	146482

FILI, TERMINAL
WL, QPAR51

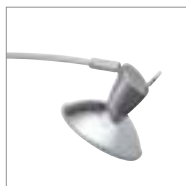

• Rotating and swivelling lamp head

Product details

230V ~50Hz
Material: Aluminium / Brass



Dimensioned drawing

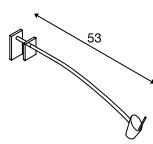

Note

Clamping range max. 8 cm

Recommended lamp

LED GU10 5.5W 38°
2700K 400lm EEL=A+
6kWh/1000h
Item no. 1001030



LED GU10 7.2W 36°
2700K 470lm EEL=A+
8kWh/1000h
Item no. 560542



Lamp details

max. 50W QPAR51

Variant	Item no.
GU10 QPAR51	
■ grey	146452

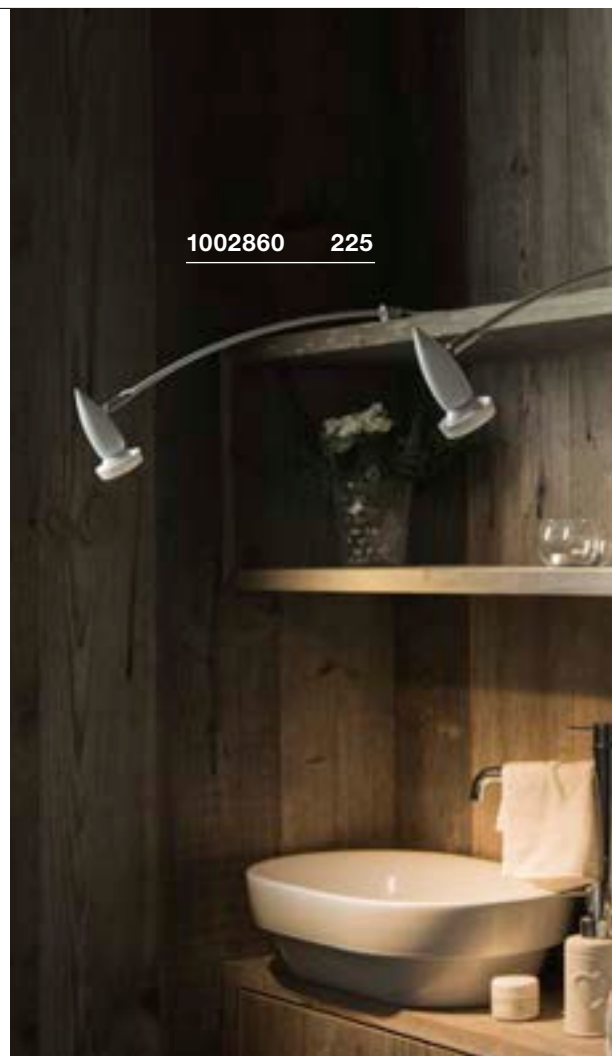

1002860 225



146452 224



DISPLAY ADL 50
QPAR51

E-A++ Range A++-E

NEW COLOR



- Rotating and swivelling lamp head

Product details

220-240V ~50/60Hz
Material: Aluminium / Brass



Dimensioned drawing

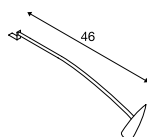

Recommended accessories

- Lamp deco ring diam. 5.7cm
Item no. 151041
- Lamp deco ring diam. 5.7cm
Item no. 151049

Recommended lamp

- LED GU10 7.2W 36°
3000K 520lm EEL=A+
8kWh/1000h
Item no. 1001563
- LED GU10 7.2W 36°
4000K 540lm EEL=A+
8kWh/1000h
Item no. 1001566

Lamp details

max. 50W QPAR51

Variant	Item no.
GU10 QPAR51 <input type="checkbox"/> white	1002860
GU10 QPAR51 <input type="checkbox"/> chrome	146332

SPOT DISPLAY
E27



A-A++ Range A++-E

NEW



- Switch at connection lead

Product details

220-240V ~50/60Hz
Material: Aluminium / Steel



Dimensioned drawing

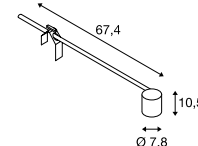

Note

Shock-proof mains plug
Clamping range: 10-60 mm

Lamp details

max. 18.5W

Variant	Item no.
E27 <input checked="" type="checkbox"/> matt black	1002985
E27 <input type="checkbox"/> matt white	1002986
E27 <input checked="" type="checkbox"/> matt grey	1002987

1000734 227



1000746 + 1000748 139



1000734 227



1001464 227

ANELA
Display



A-A++ Range A++-E



LENITO
WL



A-A++ Range A++-E



- Switch at connection lead

- Easy installation due to screw terminal with wing nut

Product details

220-240V ~50/60Hz
Total consumption: 10W
Material: Aluminium
Dimmable: Triac C, Triac L

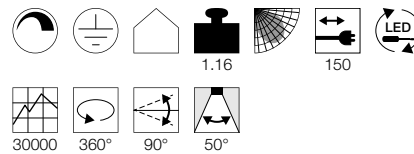

Dimensioned drawing

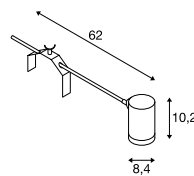

Note

2-pin plug
Clamping range: 7-50 mm

Product details

220-240V ~50/60Hz | 160mA
Total consumption: 23W
Material: Aluminium / Polycarbonate (PC)

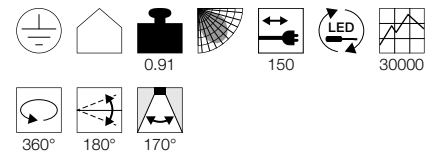

Dimensioned drawing

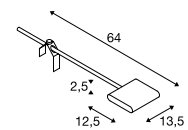

Note

Shock-proof 2-pin plug and switch
Clamping range: 10-45 mm

Recommended accessories

■ Nepro Display tube kit
Item no. 146479



Variant	Item no.
750lm 3000K CRI>80	
■ black	1000733
750lm 3000K CRI>80	
□ white	1000734
750lm 4000K CRI>80	
■ black	1001009
750lm 4000K CRI>80	
□ white	1001010

Variant	Item no.
2500lm 3000K CRI>80	
□ white	1001464
2350lm 3000K CRI>80	
■ black	1001465

MALO DISPLAY WL

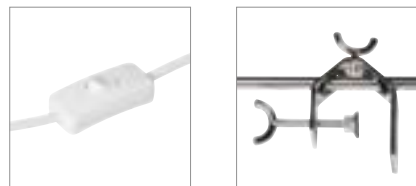

- Easy installation due to screw terminal with wing nut

Product details

230V ~50Hz
Total consumption: 23W
Material: Aluminium

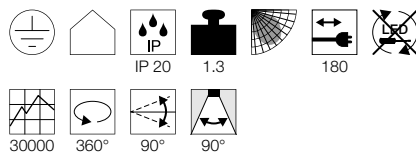

Dimensioned drawing

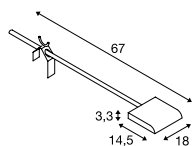

Note

2-pin plug and switch
Clamping range: 15-55 mm

NEPRO DISPLAY QT-DE12



- Rotating and swivelling head
- Easy installation due to screw terminal with wing nut

Product details

230V ~50Hz
Material: Aluminium

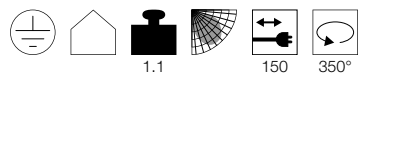

Dimensioned drawing

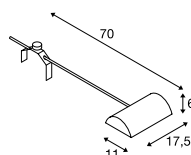

Note

Shock-proof 2-pin plug and switch
Clamping range: 15-55 mm

Recommended accessories

■ Nepro Display tube kit
Item no. 146479

Recommended lamp

R7s 118mm 6.5W
3000K 806lm EEL=A++
7kWh/1000h
Item no. 551893

LED R7s 118mm 14W
3000K 2000lm EEL=A++
14kWh/1000h
Item no. 1002135

Lamp details

max. 300W QT-DE12

Variant	Item no.
1600lm 4000K CRI>80 ■ grey	1001857
1600lm 4000K CRI>80 ■ white / chrome	1001858

Variant	Item no.
R7s 118mm QT-DE12 ■ grey / chrome	146472





170401 229

DISPLAY

A-A++ Range A++-E



- Rotating and swivelling lamp head
- Easy installation using screw clamp

Product details

230V ~50Hz | 24V DC
 Total consumption: 16W
 Material: Aluminium / Plastic

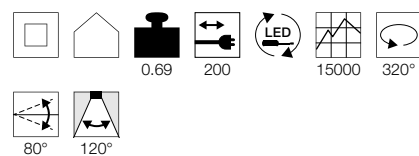

Dimensioned drawing

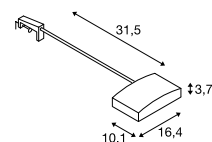

Note

Clamping range: 5-55 mm
 2-pin plug



1001857 228

Variant	Item no.
1100lm 4000K CRI>80	
■ grey	170401
1060lm 3000K CRI>80	
■ grey	170402

THE BEST THINGS COME FROM ABOVE.

CEILING LIGHTS FOR FLEXIBLE LIGHTING.

Ceiling lights are the centrepiece of any room. They bring a warm ambience into each space with their radiant power. Adapted to the room concept, you can align the luminaires in an optimum way and set impressive emphasis of light from above.

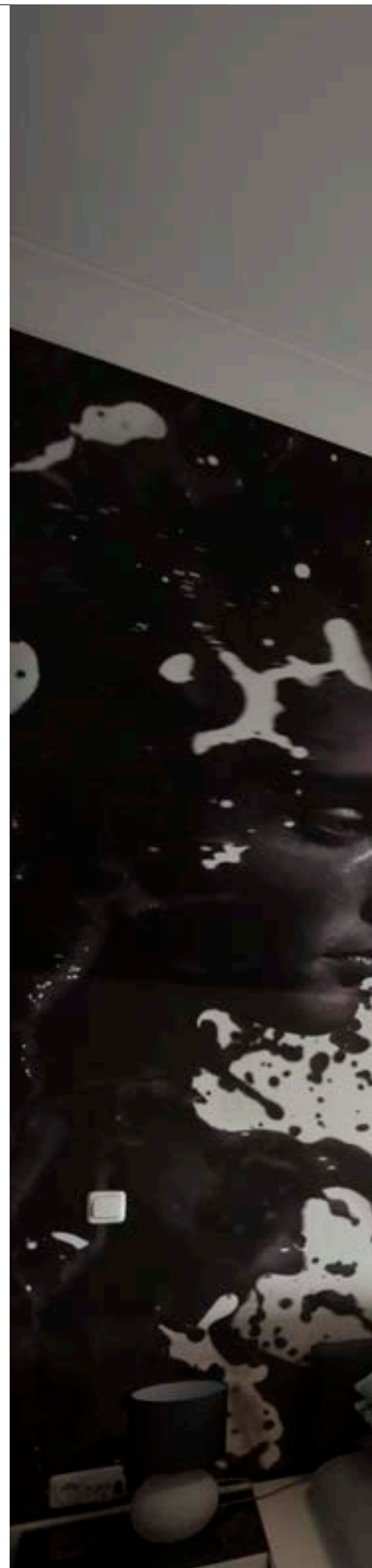



156050 237

1002968 241



CEILING LIGHTS

 234	 235	 235	 235	 236	 237	 237	 238
 238	 240	 240	 240	 241	 241	 246	 247
 248	 248	 248	 249	 250	 251	 251	 251
 252	 252	 252	 253	 254	 255	 256	 257
 257	 257	 258	 258	 259	 259	 260	 260
 260	 262	 263	 263	 263	 264	 264	 265
 265	 266	 266	 266	 267	 267	 268	 268
 269	 269	 270	 271	 271	 271	 272	 272
 273	 273	 274	 274	 275	 275	 276	 276
 277	 277	 277					

SLV FENDA. MIX & MATCH.

MIX & MATCH

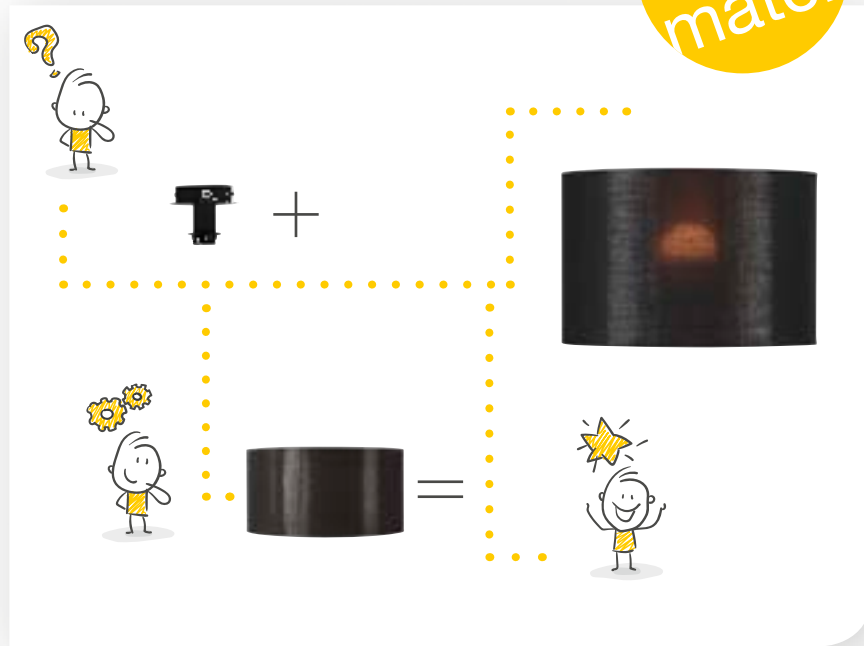

FENDA
Ceiling plate, E27



E-A++ Range A++-E



- Individually configurable by selecting the lamp shades

Product details

230V ~50Hz
Material: Steel

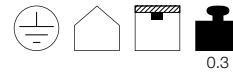

Dimensioned drawing

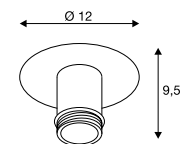

Recommended lamp

LED E27 14.5W 200°
2700K 1521lm EEL=A+
15kWh/1000h
Item no. 560422



LED E27 7W 330°
2700K 806lm EEL=A+
8kWh/1000h
Item no. 1001038



Lamp details

max. 60W

Variant	Item no.
E27	
■ black	155550
E27	
□ white	155551
E27	
■ chrome	155552



155552 + 156122 234 + 235

FENDA
Ø 30 cm, round



- Individually configurable by selecting a suitable lamp base

Product details

Material: Textile / Steel



Dimensioned drawing

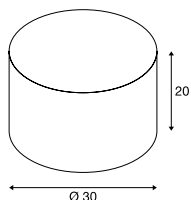

Note

max. 60W
Acrylic glass cover (155570) available as an accessory for closing the shade at one side



Recommended accessories

Acrylic glass cover
Item no. 155570

Variant	Item no.
<input type="checkbox"/> white	155582
<input type="checkbox"/> beige	155583
<input type="checkbox"/> black / copper	155592

FENDA
Ø 45 cm, round



- Individually configurable by selecting a suitable lamp base

Product details

Material: Textile / Steel



Dimensioned drawing

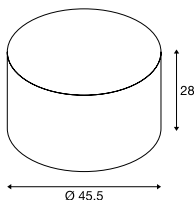

Note

max. 60W
Acrylic glass cover (156100) available as an accessory for closing the shade at one side



Recommended accessories

Acrylic glass cover
Item no. 156100

Variant	Item no.
<input type="checkbox"/> white	156111
<input type="checkbox"/> beige	156113
<input type="checkbox"/> black / copper	156122

FENDA
Ø 70 cm, round

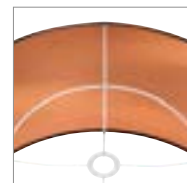

- Individually configurable by selecting a suitable lamp base

Product details

Material: Textile / Steel



Dimensioned drawing

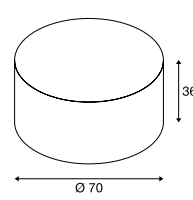

Note

max. 60W
Acrylic glass cover (1000957) available as an accessory for closing the shade at one side



Recommended accessories

Acrylic glass cover
Item no. 1000957

Variant	Item no.
<input type="checkbox"/> white	1000579
<input checked="" type="checkbox"/> black / copper	1000580

ACCANTO
CL, E27

882

E-A++ Range
A++-E

NEW



- Acrylic cover on underside of shade

Product details

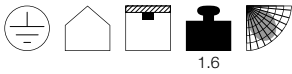
220-240V ~50/60Hz
Material: Steel / Textile

1.6

Dimensioned drawing

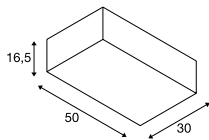

Lamp details

2x max. 40W

Variant	Item no.
E27	
■ white / black	1002944
E27	
□ white / white	1002945

1002945 236

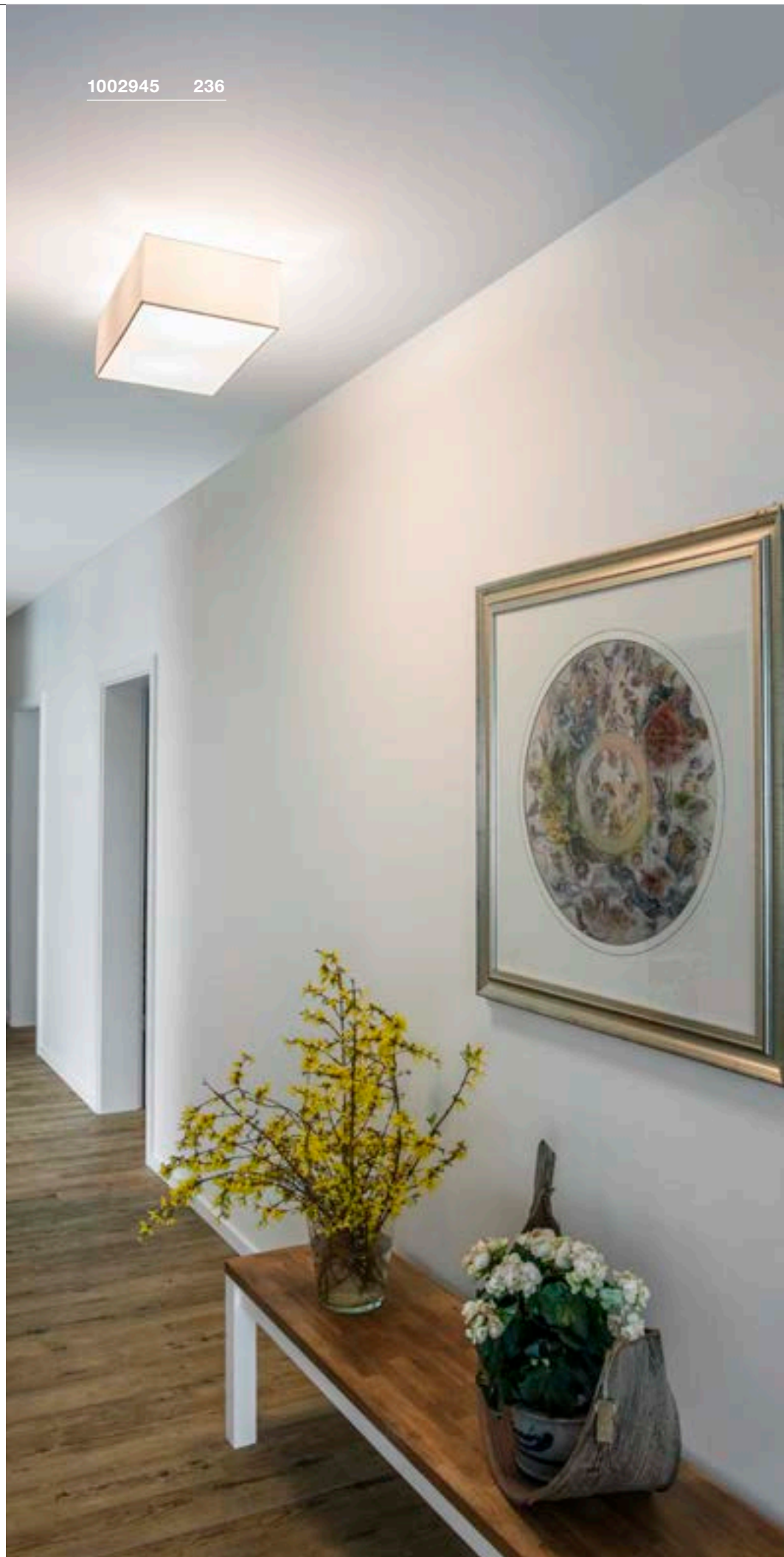



156050 237

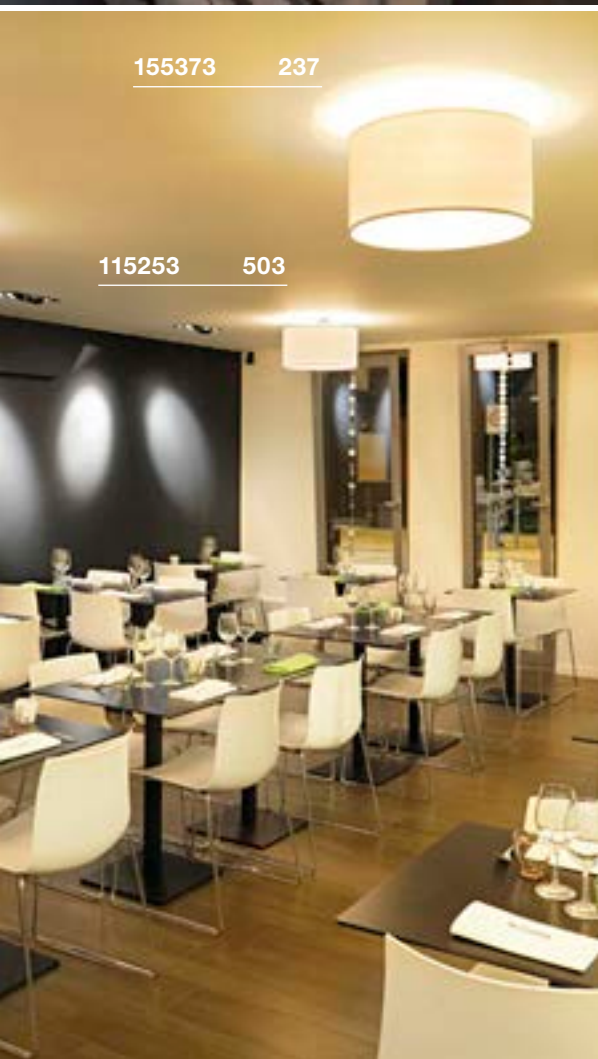

155373 237

115253 503

TENORA
CL, E27



A-A++ Range A++-E

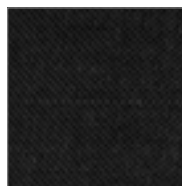

Product details

230V ~50Hz
Material: Steel / Textile

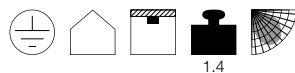

1.4

Dimensioned drawing

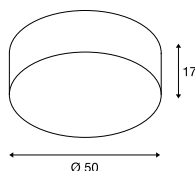

Note

Canopy: Ø 12 cm

Recommended lamp

LED E27 9,1W 240°
2700K 760lm EEK=A+
10kWh/1000h
Item no. 560402



LED E27 7W 280°
2200-2700K 830lm EEI=A++
7kWh/1000h
Item no. 1002126



Lamp details

3x max. 23W
L: 14.8 cm max.

Variant	Item no.
E27	
■ black	156050
E27	
□ white	156051

SOPRANA
CL, E27



E-A++ Range A++-E



Product details

230V ~50Hz
Material: Steel / Textile

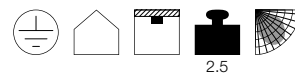

2.5

Dimensioned drawing

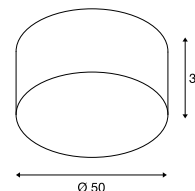

Note

Canopy: Ø 15 cm

Recommended lamp

LED E27 7W 280°
2700K 790lm EEI=A++
7kWh/1000h
Item no. 1002124



LED E27 7W 280°
2200-2700K 830lm EEI=A++
7kWh/1000h
Item no. 1002126



Lamp details

3x max. 60W
L: 20 cm max.

Variant	Item no.
E27	
□ white	155372
E27	
■ beige	155373

BATO 45
CW, E27



E-A++ Range A++-E



BATO 45
CW



A-A++ Range A++-E



LED INSIDE



Product details

220-240V ~50/60Hz
Material: Aluminium / Steel

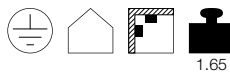

Product details

220-240V ~50/60Hz | 700mA
Total consumption: 30W
Material: Aluminium / Polymethylacrylate (PMMA)
Dimmable: Triac C

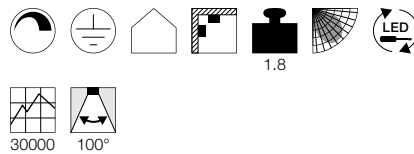

Dimensioned drawing

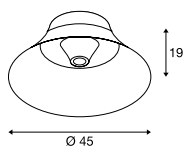

Dimensioned drawing

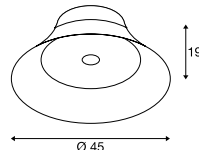

Recommended lamp

LED E27 7.1W 330°
2700K 806lm EEL=A+
8kWh/1000h
Item no. 1001756



LED E27 7W 280°
2200-2700K 830lm EEL=A++
7kWh/1000h
Item no. 1002126



Lamp details

max. 60W

Variant	Item no.
E27	
■ black	1000443
■ matt brass	1000445

Variant	Item no.
1450lm 2700K CRI>80	
■ black	1000437
1900lm 2500K CRI>80	
■ matt brass	1000442

1000442 238



1000445 238

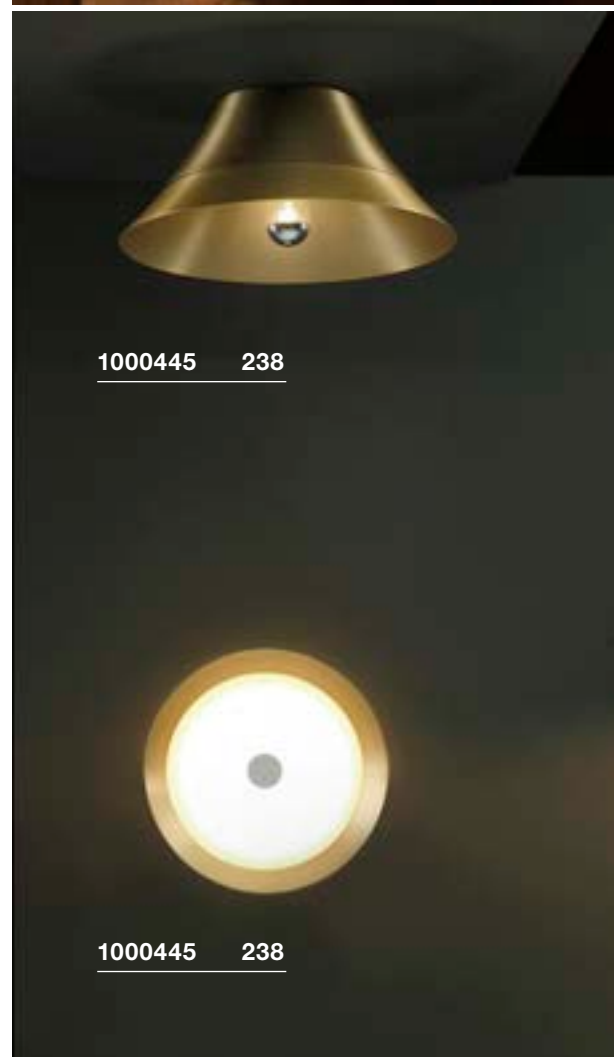

1000445 238

1000442 238



PLASTRA
CL



A-A++ Range A++-E



- Can be individually designed with colours, stickers and more

Product details

220-240V ~50/60Hz | 350mA
Total consumption: 15W
Material: Plaster / Steel
Dimmable: Triac C, Triac L

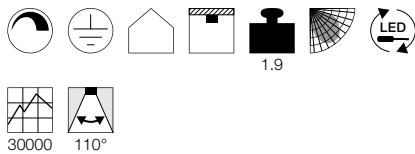

Dimensioned drawing

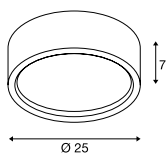

PLASTRA 105
CL, E27



E-A++ Range A++-E



- Can be individually designed with colours, stickers and more

Product details

220-240V ~50/60Hz
Material: Plaster / Glass

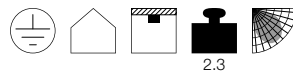

Dimensioned drawing

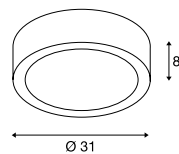

Recommended lamp

E27 9W 240°
3000K 810lm EEL=A+
10kWh/1000h
Item no. 1001031



LED E27 12W 240°
3000K 1055lm EEL=A+
12kWh/1000h
Item no. 1001032



Lamp details

2x max. 25W
Ø: 5 cm max. L: 14 cm max.

Variant	Item no.
990lm 3000K CRI>80	
□ white	148005

Variant	Item no.
E27	
□ white / matt transparent	148001

PLASTRA 104
CL, E27



E-A++ Range A++-E

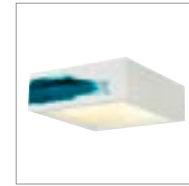

- Can be individually designed with colours, stickers and more

Product details

220-240V ~50/60Hz
Material: Plaster / Glass

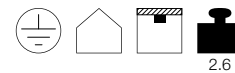

Dimensioned drawing

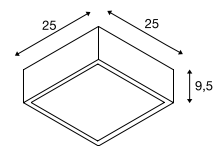

Recommended lamp

E27 11W
3000K 600lm EEL=A
11kWh/1000h
Item no. 508211



LED E27 12W 240°
3000K 1055lm EEL=A+
12kWh/1000h
Item no. 1001032



Lamp details

2x max. 25W
Ø: 5 cm max. L: 14 cm max.

Variant	Item no.
E27	
□ white / matt transparent	148002



1002968 241

**FERA 25
CL, DALI**

A-A++ Range A++-E



- Switchable light colour

Product details

220-240V ~50/60Hz | 500mA
 Total consumption: 19.5W
 Material:
 Polycarbonate (PC) / Polymethylacrylate (PMMA)
 Dimmable: Dali

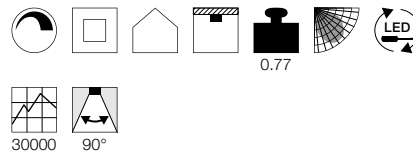

Dimensioned drawing

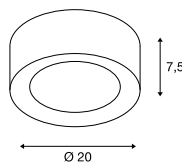

**FERA 25
CL**

A-A++ Range A++-E



Product details

100-240V ~50/60Hz | 550mA
 Total consumption: 21W
 Material:
 Aluminium / Polystyrene (PS)

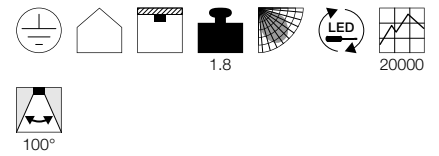

Dimensioned drawing

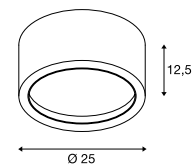

161461 241







Variant	Item no.
1580/1650lm 3000/4000K CRI>80	
□ matt white / frosted	1002967
1580/1650lm 3000/4000K CRI>80	
■ matt black / frosted	1002968





Variant	Item no.
2000lm 3000K CRI>80	
□ white	161461
2000lm 3000K CRI>80	
■ grey	161464
2000lm 3000K CRI>80	
■ black	1001939

MEDO LIGHT SERIES.

CEILING LIGHT OR PENDANT.

	MEDO 30 CL, 1-10V	MEDO 40 CL, 1-10V	MEDO 60 CL, 1-10V	MEDO 90 CL, 1-10V
Example				
Lamp				
Size	Ø: 30 cm	Ø: 40 cm	Ø: 60 cm	Ø: 90 cm
Luminous intensity	1000lm	2000lm	3500lm	11000lm
UGR	25	25	22	25
Dimmable	1-10V	1-10V	1-10V	1-10V
Suspension set	1.5 m 5 m	1.5 m 5 m	1.5 m 5 m	1.5 m 5 m

	MEDO 30 CL, TRIAC	MEDO 40 CL, TRIAC	
Example			
Lamp			
Size Ø	Ø: 30 cm	Ø: 40 cm	
Luminous intensity	1200lm	2125lm	
UGR	25	25	
Dimmable	Triac C, Triac L	Triac C, Triac L	
Suspension set (excl.)	1.5 m 5 m	1.5 m 5 m	
			 <p>This MEDO variant is dimmed using TRIAC dimmers!</p>

	MEDO 60 CL, square, 1-10V	MEDO 60 CL, square, DALI
Example		
Lamp		
Size	W L: 60 cm	W L: 60 cm
Luminous intensity	3300 lm	3300 lm
UGR	22	22
Dimmable	1-10V	Dali
Suspension set	1.5 m 5 m	1.5 m 5 m



MEDO LIGHT SERIES.

CEILING LIGHT OR PENDANT.

	MEDO 30 CORONA CW, TRIAC	MEDO 40 CORONA CW, TRIAC	MEDO 60 CORONA CW, TRIAC	MEDO 90 CORONA CL, TRIAC
Example				
Lamp				
Size	Ø: 30 cm	Ø: 40 cm	Ø: 60 cm	Ø: 90 cm
Luminous intensity	Down: 1230/1280lm Up: 20lm	Down: 2750/2900lm Up: 50lm	Down: 4350/4750lm Up: 120lm	Down: 9500/10100lm Up: 125lm
UGR	25	25	25	25
Dimmable	Triac C	Triac C	Triac C	Triac C
Suspension set	1.5 m 5 m	1.5 m 5 m	1.5 m 5 m	1.5 m 5 m

	MEDO 30 CORONA CW, DALI	MEDO 40 CORONA CW, DALI	MEDO 60 CORONA CW, DALI	MEDO 90 CORONA CL, DALI
Example				
Lamp				
Size	Ø: 30 cm	Ø: 40 cm	Ø: 60 cm	Ø: 90 cm
Luminous intensity	Down: 1230/1280lm Up: 20lm	Down: 2750/2900lm Up: 50lm	Down: 4350/4750lm Up: 120lm	Down: 9500/10100lm Up: 125lm
UGR	25	25	25	25
Dimmable	DALI	DALI	DALI	DALI
Suspension set	1.5 m 5 m	1.5 m 5 m	1.5 m 5 m	1.5 m 5 m



Corona effect these MEDO variants have homogeneous indirect upwards-directed light emission.

Colour temperature – with this MEDO variant you can select the colour temperature yourself. You can choose between 3000K and 4000K using the switch on the back.

MEDO 30
CL, TRIAC



A-A++ Range
A++-E



135070 247

135250 246



135120 248

135020 246

Product details

220-240V ~50/60Hz | 350mA
Total consumption: 16W
Material: Aluminium / Polymethylacrylate (PMMA)
Dimmable: Triac C, Triac L

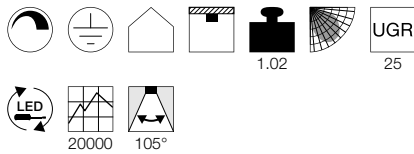

Dimensioned drawing

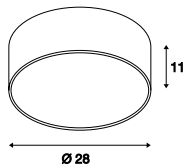

Note

Suspension set excl.

Recommended accessories

- Suspension set 1.5m
Item no. 135250
- Suspension set 1.5m
Item no. 135251
- Suspension set 1.5m
Item no. 135254
- Suspension set 5m
Item no. 1001950
- Suspension set 5m
Item no. 1001951
- Suspension set 5m
Item no. 1001952

Variant	Item no.
1200lm 3000K CRI>80 ■ black	135020
1200lm 3000K CRI>80 □ white	135021
1200lm 3000K CRI>80 ■ grey	135024
1200lm 3000K CRI>80 ■ red	135026

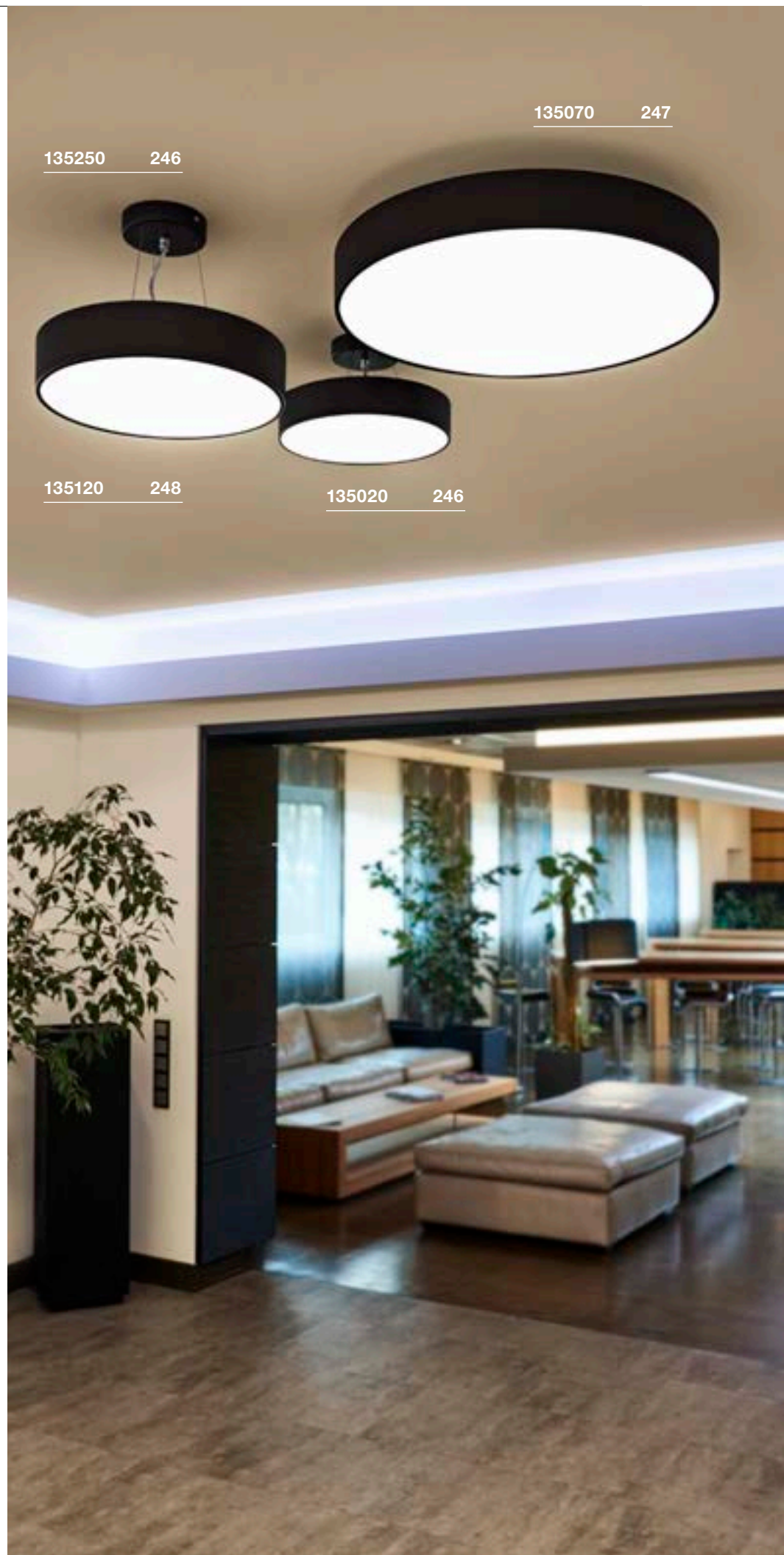



135071 247

MEDO 40
CL, TRIACA-A++ Range
A++-ELED
INSIDE

Product details

220-240V ~50/60Hz | 700mA

Total consumption: 31W

Material: Aluminium / Polymethylacrylate (PMMA)

Dimmable: Triac C, Triac L

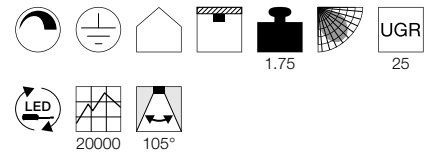

Dimensioned drawing

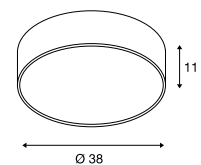

Note

Suspension set excl.

Recommended accessories

■ Suspension set 1.5m

Item no. 135250

□ Suspension set 1.5m

Item no. 135251

■ Suspension set 1.5m

Item no. 135254

□ Suspension set 5m

Item no. 1001950

■ Suspension set 5m

Item no. 1001951

■ Suspension set 5m

Item no. 1001952

Variant	Item no.
2125lm 3000K CRI>80	
■ black	135070
2125lm 3000K CRI>80	
□ white	135071
2125lm 3000K CRI>80	
■ grey	135074
2125lm 3000K CRI>80	
■ red	135076

MEDO 30
CL, 1-10V



A-A++ Range A++-E



Product details

220-240V ~50/60Hz | 350mA
Total consumption: 15W
Material: Aluminium / Polymethylacrylate (PMMA)
Dimmable: 1-10V

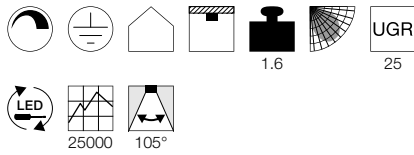

Dimensioned drawing

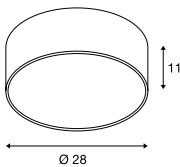

Note

Suspension set excl.

Recommended accessories

- Suspension set 1.5m
Item no. 135250
- Suspension set 1.5m
Item no. 135251
- Suspension set 1.5m
Item no. 135254
- Suspension set 5m
Item no. 1001950
- Suspension set 5m
Item no. 1001951
- Suspension set 5m
Item no. 1001952

Variant	Item no.
1000lm 3000K CRI>80 ■ black	1000855
1000lm 3000K CRI>80 □ white	1000856
1000lm 3000K CRI>80 ■ grey	1000857

MEDO 40
CL, 1-10V



A-A++ Range A++-E



Product details

120-240V ~50/60Hz | 700mA
Total consumption: 29W
Material: Aluminium / Polymethylacrylate (PMMA)
Dimmable: 1-10V

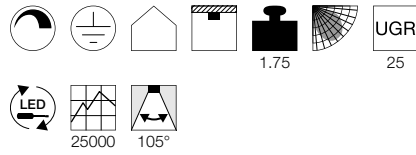

Dimensioned drawing

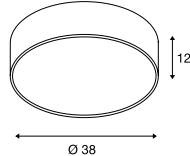

Note

Suspension set excl.

Recommended accessories

- Suspension set 1.5m
Item no. 135250
- Suspension set 1.5m
Item no. 135251
- Suspension set 1.5m
Item no. 135254
- Suspension set 5m
Item no. 1001950
- Suspension set 5m
Item no. 1001951
- Suspension set 5m
Item no. 1001952

Variant	Item no.
2000lm 3000K CRI>80 ■ black	1000864
2000lm 3000K CRI>80 □ white	1000865
2000lm 3000K CRI>80 ■ grey	1000866

MEDO 60
CL, 1-10V



A-A++ Range A++-E



Product details

100-240V ~50/60Hz | 1000mA
Total consumption: 40W
Material: Aluminium / Polymethylacrylate (PMMA)
Dimmable: 1-10V

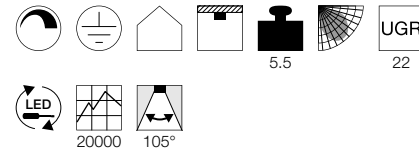

Dimensioned drawing

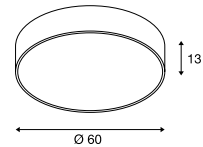

Note

Suspension set excl.

Recommended accessories

- Suspension set 1.5m
Item no. 135250
- Suspension set 1.5m
Item no. 135251
- Suspension set 1.5m
Item no. 135254
- 1-10V dimming
Item no. 470505
- Suspension set 5m
Item no. 1001950
- Suspension set 5m
Item no. 1001951
- Suspension set 5m
Item no. 1001952

Variant	Item no.
3500lm 3000K CRI>80 ■ black	135120
3500lm 3000K CRI>80 □ white	135121
3500lm 3000K CRI>80 ■ grey	135124
3500lm 3000K CRI>80 ■ red	135126



135121 248



135021 246

135171 249

135121 248



MEDO 90
CL, 1-10V



A-A++ Range A++-E



Product details

220-240V ~50/60Hz | 2900mA
Total consumption: 119W
Material: Aluminium / Polymethylacrylate (PMMA)
Dimmable: 1-10V

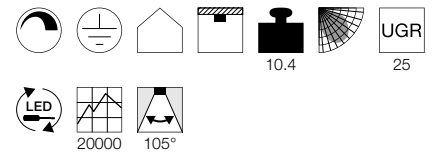

Dimensioned drawing

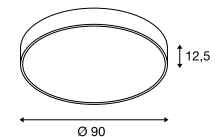

Note

Suspension set excl.

Recommended accessories

- Suspension set 1.5m
Item no. 135250
- Suspension set 1.5m
Item no. 135251
- Suspension set 1.5m
Item no. 135254
- 1-10V dimming
Item no. 470505
- Suspension set 5m
Item no. 1001950
- Suspension set 5m
Item no. 1001951
- Suspension set 5m
Item no. 1001952

Variant	Item no.
11000lm 3000K CRI>80	
■ black	135170
11000lm 3000K CRI>80	
□ white	135171
11000lm 3000K CRI>80	
■ grey	135174
11000lm 3000K CRI>80	
■ red	135176

MEDO 30 CORONA
CW, TRIAC



891

A-A++ Range
A++-E

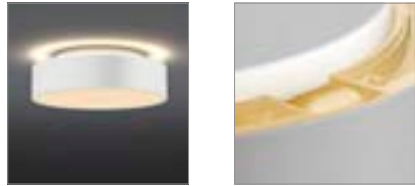

- With corona effect
- Colour temperature (3000K/4000K) selectable using a switch

Product details

220-240V ~50/60Hz | 350mA
 Total consumption: 15W
 Material: Aluminium / Polycarbonate (PC)
 Dimmable: Triac C

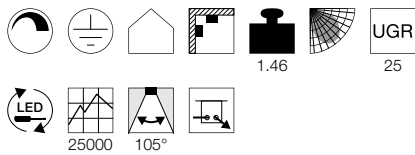

Dimensioned drawing

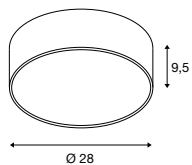

Note

Suspension set excl.

Recommended accessories

- Suspension set 1.5m
Item no. 135250
- Suspension set 1.5m
Item no. 135251
- Suspension set 1.5m
Item no. 135254
- Suspension set 5m
Item no. 1001950
- Suspension set 5m
Item no. 1001951
- Suspension set 5m
Item no. 1001952

Variant	Item no.
Down: 1230/1280lm 3000/4000K CRI>80 Up: 20lm 3000/4000K CRI>80	
■ black	1001877
Down: 1230/1280lm 3000/4000K CRI>80 Up: 20lm 3000/4000K CRI>80	
□ white	1001881
Down: 1230/1280lm 3000/4000K CRI>80 Up: 20lm 3000/4000K CRI>80	
■ grey	1001882

1001884 251

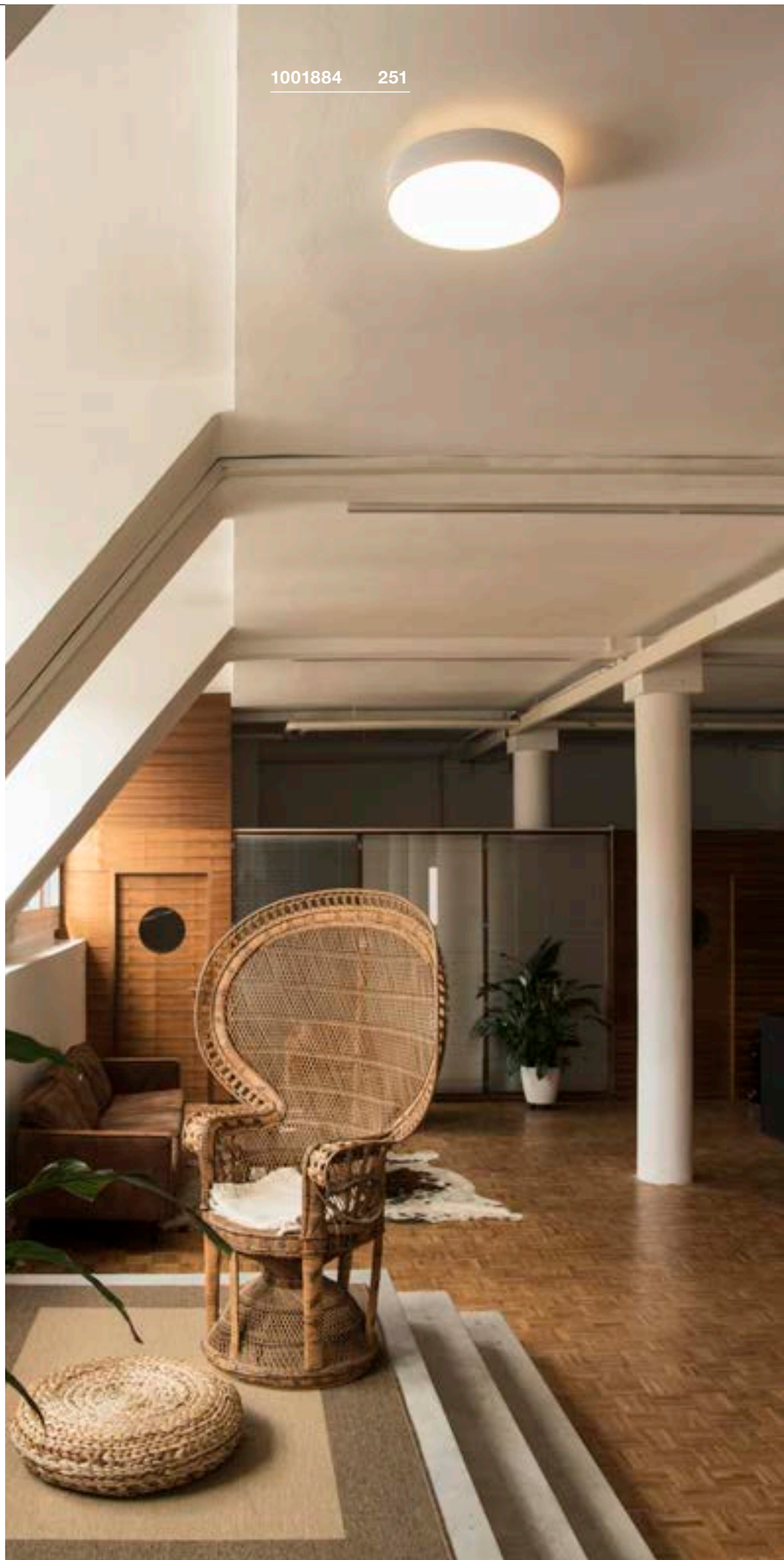

MEDO 40 CORONA
CW, TRIAC



A-A++ Range A++-E

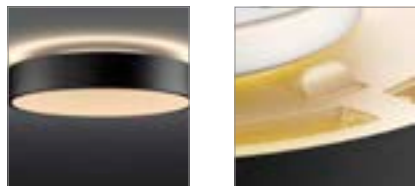

- With corona effect
- Colour temperature (3000K/4000K) selectable using a switch

Product details

220-240V ~50/60Hz | 700mA
Total consumption: 30W
Material: Aluminium / Polycarbonate (PC)
Dimmable: Triac C

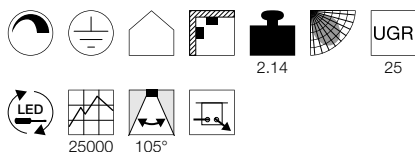

Dimensioned drawing

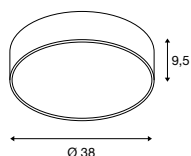

Note

Suspension set excl.

Recommended accessories

- Suspension set 1.5m
Item no. 135250
- Suspension set 1.5m
Item no. 135251
- Suspension set 1.5m
Item no. 135254
- Suspension set 5m
Item no. 1001950
- Suspension set 5m
Item no. 1001951
- Suspension set 5m
Item no. 1001952

Variant	Item no.
Down: 2750/2900lm 3000/4000K CRI>80 Up: 50lm 3000/4000K CRI>80	
■ black	1001883
Down: 2750/2900lm 3000/4000K CRI>80 Up: 50lm 3000/4000K CRI>80	
□ white	1001884
Down: 2750/2900lm 3000/4000K CRI>80 Up: 50lm 3000/4000K CRI>80	
■ grey	1001885

MEDO 60 CORONA
CW, TRIAC



A-A++ Range A++-E

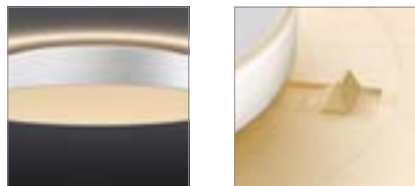

- With corona effect
- Colour temperature (3000K/4000K) selectable using a switch

Product details

220-240V ~50/60Hz | 1050mA
Total consumption: 40W
Material: Aluminium / Polycarbonate (PC)
Dimmable: Triac C

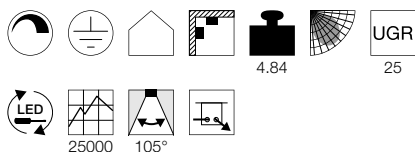

Dimensioned drawing

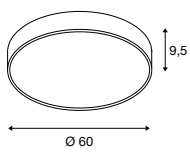

Note

Suspension set excl.

Recommended accessories

- Suspension set 1.5m
Item no. 135250
- Suspension set 1.5m
Item no. 135251
- Suspension set 1.5m
Item no. 135254
- Suspension set 5m
Item no. 1001950
- Suspension set 5m
Item no. 1001951
- Suspension set 5m
Item no. 1001952

Variant	Item no.
Down: 4350/4750lm 3000/4000K CRI>80 Up: 120lm 3000/4000K CRI>80	
■ black	1001886
Down: 4350/4750lm 3000/4000K CRI>80 Up: 120lm 3000/4000K CRI>80	
□ white	1001887
Down: 4350/4750lm 3000/4000K CRI>80 Up: 120lm 3000/4000K CRI>80	
■ grey	1001888

MEDO 90 CORONA
CL, TRIAC



A-A++ Range A++-E

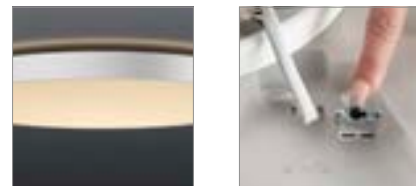

- With corona effect
- Colour temperature (3000K/4000K) selectable using a switch

Product details

220-240V ~50/60Hz | 1050mA
Total consumption: 78W
Material: Aluminium / Polycarbonate (PC)
Dimmable: Triac C

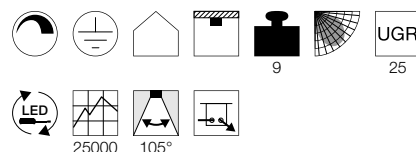

Dimensioned drawing

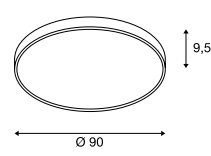

Note

Suspension set excl.

Recommended accessories

- Suspension set 1.5m
Item no. 135250
- Suspension set 1.5m
Item no. 135251
- Suspension set 1.5m
Item no. 135254
- Suspension set 5m
Item no. 1001950
- Suspension set 5m
Item no. 1001951
- Suspension set 5m
Item no. 1001952

Variant	Item no.
Down: 9500/10100lm 3000/4000K CRI>80 Up: 125lm 3000/4000K CRI>80	
■ black	1001878
Down: 9500/10100lm 3000/4000K CRI>80 Up: 125lm 3000/4000K CRI>80	
□ white	1001879
Down: 9500/10100lm 3000/4000K CRI>80 Up: 125lm 3000/4000K CRI>80	
■ grey	1001880

MEDO 30 CORONA
CW, DALI



A-A++ Range
A++-E

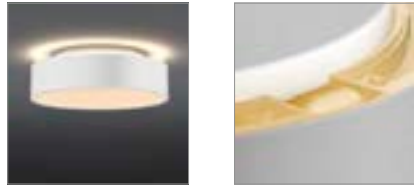

- With corona effect
- Colour temperature (3000K/4000K) selectable using a switch

Product details

220-240V ~50/60Hz | 350mA
Total consumption: 15W
Material: Aluminium / Polycarbonate (PC)
Dimmable: Dali

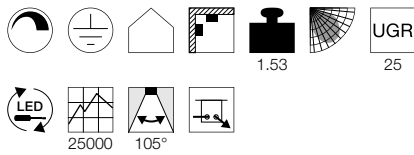

Dimensioned drawing

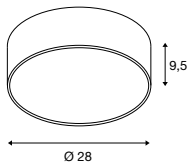

Note

Suspension set excl.

Recommended accessories

- Suspension set 1.5m
Item no. 135250
- Suspension set 1.5m
Item no. 135251
- Suspension set 1.5m
Item no. 135254
- Suspension set 5m
Item no. 1001950
- Suspension set 5m
Item no. 1001951
- Suspension set 5m
Item no. 1001952

Variant	Item no.
Down: 1230/1280lm 3000/4000K CRI>80 Up: 20lm 3000/4000K CRI>80	
■ black	1001889
Down: 1230/1280lm 3000/4000K CRI>80 Up: 20lm 3000/4000K CRI>80	
□ white	1001893
Down: 1230/1280lm 3000/4000K CRI>80 Up: 20lm 3000/4000K CRI>80	
■ grey	1001894

MEDO 40 CORONA
CW, DALI



A-A++ Range
A++-E

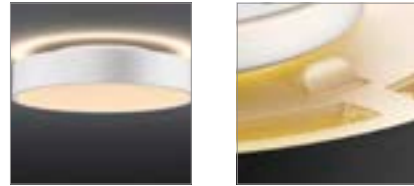

- With corona effect
- Colour temperature (3000K/4000K) selectable using a switch

Product details

220-240V ~50/60Hz | 700mA
Total consumption: 30W
Material: Aluminium / Polycarbonate (PC)
Dimmable: Dali

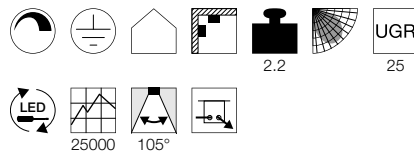

Dimensioned drawing

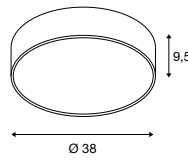

Note

Suspension set excl.

Recommended accessories

- Suspension set 1.5m
Item no. 135250
- Suspension set 1.5m
Item no. 135251
- Suspension set 1.5m
Item no. 135254
- Suspension set 5m
Item no. 1001950
- Suspension set 5m
Item no. 1001951
- Suspension set 5m
Item no. 1001952

Variant	Item no.
Down: 2750/2900lm 3000/4000K CRI>80 Up: 50lm 3000/4000K CRI>80	
■ black	1001895
Down: 2750/2900lm 3000/4000K CRI>80 Up: 50lm 3000/4000K CRI>80	
□ white	1001896
Down: 2750/2900lm 3000/4000K CRI>80 Up: 50lm 3000/4000K CRI>80	
■ grey	1001897

MEDO 60 CORONA
CW, DALI



A-A++ Range
A++-E

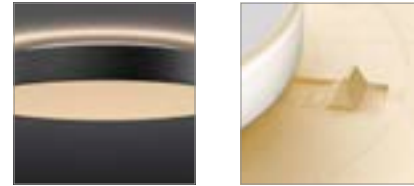

- With corona effect
- Colour temperature (3000K/4000K) selectable using a switch

Product details

220-240V ~50/60Hz | 1000mA
Total consumption: 40W
Material: Aluminium / Polycarbonate (PC)
Dimmable: Dali

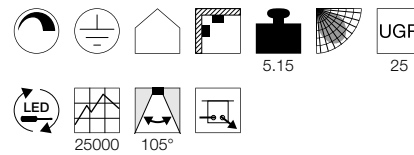

Dimensioned drawing

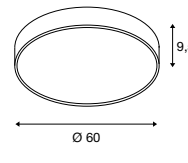

Note

Suspension set excl.

Recommended accessories

- Suspension set 1.5m
Item no. 135250
- Suspension set 1.5m
Item no. 135251
- Suspension set 1.5m
Item no. 135254
- Suspension set 5m
Item no. 1001950
- Suspension set 5m
Item no. 1001951
- Suspension set 5m
Item no. 1001952

Variant	Item no.
Down: 4350/4750lm 3000/4000K CRI>80 Up: 120lm 3000/4000K CRI>80	
■ black	1001898
Down: 4350/4750lm 3000/4000K CRI>80 Up: 120lm 3000/4000K CRI>80	
□ white	1001900
Down: 4350/4750lm 3000/4000K CRI>80 Up: 120lm 3000/4000K CRI>80	
■ grey	1001899

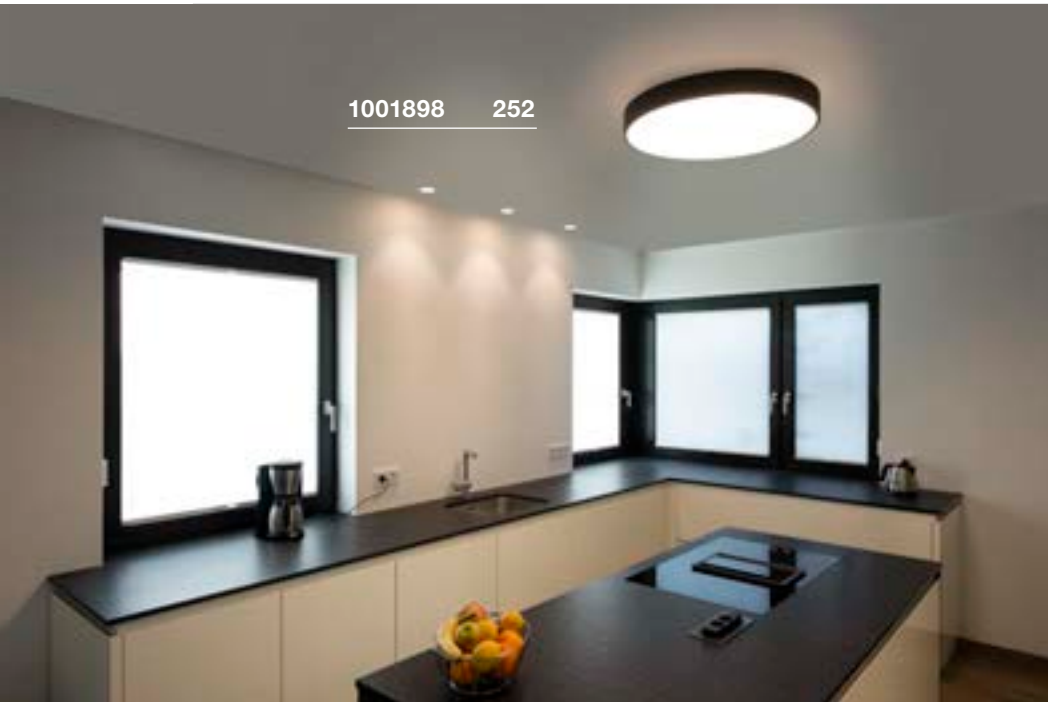

1001898 252

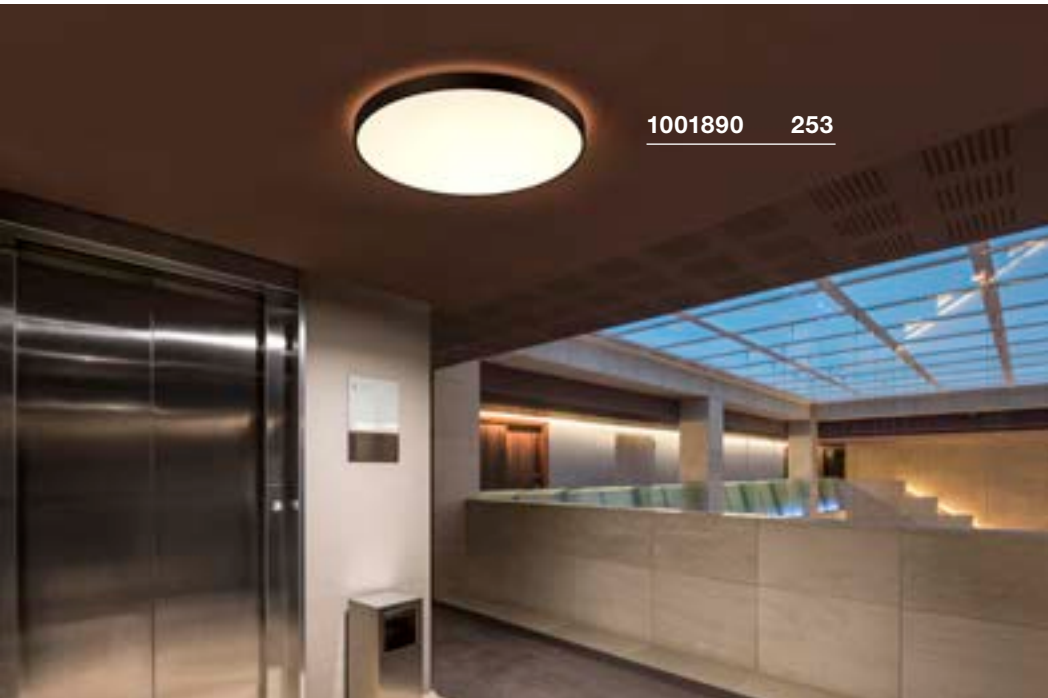

1001890 253



1001898 252

MEDO 90 CORONA CL, DALI



A-A++ Range A++-E



LED INSIDE

NEW VARIANT



- With corona effect
- Colour temperature (3000K/4000K) selectable using a switch

Product details

220-240V ~50/60Hz | 1000mA
 Total consumption: 78W
 Material: Aluminium / Polycarbonate (PC)
 Dimmable: Dali

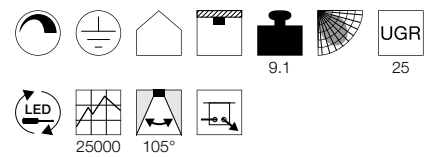

Dimensioned drawing

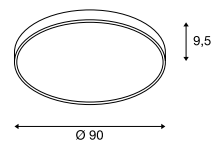

Note

Suspension set excl.

Recommended accessories

- Suspension set 1.5m
Item no. 135250
- Suspension set 1.5m
Item no. 135251
- Suspension set 1.5m
Item no. 135254
- Suspension set 5m
Item no. 1001950
- Suspension set 5m
Item no. 1001951
- Suspension set 5m
Item no. 1001952

Variant	Item no.
Down: 9500/10100lm 3000/4000K CRI>80 Up: 125lm 3000/4000K CRI>80	
■ black	1001890
Down: 9500/10100lm 3000/4000K CRI>80 Up: 125lm 3000/4000K CRI>80	
□ white	1001891
Down: 9500/10100lm 3000/4000K CRI>80 Up: 125lm 3000/4000K CRI>80	
■ grey	1001892

MEDO 60
CL, square



A-A++ Range
A++-E



1000725 254



Product details

100-240V ~50/60Hz | 1000mA
Total consumption: 39W
Material: Aluminium / Acrylic
Dimmable: 1-10V

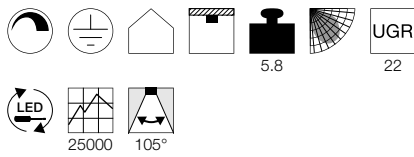

Dimensioned drawing

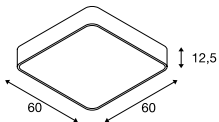

Note

Suspension set excl.

Recommended accessories

- Suspension set 1.5m
Item no. 135250
- Suspension set 1.5m
Item no. 135251
- Suspension set 1.5m
Item no. 135254
- 1-10V dimming
Item no. 470505
- Suspension set 5m
Item no. 1001950
- Suspension set 5m
Item no. 1001951
- Suspension set 5m
Item no. 1001952

Variant	Item no.
3300lm 3000K CRI>80	
<input checked="" type="checkbox"/> black	1000725
3300lm 3000K CRI>80	
<input type="checkbox"/> white	1000726
3300lm 3000K CRI>80	
<input checked="" type="checkbox"/> grey	1000727



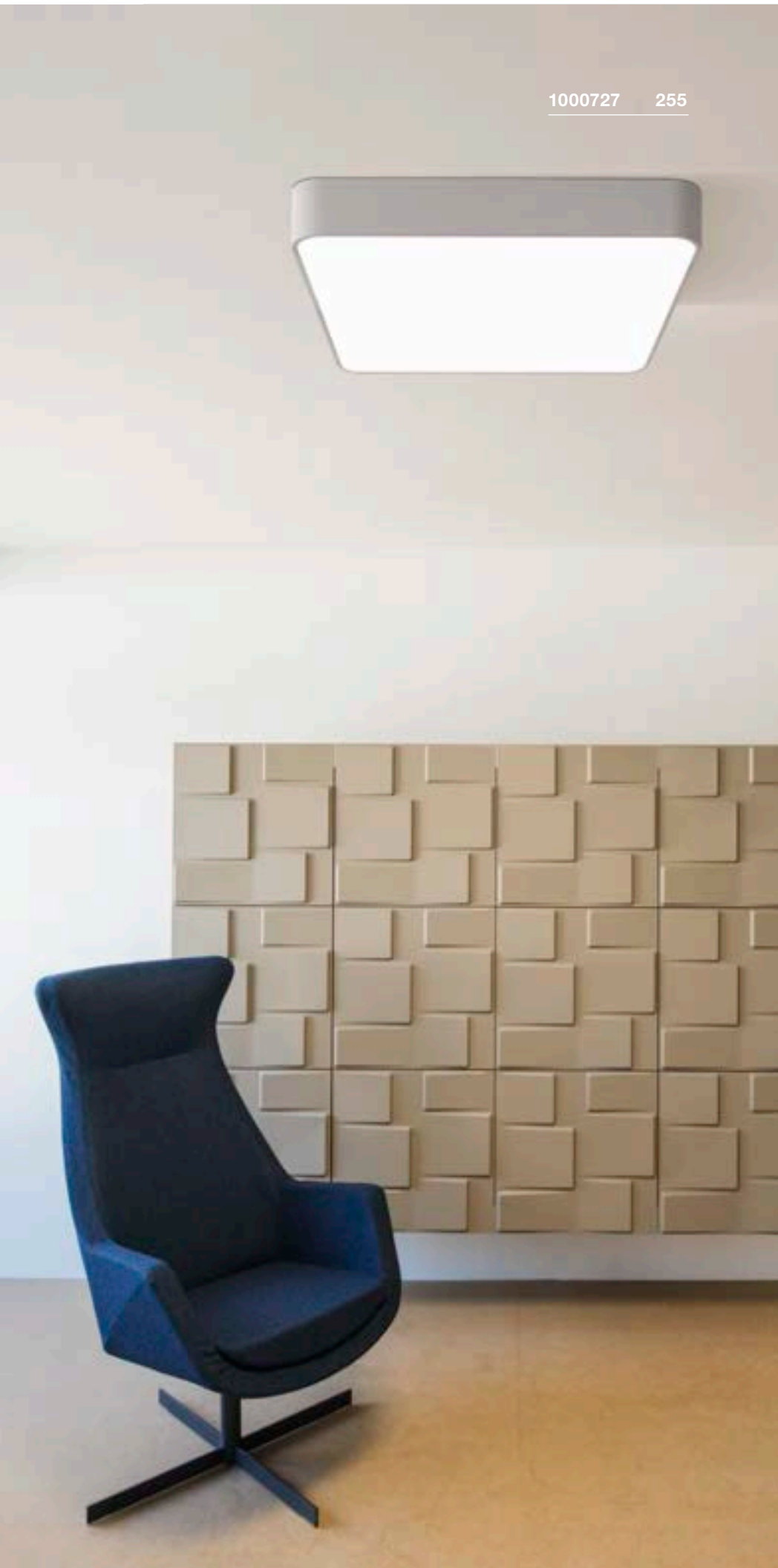

1000727 255

MEDO 60
CL, square, DALI



A-A++ Range A++-E

LED INSIDE

NEW VARIANT



Product details

100-277V ~50/60Hz | 1000mA
Total consumption: 39W
Material: Aluminium / Acrylic
Dimmable: Dali

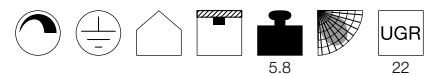

Dimensioned drawing

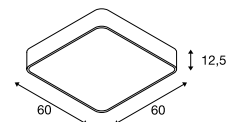

Recommended accessories

- Suspension set 1.5m
Item no. 135250
- Suspension set 1.5m
Item no. 135251
- Suspension set 1.5m
Item no. 135254
- Suspension set 5m
Item no. 1001950
- Suspension set 5m
Item no. 1001951
- Suspension set 5m
Item no. 1001952

Variant	Item no.
3300lm 3000K CRI>80 <input type="checkbox"/> white	1002882

PANEL 60
CL, round, TRIAC

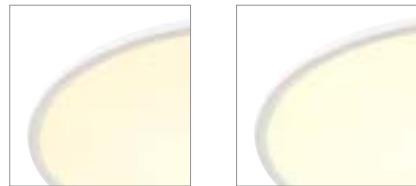

- Panel can be surface mounted or partially recessed

Product details

220-240V ~50/60Hz | 1000mA
 Total consumption: 42W
 Material: Aluminium / Polymethylacrylate (PMMA)
 Installation dimensions:
 Installation Ø: 20 cm D: 7 cm
 Dimmable: Triac C

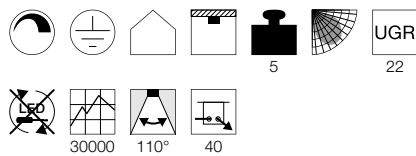

Dimensioned drawing

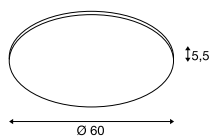

Variant	Item no.
3150lm 3000K CRI>80 □ white	1000783
3350lm 4000K CRI>80 □ white	1000784
3150lm 3000K CRI>80 ■ grey	1000785
3350lm 4000K CRI>80 ■ grey	1000786

1000783 256

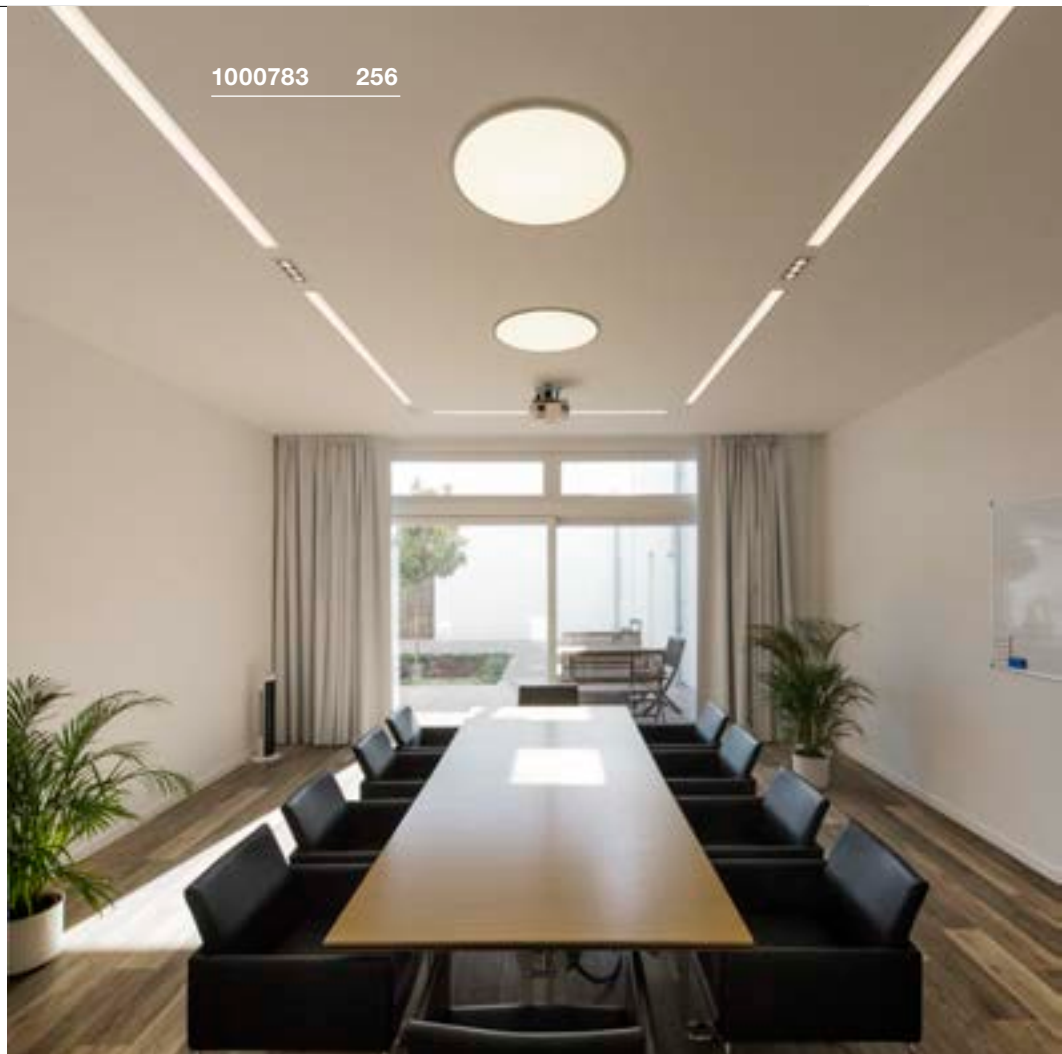

1000785 256

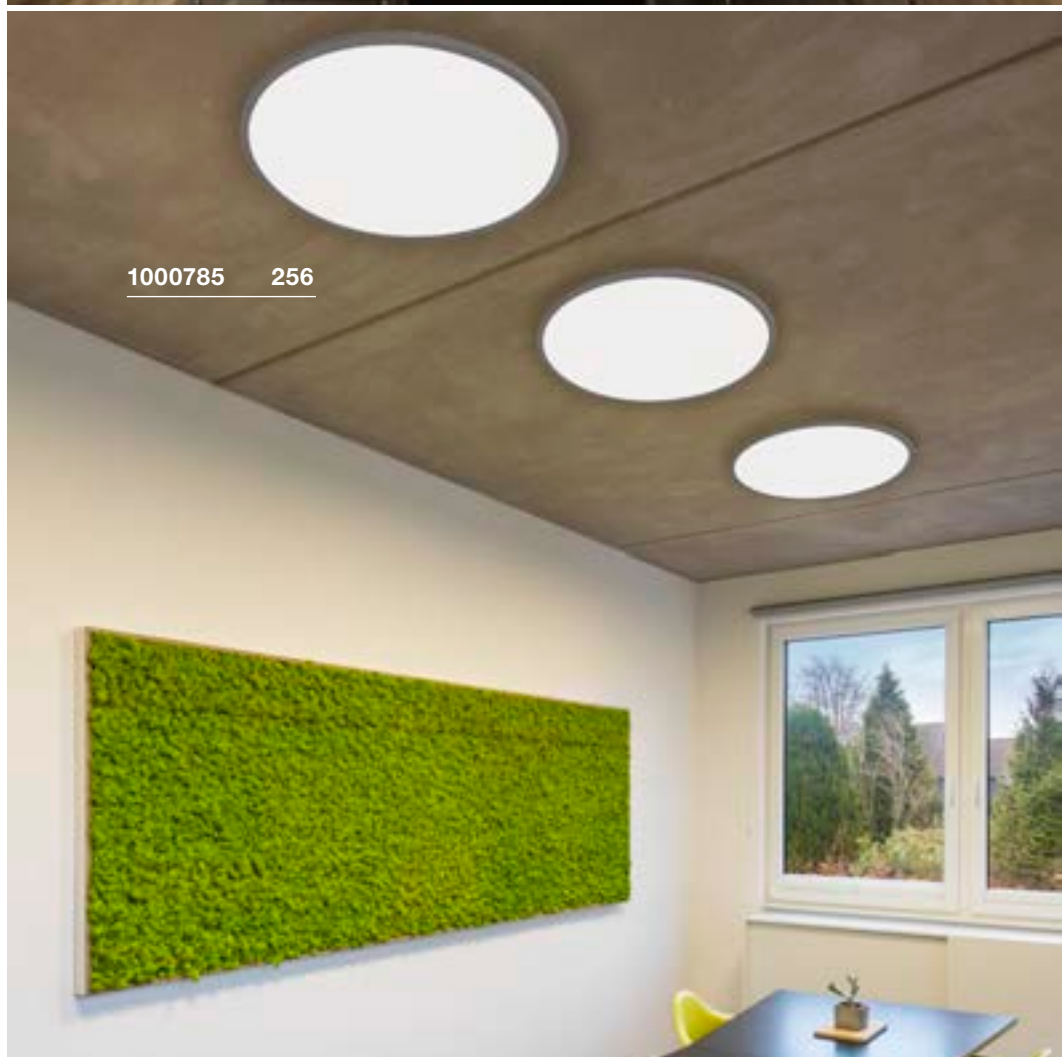

PANEL 60
CL, round, DALI

A-A++ Range A++-E

LED INSIDE

NEW VARIANT



- Panel can be surface mounted or partially recessed

Product details

100-277V ~50/60Hz | 1000mA
 Total consumption: 42W
 Material: Aluminium / Polymethylacrylate (PMMA)
 Installation dimensions:
 Installation Ø: 20 cm D: 7 cm
 Dimmable: Dali

5 22

30000 110° 40

Dimensioned drawing

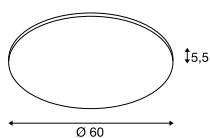

PANEL
CL, 1200x300mm, TRIAC

A-A++ Range A++-E

LED INSIDE

NEW VARIANT

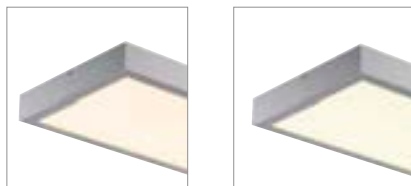
- UGR<19
- Suitable for screen workplaces in accordance with EN 12464-1

Product details

220-240V ~50/60Hz | 1000mA
 Total consumption: 45W
 Material: Aluminium / Polymethylacrylate (PMMA)
 Dimmable: Triac C

4.35 19

30000 90° 40

Dimensioned drawing

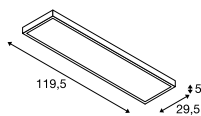

PANEL
CL, 1200x300mm, DALI

A-A++ Range A++-E

LED INSIDE

NEW VARIANT

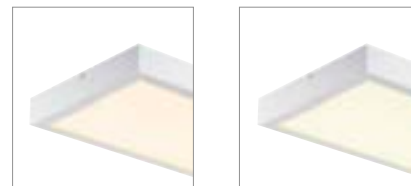
- UGR<19
- Suitable for screen workplaces in accordance with EN 12464-1

Product details

100-277V ~50/60Hz | 1000mA
 Total consumption: 45W
 Material: Aluminium / Polymethylacrylate (PMMA)
 Dimmable: Dali

4.35 19

30000 90° 40

Dimensioned drawing

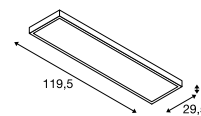

Variant	Item no.
3150lm 3000K CRI>80	
□ white	1003040
3350lm 4000K CRI>80	
□ white	1003041
3150lm 3000K CRI>80	
■ grey	1003042
3350lm 4000K CRI>80	
■ grey	1003043

Variant	Item no.
3100lm 3000K CRI>80	
□ white	1001505
3400lm 4000K CRI>80	
□ white	1001506
3100lm 3000K CRI>80	
■ grey	1001508
3400lm 4000K CRI>80	
■ grey	1001509

Variant	Item no.
3100lm 3000K CRI>80	
□ white	1003052
3400lm 4000K CRI>80	
□ white	1003053
3100lm 3000K CRI>80	
■ grey	1003054
3400lm 4000K CRI>80	
■ grey	1003055

RASTO 120/150
CL, double

A-A++ Range A++-E

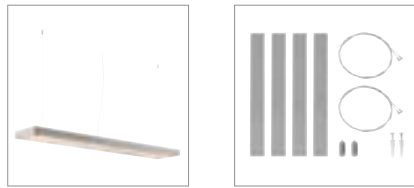

RASTO 125/155
CL, double

A-A++ Range A++-E

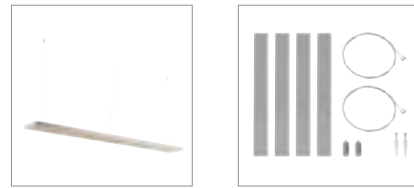

- UGR<19
- Suitable for screen workplaces in accordance with EN 12464-1

Product details

220-240V ~50/60Hz | 775mA
Material: Aluminium / Steel

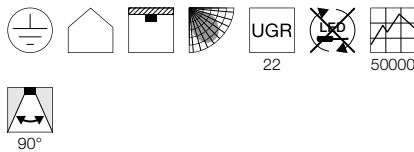

Dimensioned drawing

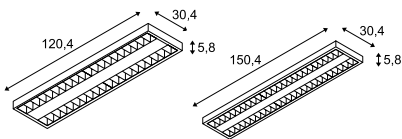

Note

Optional suspension set available as accessory.

Recommended accessories

■ Suspension set 1.5m
Item no. 158969

Variant	Item no.
3900lm 3000K CRI>80 36W L: 120.4 cm 4.7 kg	
□ white	158941
6400lm 3000K CRI>80 60W L: 150.4 cm 5.5 kg	
□ white	158951

Product details

220-240V ~50/60Hz | 300mA
Material: Aluminium / Steel

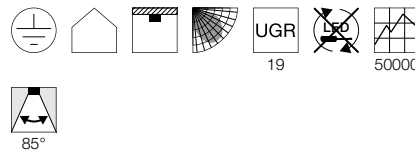

Dimensioned drawing

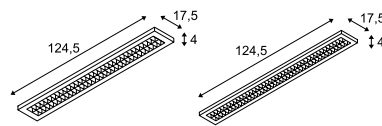

Note

Optional suspension set available as accessory.

Recommended accessories

■ Suspension set 1.5m
Item no. 158969

Variant	Item no.
4100lm 3000K CRI>80 36W L: 124.5 cm 2.8 kg	
□ white	158961
4900lm 3000K CRI>80 44W L: 154.5 cm 3.4 kg	
□ white	158971

158951 258



158961 258





1000689 259

Q-LINE®
CL, 1m, BAP



A-A++ Range A++-E



- Premium LED with CRI>90

Product details

220-240V ~50/60Hz | 900mA
Total consumption: 45W
Material: Aluminium / Plastic
Dimmable: Triac L

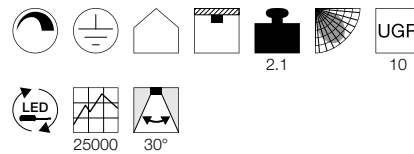

Dimensioned drawing

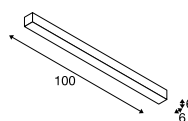

1000692 259

Q-LINE®
CL, 2m, BAP



A-A++ Range A++-E



- Premium LED with CRI>90

Product details

220-240V ~50/60Hz | 900mA
Total consumption: 85W
Material: Aluminium / Plastic
Dimmable: Triac L

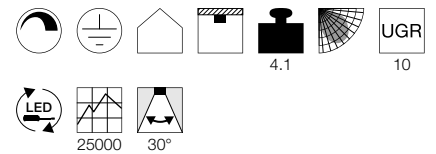

Dimensioned drawing

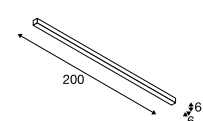

Variant	Item no.
2100lm 3000K CRI>90	
□ white	1000685
2100lm 3000K CRI>90	
■ black	1000686
2100lm 3000K CRI>90	
■ grey	1000687
2300lm 4000K CRI>90	
□ white	1000688
2300lm 4000K CRI>90	
■ black	1000689
2300lm 4000K CRI>90	
■ grey	1000690

Variant	Item no.
4200lm 3000K CRI>90	
□ white	1000691
4200lm 3000K CRI>90	
■ black	1000692
4200lm 3000K CRI>90	
■ grey	1000693
4600lm 4000K CRI>90	
□ white	1000694
4600lm 4000K CRI>90	
■ black	1000695
4600lm 4000K CRI>90	
■ grey	1000696

ROTOBALL 25
CL, E27



A-A++ Range A++-E



Product details

230V ~50Hz
Material: Steel / Polyethylene (PE)

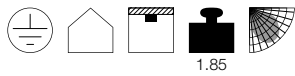

Dimensioned drawing

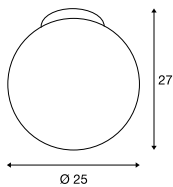

Recommended lamp

LED E27 14.5W 200°
2700K 1521lm EEL=A+
15kWh/1000h
Item no. 560422



LED E27 9W 240°
2700-6500K 806lm EEL=A+
9kWh/1000h
Item no. 1001916



Lamp details

max. 24W
Ø: 9.5 cm max.

Variant	Item no.
E27	
□ white	1002051

ROTOBALL 40
CL, E27



A-A++ Range A++-E



Product details

230V ~50Hz
Material: Steel / Polyethylene (PE)

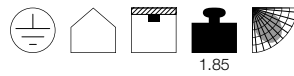

Dimensioned drawing

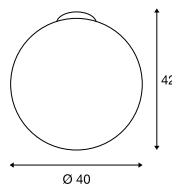

Recommended lamp

LED E27 14.5W 200°
2700K 1521lm EEL=A+
15kWh/1000h
Item no. 560422



LED E27 9W 240°
2700-6500K 806lm EEL=A+
9kWh/1000h
Item no. 1001916



Lamp details

max. 24W
Ø: 9.5 cm max.

Variant	Item no.
E27	
□ white	1002052

MALANG
CL, E27

E-A++ Range A++-E

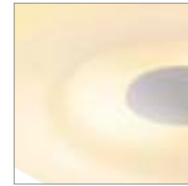
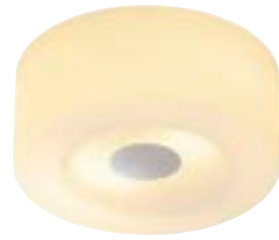

Product details

230V ~50Hz
Material: Steel / Glass

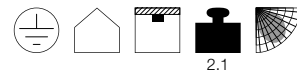

Dimensioned drawing

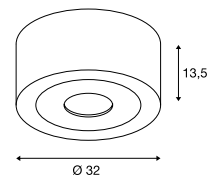

Recommended lamp

LED E27 9,1W 240°
2700K 760lm EEK=A+
10kWh/1000h
Item no. 560402



LED E27 9.5W 240°
2200-6700K 806lm EEL=A+
10kWh/1000h
Item no. 1001917



Lamp details

2x max. 60W
Ø: 5.5 cm max. L: 13.5 cm max.

Variant	Item no.
E27	
■ white / chrome	146942





DESIGNED BY
David Morgan



OCCULDAS 13
DL, indirect, TRIAC



A-A++ Range A++-E



- Glare-free, indirect light

Product details

220-240V ~50/60Hz | 350mA
Total consumption: 15W
Material: Aluminium
Dimmable: Triac C

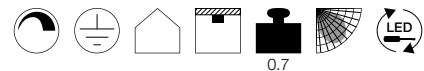

0.7

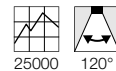

25000 120°

Dimensioned drawing

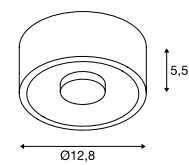

"Excellent light quality from innovative, distinctive and attractive luminaire designs."

Variant	Item no.
810lm 3000K CRI>80 □ white	117351

OCCULDAS 23
DL, indirect, TRIAC



A-A++ Range A++-E

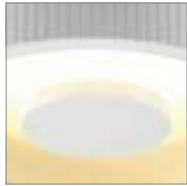

- Glare-free, indirect light

Product details

200-240V ~50/60Hz | 700mA
Total consumption: 26W
Material: Aluminium / Steel
Dimmable: Triac C, Triac L, Uni

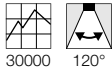
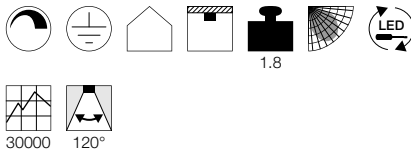

Dimensioned drawing

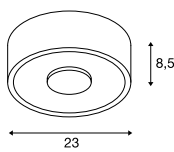

OCCULDAS 13
DL, TRIAC



A-A++ Range A++-E



Product details

220-240V ~50/60Hz | 700mA
Total consumption: 16W
Material: Aluminium
Dimmable: Triac C

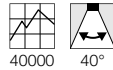

Dimensioned drawing

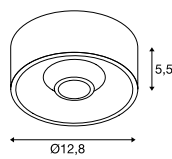

OCCULDAS 13 MOVE
DL, TRIAC



A-A++ Range A++-E



- Adjustable spot

Product details

220-240V ~50/60Hz | 350mA
Total consumption: 7.8W
Material: Aluminium / Steel
Dimmable: Triac C

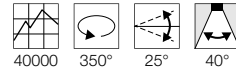
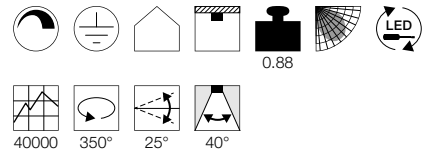

Dimensioned drawing

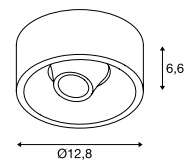

Variant	Item no.
1500lm 3000K CRI>80 □ white	117321

Variant	Item no.
1200lm 3000K CRI>80 □ white	117381

Variant	Item no.
700lm 3000K CRI>80 □ white	117361

ASTINA
CL



NAGY 75
CL, QPAR51

A-A++ Range
A++-E



A-A++ Range
A++-E



NEW



NEW



- High-quality, frosted glass

- Can be individually designed with colours, stickers and more

Product details

220-240V ~50/60Hz
Material: Aluminium

Product details

220-240V ~50/60Hz
Material: Plaster
Product dimensions: Ø: 7.5 cm H: 14 cm

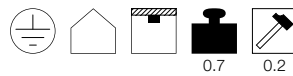
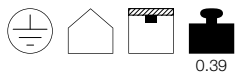

Dimensioned drawing

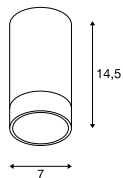

Recommended lamp

LED GU10 7.2W 36°
4000K 540lm EEL=A+
8kWh/1000h
Item no. 1001565



Recommended lamp

LED GU10 7.2W 36°
4000K 540lm EEL=A+
8kWh/1000h
Item no. 1001565



LED GU10 5.5W 38°
2700K 400lm EEL=A+
6kWh/1000h
Item no. 1001030



LED GU10 5.5W 38°
2700K 400lm EEL=A+
6kWh/1000h
Item no. 1001030



Lamp details

max. 10W QPAR51

Lamp details

max. 10W QPAR51

Variant	Item no.
GU10 QPAR51 □ matt white	1002934
GU10 QPAR51 ■ matt grey	1002935
GU10 QPAR51 ■ matt black	1002936

Variant	Item no.
GU10 QPAR51 □ matt white	1002965

1002965 264



1002935 264

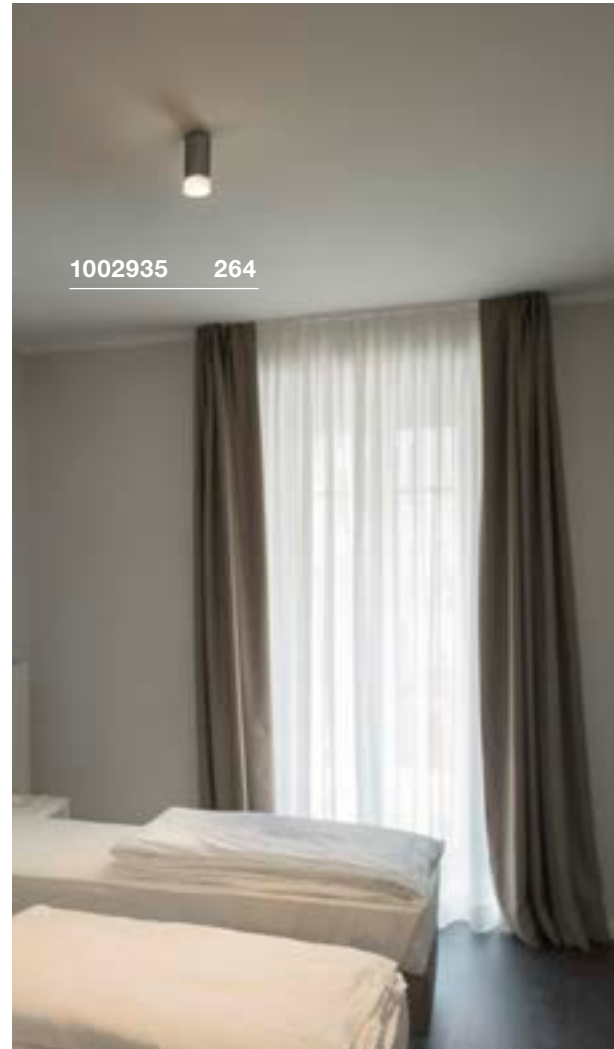

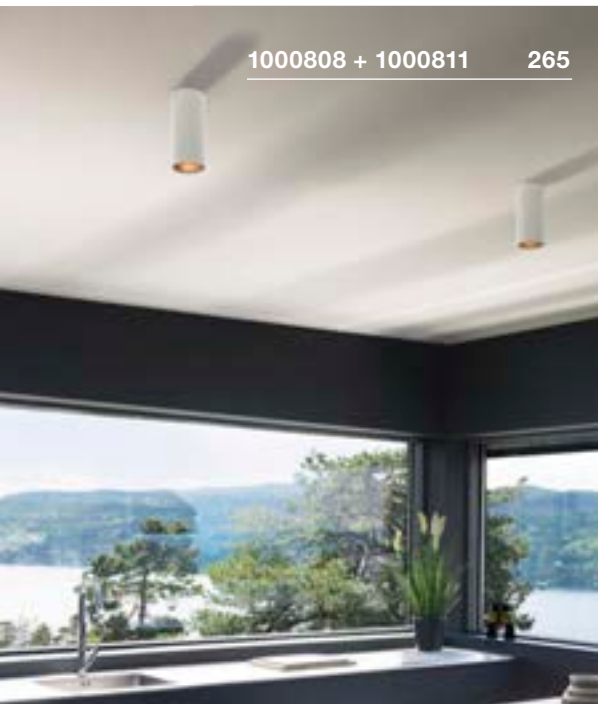

1000808 + 1000811 265



151810 265

ENOLA B
CL, QPAR51



E-A++ Range A++-E



ANELA
CL



A-A++ Range A++-E



- Premium LED with CRI>90
- Reduced glare
- Coloured reflectors available as accessories

Product details

220-240V ~50/60Hz
Material: Aluminium / Steel



Dimensioned drawing

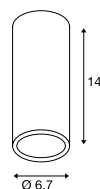

Recommended accessories

■ Deco ring
Item no. 151840



Recommended lamp

GU10 5.5W 36°
2800K 420lm EEL=A+
6kWh/1000h
Item no. 1001217



LED GU10 7.2W 36°
4000K 540lm EEL=A+
8kWh/1000h
Item no. 1001565



Lamp details

max. 35W QPAR51
L: 8.5 cm max.

Variant	Item no.
GU10 QPAR51	
■ black	151810
GU10 QPAR51	
□ white	151811
GU10 QPAR51	
■ gold	151813
GU10 QPAR51	
■ grey / black	151814

Product details

220-240V ~50/60Hz | 500mA
Total consumption: 11W
Material: Aluminium
Dimmable: Triac C

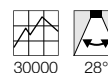
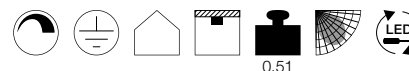

Dimensioned drawing

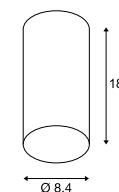

Note

Lumen output with reflector or 1000809 = 500lm
Lumen output with reflector or 1000810 = 620lm
Lumen output with reflector or 1000811 = 200lm
Lumen output with reflector or 1000812 = 600lm

Recommended accessories

■ Reflec or 28°
Item no. 1000809

■ Reflec or 28°
Item no. 1000810

■ Reflec or 28°
Item no. 1000811

□ Reflec or 28°
Item no. 1000812

Variant	Item no.
200-620lm 3000K CRI>90	
■ black	1000807
200-620lm 3000K CRI>90	
□ white	1000808



Reflec or 28° – the reflector of this luminaire can be replaced, giving you a different lighting effect because of the different colours (gold, grey, black and white).

ROX
CL, QPAR111



E-A++ Range A++-E

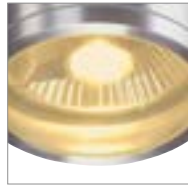

- High-quality brushed finis

Product details

230V ~50Hz
Material: Aluminium / Glass



Dimensioned drawing

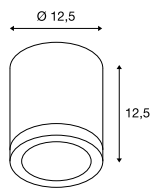

Recommended lamp

GU10 7.9W 25°
2700K 730lm EEL=A+
8kWh/1000h
Item no. 560702



LED GU10 9W 25°
2700-6500K 765lm EEL=A+
9kWh/1000h
Item no. 1001920



Lamp details

max. 50W QPAR111

Variant	Item no.
GU10 QPAR111	
brushed aluminium	1000332

ENOLA C
CL



A-A++ Range A++-E

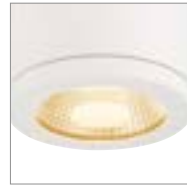

- Premium LED with CRI>90
- Dim to warm
- Light colour changes when dimming

Product details

220-240V ~50/60Hz | 350mA
Total consumption: 15W
Material: Aluminium / Glass
Dimmable: Triac C

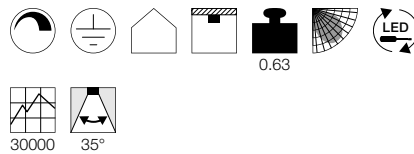

Dimensioned drawing

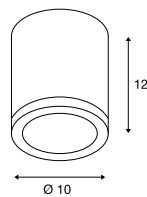

Variant	Item no.
900lm 2000-3000K CRI>90	
white	1000631

ENOLA C
CL



A-A++ Range A++-E



Product details

100-240V ~50/60Hz | 500mA
Total consumption: 12W
Material: Aluminium / Glass

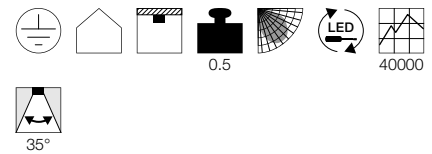

Dimensioned drawing

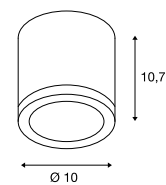

Variant	Item no.
850lm 3000K CRI>80	
white	152101



151514 267



151531 267

ALTRA DICE
CL, QPAR51



E-A++ Range A++-E



Product details

220-240V ~50/60Hz
Material: Aluminium / Steel

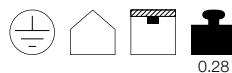

Dimensioned drawing

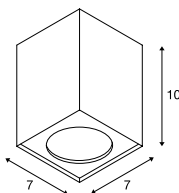

Recommended lamp

LED GU10 5.5W 38°
2700K 400lm EEL=A+
6kWh/1000h
Item no. 1001030



LED GU10 5.5W 36°
2800K 420lm EEL=A+
6kWh/1000h
Item no. 1001217



Lamp details

max. 35W QPAR51

Variant	Item no.
GU10 QPAR51 □ white	151511
GU10 QPAR51 ■ grey / black	151514
GU10 QPAR51 ■ black	1002216

ALTRA DICE
CW, double, QPAR51



E-A++ Range A++-E



Product details

220-240V ~50/60Hz
Material: Aluminium / Steel

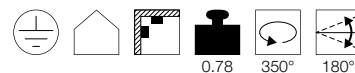

Dimensioned drawing

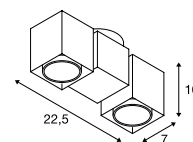

Recommended lamp

LED GU10 4.3W 40°
3000K 375lm EEL=A++
5kWh/1000h
Item no. 560143



LED GU10 5.5W 36°
2800K 420lm EEL=A+
6kWh/1000h
Item no. 1001217



Lamp details

2x max. 50W QPAR51

Variant	Item no.
GU10 QPAR51 □ white	151531
GU10 QPAR51 ■ grey / black	151534
GU10 QPAR51 ■ black	1002215

TEC KALU
CL, double, TRIAC



A-A++ Range A++-E

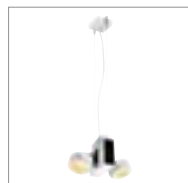

- Can be converted into a pendant using the optional suspension set
- Spots rotatable by 360° and tiltable by 120°
- Entire luminaire rotatable by 360°

Product details

220-240V ~50/60Hz | 700mA
Total consumption: 31W
Material: Aluminium / Polycarbonate (PC)
Dimmable: Triac C

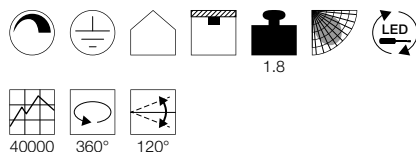

Dimensioned drawing

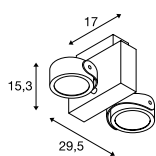

Recommended accessories

- Suspension set 1.5m
Item no. **1001435**
- Suspension set 1.5m
Item no. **1001436**

Variant	Item no.
1900lm 3000K CRI>80 24° ■ black	1001431
1900lm 3000K CRI>80 24° ■ white / black	1001432
1900lm 3000K CRI>80 60° ■ black	1001423
1900lm 3000K CRI>80 60° ■ white / black	1001424

TEC KALU
CL, quad, TRIAC



A-A++ Range A++-E



- Can be converted into a pendant using the optional suspension set
- Spots rotatable by 360° and tiltable by 120°
- Entire luminaire rotatable by 360°

Product details

220-240V ~50/60Hz | 700mA
Total consumption: 60W
Material: Aluminium / Polycarbonate (PC)
Dimmable: Triac C

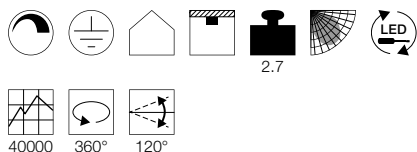

Dimensioned drawing

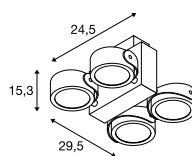

Recommended accessories

- Suspension set 1.5m
Item no. **1001435**
- Suspension set 1.5m
Item no. **1001436**

Variant	Item no.
3800lm 3000K CRI>80 24° ■ black	1001433
3800lm 3000K CRI>80 24° ■ white / black	1001434
3800lm 3000K CRI>80 60° ■ black	1001425
3800lm 3000K CRI>80 60° ■ white / black	1001426

1001426 268



1001434 + 1001436 268



1002011 269



1002004 269

TRILEDO
CL, single, round, QPAR51

E-A++ Range A++-E



Product details

220-240V ~50/60Hz
Material: Aluminium

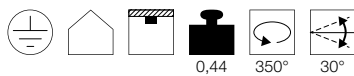

Dimensioned drawing

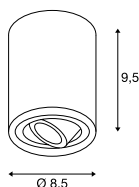

Recommended lamp

LED GU10 7.2W 36°
2700K 470lm EEL=A+
8kWh/1000h
Item no. 560552



LED GU10 5.5W 38°
2700K 400lm EEL=A+
6kWh/1000h
Item no. 1001030



Lamp details

max. 10W LED GU10 51mm
Ø: 5 cm max. L: 5.5 cm max.

Variant	Item no.
GU10 LED GU10 51mm	
white	1002011
GU10 LED GU10 51mm	
brushed aluminium	1002012
GU10 LED GU10 51mm	
black	1002010

TRILEDO
CL, single, square, QPAR51

E-A++ Range A++-E



Product details

220-240V ~50/60Hz
Material: Aluminium

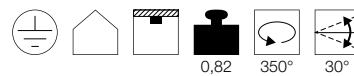

Dimensioned drawing

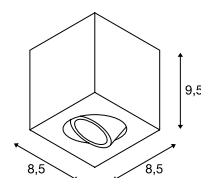

Recommended lamp

LED GU10 7.2W 36°
4000K 540lm EEL=A+
8kWh/1000h
Item no. 1001566



LED GU10 5.5W 36°
2800K 420lm EEL=A+
6kWh/1000h
Item no. 1001217



Lamp details

max. 10W LED GU10 51mm
Ø: 5 cm max. L: 5.5 cm max.

Variant	Item no.
GU10 LED GU10 51mm	
white	1002015
GU10 LED GU10 51mm	
brushed aluminium	1002004
GU10 LED GU10 51mm	
black	1002013

TRILEDO
CL, double, square, QPAR51

E-A++ Range A++-E



Product details

220-240V ~50/60Hz
Material: Aluminium

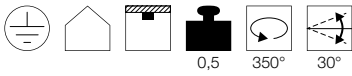

Dimensioned drawing

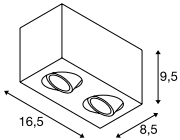

Recommended lamp

LED GU10 7.2W 36°
4000K 540lm EEL=A+
8kWh/1000h
Item no. 1001566



LED GU10 5.5W 36°
2800K 420lm EEL=A+
6kWh/1000h
Item no. 1001217



Lamp details

2x max. 10W LED GU10 51mm
Ø: 5 cm max. L: 5.5 cm max.

Variant	Item no.
GU10 LED GU10 51mm	
<input type="checkbox"/> white	1002006
GU10 LED GU10 51mm	
<input checked="" type="checkbox"/> black	1002005

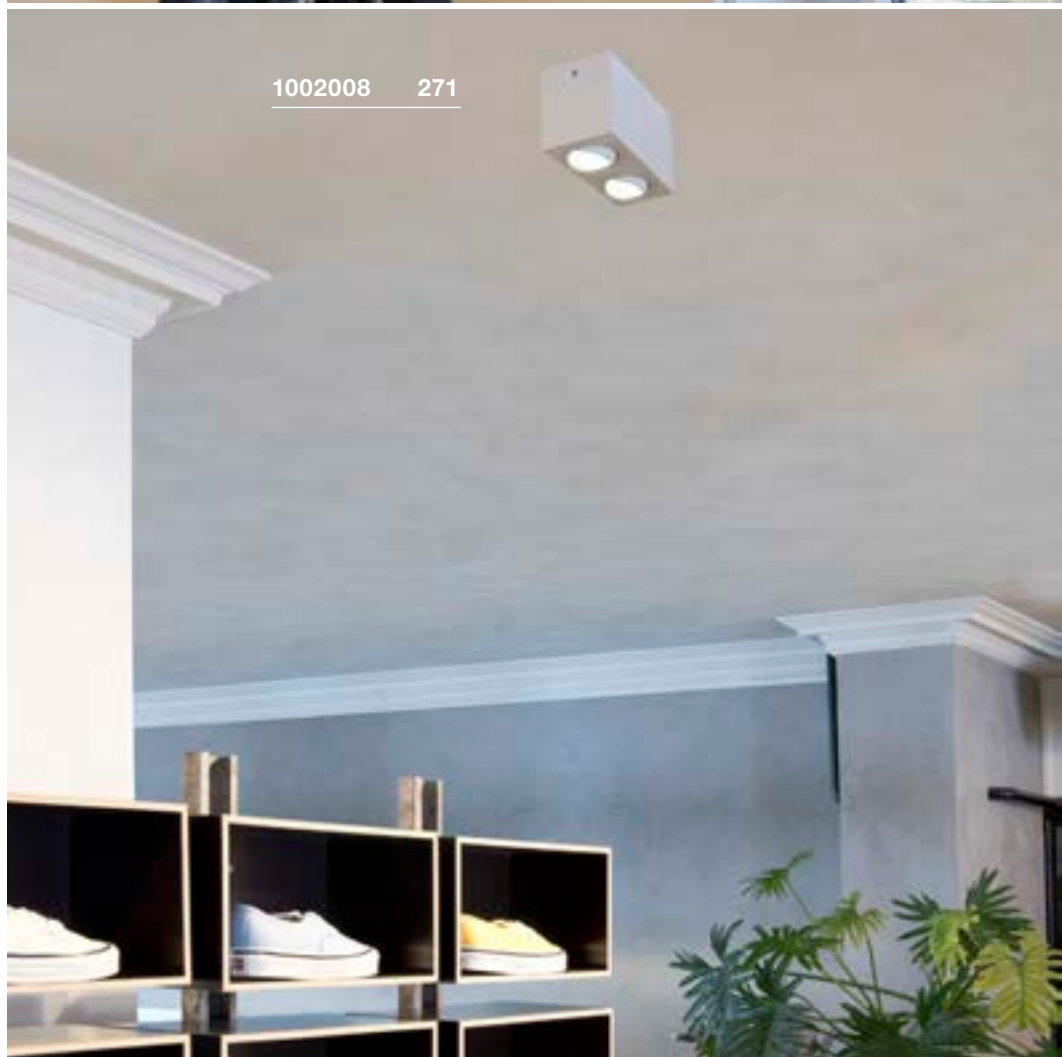
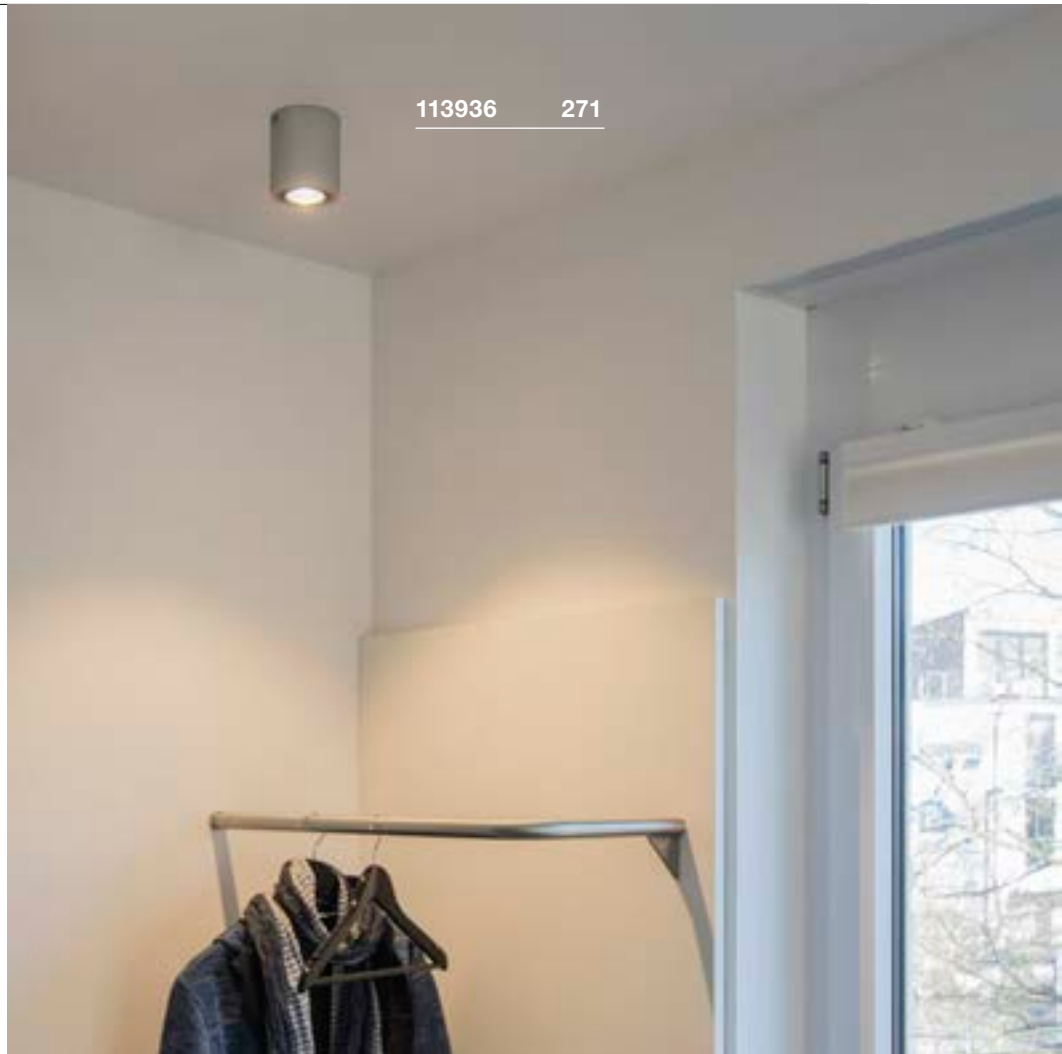

TRILEDO
CL, single, round



Product details

100-240V ~50/60Hz | 350mA
Total consumption: 8.1W
Material: Aluminium

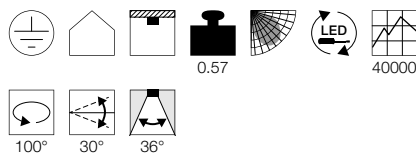

Dimensioned drawing

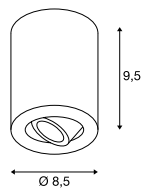

Variant	Item no.
670lm 3000K CRI>80 □ white	113931
670lm 3000K CRI>80 ▒ matt aluminium	113936
670lm 3000K CRI>80 ■ matt black	113930

TRILEDO
CL, single, square

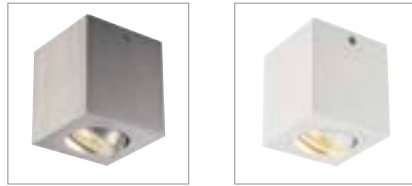

Product details

100-240V ~50/60Hz | 350mA
Total consumption: 8.1W
Material: Aluminium

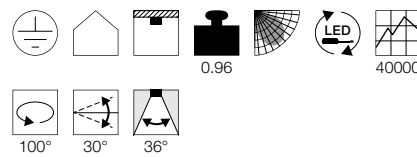

Dimensioned drawing

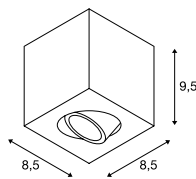

Variant	Item no.
670lm 3000K CRI>80 □ white	113941
670lm 3000K CRI>80 ▒ matt aluminium	113946
670lm 3000K CRI>80 ■ matt black	113940

TRILEDO
CL, double, square



Product details

220-240V ~50/60Hz | 350mA
Total consumption: 14W
Material: Aluminium

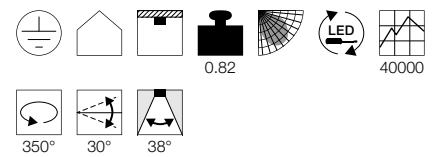

Dimensioned drawing

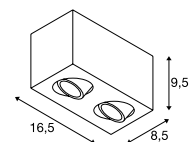

Variant	Item no.
1100lm 3000K CRI>80 □ white	1002008
1100lm 3000K CRI>80 ■ black	1002003

PLASTRA
CL, QPAR51



E-A++ Range A++-E



- Can be individually designed with colours, stickers and more

Product details

220-240V ~50/60Hz
Material: Plaster / Steel

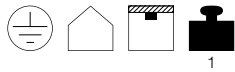

Dimensioned drawing

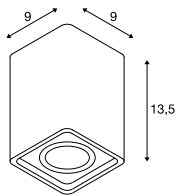

Recommended lamp

GU10 5.5W 36°
2800K 420lm EEL=A+
6kWh/1000h
Item no. 1001217



LED GU10 7.2W 36°
2700K 470lm EEL=A+
8kWh/1000h
Item no. 560552



Lamp details

max. 35W QPAR51

Variant	Item no.
GU10 QPAR51	
□ white	148004

PLASTRA 15
CL, single, QPAR51



E-A++ Range A++-E



- Can be individually designed with colours, stickers and more

Product details

220-240V ~50/60Hz
Material: Plaster / Steel

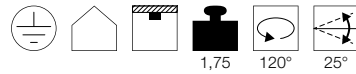

Dimensioned drawing

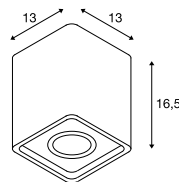

Recommended lamp

LED GU10 5.5W 38°
2700K 400lm EEL=A+
6kWh/1000h
Item no. 1001030



LED GU10 7W 25/40/55°
3000K 300lm EEL=A
7kWh/1000h
Item no. 560603



Lamp details

max. 35W QPAR51

Variant	Item no.
GU10 QPAR51	
□ white	148051

148004 272



148051 272

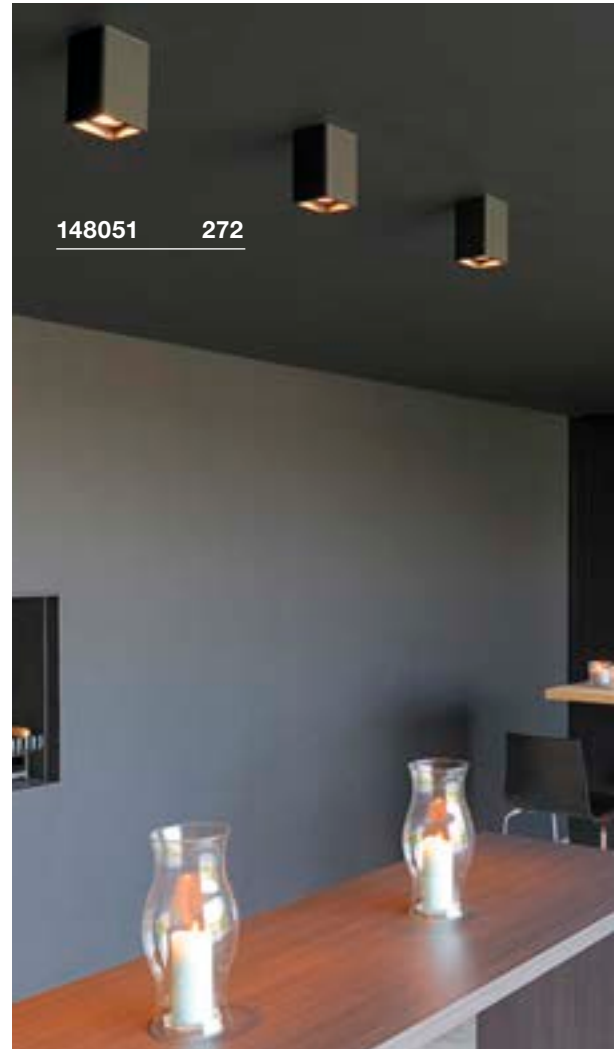



148052 273



148053 273

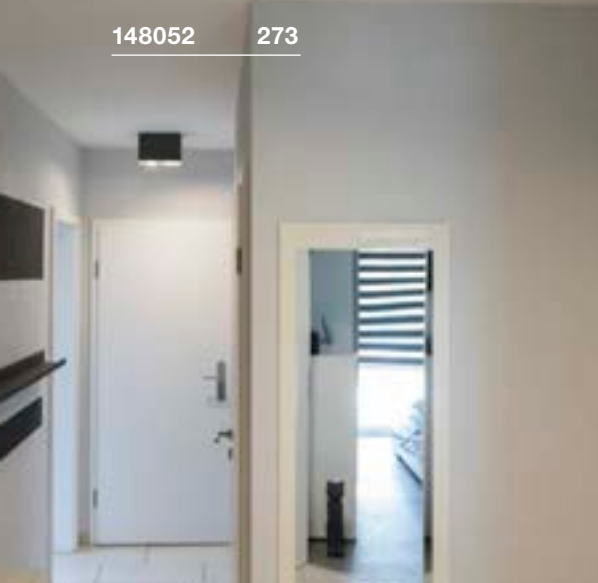

148052 273

PLASTRA 25
CL, double, QPAR51



E-A++ Range A++-E



- Can be individually designed with colours, stickers and more

Product details

220-240V ~50/60Hz
Material: Plaster / Steel

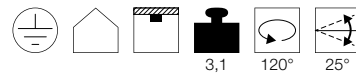

Dimensioned drawing

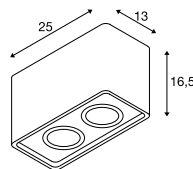

PLASTRA 35
CL, triple, QPAR51



E-A++ Range A++-E



- Can be individually designed with colours, stickers and more

Product details

220-240V ~50/60Hz
Material: Plaster / Steel

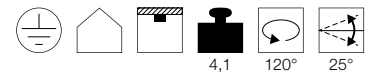

Dimensioned drawing

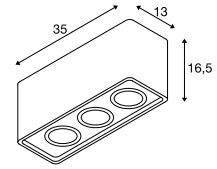

Recommended lamp

LED GU10 5.5W 38°
2700K 400lm EEL=A+
6kWh/1000h
Item no. 1001030



LED GU10 7.2W 36°
2700K 470lm EEL=A+
8kWh/1000h
Item no. 560552



Lamp details

2x max. 35W QPAR51

Variant	Item no.
GU10 QPAR51 □ white	148052

Recommended lamp

LED GU10 7.2W 36°
4000K 540lm EEL=A+
8kWh/1000h
Item no. 1001564



LED GU10 7W 25/40/55°
3000K 300lm EEL=A
7kWh/1000h
Item no. 560603



Lamp details

3x max. 35W QPAR51

Variant	Item no.
GU10 QPAR51 □ white	148053

KARDAMOD
CL, square, single, QPAR111



Product details

230V ~50Hz
Material: Steel

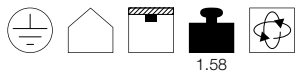

Dimensioned drawing

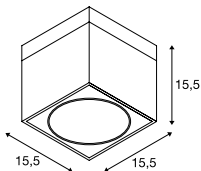

Recommended lamp

GU10 6.5W 38°
2700K 390lm EEL=A+
7kWh/1000h
Item no. 551882



LED GU10 6.5W 30°
3000K 420lm EEL=A+
7kWh/1000h
Item no. 551912



Lamp details

max. 75W QPAR111

Variant	Item no.
GU10 QPAR111	
■ matt black	117100
GU10 QPAR111	
□ white	117101

KARDAMOD
CL, square, double, QPAR111



Product details

230V ~50Hz
Material: Steel

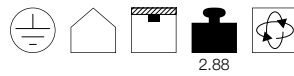

Dimensioned drawing

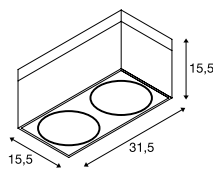

Recommended lamp

LED GU10 13W 30°
4000K 1300lm EEL=A+
13kWh/1000h
Item no. 1001243



LED GU10 13W 140°
4000K 1100lm EEL=A+
13kWh/1000h
Item no. 1001245



Lamp details

2x max. 75W QPAR111

Variant	Item no.
GU10 QPAR111	
■ matt black	117110
GU10 QPAR111	
□ white	117111

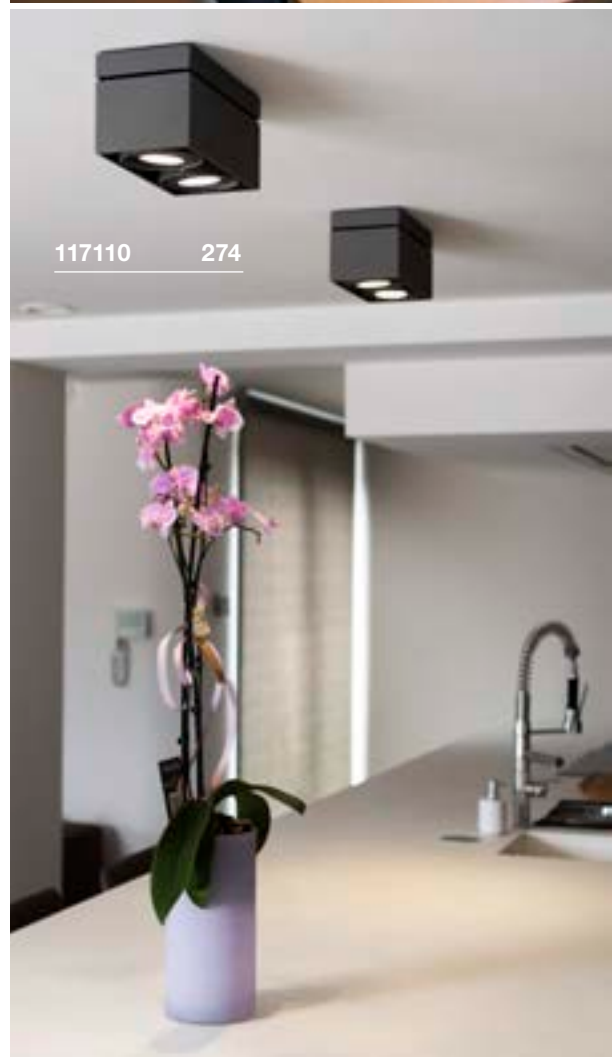



117111 274

KARDAMOD
CL, square, single, QR111

D-A+ Range A++-E



Product details

230V ~50Hz | 12V AC
Material: Steel
Dimmable: C

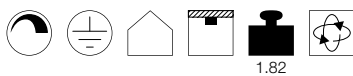

1.82

Dimensioned drawing

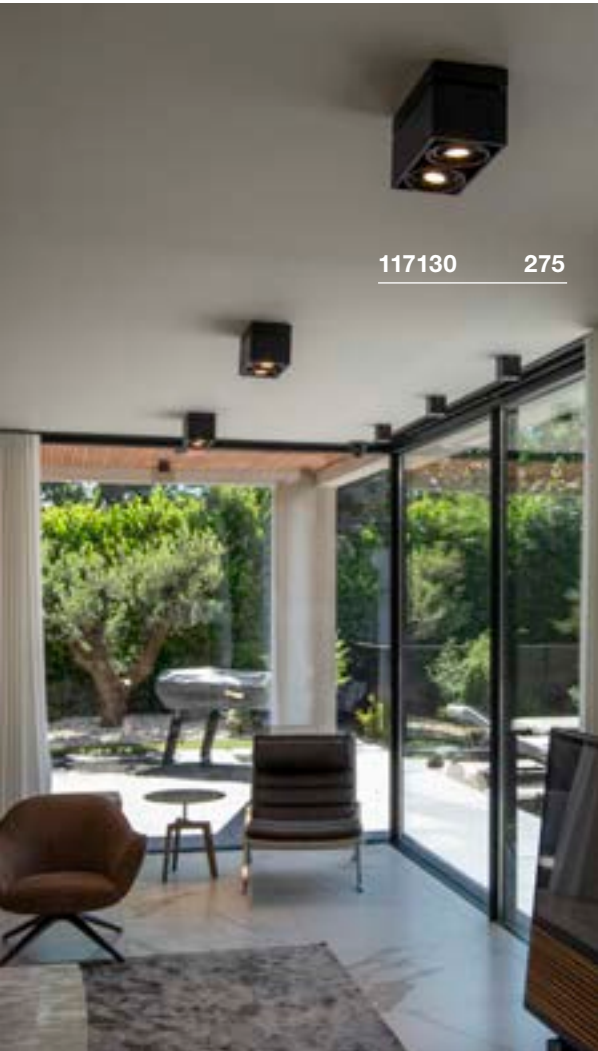
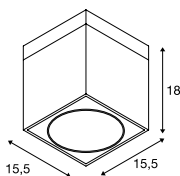

117130 275

KARDAMOD
CL, square, double, QR111

E-A++ Range A++-E



Product details

230V ~50Hz | 12V AC
Material: Steel
Dimmable: C

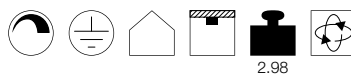

2.98

Dimensioned drawing

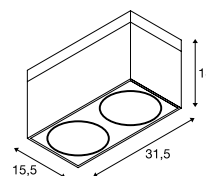

Recommended lamp

LED G53 15W 24°
2700K 760lm EEL=A
17kWh/1000h
Item no. 560231



LED G53 15W 40°
2700K 750lm EEL=A
17kWh/1000h
Item no. 560232



Lamp details

max. 75W QR111

Variant	Item no.
G53 QR111	
■ matt black	117120
G53 QR111	
□ white	117121

Recommended lamp

LED G53 15W 24°
2700K 760lm EEL=A
17kWh/1000h
Item no. 560231



LED G53 15W 40°
2700K 750lm EEL=A
17kWh/1000h
Item no. 560232



Lamp details

2x max. 50W QR111

Variant	Item no.
G53 QR111	
■ matt black	117130
G53 QR111	
□ white	117131

KARDAMOD
CL, round, single, QPAR111



Product details

230V ~50Hz
Material: Steel

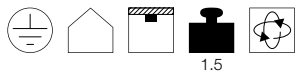

Dimensioned drawing

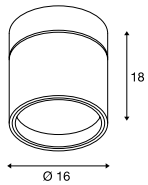

Recommended lamp

GU10 6.5W 38°
2700K 390lm EEL=A+
7kWh/1000h
Item no. 551882



LED GU10 6.5W 30°
3000K 420lm EEL=A+
7kWh/1000h
Item no. 551912



Lamp details

max. 75W QPAR111

Variant	Item no.
GU10 QPAR111	
■ matt black	117160
GU10 QPAR111	
□ white	117161

KARDAMOD
CL, round, double, QPAR111



Product details

230V ~50Hz
Material: Steel

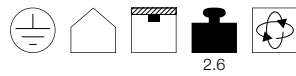

Dimensioned drawing

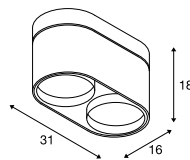

Recommended lamp

LED GU10 13W 30°
4000K 1300lm EEL=A+
13kWh/1000h
Item no. 1001243



LED GU10 13W 140°
4000K 1100lm EEL=A+
13kWh/1000h
Item no. 1001245



Lamp details

2x max. 75W QPAR111

Variant	Item no.
GU10 QPAR111	
■ matt black	117180
GU10 QPAR111	
□ white	117181

117181 276



114181 277



SUPROS CL  897

A-A++ Range A++-E



Product details

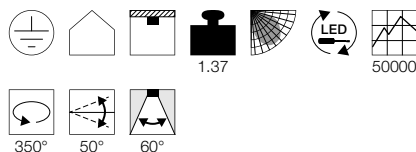

220-240V ~50/60Hz | 950mA
Total consumption: 36W
Material: Aluminium / Glass

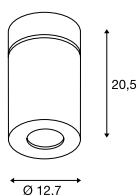

Dimensioned drawing



Recommended accessories

- Reflec or 20° 
- Item no. 114102
- Reflec or 40° 
- Item no. 114104

Variant	Item no.
3100lm 3000K CRI>80	
■ black	118130
3100lm 3000K CRI>80	
□ white / transparent	118131
3300lm 4000K CRI>80	
■ black	118180
3300lm 4000K CRI>80	
□ white / transparent	118181

SUPROS 78 CL, TRIAC  897

A-A++ Range A++-E



Product details

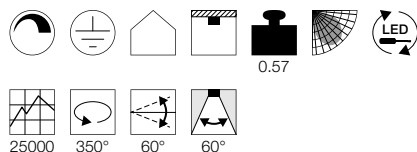

220-240V ~50/60Hz | 250mA
Total consumption: 12W
Material: Aluminium
Dimmable: Triac C, Triac L

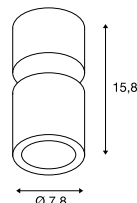

Dimensioned drawing



Recommended accessories

- Lens, 20° 
- Item no. 116302
- Lens, 40° 
- Item no. 116304

Variant	Item no.
700lm 3000K CRI>80	
■ black	116330
700lm 3000K CRI>80	
□ white	116331

SUPROS CL, Move  897

A-A++ Range A++-E



Product details

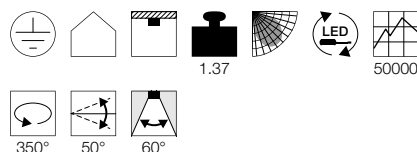

220-240V ~50/60Hz | 750mA
Total consumption: 31W
Material: Aluminium / Glass

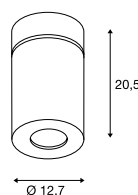

Dimensioned drawing



Recommended accessories

- Reflec or 20° 
- Item no. 114102
- Reflec or 40° 
- Item no. 114104

Variant	Item no.
2850lm 4000K CRI>80	
■ black	114180
2850lm 4000K CRI>80	
□ white / transparent	114181
2600lm 3000K CRI>80	
■ black	114130
2600lm 3000K CRI>80	
□ white / transparent	114131

FOR THAT RADIANT LOOK.

COMBINATION OF WALL AND CEILING LIGHTS.

Whereas ceiling lights call the tune with regard to general lighting, wall luminaires create individual impressions. A combination of the two is therefore ideal for an integrated light solution – providing many varying options; there are no limits to your creativity.

1000887 299



1002974 297



WALL AND CEILING LIGHTS

 282	 283	 283	 284	 285	 286	 286	 287
 288	 289	 289	 290	 290	 291	 291	 292
 292	 295	 295	 295	 297	 297	 297	 299
 299	 299	 299	 301	 301	 301	 301	 303
 303	 303	 303	 304	 304	 304	 304	 306
 306	 306	 307	 307	 307	 310	 310	 310
 311	 311	 311	 312	 312	 312	 313	 313
 314	 315	 315	 315	 316	 317	 317	 318
 319	 319	 319	 321	 321	 321	 322	 324
 324	 324	 325	 325	 325	 327	 327	 328
 328	 329	 329					

 Other luminaires and variants can be found online at www.slv.com

SPOT
CW, E27



D-A+ Range
A++-E



1002072 282

Product details

230V ~50Hz
Material: Aluminium

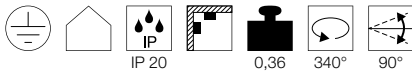

IP 20

0,36

340°

90°

Dimensioned drawing

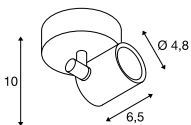

Recommended lamp

LED E27 11,5W 38°
3000K 760lm EEL=A+
12kWh/1000h
Item no. 551933



LED E27 17W 45°
3000K 1430lm EEL=A+
17kWh/1000h
Item no. 560473



Lamp details

max. 75W QPAR20
optional: QPAR30

Variant	Item no.
E27 QPAR20	
■ black	1002072
E27 QPAR20	
□ white	1002073
E27 QPAR20	
■ grey	1002074





132020 283

SPOT 79
CW, QPAR51

E-A++ Range A++-E

■ black □ white ▒ grey

🏠+



Product details

230V ~50Hz
Material: Aluminium

⊕ □ ▒ ■ ↻ ↺

0.25 350° 180°

Dimensioned drawing

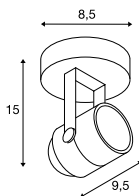

Recommended lamp

LED GU10 5.5W 38°
2700K 400lm EEL=A+
6kWh/1000h
Item no. 1001030



LED GU10 7.2W 36°
2700K 470lm EEL=A+
8kWh/1000h
Item no. 560552



Lamp details

max. 50W QPAR51
Ø: 5 cm max. L: 5.7 cm max.

Variant	Item no.
GU10 QPAR51	
■ black	132020
□ white	132021
▒ grey	132024

INDA
CW, QPAR51

E-A++ Range A++-E

■ black □ white ▒ grey

🏠+



Product details

230V ~50Hz
Material: Aluminium

⊕ □ ▒ ■ ↻ ↺

0.3 350° 180°

Dimensioned drawing

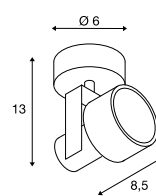

Recommended lamp

LED GU10 7.2W 36°
4000K 540lm EEL=A+
8kWh/1000h
Item no. 1001565



LED GU10 7.2W 36°
2700K 520lm EEL=A+
8kWh/1000h
Item no. 1001560



Lamp details

max. 50W QPAR51
Ø: 5 cm max. L: 5.7 cm max.

Variant	Item no.
GU10 QPAR51	
■ matt black	147550
□ matt white	147551
▒ matt aluminium	147559



147559 283

ALTRA DICE
CW, double, QPAR51



E-A++ Range A++-E



1002215 284



- Entire lamp can be rotated

Product details

220-240V ~50/60Hz
Material: Aluminium / Steel

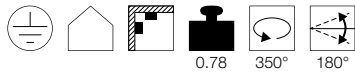

Dimensioned drawing

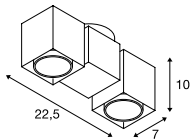

Recommended lamp

LED GU10 4.3W 40°
3000K 375lm EEL=A++
5kWh/1000h
Item no. 560143



LED GU10 5.5W 36°
2800K 420lm EEL=A+
6kWh/1000h
Item no. 1001217



Lamp details

2x max. 50W QPAR51

Variant	Item no.
GU10 QPAR51	
□ white	151531
GU10 QPAR51	
■ grey / black	151534
GU10 QPAR51	
■ black	1002215





1002585 285



1002584 285

FITU
CW, E27



E-A++ Range A++-E



Product details

220-240V ~50/60Hz
Material: Aluminium / Steel

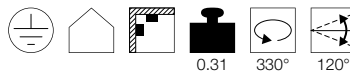

0.31 330° 120°

Dimensioned drawing

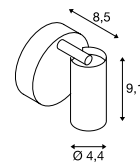

Recommended lamp

LED E27 8W 350°
2200K 250lm EEL=B
8kWh/1000h
Item no. 1001213



LED E27 10.5W 360°
2700K 1000lm EEL=A+
10.5kWh/1000h
Item no. 1001756



Lamp details

max. 60W

Variant	Item no.
E27	
white	1002584
E27	
black	1002585

KARPO 30
CW, single



A-A++ Range A++-E



- Premium LED with CRI>90

Product details

100-240V ~50/60Hz | 500mA
Total consumption: 9.5W
Material: Aluminium / Steel

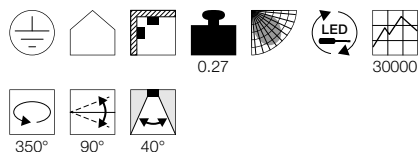

Dimensioned drawing

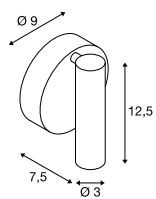

KARPO 30
CW, single, TRIAC



A-A++ Range A++-E

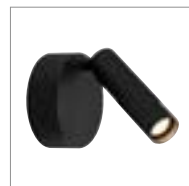

- Premium LED with CRI>90
- Dimmable

Product details

220-240V ~50/60Hz | 500mA
Total consumption: 9W
Material: Aluminium / Steel
Dimmable: Triac C

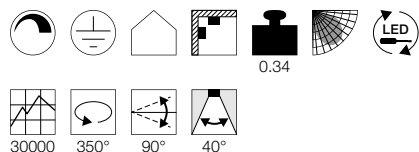

Dimensioned drawing

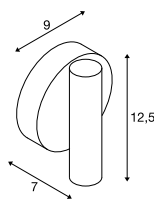

Variant	Item no.
480lm 3000K CRI>90	
■ black	152330
530lm 3000K CRI>90	
□ white	152331
530lm 3000K CRI>90	
■ gold	1002175

Variant	Item no.
580lm 3000K CRI>90	
■ black	1001495
600lm 3000K CRI>90	
□ white	1001496

152331 286

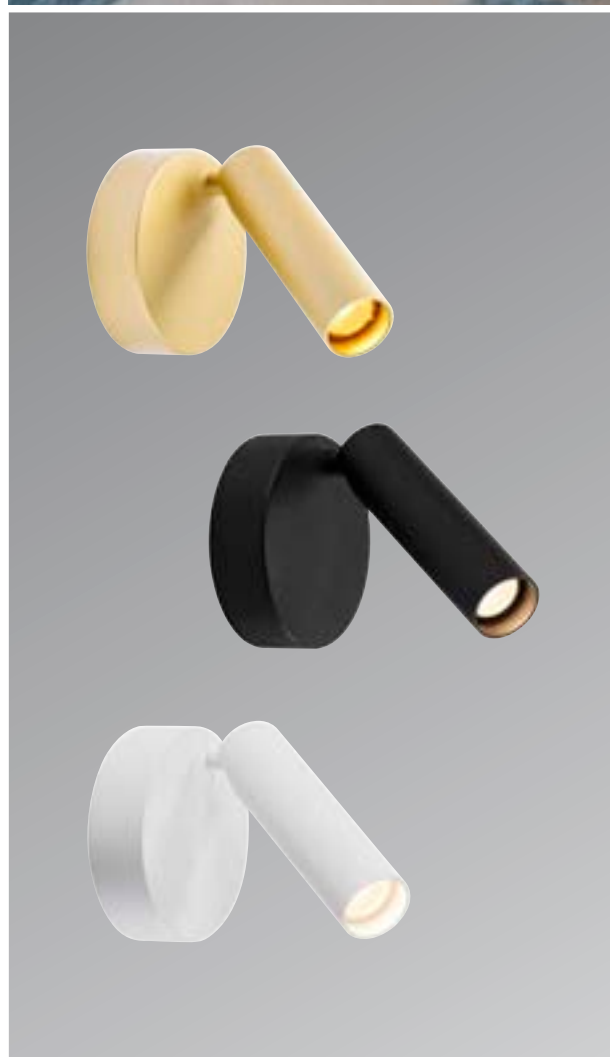
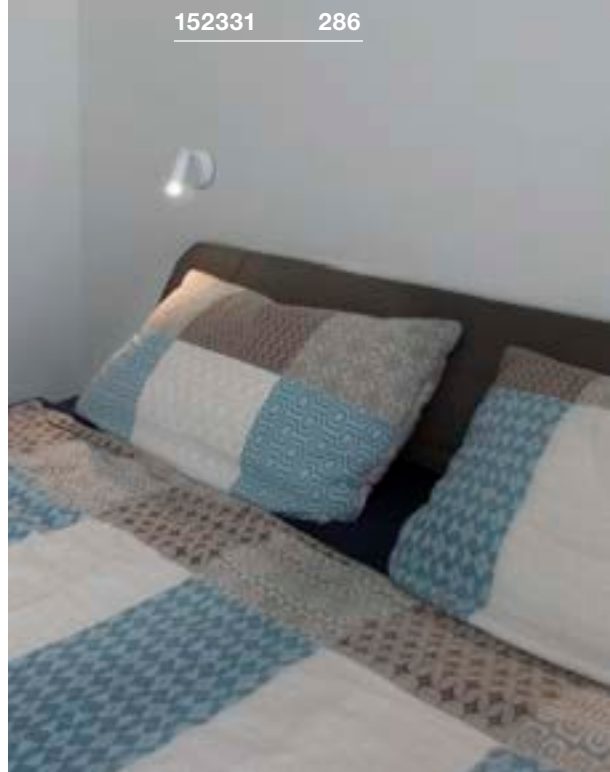



1000247 287

TOTHEE
CW, TRIAC

897

A-A++ Range A++-E

LED INSIDE



Product details

220-240V ~50/60Hz | 350mA
 Total consumption: 17W
 Material: Aluminium
 Dimmable: Triac C, Triac L

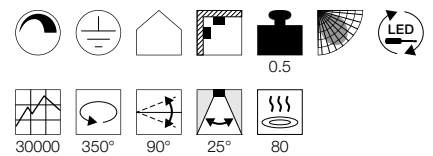

Dimensioned drawing

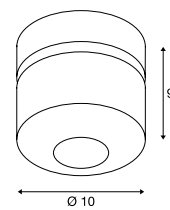

Variant	Item no.
1250lm 3000K CRI>80	
■ black	1000424
1250lm 3000K CRI>80	
■ white / black	1000425
1250lm 3000K CRI>80	
■ black	1000426
1250lm 3000K CRI>80	
■ white / black	1000427

BILAS
CW, single, TRIAC



A-A++ Range A++-E



• 240V LED

Product details

230V ~50/60Hz
Total consumption: 16W
Material: Aluminium / Glass
Dimmable: Triac C, Triac L

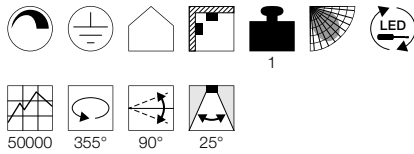

50000 355° 90° 25°

Dimensioned drawing

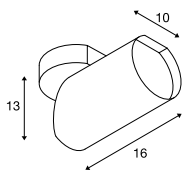

Variant	Item no.
1000lm 2700K CRI>80 ■ matt black	156420
1000lm 2700K CRI>80 □ matt white	156421

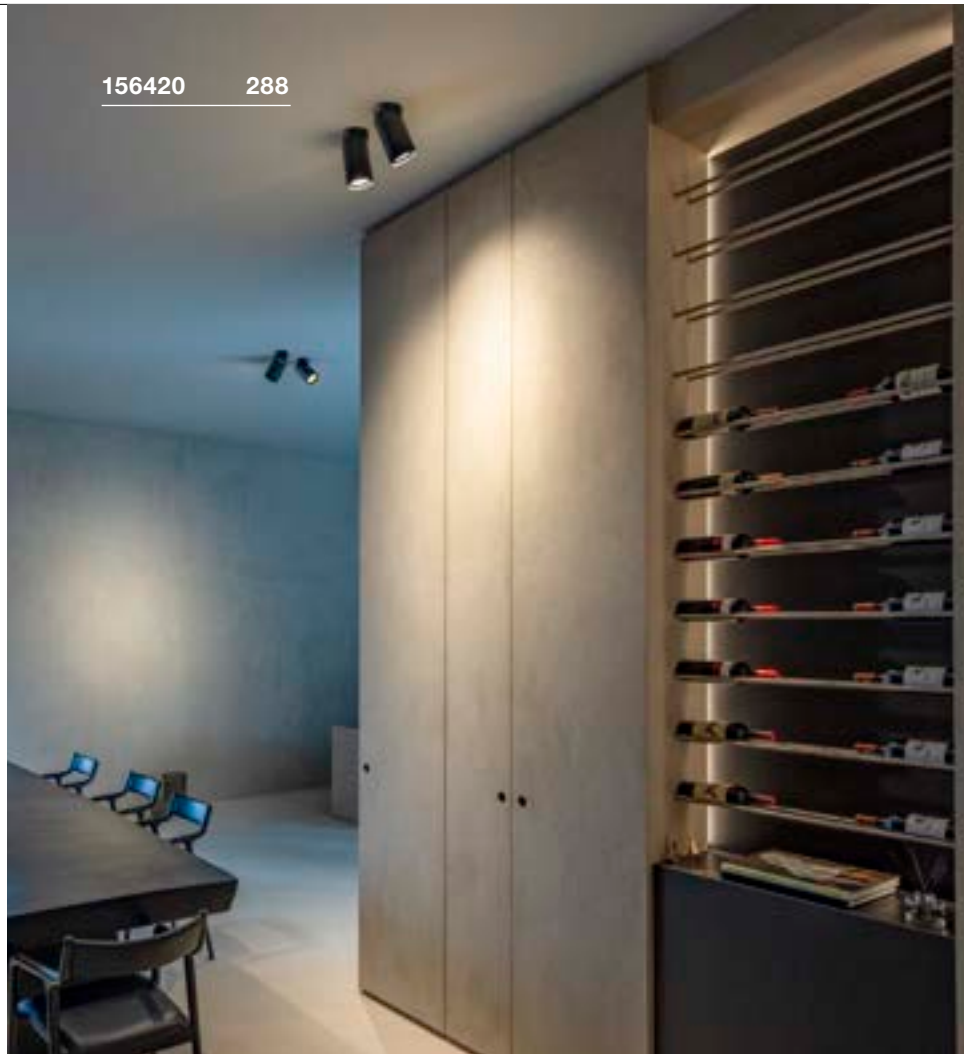

156420 288

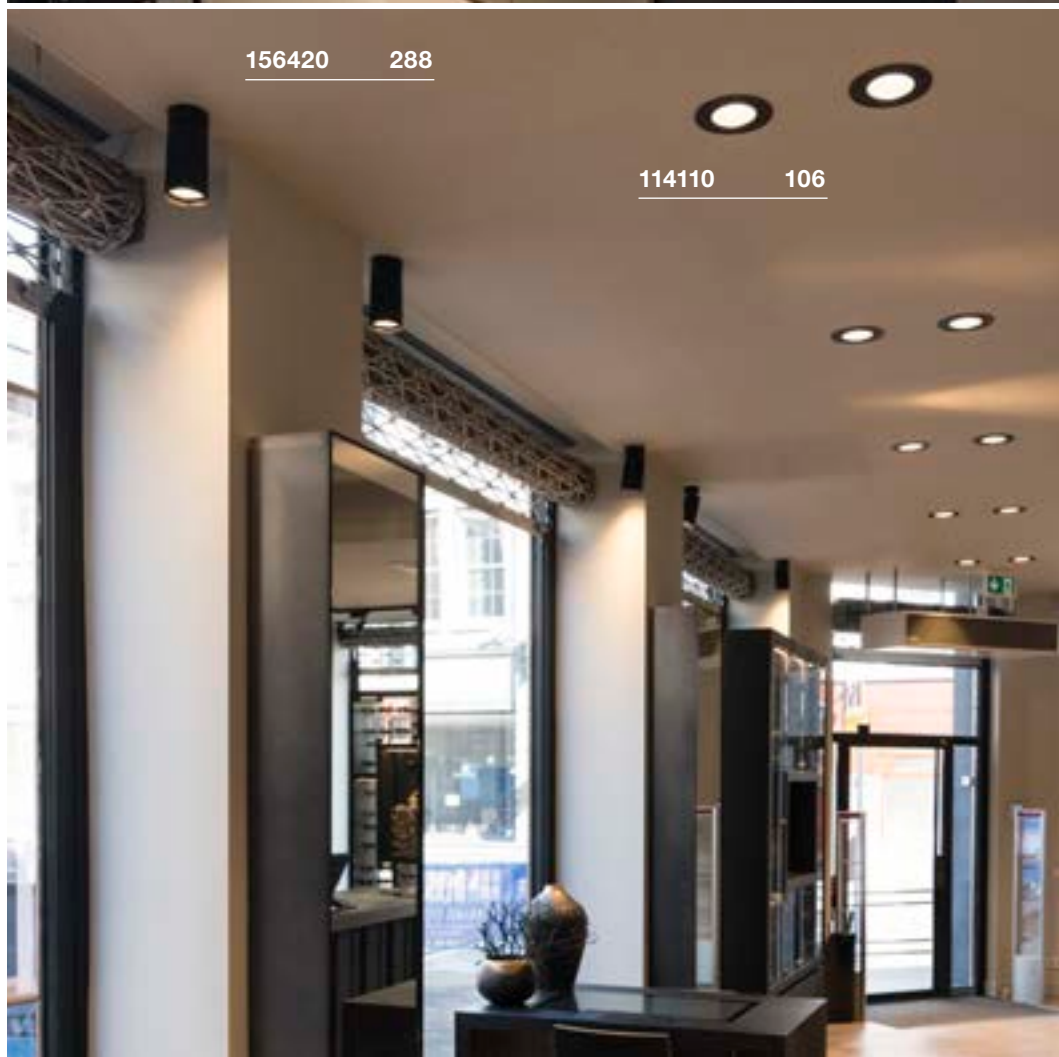

156420 288

114110 106

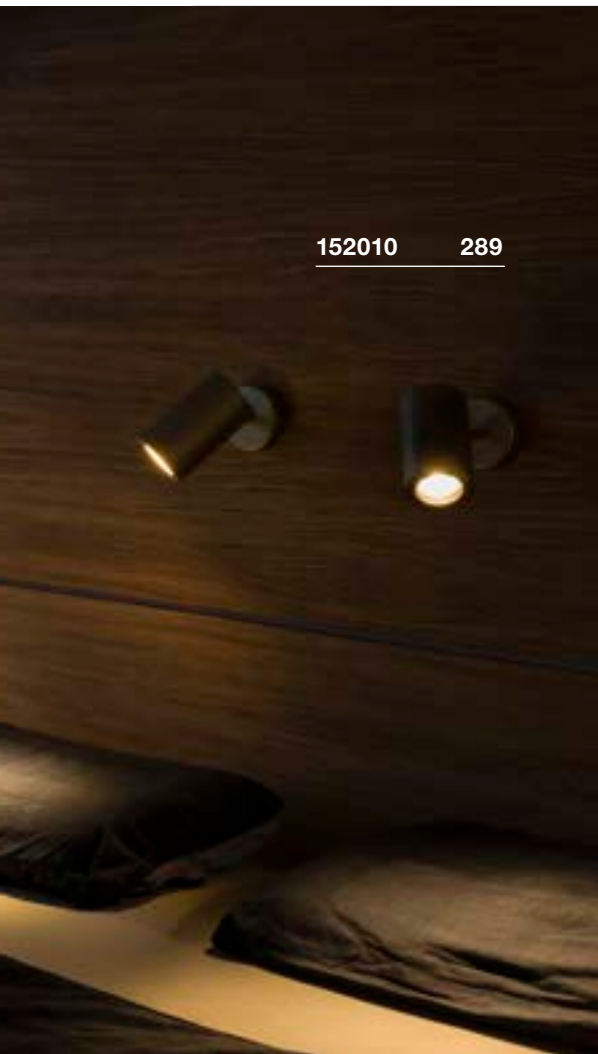

152010 289



152023 289

ENOLA B
CW, single, QPAR51



Product details

220-240V ~50/60Hz
Material: Aluminium / Steel

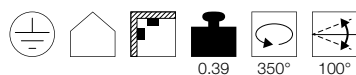

Dimensioned drawing

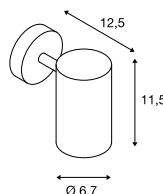

Note

Deco ring in lamp colour incl.
Optional black deco ring available as accessory.

Recommended accessories

■ Deco ring
Item no. 151840

Recommended lamp

LED GU10 7.2W 36°
4000K 540lm EEL=A+
8kWh/1000h
Item no. 1001565

LED GU10 7.2W 36°
2700K 520lm EEL=A+
8kWh/1000h
Item no. 1001560

Lamp details

max. 50W QPAR51
L: 6.7 cm max.

Variant	Item no.
GU10 QPAR51	
■ black	152010
□ white	152011
■ gold	152013

ENOLA B
CW, double, QPAR51



Product details

220-240V ~50/60Hz
Material: Aluminium / Steel

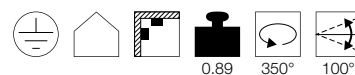

Dimensioned drawing

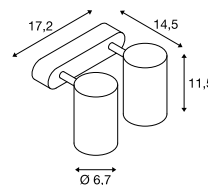

Note

Deco ring in lamp colour incl.
Optional black deco ring available as accessory.

Recommended accessories

■ Deco ring
Item no. 151840

Recommended lamp

GU10 5.5W 36°
2800K 420lm EEL=A+
6kWh/1000h
Item no. 1001217

LED GU10 5.5W 38°
2700K 400lm EEL=A+
6kWh/1000h
Item no. 1001030

Lamp details

2x max. 50W QPAR51
L: 6.7 cm max.

Variant	Item no.
GU10 QPAR51	
■ black	152020
□ white	152021
■ gold	152023

ENOLA B
CW, single, QPAR51



E-A++ Range A++-E



ENOLA B
CW, double, QPAR51



E-A++ Range A++-E



Product details

220-240V ~50/60Hz
Material: Aluminium / Steel

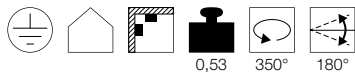

Product details

220-240V ~50/60Hz
Material: Aluminium / Steel

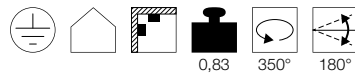

Dimensioned drawing

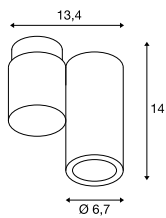

Dimensioned drawing

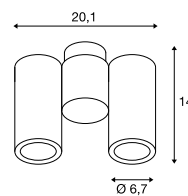

Note

Deco ring in lamp colour incl.
Optional black deco ring available as accessory.

Note

Deco ring in lamp colour incl.
Optional black deco ring available as accessory.

Recommended accessories

■ Deco ring
Item no. 151840



Recommended accessories

■ Deco ring
Item no. 151840



Recommended lamp

GU10 5.5W 38°
2800K 420lm EEL=A+
6kWh/1000h
Item no. 1001217



Recommended lamp

LED GU10 5.5W 38°
2700K 400lm EEL=A+
6kWh/1000h
Item no. 1001030



LED GU10 5.5W 38°
2700K 400lm EEL=A+
6kWh/1000h
Item no. 1001030



LED GU10 7.2W 36°
3000K 520lm EEL=A+
8kWh/1000h
Item no. 1001562



Lamp details

max. 50W QPAR51
L: 8 cm max.

Lamp details

2x max. 50W QPAR51
L: 8 cm max.

Variant	Item no.
GU10 QPAR51	
■ black	151820
GU10 QPAR51	
□ white	151821

Variant	Item no.
GU10 QPAR51	
■ black	151830
GU10 QPAR51	
□ white	151831

151821 290



151821 290





149070 291



149070 291

LIGHT EYE® 90
CW, single, QPAR51



E-A++ Range A++-E

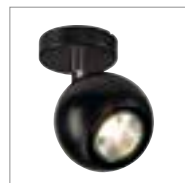

- The optional deco ring for the lamp in the appropriate colour reduces the distance between the housing and the lamp

Product details

220-240V ~50/60Hz
Material: Steel

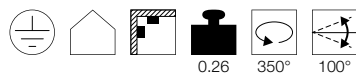

Dimensioned drawing

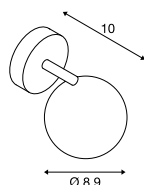

Recommended accessories

- Lamp deco ring diam. 5.7cm
Item no. 151040
- Lamp deco ring diam. 5.7cm
Item no. 151041
- Lamp deco ring diam. 5.7cm
Item no. 151049

Recommended lamp

- LED GU10 7.2W 36°
4000K 540lm EEL=A+
8kWh/1000h
Item no. 1001565
- LED GU10 7.2W 36°
2700K 520lm EEL=A+
8kWh/1000h
Item no. 1001560

Lamp details

max. 50W QPAR51

Variant	Item no.
GU10 QPAR51	
■ black / chrome	149060
GU10 QPAR51	
□ white / chrome	149061

LIGHT EYE® 90
CW, double, QPAR51



E-A++ Range A++-E

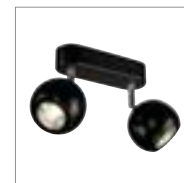

- The optional deco ring for the lamp in the appropriate colour reduces the distance between the housing and the lamp

Product details

220-240V ~50/60Hz
Material: Steel

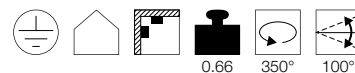

Dimensioned drawing

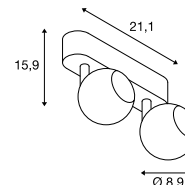

Recommended accessories

- Lamp deco ring diam. 5.7cm
Item no. 151040
- Lamp deco ring diam. 5.7cm
Item no. 151041
- Lamp deco ring diam. 5.7cm
Item no. 151049

Recommended lamp

- GU10 5.5W 36°
2800K 420lm EEL=A+
6kWh/1000h
Item no. 1001217
- LED GU10 5.5W 38°
2700K 400lm EEL=A+
6kWh/1000h
Item no. 1001030

Lamp details

2x max. 50W LED GU10 51mm

Variant	Item no.
GU10 LED GU10 51mm	
■ black / chrome	149070
GU10 LED GU10 51mm	
□ white / chrome	149071

HELIA
CW, single, TRIAC



A-A++ Range
A++-E



- Premium LED with CRI>90

Product details

220-240V ~50/60Hz | 500mA
Total consumption: 11W
Material: Aluminium
Dimmable: Triac C

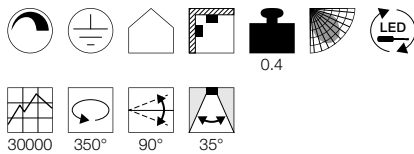

Dimensioned drawing

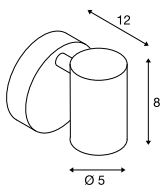

HELIA
CW, double, TRIAC



A-A++ Range
A++-E



- Premium LED with CRI>90

Product details

220-240V ~50/60Hz | 500mA
Total consumption: 18W
Material: Aluminium
Dimmable: Triac C, Triac L

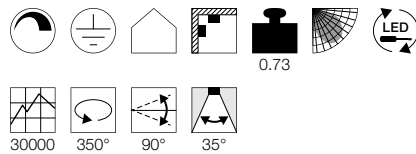

Dimensioned drawing

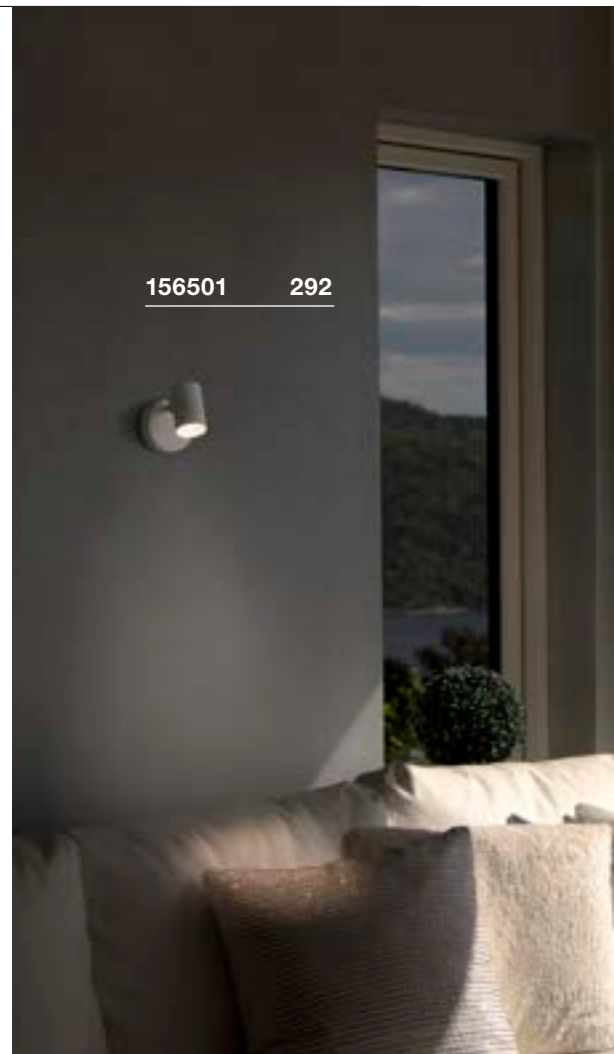
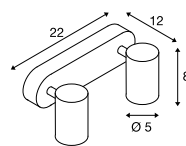

156501 292

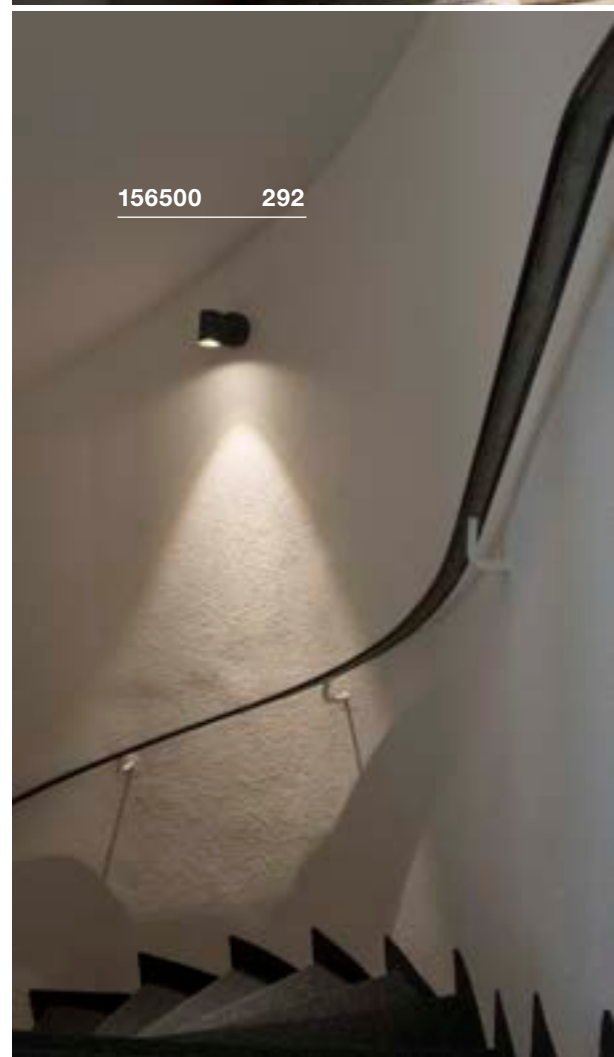

156500 292

Variant	Item no.
620lm 3000K CRI>90	
■ black	156500
620lm 3000K CRI>90	
□ white	156501

Variant	Item no.
1200lm 3000K CRI>90	
■ black	156510
1200lm 3000K CRI>90	
□ white	156511



156510 292

147412 294



ASTO TUBE
CW, QPAR51

E-A++ Range A++-E

- Use of long LED lamps possible

Product details

230V ~50Hz
Total consumption: 50W
Material: Aluminium



Recommended lamp

LED GU10 5.5W 38°
2700K 400lm EEL=A+
6kWh/1000h
Item no. 1001030



LED GU10 7.2W 36°
3000K 520lm EEL=A+
8kWh/1000h
Item no. 1001562



ASTO TUBE
CW, single, QPAR51



Dimensioned drawing

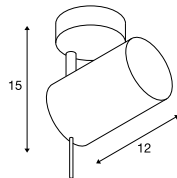

Lamp details

max. 50W QPAR51
Ø: 6.4 cm max. L: 8.1 cm max.

Variant	Item no.
GU10 QPAR51 0.34 kg □ white	147411

ASTO TUBE
CW, double, QPAR51

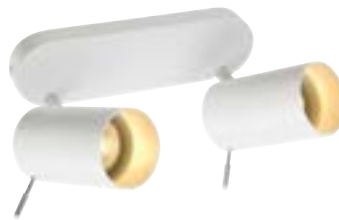

Dimensioned drawing

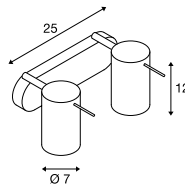

Lamp details

2x max. 50W QPAR51
Ø: 6.4 cm max. L: 8.1 cm max.

Variant	Item no.
GU10 QPAR51 0.7 kg □ white	147412

ASTO TUBE
CW, triple, QPAR51



Dimensioned drawing

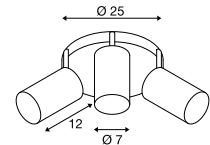

Lamp details

3x max. 50W QPAR51
Ø: 6.4 cm max. L: 8.1 cm max.

Variant	Item no.
GU10 QPAR51 1.15 kg □ white	147414

1002976 297



NOBLO
CW, TRIAC



A-A++ Range A++-E



- Rotating and swivelling lamp head

Product details

220-240V ~50/60Hz | 350mA

Material: Aluminium

Dimmable: Triac C, Triac L

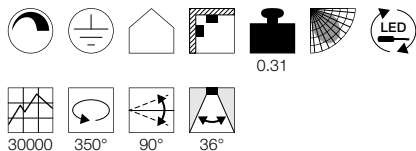

NOBLO
CW, single, TRIAC



NOBLO
CW, double, TRIAC



NOBLO
CW, triple, TRIAC



Variant	Item no.
600lm 2700K CRI>80 8W L: 9 cm W: 10.5 cm H: 12.7 cm 0.31 kg	
■ matt black	1002969
600lm 2700K CRI>80 8W L: 9 cm W: 10.5 cm H: 12.7 cm 0.31 kg	
□ matt white	1002970
600lm 2700K CRI>80 8W L: 9 cm W: 10.5 cm H: 12.7 cm 0.31 kg	
■ matt silver	1002971

Variant	Item no.
1200lm 2700K CRI>80 16W L: 24 cm W: 10.5 cm H: 12.7 cm 0.67 kg	
■ matt black	1002973
1200lm 2700K CRI>80 16W L: 24 cm W: 10.5 cm H: 12.7 cm 0.67 kg	
□ matt white	1002974
1200lm 2700K CRI>80 16W L: 24 cm W: 10.5 cm H: 12.7 cm 0.67 kg	
■ matt silver	1002975

Variant	Item no.
1800lm 2700K CRI>80 24W L: 40 cm W: 10.5 cm H: 12.7 cm 1 kg	
■ matt black	1002976
1800lm 2700K CRI>80 24W L: 40 cm W: 10.5 cm H: 12.7 cm 1 kg	
□ matt white	1002977
1800lm 2700K CRI>80 24W L: 40 cm W: 10.5 cm H: 12.7 cm 1 kg	
■ matt silver	1002978

1000889 299

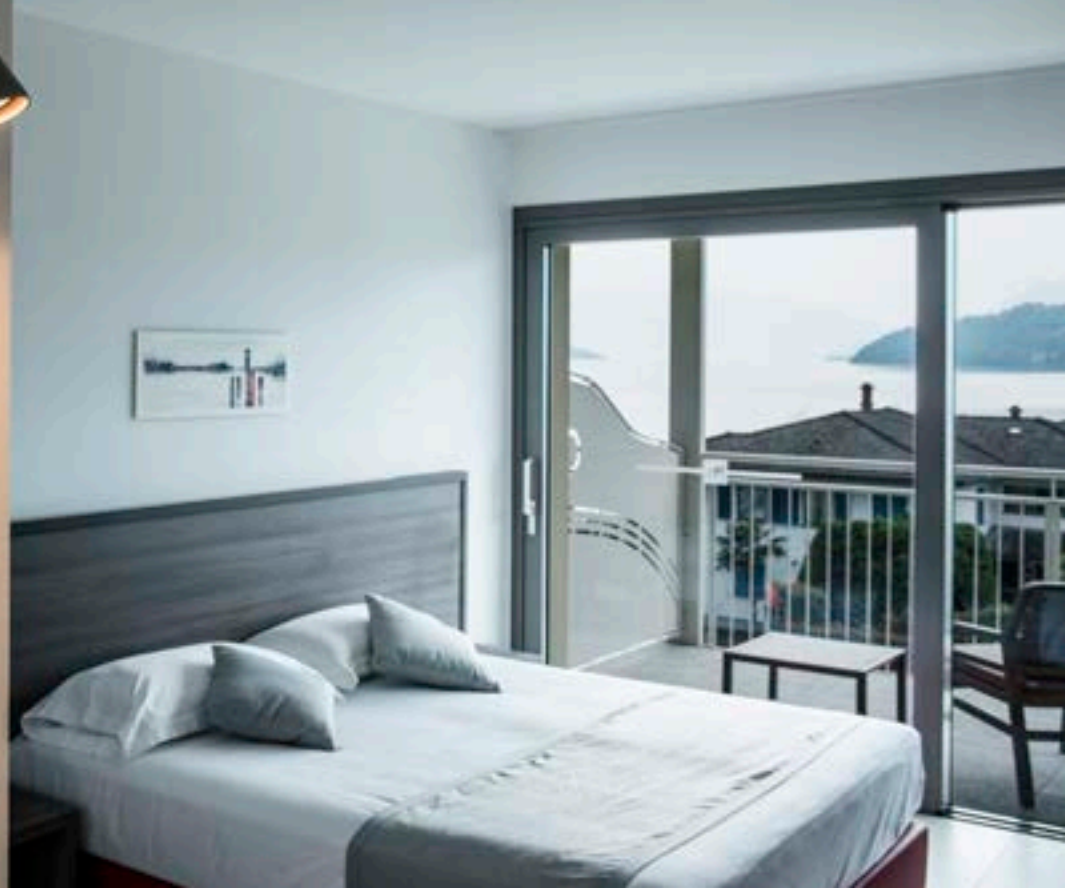

1000887 299



AVO
CW, QPAR51



E-A++ Range A++-E



Product details

230V ~50Hz
Material: Steel

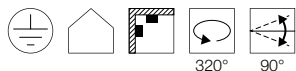

Recommended lamp

GU10 5.5W 36°
2800K 420lm EEL=A+
6kWh/1000h
Item no. 1001217



LED GU10 5.5W 38°
2700K 400lm EEL=A+
6kWh/1000h
Item no. 1001030



LED GU10 7.2W 36°
3000K 520lm EEL=A+
8kWh/1000h
Item no. 1001562



AVO
CW, single, QPAR51



Dimensioned drawing

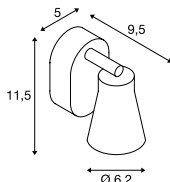

Lamp details

max. 50W QPAR51

Variant	Item no.
GU10 QPAR51 0.22 kg	
■ black	1000886
GU10 QPAR51 0.22 kg	
□ white	1000887
GU10 QPAR51 0.22 kg	
■ grey	1000888

AVO
CW, double, QPAR51



Dimensioned drawing

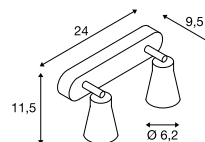

Lamp details

2x max. 50W QPAR51

Variant	Item no.
GU10 QPAR51 0.47 kg	
■ black	1000889
GU10 QPAR51 0.47 kg	
□ white	1000890
GU10 QPAR51 0.47 kg	
■ grey	1000891

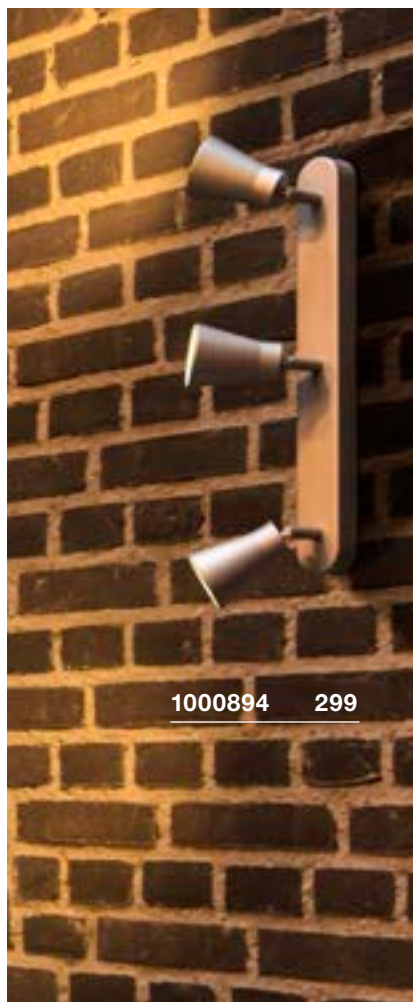

1000894 299

AVO
CW, triple, QPAR51



Dimensioned drawing

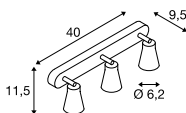

Lamp details

3x max. 50W QPAR51

Variant	Item no.
GU10 QPAR51 0.71 kg	
■ black	1000892
GU10 QPAR51 0.71 kg	
□ white	1000893
GU10 QPAR51 0.71 kg	
■ grey	1000894

AVO
CW, quad, QPAR51



Dimensioned drawing

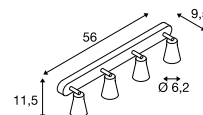

Lamp details

4x max. 50W QPAR51

Variant	Item no.
GU10 QPAR51 1 kg	
■ black	1000895
GU10 QPAR51 1 kg	
□ white	1000896
GU10 QPAR51 1 kg	
■ grey	1000897

147443 301



147316 304

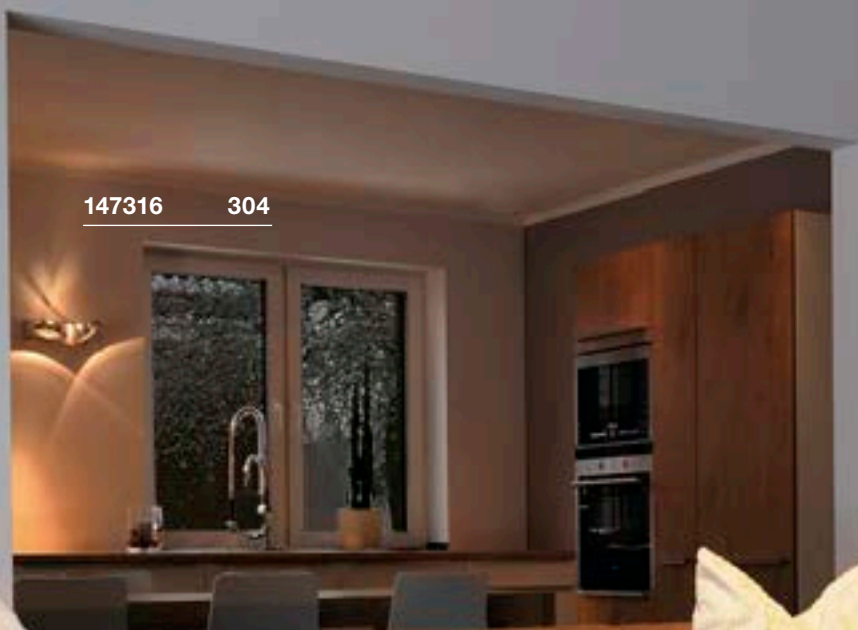

ASTO
QPAR51

E-A++ Range
A++-E



Product details

230V ~50Hz
Material: Aluminium

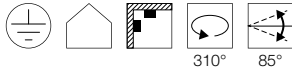

Recommended lamp

LED GU10 5.5W 38°
2700K 400lm EEL=A+
6kWh/1000h
Item no. 1001030



ASTO
CW, single, QPAR51



Dimensioned drawing

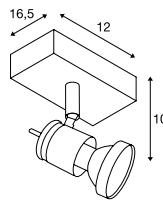

Lamp details

max. 50W QPAR51

Variant	Item no.
GU10 QPAR51 0.25 kg ■ matt aluminium	147441

ASTO
CW, double, QPAR51



Dimensioned drawing

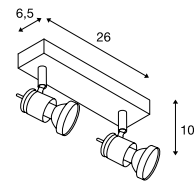

Lamp details

max. 75W QPAR51

Variant	Item no.
GU10 QPAR51 0.35 kg ■ matt aluminium	147442



ASTO
CW, triple, QPAR51



Dimensioned drawing

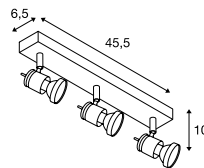

Lamp details

max. 75W QPAR51

Variant	Item no.
GU10 QPAR51 0.55 kg ■ matt aluminium	147443

ASTO
CW, quad, QPAR51



Dimensioned drawing

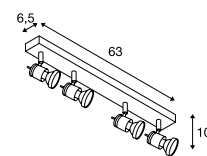

Lamp details

max. 75W QPAR51

Variant	Item no.
GU10 QPAR51 0.8 kg ■ matt aluminium	147444



147380 303



PURI
CW, QPAR51



E-A++ Range A++-E



Product details

230V ~50Hz
Material: Aluminium / Steel

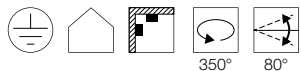

Recommended lamp

LED GU10 5.5W 38°
2700K 400lm EEL=A+
6kWh/1000h
Item no. 1001030



LED GU10 7.2W 36°
3000K 520lm EEL=A+
8kWh/1000h
Item no. 1001562



GU10 5.5W 36°
2800K 420lm EEL=A+
6kWh/1000h
Item no. 1001217



PURI
CW, single, QPAR51



Dimensioned drawing

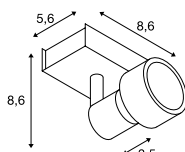

Lamp details

max. 50W QPAR51

Variant	Item no.
GU10 QPAR51 0.27 kg	
■ matt black	147360
GU10 QPAR51 0.27 kg	
□ matt white	147361

PURI
CW, triple, QPAR51



Dimensioned drawing

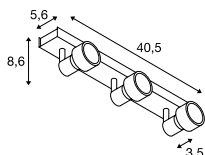

Lamp details

3x max. 50W QPAR51

Variant	Item no.
GU10 QPAR51 0.98 kg	
■ matt black	147380
GU10 QPAR51 0.98 kg	
□ matt white	147381

PURI
CW, double, QPAR51



Dimensioned drawing

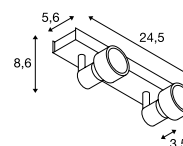

Lamp details

2x max. 50W QPAR51

Variant	Item no.
GU10 QPAR51 0.62 kg	
■ matt black	147370
GU10 QPAR51 0.62 kg	
□ matt white	147371

PURI
CW, quad, QPAR51



Dimensioned drawing

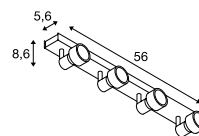

Lamp details

4x max. 50W QPAR51

Variant	Item no.
GU10 QPAR51 1.25 kg	
■ black	1002029
GU10 QPAR51 1.25 kg	
□ matt white	1002030



KALU
CW, QPAR111



E-A++ Range A++-E



KALU
CW, single, QPAR111



Dimensioned drawing

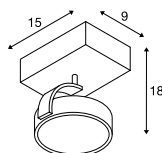

Lamp details

max. 75W QPAR111

Variant	Item no.
GU10 QPAR111 0.44 kg	
■ black	1000702
GU10 QPAR111 0.44 kg	
□ matt white	147301
GU10 QPAR111 0.44 kg	
■ matt aluminium	147306

KALU
CW, double, QPAR111



Dimensioned drawing

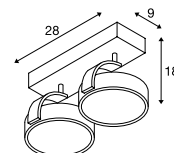

Lamp details

2x max. 75W QPAR111

Variant	Item no.
GU10 QPAR111 0.8 kg	
■ black	1000703
GU10 QPAR111 0.8 kg	
□ matt white	147311
GU10 QPAR111 0.8 kg	
■ matt aluminium	147316

Product details

220-240V ~50/60Hz
Material: Aluminium

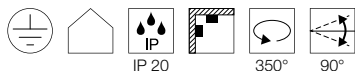

Recommended lamp

LED GU10 13W 30°
2700K 1100lm EEL=A+
13kWh/1000h
Item no. 1001242



LED GU10 9W 25°
2700-6500K 765lm EEL=A+
9kWh/1000h
Item no. 1001920



LED GU10 10W 38°
2700K 540lm EEL=A+
10kWh/1000h
Item no. 1001028



LED GU10 13W 140°
2700K 1000lm EEL=A+
13kWh/1000h
Item no. 1001244



KALU
CW, triple, QPAR111



Dimensioned drawing

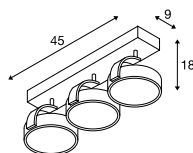

Lamp details

3x max. 75W QPAR111

Variant	Item no.
GU10 QPAR111 1.23 kg	
■ black	1000704
GU10 QPAR111 1.23 kg	
□ matt white	147321
GU10 QPAR111 1.23 kg	
■ matt aluminium	147326

KALU
CW, quad, QPAR111



Dimensioned drawing

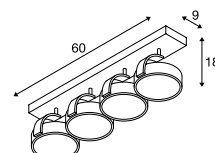

Lamp details

4x max. 75W QPAR111

Variant	Item no.
GU10 QPAR111 1.7 kg	
■ black	1002023
GU10 QPAR111 1.7 kg	
□ white	1002024
GU10 QPAR111 1.7 kg	
■ matt aluminium	1002025

KALU CW QPAR111
replaces
KALU CW QR111

Compare here and
discover new advantages

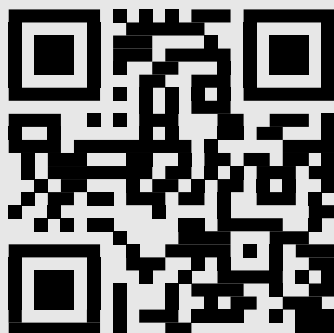

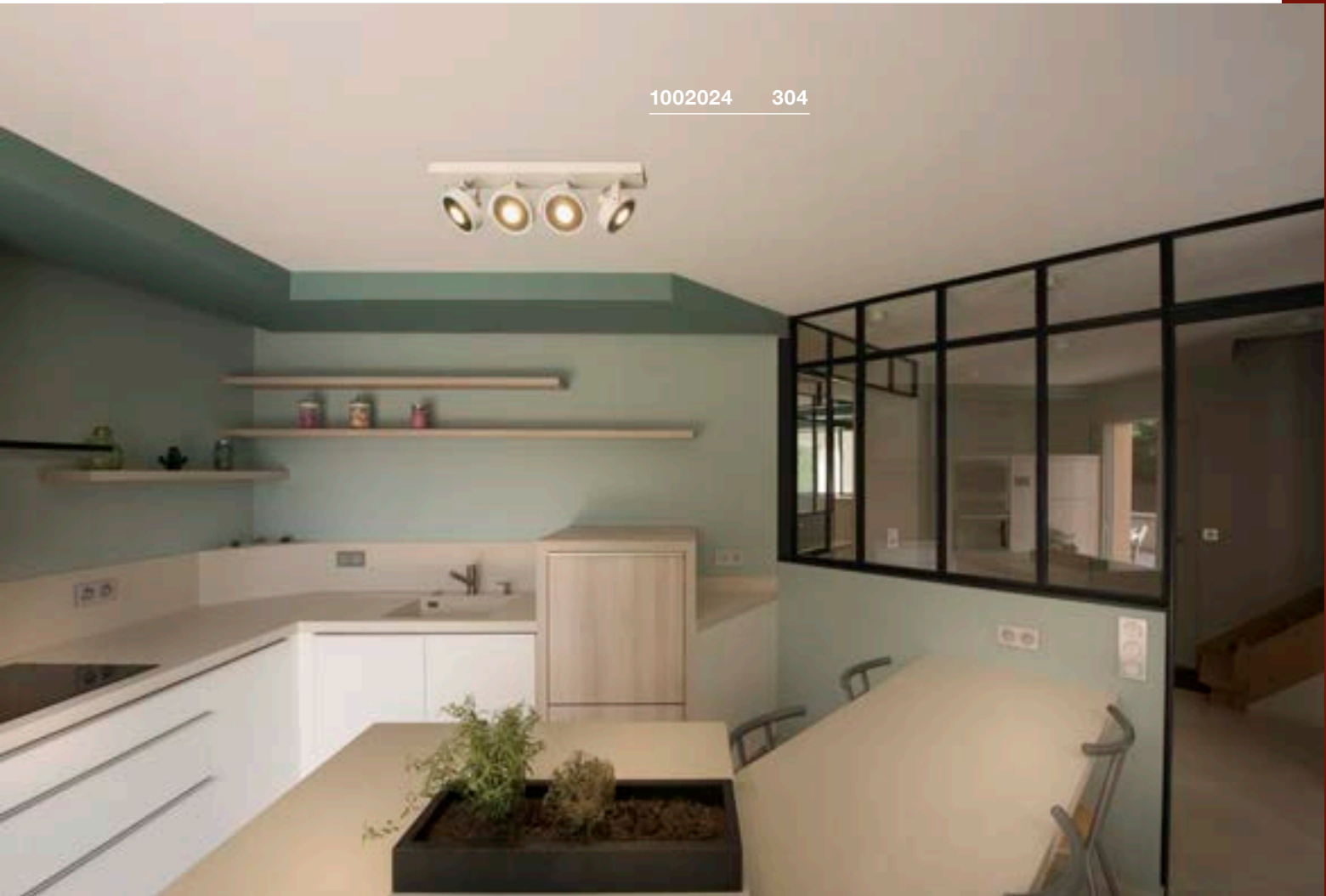

1002024 304



1000702 304

KALU
CW, TRIAC



A-A++ Range A++-E



- Luminaire unit, can be rotated by 340° and swivelled by 120°

Product details

220-240V ~50/60Hz | 350mA
Material: Aluminium / Polycarbonate (PC)
Dimmable: Triac C

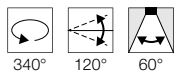
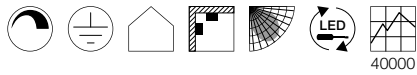

KALU
CW, single, TRIAC



Dimensioned drawing

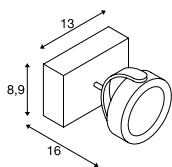

Variant	Item no.
1000lm 3000K CRI>80 17W 0.77 kg ■ black	1000127
1000lm 3000K CRI>80 17W 0.77 kg ■ white / black	1000128

KALU
CW, double, TRIAC



Dimensioned drawing

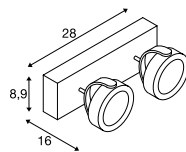

Variant	Item no.
2000lm 3000K CRI>80 31W 1.6 kg ■ black	1000129
2000lm 3000K CRI>80 31W 1.6 kg ■ white / black	1000130

KALU
CW, triple, TRIAC



Dimensioned drawing

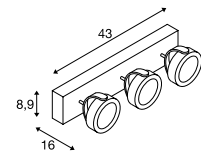

Variant	Item no.
3000lm 3000K CRI>80 47W 2.2 kg ■ black	1000131
3000lm 3000K CRI>80 47W 2.2 kg ■ white / black	1000132



KALU
CW, quad, TRIAC



A-A++ Range A++-E



- Luminaire unit, rotates by 340° and swivels by 120°
- Premium LED

Product details

220-240V ~50/60Hz | 700mA
Total consumption: 60W
Material: Aluminium / Polycarbonate (PC)
Dimmable: Triac C

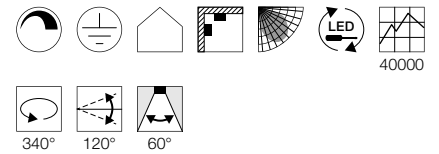

KALU
CW, quad, long, TRIAC



Dimensioned drawing

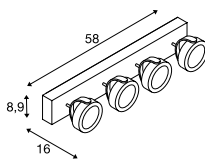

Variant	Item no.
4000lm 3000K CRI>80 2.9 kg	
■ black	1000133
4000lm 3000K CRI>80 2.9 kg	
■ white / black	1000134

KALU
CW, quad, square, TRIAC



Dimensioned drawing

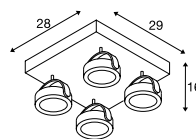

Variant	Item no.
4000lm 3000K CRI>80 3.75 kg	
■ black	1000135
4000lm 3000K CRI>80 3.75 kg	
■ white / black	1000136

KALU
CW, quad, wide, TRIAC





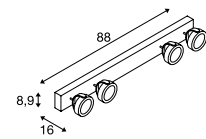



Dimensioned drawing











Variant	Item no.
4000lm 3000K CRI>80 3.65 kg	
■ black	1000137
4000lm 3000K CRI>80 3.65 kg	
■ white / black	1000138







LIPSY® LIGHT SERIES.

THE COLOUR OF YOUR CHOICE.

	LIPSY® 30 VALETO®	LIPSY® 40 VALETO®	LIPSY® 50 VALETO®
Example			
Lamp			
Sensor	-	-	-
Size	Ø: 28 cm	Ø: 39 cm	Ø: 49.6 cm
Colour temperature	3000K	3000K	3000K
Light colour	1400lm	1700lm	2800lm
Control dimmable	Can be remote controlled and dimmed using SLV VALETO® CCT/RGBW remote control [1002994] or Gateway [1002411]	Can be remote controlled and dimmed using SLV VALETO® CCT/RGBW remote control [1002994] or Gateway [1002411]	Can be remote controlled and dimmed using SLV VALETO® CCT/RGBW remote control [1002994] or Gateway [1002411]

	LIPSY® 30 Dome	LIPSY® 40 Dome	LIPSY® 50 Dome	
Example				
Lamp				
Sensor	-	-	-	
Size	Ø: 30 cm	Ø: 35 cm	Ø: 40 cm	
Colour temperature	3000K 4000K	3000K 4000K	3000K 4000K	
Light colour	1400/1600lm	1800/2000lm	2200/2400lm	 <p>With this LIPSY® variant you can select/switch the colour temperature!</p>
Control dimmable	-	-	-	

	LIPSY® 30 Drum	LIPSY® 40 Drum	LIPSY® 50 Drum	
Example				  With this LIPSY® variant you can select/switch the colour temperature!
Lamp				
Sensor	-	-	-	
Size	Ø: 30 cm	Ø: 35 cm	Ø: 40 cm	
Colour temperature	3000K 4000K	3000K 4000K	3000K 4000K	
Light colour	1400/1600lm	1800/2000lm	2200/2400lm	
Control dimmable	-	-	-	

	LIPSY® 40 CW, Drum	LIPSY® 50 CW, Drum	
Example			  With this LIPSY® variant you can select the colour temperature!
Lamp			
Sensor	-	-	
Size	Ø: 35 cm	Ø: 40 cm	
Colour temperature	3000K 4000K	3000K 4000K	
Light colour	1800/2000lm	2200/2400lm	
Control dimmable	-	-	

LIPSY®
CW, VALETO®

- Can be integrated into the VALETO® system

Product details

230V ~50/60Hz
Total consumption: 14,5W/17W/31,5W
Material: Polymethylacrylate (PMMA) / Steel

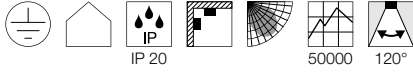

Note

Can be remote controlled and dimmed using SLV VALETO® CCT/RGBW remote control [1002994] or Gateway [1002411]

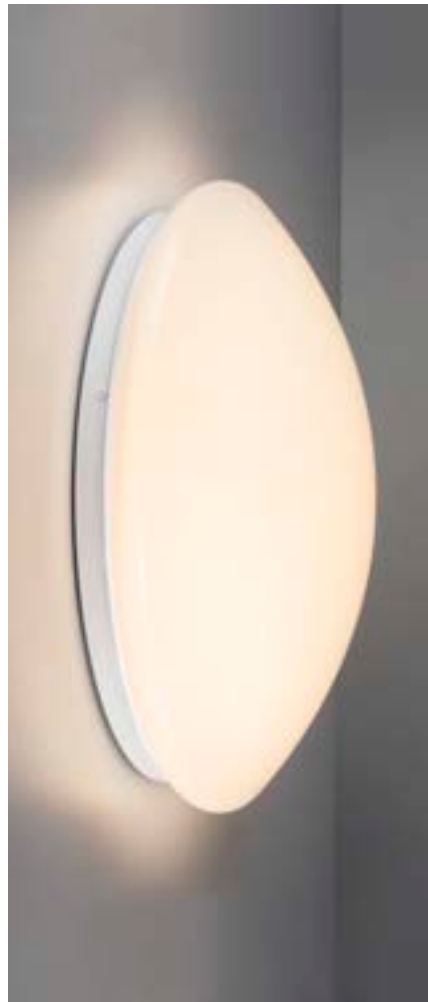

1002133 310

LIPSY® 30
CW, VALETO®



Dimensioned drawing

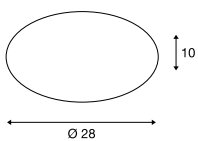

Variant	Item no.
1400lm 3000K CRI>80 0.4 kg □ white	1002132

LIPSY® 40
CW, VALETO®



Dimensioned drawing

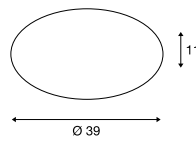

Variant	Item no.
1700lm 3000K CRI>80 0.77 kg □ white	1002133

LIPSY® 50
CW, VALETO®



Dimensioned drawing

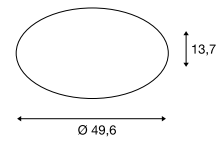

Variant	Item no.
2800lm 3000K CRI>80 1.36 kg □ white	1002134

LIPSY®
CW, Dome

A-A++ Range
A++-E

- Colour temperature (3000K/4000K) selectable using a switch

Product details

220-240V ~50/60Hz | 500mA
Total consumption: 15W/18W/21W
Material: Aluminium / Polycarbonate (PC)

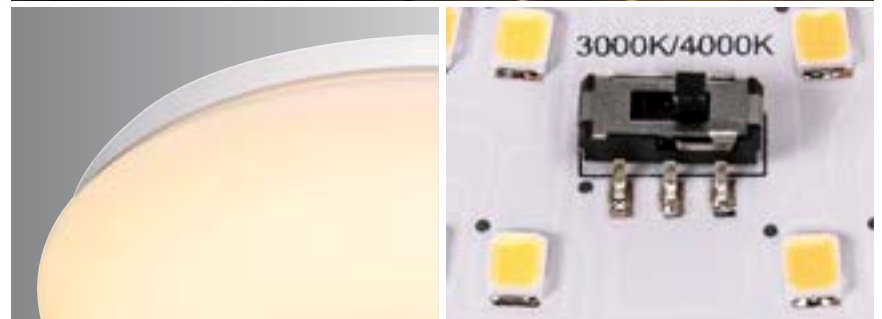
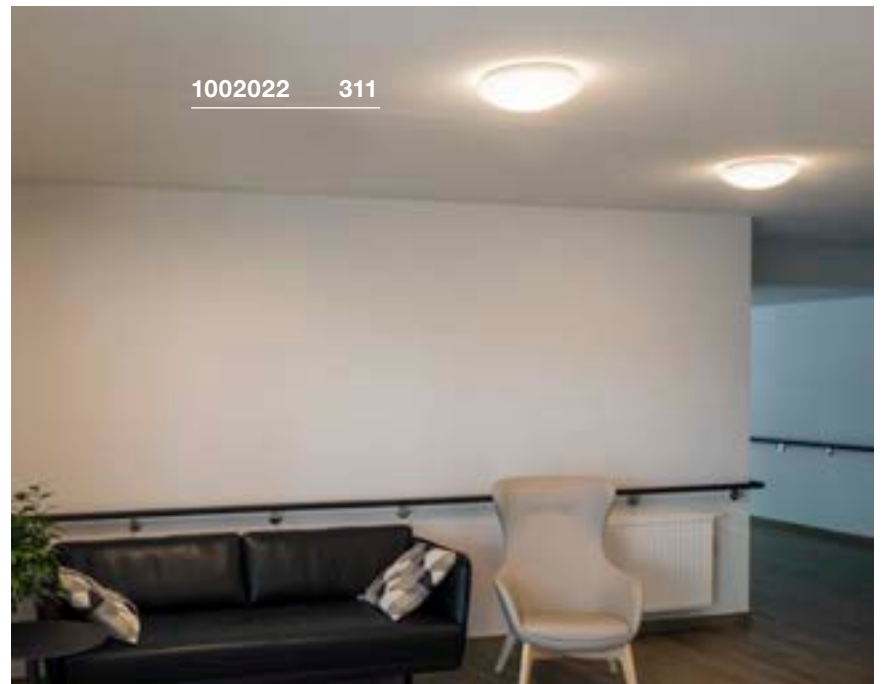
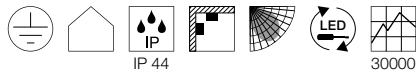

LIPSY® 30
CW, Dome



Dimensioned drawing

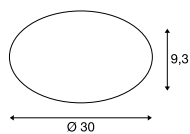

Variant	Item no.
1400/1600lm 3000/4000K CRI>80 0.6 kg	1002020
□ white	

LIPSY® 40
CW, Dome



Dimensioned drawing

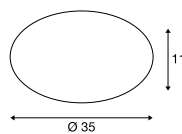

Variant	Item no.
1800/2000lm 3000/4000K CRI>80 0.77 kg	1002021
□ white	

LIPSY® 50
CW, Dome



Dimensioned drawing

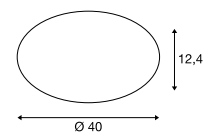

Variant	Item no.
2200/2400lm 3000/4000K CRI>80 0.96 kg	1002022
□ white	

LIPSY®
CW, Drum

A-A++ Range
A++-E

- Colour temperature (3000K/4000K) selectable using a switch

Product details

220-240V ~50/60Hz | 500mA
Total consumption: 15W/18W/21W
Material: Aluminium / Polycarbonate (PC)

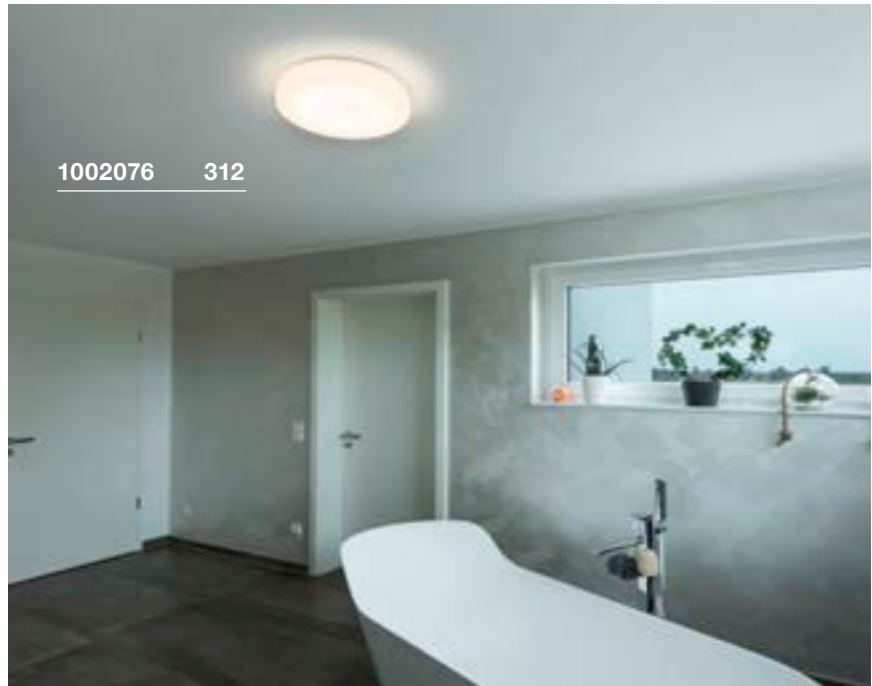
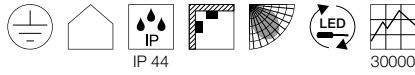

LIPSY® 30
CW, Drum



Dimensioned drawing

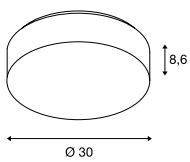

LIPSY® 40
CW, Drum



Dimensioned drawing

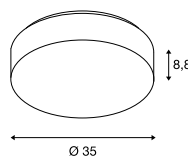

LIPSY® 50
CW, Drum



Dimensioned drawing

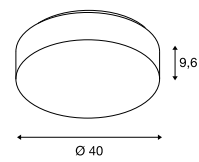

Variant	Item no.
1400/1600lm 3000/4000K CRI>80 0.6 kg □ white	1002075

Variant	Item no.
1800/2000lm 3000/4000K CRI>80 0.77 kg □ white	1002076

Variant	Item no.
2200/2400lm 3000/4000K CRI>80 0.96 kg □ white	1002077

LIPSY®
CW, Drum, DALI

A-A++ Range A++-E

- Switchable light colour

Product details

220-240V ~50/60Hz | 500mA
Total consumption: 18W/21W
Material: Aluminium / Polycarbonate (PC)
Dimmable: Dali

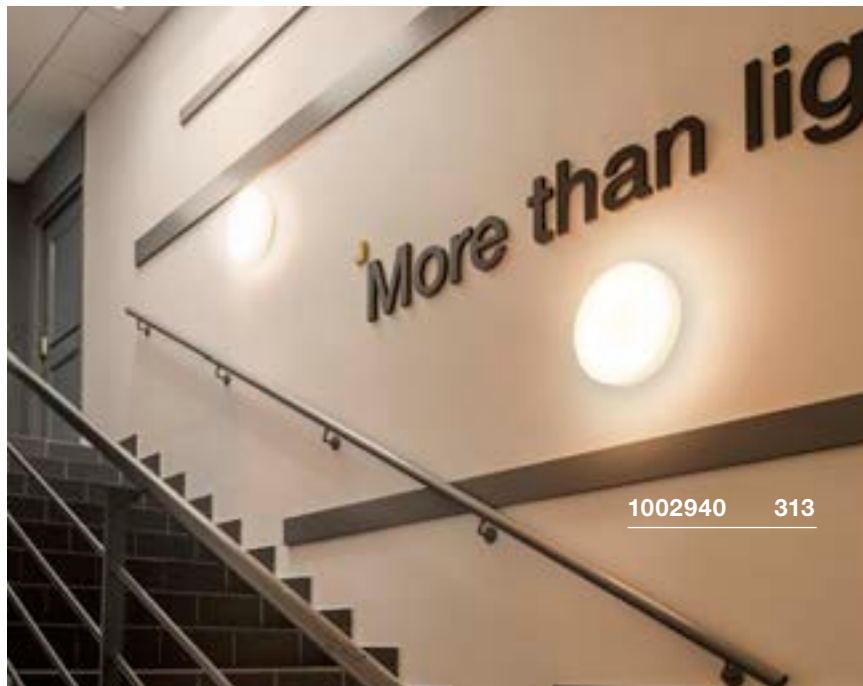
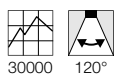

LIPSY® 40
CW, Drum, DALI



Dimensioned drawing

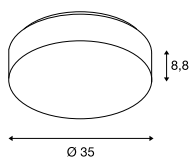

Variant	Item no.
1800/2000lm 3000/4000K CRI>80 0.77 kg □ white	1002940

LIPSY® 50
CW, Drum, DALI



Dimensioned drawing

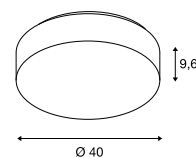

Variant	Item no.
2200/2400lm 3000/4000K CRI>80 0.96 kg □ white	1002941

MARONA
CW, TRIAC

A-A++ Range
A++-E



155156 314



Product details

200-240V ~50/60Hz | 430mA
Total consumption: 15W
Material: Polymethylacrylate (PMMA) / Steel
Dimmable: Triac C, Triac L

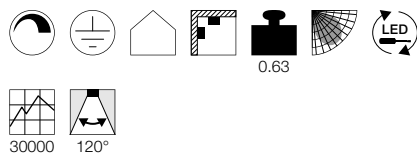

Dimensioned drawing

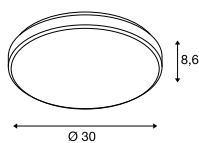

Variant	Item no.
1200lm 3000K CRI>80 ■ chrome	155152
1200lm 3000K CRI>80 ■ matt grey	155156



MOLDI 32
CW

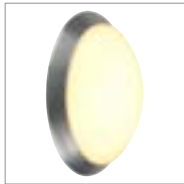

- Premium LED

Product details

100-240V ~50/60Hz | 450mA
Total consumption: 22W
Material: Aluminium / Plastic PC



Dimensioned drawing

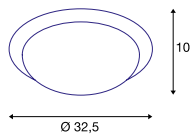

MOLDI 46
CW



- Premium LED

Product details

100-240V ~50/60Hz | 700mA
Total consumption: 34W
Material: Aluminium / Plastic PC



Dimensioned drawing

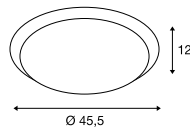

MOLDI 46
CW, Sensor

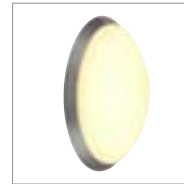
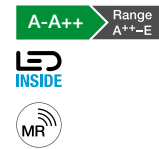

- Premium LED
- With integrated MR (microwave sensor)

Product details

100-240V ~50/60Hz | 700mA
Total consumption: 34W
Material: Aluminium / Plastic PC



Dimensioned drawing

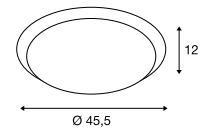

Variant	Item no.
1150lm 3000K CRI>80 ■ matt aluminium	134323

Variant	Item no.
2010lm 3000K CRI>80 ■ matt aluminium	134333

Variant	Item no.
2010lm 3000K CRI>80 ■ matt aluminium	134343

MELAN
CW, E27



Product details

230V ~50Hz
Material: Aluminium / Glass

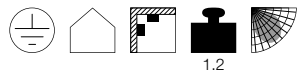

Dimensioned drawing

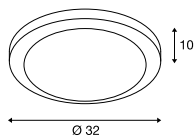

Recommended lamp

LED E27 7W 280°
2200-2700K 830lm EEL=A++
7kWh/1000h
Item no. 1002126



LED E27 9,1W 240°
2700K 760lm EEK=A+
10kWh/1000h
Item no. 560402



Lamp details

max. 60W
Ø: 7 cm max. L: 16 cm max.

Variant	Item no.
E27	
□ matt aluminium	155236





155180 317

GLASSA
CW, square, E27

E-A++ Range A++-E



Product details

230V ~50Hz
Material: Frosted glass / Steel

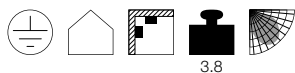

Dimensioned drawing

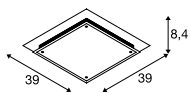

Recommended lamp

LED E27 7W 280°
2700K 790lm EEL=A++
7kWh/1000h
Item no. 1002124



LED E27 8.5W
2700K 806lm EEL=A+
10kWh/1000h
Item no. 560161



Lamp details

2x max. 60W
Ø: 4.8 cm max. L: 14.8 cm max.

Variant	Item no.
E27	
■ matt transparent / chrome	155180

GLASSA
CW, round, E27

E-A++ Range A++-E

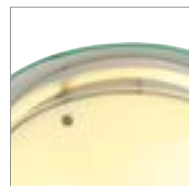
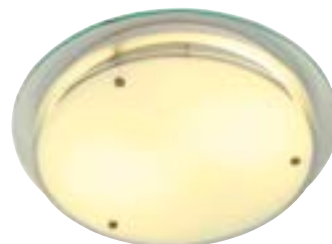

Product details

230V ~50Hz
Material: Steel / Glass

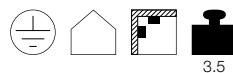

Dimensioned drawing

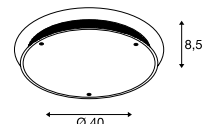

Recommended lamp

LED E27 7W 280°
2700K 790lm EEL=A++
7kWh/1000h
Item no. 1002124



LED E27 8.5W
2700K 806lm EEL=A+
10kWh/1000h
Item no. 560161



Lamp details

2x max. 60W
Ø: 4.8 cm max. L: 13.6 cm max.

Variant	Item no.
E27	
■ matt transparent / chrome	155185

SIMA
CW, round, TRIAC

A-A++ Range
A++-E



- Flat, robust design
- With spacer for cable on-wall mounting

Product details

220-240V ~50/60Hz | 350mA
Total consumption: 25W
Material: Polycarbonate (PC)
Dimmable: Triac C, Triac L

Dimensioned drawing

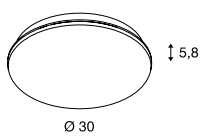

163020 318

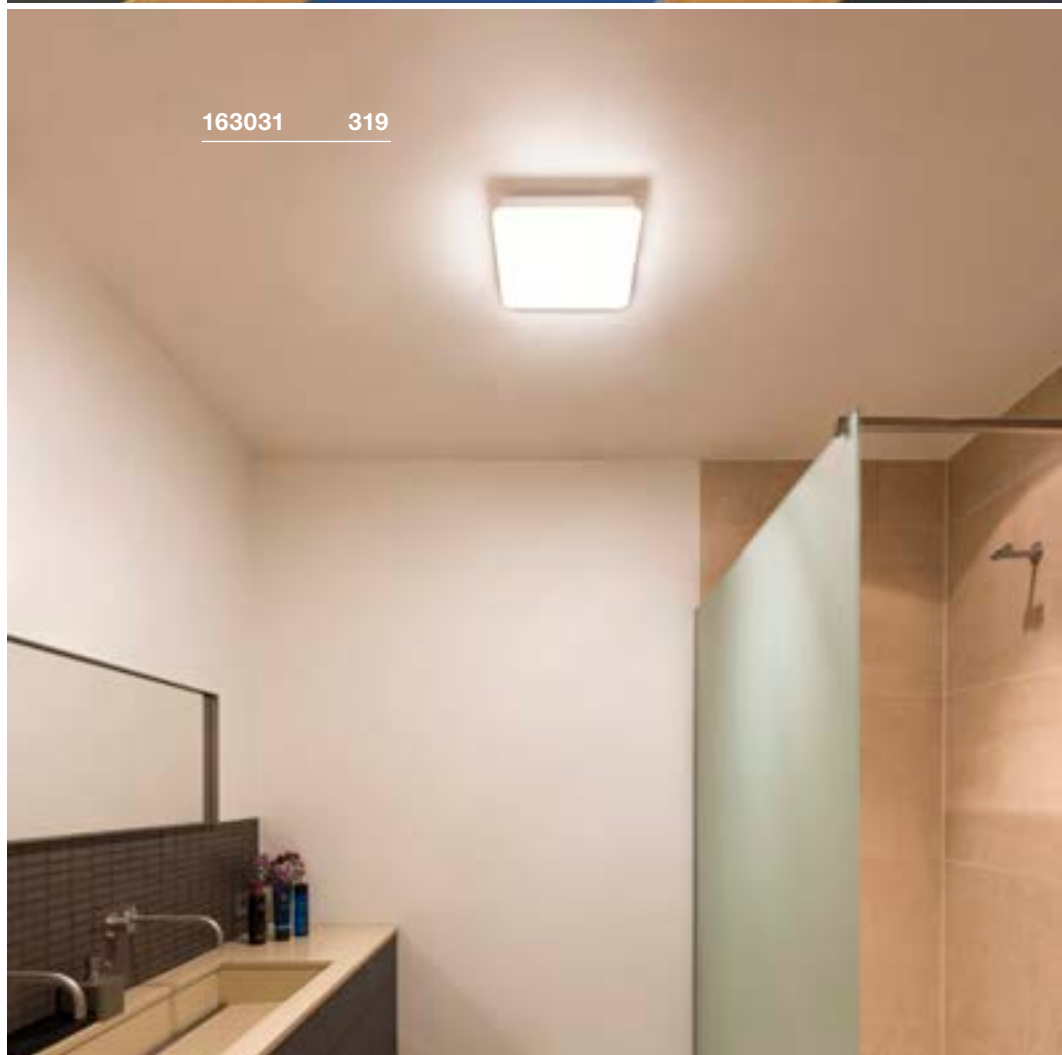

163031 319

Variant	Item no.
2300lm 3000K CRI>80 □ white	163020

SIMA
CW, round, Sensor

A-A++ Range A++-E



- Flat, robust design
- With spacer for cable on-wall mounting
- Motion sensor with MR (micro-wave) technology integrated in the luminaire housing

Product details

220-240V ~50/60Hz | 350mA
Total consumption: 27W
Material: Polycarbonate (PC)

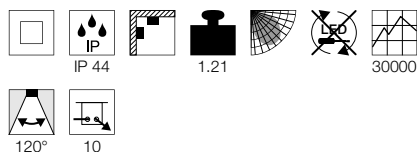

Dimensioned drawing

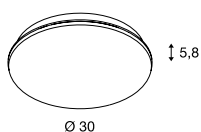

SIMA
CW, square, TRIAC

A-A++ Range A++-E



- Flat, robust design
- With spacer for cable on-wall mounting

Product details

220-240V ~50/60Hz | 350mA
Total consumption: 25W
Material: Polycarbonate (PC)
Dimmable: Triac C, Triac L

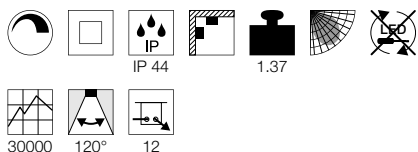

Dimensioned drawing

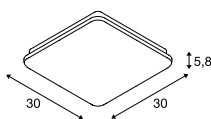

SIMA
CW, square, Sensor

A-A++ Range A++-E



- Flat, robust design
- With spacer for cable on-wall mounting
- Motion sensor with MR (micro-wave) technology integrated in the luminaire housing

Product details

220-240V ~50/60Hz | 350mA
Total consumption: 27W
Material: Polycarbonate (PC)

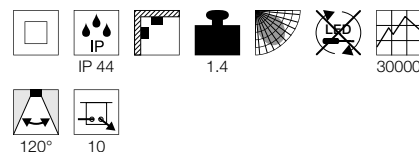

Dimensioned drawing

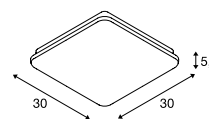

Variant	Item no.
2300lm 3000K CRI>80 □ white	163021

Variant	Item no.
2300lm 3000K CRI>80 □ white	163030

Variant	Item no.
2300lm 3000K CRI>80 □ white	163031

1001884 321



MEDO 30 CORONA
CW, TRIAC



A-A++ Range A++-E

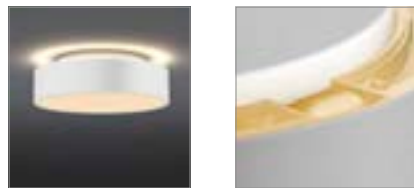

- With corona effect
- Colour temperature (3000K/4000K) selectable using a switch

Product details

220-240V ~50/60Hz | 350mA
Total consumption: 15W
Material: Aluminium / Polycarbonate (PC)
Dimmable: Triac C

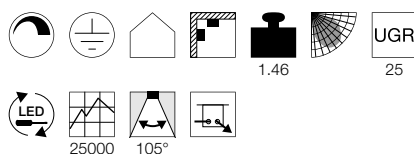

Dimensioned drawing

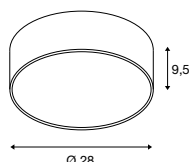

Note

Suspension set excl.

Recommended accessories

- Suspension set 1.5m
Item no. 135250
- Suspension set 1.5m
Item no. 135251
- Suspension set 1.5m
Item no. 135254
- Suspension set 5m
Item no. 1001950
- Suspension set 5m
Item no. 1001951
- Suspension set 5m
Item no. 1001952

Variant	Item no.
Down: 1230/1280lm 3000/4000K CRI>80 Up: 20lm 3000/4000K CRI>80	
■ black	1001877
Down: 1230/1280lm 3000/4000K CRI>80 Up: 20lm 3000/4000K CRI>80	
□ white	1001881
Down: 1230/1280lm 3000/4000K CRI>80 Up: 20lm 3000/4000K CRI>80	
■ grey	1001882

MEDO 40 CORONA
CW, TRIAC



A-A++ Range A++-E

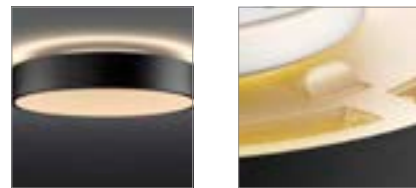

- With corona effect
- Colour temperature (3000K/4000K) selectable using a switch

Product details

220-240V ~50/60Hz | 700mA
Total consumption: 30W
Material: Aluminium / Polycarbonate (PC)
Dimmable: Triac C

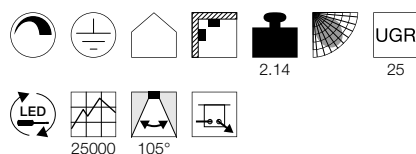

Dimensioned drawing

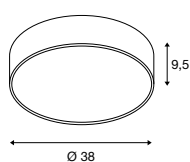

Note

Suspension set excl.

Recommended accessories

- Suspension set 1.5m
Item no. 135250
- Suspension set 1.5m
Item no. 135251
- Suspension set 1.5m
Item no. 135254
- Suspension set 5m
Item no. 1001950
- Suspension set 5m
Item no. 1001951
- Suspension set 5m
Item no. 1001952

Variant	Item no.
Down: 2750/2900lm 3000/4000K CRI>80 Up: 50lm 3000/4000K CRI>80	
■ black	1001883
Down: 2750/2900lm 3000/4000K CRI>80 Up: 50lm 3000/4000K CRI>80	
□ white	1001884
Down: 2750/2900lm 3000/4000K CRI>80 Up: 50lm 3000/4000K CRI>80	
■ grey	1001885

MEDO 60 CORONA
CW, TRIAC



A-A++ Range A++-E

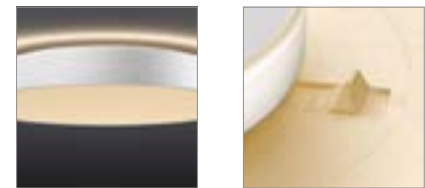

- With corona effect
- Colour temperature (3000K/4000K) selectable using a switch

Product details

220-240V ~50/60Hz | 1050mA
Total consumption: 40W
Material: Aluminium / Polycarbonate (PC)
Dimmable: Triac C

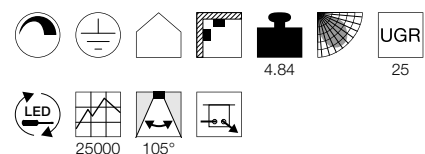

Dimensioned drawing

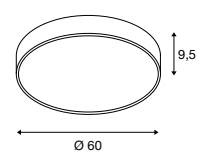

Note

Suspension set excl.

Recommended accessories

- Suspension set 1.5m
Item no. 135250
- Suspension set 1.5m
Item no. 135251
- Suspension set 1.5m
Item no. 135254
- Suspension set 5m
Item no. 1001950
- Suspension set 5m
Item no. 1001951
- Suspension set 5m
Item no. 1001952

Variant	Item no.
Down: 4350/4750lm 3000/4000K CRI>80 Up: 120lm 3000/4000K CRI>80	
■ black	1001886
Down: 4350/4750lm 3000/4000K CRI>80 Up: 120lm 3000/4000K CRI>80	
□ white	1001887
Down: 4350/4750lm 3000/4000K CRI>80 Up: 120lm 3000/4000K CRI>80	
■ grey	1001888

1002858 323



MALANG
CW, SLV VALETO®

A-A++ Range A++-E

LED INSIDE

NEW

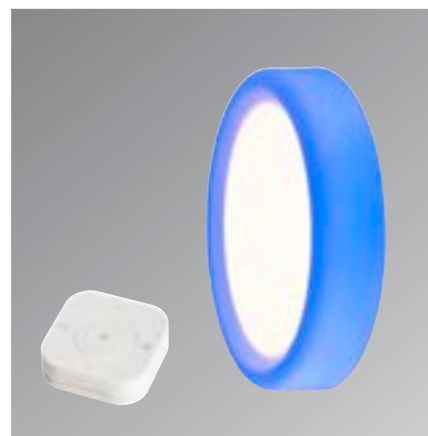

- Can be integrated in the SLV VALETO® system and other ZigBee® systems
- Panel can be controlled separately from warm white to cool white and dimmed
- The ring can be controlled separately in RGBW colours and dimmed

Product details

100-240V ~50/60Hz | 24V DC

Total consumption: 39W

Material: Aluminium / Polycarbonate (PC)

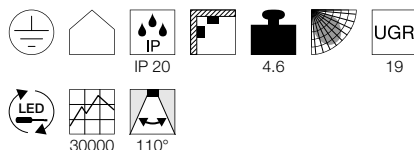

Dimensioned drawing

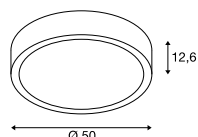

Note

Can be remote controlled and dimmed using SLV VALETO® CCT/RGBW remote control [1002994] or Gateway [1002411]

Recommended accessories

- Suspension set 1.5m
Item no. 135250
- Suspension set 1.5m
Item no. 135251
- Suspension set 1.5m
Item no. 135254
- Suspension set 5m
Item no. 1001950
- Suspension set 5m
Item no. 1001951
- Suspension set 5m
Item no. 1001952
- Remote control CCT/RGBW
Item no. 1002994

Variant	Item no.
Ring: 350lm RGB+W (3000K) CRI>80	
Panel: 2100-2400lm 2700-6500K CRI>80	
□ white	1002858

The decorative **RING** can be controlled separately. Create an atmospheric ambience by setting different light colours and dimming the light.

The **PANEL** can be controlled separately. You can set the colour temperature to 2700-6500K and dim the light.

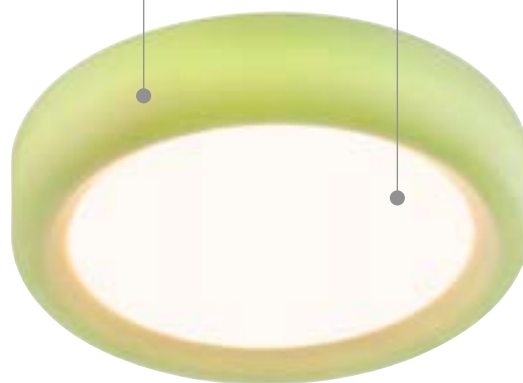

With our SLV VALETO® SMART LIGHT SYSTEM the choice is yours: Control your light at home with our SLV VALETO® remote control (1002994), or an app on your Smartphone via our SLV VALETO® Gateway (1002411).

Thanks to the latest ZigBee standard (ZigBee® 3.0) there are no limits to your smart light control.



Remote control
Item no. 1002994



Gateway
Item no. 1002411



SLV VALETO®
App

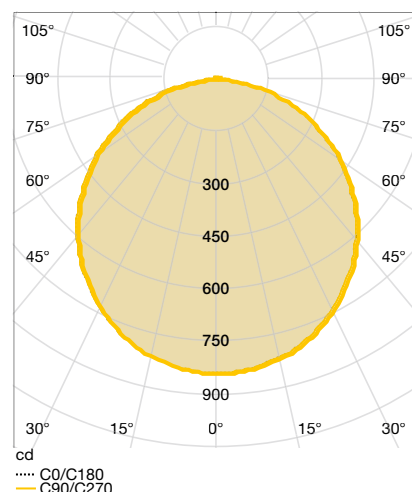
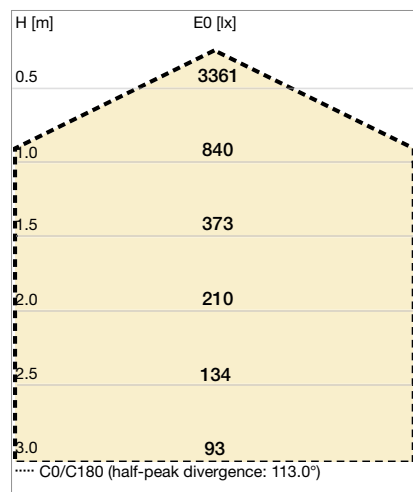

SENSER
CW, square, TRIAC



A-A++ Range
A++-E

Product details

220-240V ~50/60Hz
Material: Aluminium
Dimmable: Triac C

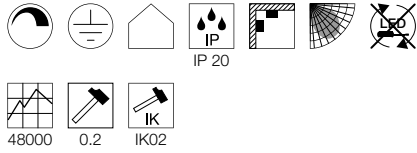

SENSER 12
CW, square, TRIAC



Dimensioned drawing

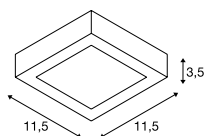

Variant	Item no.
480lm 3000K CRI>80 8,2W 0,27 kg □ matt white	1003017

SENSER 18
CW, square, TRIAC



Dimensioned drawing

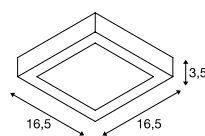

Variant	Item no.
880lm 3000K CRI>80 12W 0,39 kg □ matt white	1003018

SENSER 24
CW, square, TRIAC



Dimensioned drawing

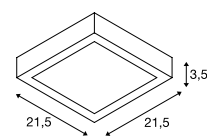

Variant	Item no.
1200lm 3000K CRI>80 15W 0,5 kg □ matt white	1003019

SENSER
CW, round, TRIAC



A-A++ Range A++-E

Product details

220-240V ~50/60Hz
Material: Aluminium
Dimmable: Triac C

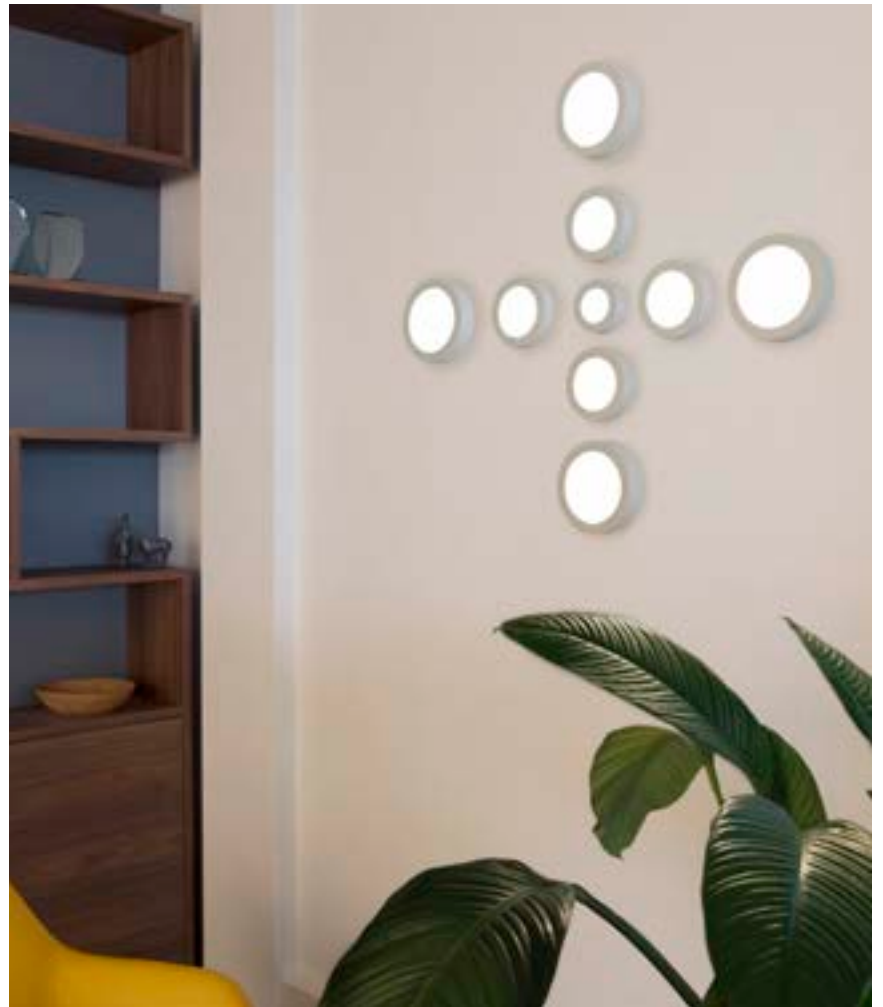
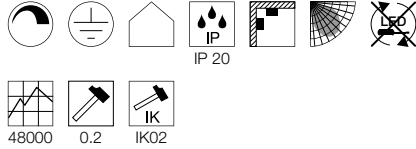

SENSER 12
CW, round, TRIAC



Dimensioned drawing

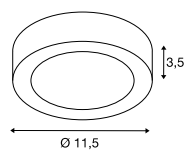

Variant	Item no.
480lm 3000K CRI>80 8.2W 0.23 kg □ matt white	1003014

SENSER 18
CW, round, TRIAC



Dimensioned drawing

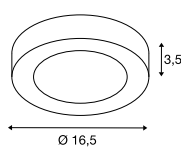

Variant	Item no.
880lm 3000K CRI>80 12W 0.34 kg □ matt white	1003015

SENSER 24
CW, round, TRIAC



Dimensioned drawing

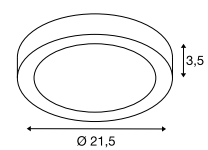

Variant	Item no.
1200lm 3000K CRI>80 15W 0.47 kg □ matt white	1003016



BENA Video



bit.ly/slv-bena





631347 327



631339 327

BENA 120
CW

A-A++ Range A++-E



- Simple installation

Product details

220-240V ~50/60Hz | 700mA
Total consumption: 28W
Material: Polymethylacrylate (PMMA) / Steel

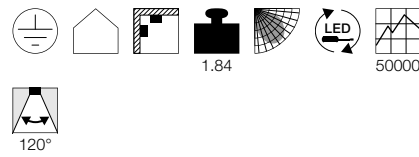

Dimensioned drawing

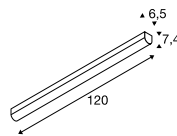

BENA 150
CW

A-A++ Range A++-E

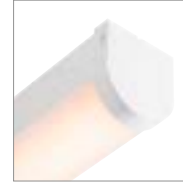

- Simple installation

Product details

220-240V ~50/60Hz | 700mA
Total consumption: 38W
Material: Polymethylacrylate (PMMA) / Steel

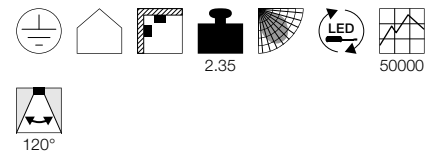

Dimensioned drawing

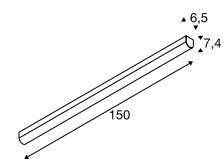

Variant	Item no.
3200lm 3000K CRI>80 □ white	631337
3400lm 4000K CRI>80 □ white	631347

Variant	Item no.
4400lm 3000K CRI>80 □ white	631339
4600lm 4000K CRI>80 □ white	631349

SIGHT 60
CW



A-A++ Range A++-E



• Switch on lamp housing

Product details

220-240V ~50/60Hz | 700mA
Total consumption: 20W
Material: Aluminium / Acrylic

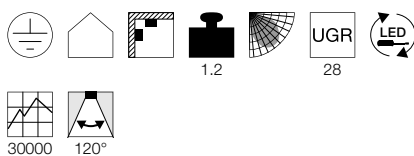

Dimensioned drawing

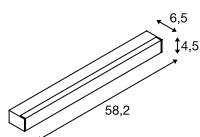

SIGHT 115
CW



A-A++ Range A++-E

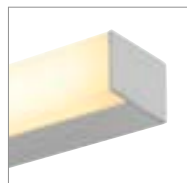

Product details

220-240V ~50/60Hz | 700mA
Total consumption: 37.3W
Material: Aluminium / Acrylic

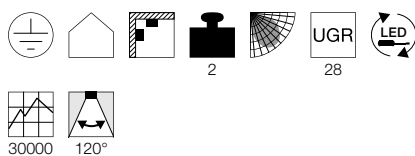

Dimensioned drawing

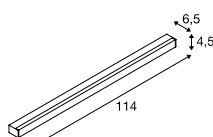

1001286 328



Variant	Item no.
1490lm 3000K CRI>80	
■ black	1001283
1490lm 3000K CRI>80	
□ white	1001284
1490lm 3000K CRI>80	
■ grey	1001285

Variant	Item no.
3100lm 3000K CRI>80	
■ black	1001286
3100lm 3000K CRI>80	
□ white	1001287
3100lm 3000K CRI>80	
■ grey	1001288

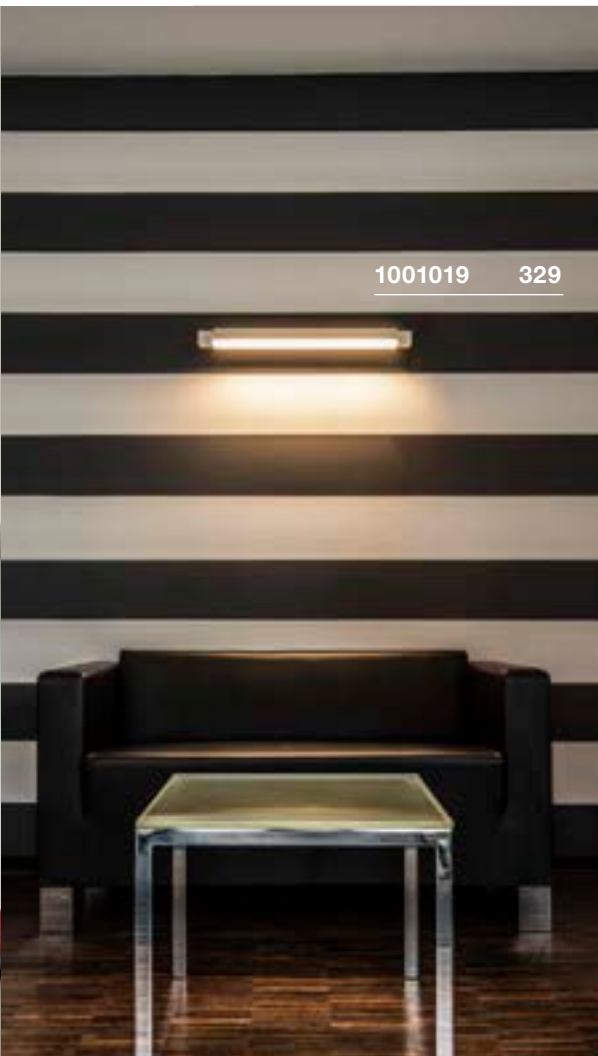

1001019 329



157660 329

LONG GRILL
CW

A-A++ Range A++-E

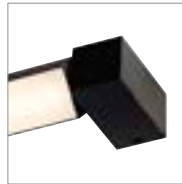

• Lamp unit, swivels by 270°

Product details

220-240V ~50/60Hz | 700mA
Total consumption: 20W
Material: Aluminium / Acrylic

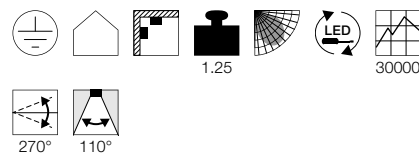

Dimensioned drawing

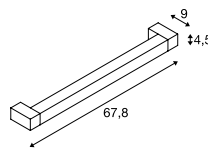

OPEN GRILL
CW

892

A-A++ Range A++-E



• Lamp unit, swivels by 270°

Product details

220-240V ~50/60Hz | 1050mA
Total consumption: 54W
Material: Aluminium / Acrylic

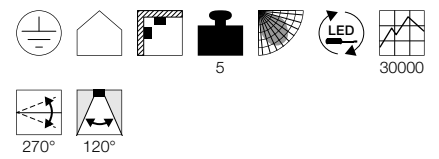

Dimensioned drawing

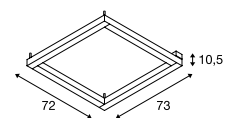

Variant	Item no.
1600lm 3000K CRI>80	
■ black	1001020
1600lm 3000K CRI>80	
□ white	1001019

Variant	Item no.
4500lm 3000K CRI>80	
■ black	1001293
4500lm 3000K CRI>80	
□ white	1001294

PROFESSIONAL IMPRESSION.

3-CIRCUIT HIGH-VOLTAGE TRACKS FOR NEW LIGHT EMPHASIS.

Well thought-out lighting is essential, particularly in locations where there is a lot to see. 3-circuit high-voltage tracks are ideal for shops and trade fair stands. They provide perfect lighting and put products and exhibits in the right light.

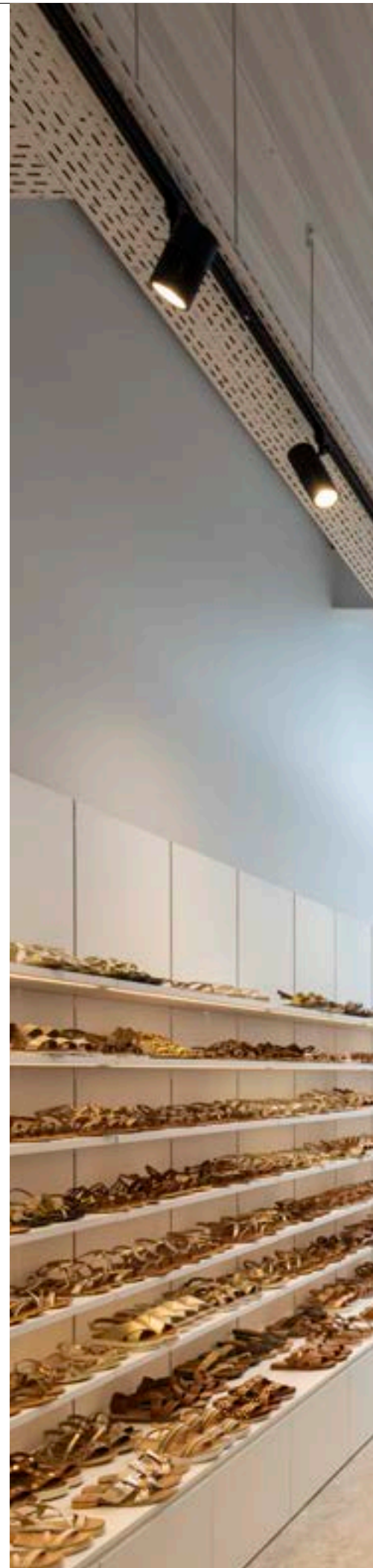

1003026 336





176081 356





1001269 348

240V TRACK, 3-CIRCUIT

 334	 334	 335	 336	 337	 342	 343	 343
 344	 344	 345	 345	 346	 346	 346	 348
 349	 349	 350	 351	 351	 351	 352	 352
 353	 353	 354	 355	 355	 356	 356	 356
 357	 358	 358	 359	 359	 360	 360	 361
 361	 361	 362	 363	 363	 363		

Suitable recessed and surface mounted track systems as well as accessories can be found on pages 339-341, 365-373

 Other luminaires and variants can be found online at www.slv.com

EURO SPOT TRACK
3-circuit, DALI, 235mm



A-A++ Range A++-E



NEW VARIANT



- Premium LED with CRI>90

Product details

220-240V ~50/60Hz | 1000mA
Total consumption: 42W
Material: Aluminium
Dimmable: Dali

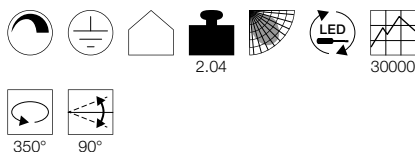

Dimensioned drawing

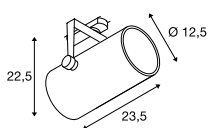

Variant	Item no.
2900lm 3000K CRI 15°	
■ black	1002809
□ white	1002810
3200lm 4000K CRI 15°	
■ black	1002811
□ white	1002812
2900lm 3000K CRI 38°	
■ black	1002813
□ white	1002814
3200lm 4000K CRI 38°	
■ black	1002815
□ white	1002816
2850lm 3000K CRI 60°	
■ black	1002817
□ white	1002818
3150lm 4000K CRI 60°	
■ black	1002819
□ white	1002820

EURO SPOT TRACK
3-circuit, DALI, 255mm



A-A++ Range A++-E



NEW VARIANT



- Premium LED with CRI>90

Product details

220-240V ~50/60Hz | 1200mA
Total consumption: 47W
Material: Aluminium
Dimmable: Dali

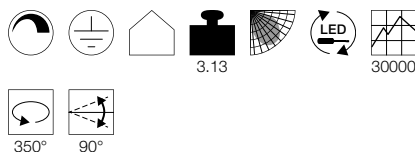

Dimensioned drawing

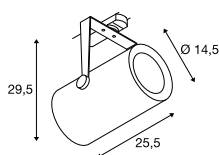

Variant	Item no.
4800lm 3000K CRI>90 40°	
■ black	1002663
□ white	1002664
4800lm 4000K CRI>90 40°	
■ black	1002665
□ white	1002666





1002667 335

EURO SPOT TRACK
3-circuit, DALI, 173mm



A-A++ Range A++-E

LED INSIDE

NEW VARIANT



- Premium LED with CRI>90

Product details

220-240V ~50/60Hz | 500mA
Total consumption: 20W
Material: Aluminium
Dimmable: Dali

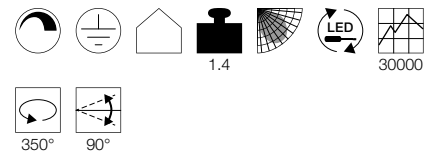

Dimensioned drawing

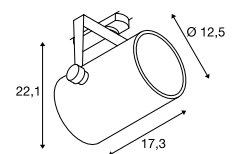

Variant	Item no.
1900lm 3000K CRI>90 15°	
■ black	1002667
□ white	1002668
1900lm 3000K CRI>90 38°	
■ black	1002669
□ white	1002670
1900lm 3000K CRI>90 60°	
■ black	1002671
□ white	1002672
2000lm 4000K CRI>90 15°	
■ black	1002673
□ white	1002674
2000lm 4000K CRI>90 38°	
■ black	1002675
□ white	1002676
2000lm 4000K CRI>90 60°	
■ black	1002677
□ white	1002678

STRUCTEC
3-circuit, DALI



1003025 336

A-A++ Range A++-E

LED INSIDE

NEW VARIANT



- Premium LED with CRI>90

Product details

200-240V ~50/60Hz | 700mA
Total consumption: 29W
Material: Aluminium
Dimmable: Dali

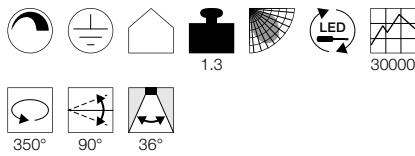

Dimensioned drawing

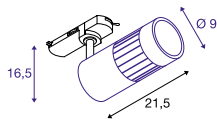

Variant	Item no.
2500lm 3000K CRI97	
■ matt black	1003024
2500lm 3000K CRI97	
□ matt white	1003025
2600lm 4000K CRI97	
■ matt black	1003026
2600lm 4000K CRI97	
□ matt white	1003027

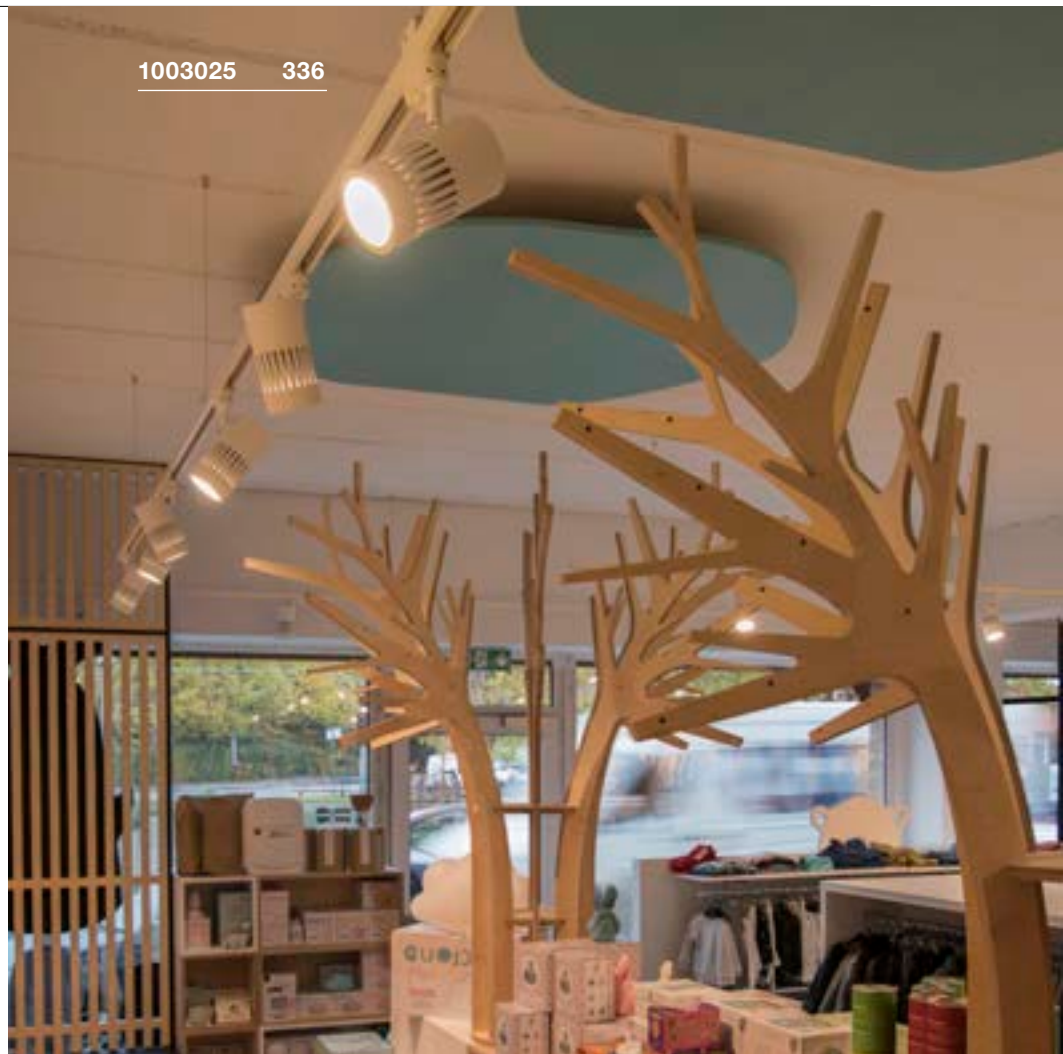



1002661 337

SIGHT TRACK
3-circuit, DALI
 895

A-A++

Range
A++-ENEW
VARIANT

Product details



220-240V 0/~50/60Hz | 700mA
 Total consumption: 40W
 Material: Aluminium / Acrylic
 Dimmable: Dali

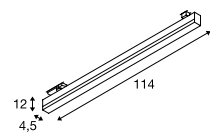

120°

Dimensioned drawing



Variant	Item no.
3100lm 3000K CRI>80	
■ black	1002661 
3100lm 3000K CRI>80	
□ white	1002662 



1002667 335



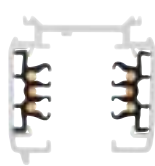

S-TRACK 3-CIRCUIT SURFACE-MOUNTED TRACK DALI



S-TRACK
3-circuit surface mounted track,
DALI, 2m



S-TRACK
3-circuit surface mounted track,
DALI, 2m



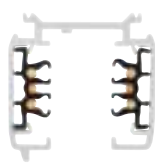

	 	 
Rated voltage	220-250V ~50/60Hz	220-250V ~50/60Hz
Max. perm. current	16A	16A
Mech. max. load	300N	300N
Mech. max. load	30 kg	30 kg
Feed-in capability	no	no
Material	Aluminium	Aluminium
Colour	black	white
Length	200 cm	200 cm
Width	3.6 cm	3.6 cm
Height	3.6 cm	3.6 cm
Weight	1.84 kg	1.84 kg
Item no.	1002631	1002632



S-TRACK
3-circuit surface mounted track,
DALI, 3m



S-TRACK
3-circuit surface mounted track,
DALI, 3m

	 	 
Rated voltage	220-250V ~50/60Hz	220-250V ~50/60Hz
Max. perm. current	16A	16A
Mech. max. load	300N	300N
Mech. max. load	30 kg	30 kg
Feed-in capability	no	no
Material	Aluminium	Aluminium
Colour	black	white
Length	300 cm	300 cm
Width	3.6 cm	3.6 cm
Height	3.6 cm	3.6 cm
Weight	2.76 kg	2.76 kg
Item no.	1002633	1002634



1001002 356

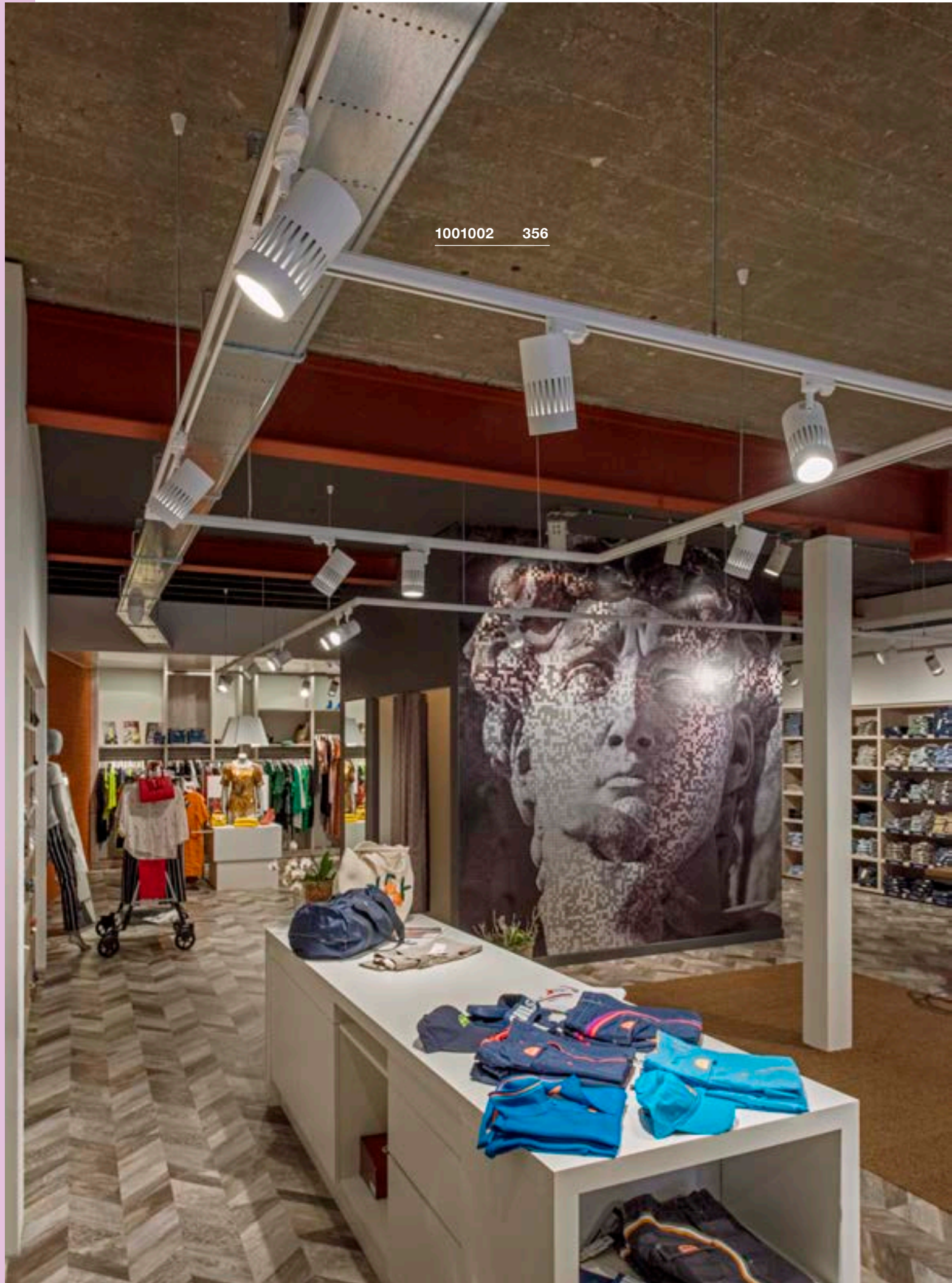

ACCESSORIES S-TRACK 3-CIRCUIT SURFACE-MOUNTED TRACK DALI

Feed-in, DALI, earth on left side

16A max.
Polycarbonate (PC)
L: 13.9 cm W: 3.5 cm H: 3.3 cm
Weight: 0.06 kg
1 pc.



Variant	Item no.
<input checked="" type="checkbox"/> black	1002638
<input type="checkbox"/> white	1002640

LT-connector, DALI, earth on outside

16A max.
Polycarbonate (PC)
L: 11.9 cm W: 11.9 cm H: 3.3 cm
Weight: 0.13 kg
1 pc.



Variant	Item no.
<input checked="" type="checkbox"/> black	1002648
<input type="checkbox"/> white	1002650

Ceiling suspension

Stainless Steel / Brass
L: 500 cm
Weight: 0.2 kg
Max. 10 kg
2 pcs.



Variant	Item no.
<input type="checkbox"/> nickel	1002845

Feed-in, DALI, earth on right side

10A max.
Polycarbonate (PC)
L: 13.9 cm W: 3.5 cm H: 3.3 cm
Weight: 0.06 kg
1 pc.



Variant	Item no.
<input checked="" type="checkbox"/> black	1002637
<input type="checkbox"/> white	1002639

T-connector, DALI, earth on right side

16A max.
Polycarbonate (PC)
L: 20.3 cm W: 11.9 cm H: 3.3 cm
Weight: 0.2 kg
1 pc.



Variant	Item no.
<input checked="" type="checkbox"/> black	1002651
<input type="checkbox"/> white	1002653

3-circuit adapter with hooks

Plastic / Steel
Ø: 2.6 cm H: 5.2 cm
Weight: 0.01 kg
Max. 10 kg
1 pc.



Variant	Item no.
<input checked="" type="checkbox"/> black	175190
<input type="checkbox"/> white	1001393

Mini connector, DALI

16A max.
Polycarbonate (PC)
L: 10.6 cm W: 2.5 cm H: 2.8 cm
Weight: 0.04 kg
1 pc.



Variant	Item no.
<input checked="" type="checkbox"/> black	1002641
<input type="checkbox"/> white	1002642

T-connector, DALI, earth on left side

16A max.
Polycarbonate (PC)
L: 20.3 cm W: 11.9 cm H: 3.3 cm
Weight: 0.2 kg
1 pc.



Variant	Item no.
<input checked="" type="checkbox"/> black	1002652
<input type="checkbox"/> white	1002654

Steel wire suspension kit with bar

Aluminium / Plastic
L: 100 cm W: 6 cm H: 4 cm
Weight: 0.2 kg
Max. 10 kg
1 pc.



Variant	Item no.
<input checked="" type="checkbox"/> black	175160
<input type="checkbox"/> white	1001390

Long connector, DALI

10A max.
Polycarbonate (PC)
L: 20.3 cm W: 3.5 cm H: 3.3 cm
Weight: 0.13 kg
1 pc.



Variant	Item no.
<input checked="" type="checkbox"/> black	1002643
<input type="checkbox"/> white	1002644

X-connector, DALI

16A max.
Polycarbonate (PC)
L: 20.3 cm W: 20.3 cm H: 3.3 cm
Weight: 0.27 kg
1 pc.



Variant	Item no.
<input checked="" type="checkbox"/> black	1002655
<input type="checkbox"/> white	1002656

End cap

Plastic
L: 3.5 cm W: 3.3 cm H: 3.2 cm
Weight: 0.01 kg
1 pc.



Variant	Item no.
<input checked="" type="checkbox"/> black	175060
<input type="checkbox"/> white	1001380

Flexible connector, DALI

16A max.
Polycarbonate (PC)
L: 28.5 cm W: 3.5 cm H: 3.3 cm
Weight: 0.18 kg
1 pc.



Variant	Item no.
<input checked="" type="checkbox"/> black	1002645
<input type="checkbox"/> white	1002646

Mounting clip, DALI

Steel
L: 4 cm W: 3.4 cm H: 1.25 cm
Weight: 0.02 kg
1 pc.



Variant	Item no.
<input checked="" type="checkbox"/> black	1002657
<input type="checkbox"/> white	1002658

L-connector, DALI, earth on inside

16A max.
Polycarbonate (PC)
L: 11.9 cm W: 11.9 cm H: 3.3 cm
Weight: 0.13 kg
1 pc.



Variant	Item no.
<input checked="" type="checkbox"/> black	1002647
<input type="checkbox"/> white	1002649

Adapter, DALI

10A max.
Polycarbonate (PC)
L: 11.3 cm W: 5.5 cm H: 3.3 cm
Weight: 0.062 kg
Max. 5 kg
1 pc.



Variant	Item no.
<input checked="" type="checkbox"/> black	1002660
<input type="checkbox"/> white	1002659

SPOT TRACK
3-circuit, E27



D-A+ Range
A++-E



- Stable joint

Product details

230V ~50Hz
Material: Aluminium

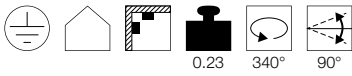

Dimensioned drawing

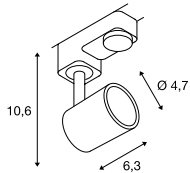

Recommended lamp

LED E27 11.5W 38°
3000K 760lm EEL=A+
12kWh/1000h
Item no. 551933



LED E27 17W 45°
3000K 1430lm EEL=A+
17kWh/1000h
Item no. 560473



Lamp details

max. 75W QPAR20
optional: QPAR30

Variant	Item no.
E27 QPAR20	
■ black	152200
E27 QPAR20	
□ white	152201
E27 QPAR20	
■ grey	152204

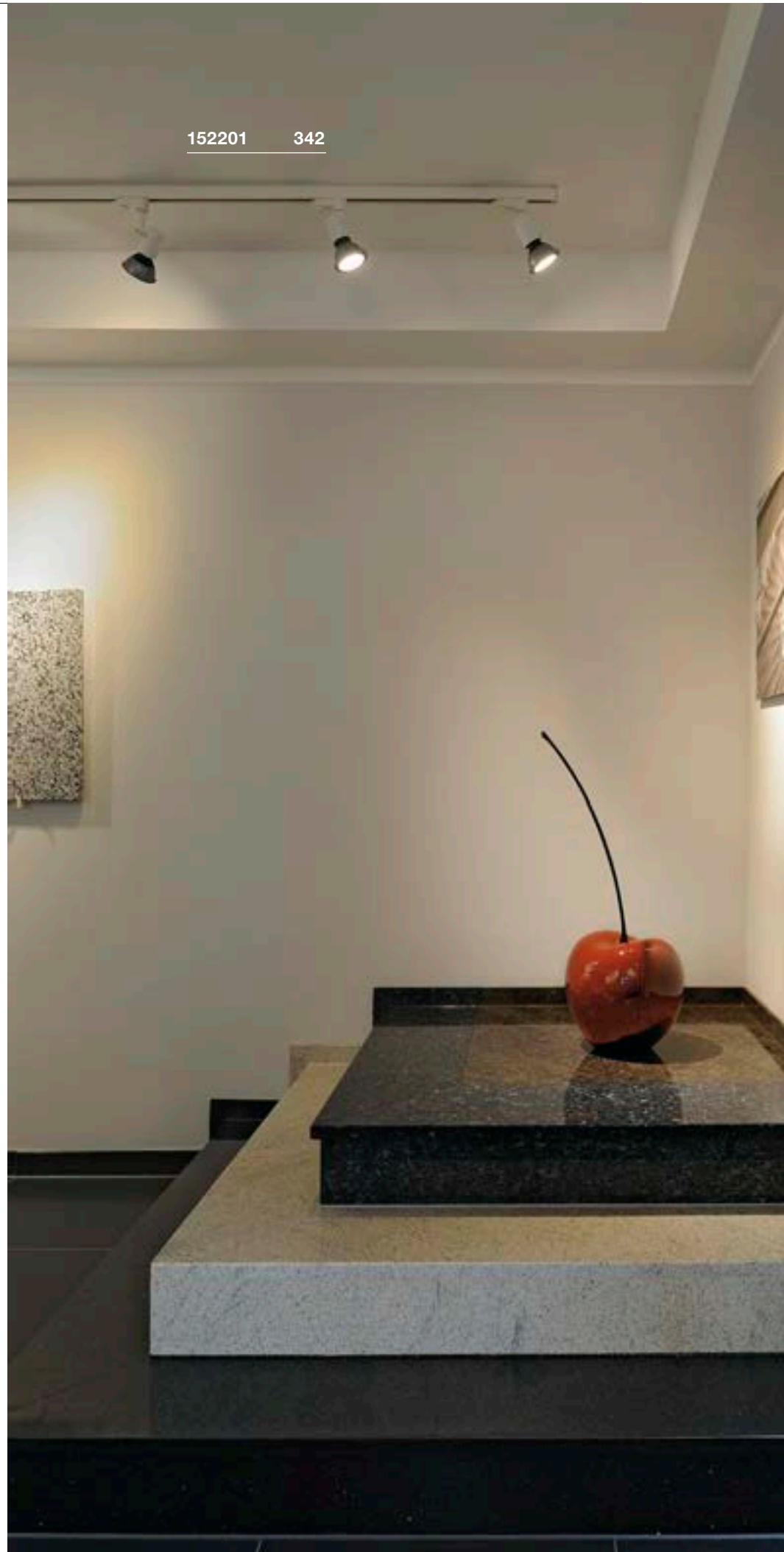

152201 342



152640 343



152640 343

AVO TRACK
3-circuit, QPAR51



E-A++ Range A++-E

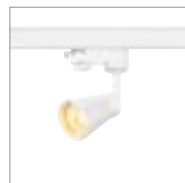

Product details

230V ~50/60Hz
Material: Steel

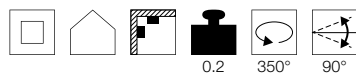

Dimensioned drawing

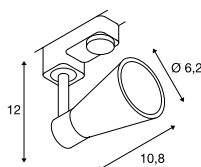

Recommended lamp

LED GU10 7.2W 36°
3000K 520lm EEL=A+
8kWh/1000h
Item no. 1001563



LED GU10 5.5W 38°
2700K 400lm EEL=A+
6kWh/1000h
Item no. 1001030



Lamp details

max. 50W QPAR51
Ø: 5 cm max.

Variant	Item no.
GU10 QPAR51	
■ black	152640
□ white	152641
■ grey	152644

ALTRA DICE TRACK
3-circuit, QPAR51



E-A++ Range A++-E



Product details

220-240V ~50/60Hz
Material: Aluminium

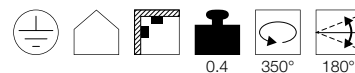

Dimensioned drawing

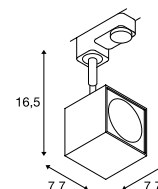

Recommended lamp

LED GU10 7.2W 36°
3000K 520lm EEL=A+
8kWh/1000h
Item no. 1001563



LED GU10 5.5W 38°
2700K 400lm EEL=A+
6kWh/1000h
Item no. 1001030



Lamp details

max. 50W QPAR51
Ø: 5 cm max. L: 5.7 cm max.

Variant	Item no.
GU10 QPAR51	
■ black	152320
□ white	152321
■ grey	152324

LIGHT EYE® 150
TRACK
3-circuit, QPAR51



E-A++ Range A++-E



• Luminaire unit, rotates by 350° and swivels by 90°

Product details

230V ~50Hz
Material: Steel

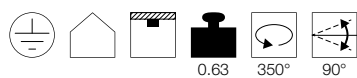

Dimensioned drawing

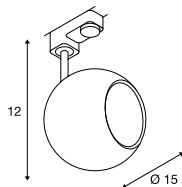

Recommended lamp

GU10 7W 25°
3000K 620lm EEL=A+
8kWh/1000h
Item no. 1001570



LED GU10 7.9W 40°
4000K 760lm EEL=A+
8kWh/1000h
Item no. 560724



Lamp details

max. 75W QPAR111

Variant	Item no.
GU10 QPAR111	
■ black	1000707
■ white / chrome	1000708
■ chrome	153102

PARA CONE 14
3-circuit, QPAR51



E-A++ Range A++-E

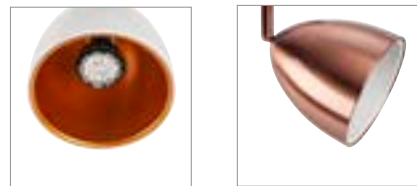

Product details

220-240V ~50/60Hz
Material: Steel
Product dimensions: Ø: 13.5 cm H: 22.50 cm



Dimensioned drawing

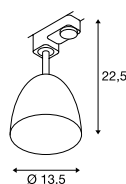

Lamp details

max. 25W QPAR51

Variant	Item no.
GU10	
■ shiny black	1002876
■ shiny white	1002877
■ copper	1002878

1000708 344



1002878 344





1001471 345

LENITO TRACK
3-circuit



A-A++ Range A++-E



- High efficient
- Wide, homogeneous lighting

Product details

220-240V ~50/60Hz | 160mA
Total consumption: 23W
Material: Aluminium / Polycarbonate (PC)

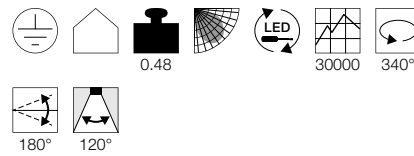

Dimensioned drawing

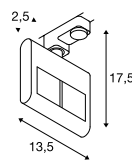

1001475 345

MERADO FLOOD TRACK
3-circuit, TRIAC



A-A++ Range A++-E



- Asymmetric light distribution
- For uniform lighting

Product details

220-240V ~50/60Hz | 1000mA
Total consumption: 40W
Material: Aluminium / Plastic
Dimmable: Triac C, Triac L

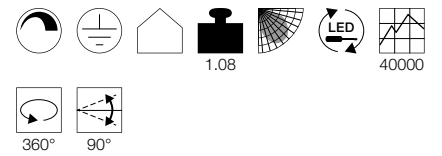

Dimensioned drawing

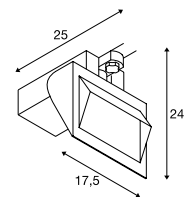

Variant	Item no.
2500lm 3000K CRI>80 □ white	1001466
2450lm 3000K CRI>80 ■ black	1001467

Variant	Item no.
3000lm 3000K CRI>80 □ white	1001470
3000lm 3000K CRI>80 ■ black	1001471
3200lm 4000K CRI>80 □ white	1001474
3200lm 4000K CRI>80 ■ black	1001475

HELIA 50 TRACK
3-circuit



A-A++ Range A++-E

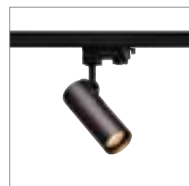

• Premium LED with CRI>90

Product details

220-240V ~50/60Hz | 500mA
Total consumption: 11W
Material: Aluminium

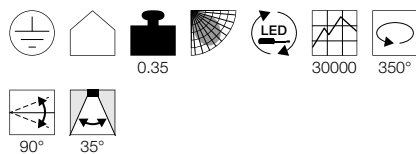

Dimensioned drawing

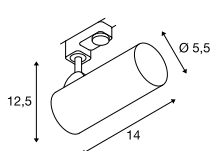

NOBLO SPOT
3-circuit



A-A++ Range A++-E



Product details

220-240V ~50/60Hz | 350mA
Total consumption: 7.5W
Material: Aluminium

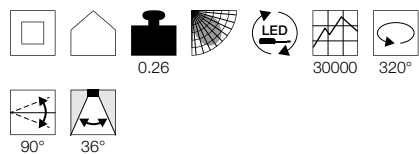

Dimensioned drawing

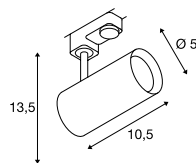

ENOLA C TRACK
3-circuit



A-A++ Range A++-E

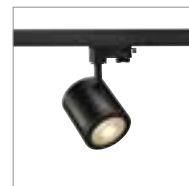

Product details

220-240V ~50/60Hz | 500mA
Total consumption: 12W
Material: Aluminium

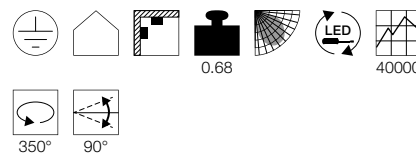

Dimensioned drawing

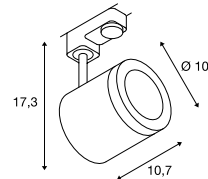

Variant	Item no.
750lm 3000K CRI>90	
■ black	152960
750lm 3000K CRI>90	
□ white	152961

Variant	Item no.
620lm 2700K CRI>80	
■ black	1001865
620lm 2700K CRI>80	
□ white	1001866
620lm 2700K CRI>80	
■ grey	1001867

Variant	Item no.
900lm 3000K CRI>80 35°	
■ black	152420
900lm 3000K CRI>80 35°	
□ white	152421
900lm 3000K CRI>80 55°	
■ black	152430
900lm 3000K CRI>80 55°	
□ white	152431



152960 346

1001431 268

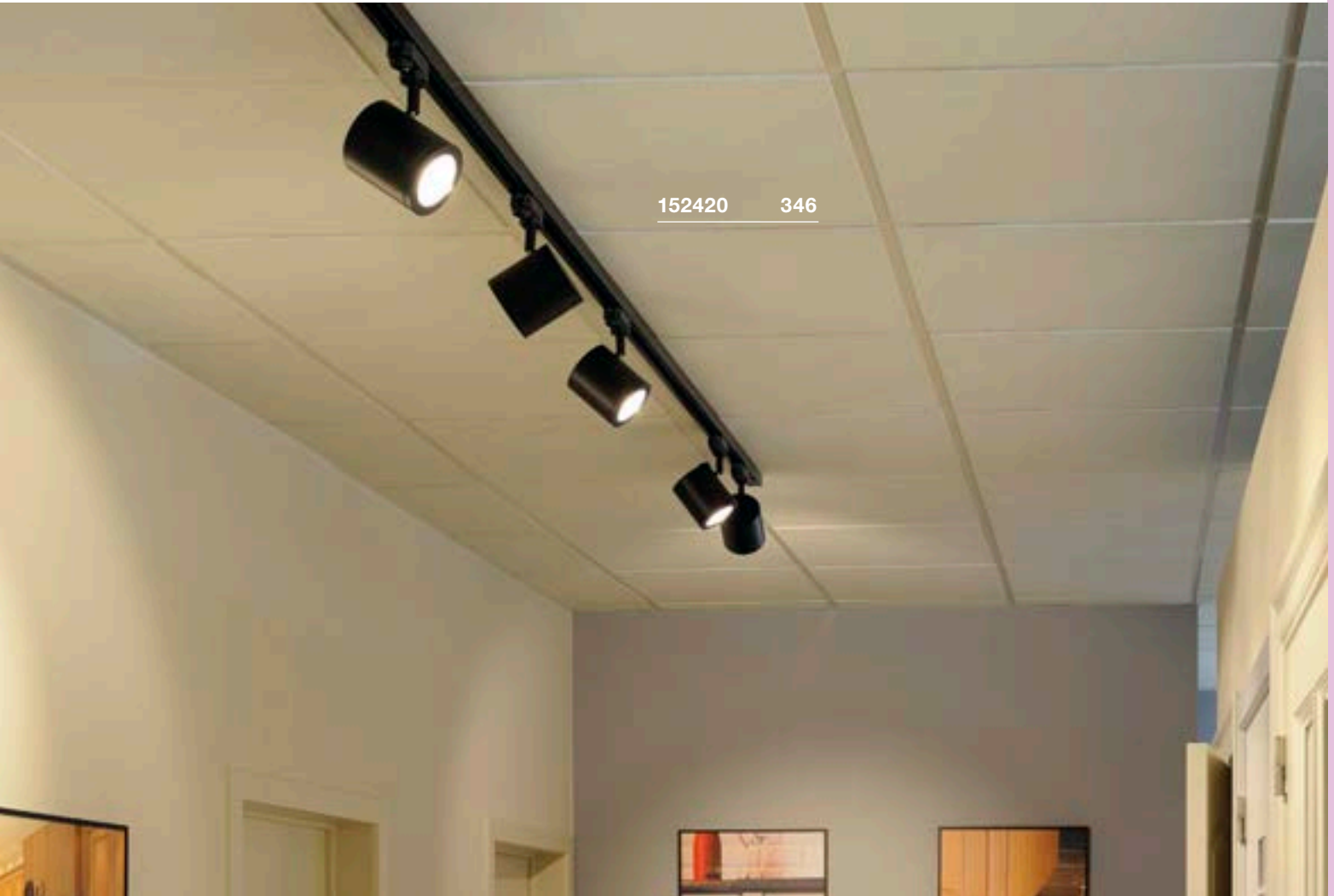

152420 346

SPOT T
3-circuit

A-A++ Range A++-E



1001269 348

Product details

220-240V ~50/60Hz

Total consumption: 39W

Material: Aluminium / Plastic



Dimensioned drawing

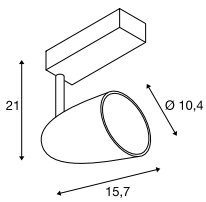

Variant	Item no.
3100lm 3000K CRI>80	
■ black	1001269
3100lm 3000K CRI>80	
□ white	1001270





152980 349

BILAS TRACK
3-circuit, TRIAC



A-A++ Range A++-E



• 240V LED

Product details

230V ~50/60Hz
Total consumption: 16W
Material: Aluminium / Glass
Dimmable: Triac C, Triac L

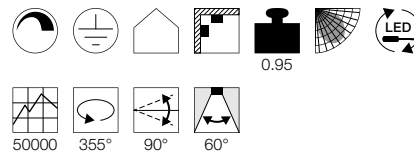

Dimensioned drawing

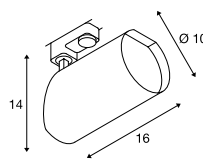

1001292 349

SIGHT TRACK
3-circuit



A-A++ Range A++-E



Product details

220-240V ~50/60Hz | 700mA
Total consumption: 37W
Material: Aluminium / Acrylic

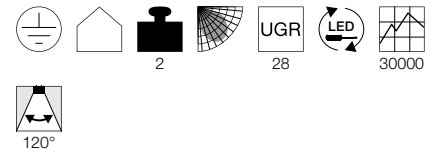

Dimensioned drawing

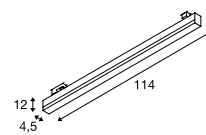

Variant	Item no.
1000lm 2700K CRI>80	
■ matt black	152980
1000lm 2700K CRI>80	
□ matt white	152981

Variant	Item no.
3100lm 3000K CRI>80	
■ black	1001289
3100lm 3000K CRI>80	
□ white	1001290
3100lm 3000K CRI>80	
■ grey	1001292

PURI TRACK
3-circuit, QPAR51



E-A++ Range A++-E



Product details

220-240V ~50/60Hz
Material: Aluminium / Polycarbonate (PC)

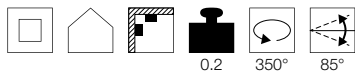

Dimensioned drawing

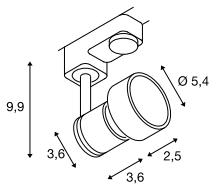

Recommended lamp

LED GU10 7.2W 36°
4000K 540lm EEL=A+
8kWh/1000h
Item no. **1001565**



LED GU10 7.2W 36°
2700K 520lm EEL=A+
8kWh/1000h
Item no. **1001560**



Lamp details

max. 50W QPAR51
Ø: 11 cm max. L: 7.8 cm max.
optional: QPAR111

Variant	Item no.
GU10 QPAR51	
■ matt black	153560
GU10 QPAR51	
□ white	153561
GU10 QPAR51	
■ grey	153564

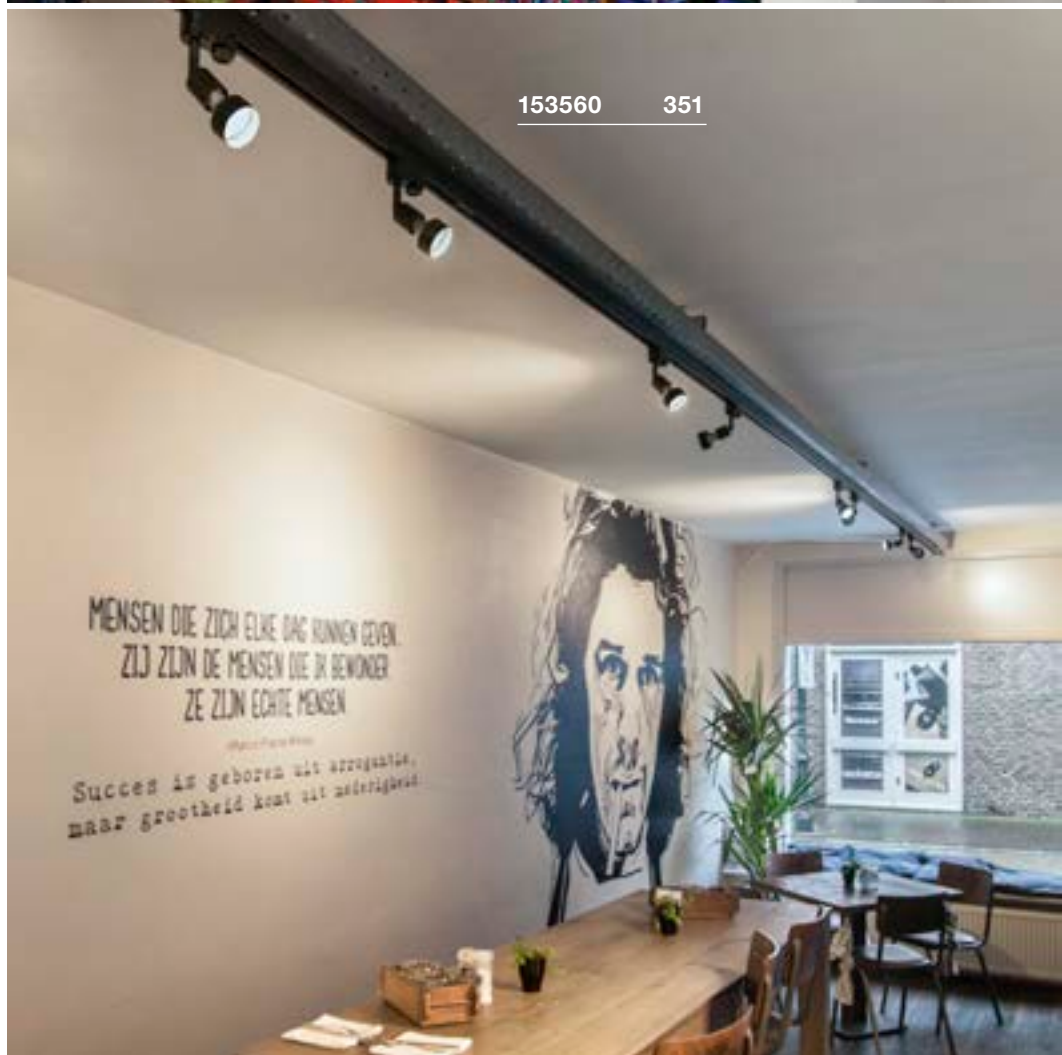

PURI TRACK
3-circuit, QPAR51



E-A++ Range A++-E



BIMA
3-circuit, single, QPAR51



E-A++ Range A++-E

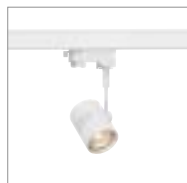
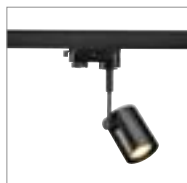

BIMA
3-circuit, double, QPAR51



E-A++ Range A++-E

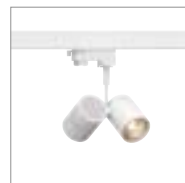
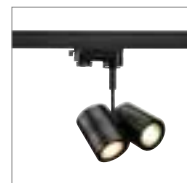

• The lamp heads can be swivelled in opposite directions

Product details

230V ~50Hz
Material: Aluminium / Plastic



0.3 340° 85°

Dimensioned drawing

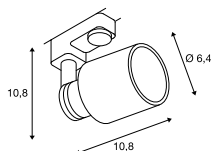

Product details

220-240V ~50/60Hz
Material: Aluminium

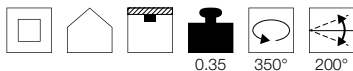

0.35 350° 200°

Dimensioned drawing

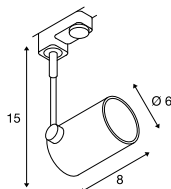

Product details

220-240V ~50/60Hz
Material: Aluminium

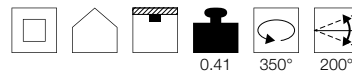

0.41 350° 200°

Dimensioned drawing

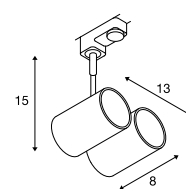

Recommended lamp

LED GU10 7.2W 36°
3000K 520lm EEL=A+
8kWh/1000h
Item no. 1001563



LED GU10 5.5W 38°
2700K 400lm EEL=A+
6kWh/1000h
Item no. 1001030



Lamp details

max. 10W QPAR51

Variant	Item no.
GU10 QPAR51	
■ black	1001871
GU10 QPAR51	
□ white	1001872
GU10 QPAR51	
■ grey	1001873

Recommended lamp

LED GU10 5.5W 38°
2700K 400lm EEL=A+
6kWh/1000h
Item no. 1001030



LED GU10 7.2W 36°
3000K 520lm EEL=A+
8kWh/1000h
Item no. 1001562



Lamp details

max. 50W QPAR51
Ø: 5 cm max. L: 5.7 cm max.

Variant	Item no.
GU10 QPAR51	
■ matt black	152240
GU10 QPAR51	
□ matt white	152241
GU10 QPAR51	
■ grey	152242

Recommended lamp

LED GU10 7.2W 36°
4000K 540lm EEL=A+
8kWh/1000h
Item no. 1001565



LED GU10 7.2W 36°
2700K 520lm EEL=A+
8kWh/1000h
Item no. 1001562



Lamp details

2x max. 50W QPAR51
Ø: 5 cm max. L: 5.7 cm max.

Variant	Item no.
GU10 QPAR51	
■ matt black	152230
GU10 QPAR51	
□ matt white	152231
GU10 QPAR51	
■ grey	152232

TEC KALU TRACK
3-circuit, double, TRIAC



A-A++ Range A++-E



TEC KALU TRACK
3-circuit, quad, TRIAC



A-A++ Range A++-E

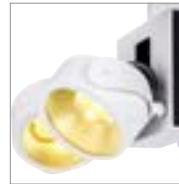

Product details

220-240V ~50/60Hz | 700mA
Total consumption: 31W
Material: Aluminium / Polycarbonate (PC)
Dimmable: Triac C

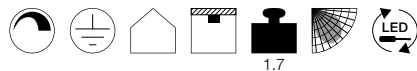

Dimensioned drawing

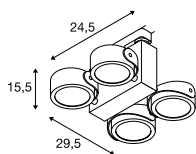

Product details

220-240V ~50/60Hz | 700mA
Total consumption: 60W
Material: Aluminium / Polycarbonate (PC)
Dimmable: Triac C

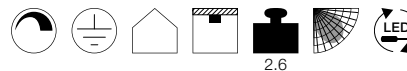

Dimensioned drawing

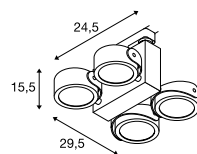

Variant	Item no.
1900lm 3000K CRI>80 24° ■ black	1001427
1900lm 3000K CRI>80 24° ■ white / black	1001428
1900lm 3000K CRI>80 60° ■ black	1001419
1900lm 3000K CRI>80 60° ■ white / black	1001420

Variant	Item no.
3800lm 3000K CRI>80 24° ■ black	1001429
3800lm 3000K CRI>80 24° ■ white / black	1001430
3800lm 3000K CRI>80 60° ■ black	1001421
3800lm 3000K CRI>80 60° ■ white / black	1001422



EURO CUBE
3-circuit



- Premium LED with CRI>90

Product details

220-240V ~50/60Hz
Total consumption: 28.5W
Material: Aluminium

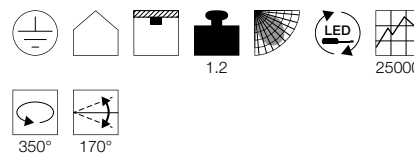

Dimensioned drawing

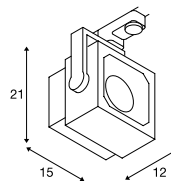

EURO CUBE
3-circuit



- Premium LED with CRI>90

Product details

220-240V ~50/60Hz
Total consumption: 28.5W
Material: Aluminium

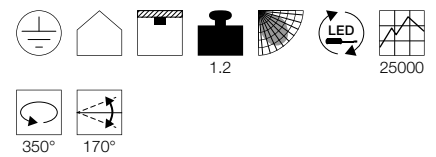

Dimensioned drawing

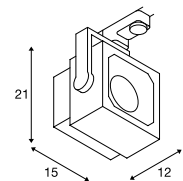

Variant	Item no.
2100lm 3000K CRI>90 60°	
■ black	152750
2100lm 3000K CRI>90 60°	
□ white	152751
2100lm 3000K CRI>90 60°	
■ grey	152754
1950lm 3000K CRI>90 90°	
■ black	152760
1950lm 3000K CRI>90 90°	
□ white	152761
1950lm 3000K CRI>90 90°	
■ grey	152764

Variant	Item no.
2150lm 4000K CRI>90 60°	
■ black	152780
2150lm 4000K CRI>90 60°	
□ white	152781
2150lm 4000K CRI>90 60°	
■ grey	152784
2050lm 4000K CRI>90 90°	
■ black	152790
2050lm 4000K CRI>90 90°	
□ white	152791
2050lm 4000K CRI>90 90°	
■ grey	152794

SUPROS 78 TRACK
3-circuit, TRIAC



A-A++ Range A++-E



152661 354

Product details

220-240V ~50/60Hz | 250mA
Total consumption: 12W
Material: Aluminium
Dimmable: Triac C, Triac L

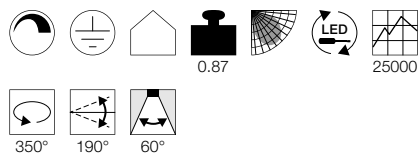

Dimensioned drawing

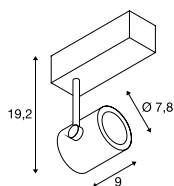

Recommended accessories

- Lens, 20°
Item no. 116302
- Lens, 40°
Item no. 116304
- Lamp shield
Item no. 1000677
- Lamp shield
Item no. 1000678

Variant	Item no.
700lm 3000K CRI>80	
■ black	152660
700lm 3000K CRI>80	
□ white	152661





SUPROS TRACK
3-circuit



A-A++ Range A++-E



Product details

220-240V ~50/60Hz | 750mA
Total consumption: 31W
Material: Aluminium

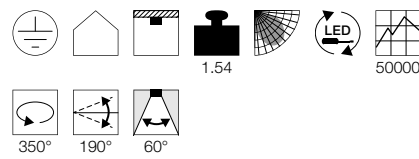

Dimensioned drawing

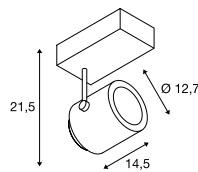

Note

Other colour temperatures available on request

Recommended accessories

- Lens, 20°
Item no. 116302
- Lens, 40°
Item no. 116304
- Lamp shield
Item no. 1000677
- Lamp shield
Item no. 1000678

Variant	Item no.
2600lm 3000K CRI>80 ■ black	152620
2600lm 3000K CRI>80 □ white	152621
2850lm 4000K CRI>80 ■ black	152680
2850lm 4000K CRI>80 □ white	152681

SUPROS TRACK
3-circuit



A-A++ Range A++-E



Product details

220-240V ~50/60Hz | 950mA
Total consumption: 36W
Material: Aluminium / Glass

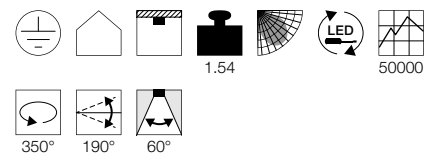

Dimensioned drawing

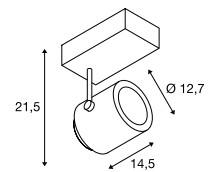

Note

Other colour temperatures available on request

Recommended accessories

- Lens, 20°
Item no. 116302
- Lens, 40°
Item no. 116304
- Lamp shield
Item no. 1000677
- Lamp shield
Item no. 1000678

Variant	Item no.
3100lm 3000K CRI>80 ■ black	152800
3100lm 3000K CRI>80 □ white	152801
3300lm 4000K CRI>80 ■ black	152810
3300lm 4000K CRI>80 □ white	152811

STRUCTEC
3-circuit



A-A++ Range A++-E



- Premium LED with CRI>90

Product details

220-240V ~50/60Hz
Total consumption: 28W
Material: Aluminium

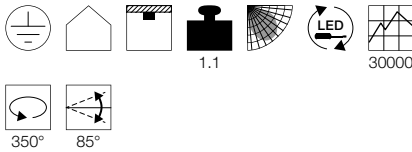

Dimensioned drawing

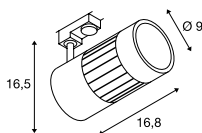

STRUCTEC
3-circuit



A-A++ Range A++-E

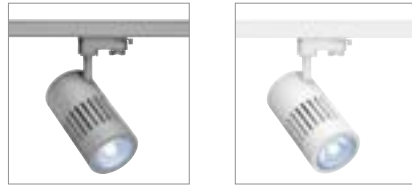

- Premium LED with CRI>90

Product details

220-240V ~50/60Hz
Total consumption: 35W
Material: Aluminium

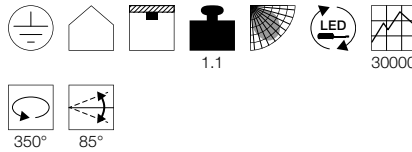

Dimensioned drawing

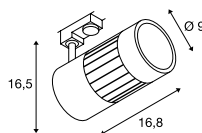

STRUCTEC
3-circuit, R9



A-A++ Range A++-E



- Premium LED
- High colour rendering characteristic R9/CRI>95
- Narrow design, versatile integration

Product details

220-240V ~50/60Hz | 900mA
Total consumption: 35W
Material: Aluminium

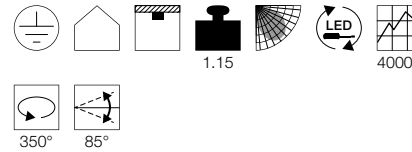

Dimensioned drawing

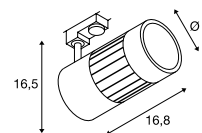

Variant	Item no.
2700lm 3000K CRI>90 36°	
■ black	1000980
2700lm 3000K CRI>90 36°	
□ white	1000981
2700lm 3000K CRI>90 36°	
■ grey	1000982
2650lm 3000K CRI>90 60°	
■ black	1000983
2650lm 3000K CRI>90 60°	
□ white	1000984
2650lm 3000K CRI>90 60°	
■ grey	1000985
2800lm 4000K CRI>90 36°	
■ black	1000986
2800lm 4000K CRI>90 36°	
□ white	1000987
2800lm 4000K CRI>90 36°	
■ grey	1000988
2750lm 4000K CRI>90 60°	
■ black	1000989
2750lm 4000K CRI>90 60°	
□ white	1000990
2750lm 4000K CRI>90 60°	
■ grey	1000991

Variant	Item no.
3200lm 3000K CRI>90 36°	
■ black	1000992
3200lm 3000K CRI>90 36°	
□ white	1000993
3200lm 3000K CRI>90 36°	
■ grey	1000994
3150lm 3000K CRI>90 60°	
■ black	1000995
3150lm 3000K CRI>90 60°	
□ white	1000996
3150lm 3000K CRI>90 60°	
■ grey	1000997
3450lm 4000K CRI>90 36°	
■ black	1000998
3450lm 4000K CRI>90 36°	
□ white	1000999
3400lm 4000K CRI>90 60°	
■ black	1001001
3400lm 4000K CRI>90 60°	
□ white	1001002
3400lm 4000K CRI>90 60°	
■ grey	1001003

Variant	Item no.
2460lm 3000K CRI>95 36°	
■ black	176080
2460lm 3000K CRI>95 36°	
□ white	176081
2250lm 3000K CRI>95 60°	
■ black	176090
2250lm 3000K CRI>95 60°	
□ white	176091



1000980 356

STRUCTEC ZOOM
3-circuit

896

A-A++ Range A++-E

LED INSIDE



- Premium LED with CRI>90
- Adjustable from 25° to 60°

Product details

220-240V ~50/60Hz
Total consumption: 35W
Material: Aluminium

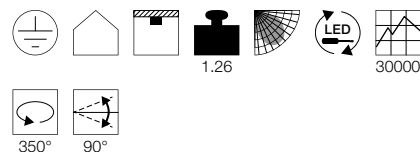

Dimensioned drawing

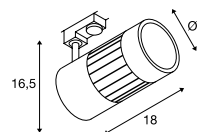

176081 356



1001002 356

Variant	Item no.
3000lm 3000K CRI>90	
■ black	1000656
3000lm 3000K CRI>90	
□ white	1000657
3000lm 3000K CRI>90	
■ grey	1000658

KALU TRACK
3-circuit, QPAR111



E-A++ Range A++-E

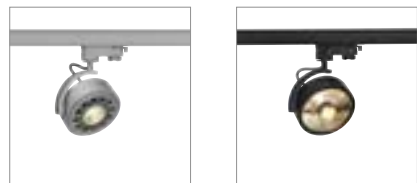

Product details

230V ~50Hz |
Material: Aluminium / Plastic

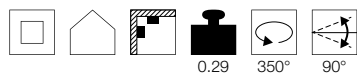

Dimensioned drawing

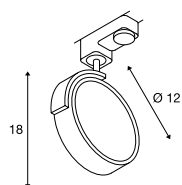

Recommended lamp

GU10 7.9W 40°
2700K 730lm EEL=A+
8kWh/1000h
Item no. 560732



LED GU10 13W 140°
4000K 1100lm EEL=A+
13kWh/1000h
Item no. 1001245



Lamp details

max. 75W QPAR111

Variant	Item no.
GU10 QPAR111	
■ black	152610
GU10 QPAR111	
□ white	152611
GU10 QPAR111	
■ grey	152614

KALU TRACK
3-circuit, QR111



D-A+ Range A++-E



Product details

230V ~50Hz | 12V AC
Material: Aluminium / Plastic

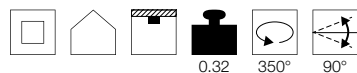

Dimensioned drawing

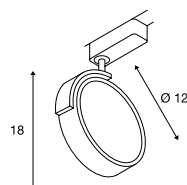

Recommended lamp

G53 15W 140°
2700K 680lm EEL=A
6kWh/1000h
Item no. 551612



LED G53 15W 40°
3000K 760lm EEL=A
17kWh/1000h
Item no. 560234



Lamp details

max. 50W QR111

Variant	Item no.
G53 QR111	
■ black	153580
G53 QR111	
□ white	153581
G53 QR111	
■ grey	153584



152614 358



153580 358



152601 359



153600 359

KALU TRACK
3-circuit, TRIAC



A-A++ Range A++-E



Product details

220-240V ~50/60Hz
Total consumption: 13W
Material: Aluminium
Dimmable: Triac C

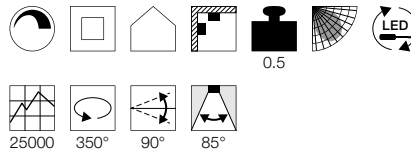

Dimensioned drawing

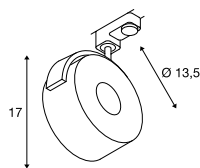

Variant	Item no.
860lm 3000K CRI>80	
■ black	152600
860lm 3000K CRI>80	
□ white	152601

KALU TRACK
3-circuit, TRIAC



A-A++ Range A++-E



Product details

220-240V ~50/60Hz | 350mA
Total consumption: 17W
Material: Aluminium / Polycarbonate (PC)
Dimmable: Triac C

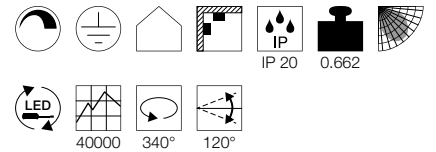

Dimensioned drawing

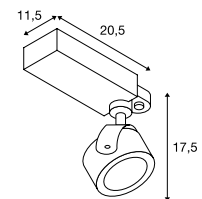

Variant	Item no.
1000lm 3000K CRI>80 24°	
■ black	153600
1000lm 3000K CRI>80 60°	
■ black	1000769

• Luminaire unit, can be rotated by 340° and swivelled by 120°

EURO SPOT TRACK
3-circuit, QPAR51



E-A++ Range A++-E



Product details

230V ~50Hz
Material: Aluminium / Glass

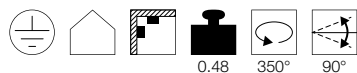

0.48 350° 90°

Dimensioned drawing

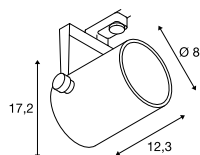

Recommended lamp

LED GU10 7.2W 36°
4000K 540lm EEL=A+
8kWh/1000h
Item no. 1001565



LED GU10 7W 25/40/55°
3000K 300lm EEL=A
7kWh/1000h
Item no. 560603



Lamp details

max. 25W QPAR51

Variant	Item no.
GU10 QPAR51	
■ black	153850
GU10 QPAR51	
□ white	153851
GU10 QPAR51	
■ grey	153854

EURO SPOT TRACK
3-circuit, QPAR111



E-A++ Range A++-E

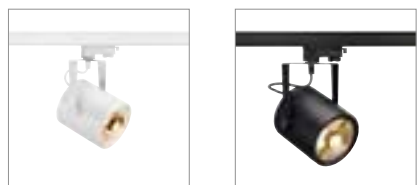

Product details

230V ~50Hz
Material: Aluminium

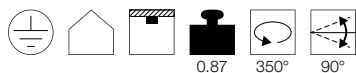

0.87 350° 90°

Dimensioned drawing

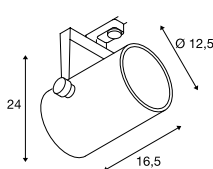

Recommended lamp

LED GU10 10W 38°
3000K 630lm EEL=A+
10kWh/1000h
Item no. 1001029



LED GU10 7W 13°
3000K 660lm EEL=A+
8kWh/1000h
Item no. 1001568



Lamp details

max. 75W QPAR111

Variant	Item no.
GU10 QPAR111	
■ black	153420
GU10 QPAR111	
□ white	153421
GU10 QPAR111	
■ grey	153424

153851 360



153810 361



EURO SPOT TRACK
3-circuit



A-A++ Range A++-E



Product details

220-240V ~50/60Hz
Total consumption: 11W
Material: Aluminium

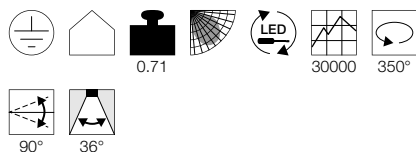

Dimensioned drawing

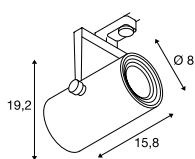

Variant	Item no.
650lm 3000K CRI>80 ■ black	1001367
650lm 3000K CRI>80 □ white	1001368
650lm 3000K CRI>80 ■ grey	1001369

EURO SPOT TRACK
3-circuit, TRIAC



A-A++ Range A++-E



Product details

220-240V ~50/60Hz
Total consumption: 21W
Material: Aluminium
Dimmable: Triac C, Triac L

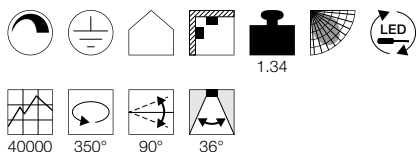

Dimensioned drawing

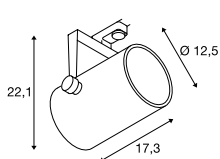

Variant	Item no.
1350lm 3000K CRI>80 ■ black	153810
1350lm 3000K CRI>80 □ white	153811
1350lm 3000K CRI>80 ■ grey	153814

EURO SPOT TRACK
3-circuit



A-A++ Range A++-E



Product details

220-240V ~50/60Hz | 1500mA
Total consumption: 61W
Material: Aluminium / Glass

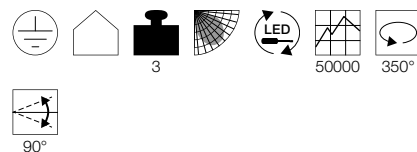

Dimensioned drawing

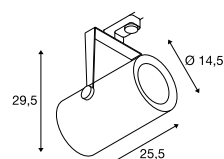

Variant	Item no.
5500lm 3000K CRI>80 12° ■ black	1001476
5500lm 3000K CRI>80 12° □ white	1001477
5500lm 3000K CRI>80 12° ■ grey / transparent	1001478
5500lm 3000K CRI>80 38° ■ black	1001484
5500lm 3000K CRI>80 38° □ white	1001480
5500lm 3000K CRI>80 38° ■ grey / transparent	1001479
5500lm 3000K CRI>80 60° ■ black	1001481
5500lm 3000K CRI>80 60° □ white	1001482
5500lm 3000K CRI>80 60° ■ grey / transparent	1001483

SIGHT TRACK
3-circuit, PD



A-A++ Range A++-E



Product details

220-240V ~50/60Hz | 700mA
Total consumption: 40W
Material: Aluminium / Acrylic

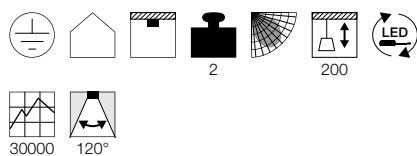

Dimensioned drawing

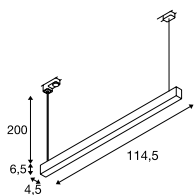

Variant	Item no.
3100lm 3000K CRI>80	
■ black	1002048
3100lm 3000K CRI>80	
□ white	1002049
3100lm 3000K CRI>80	
■ grey	1002050

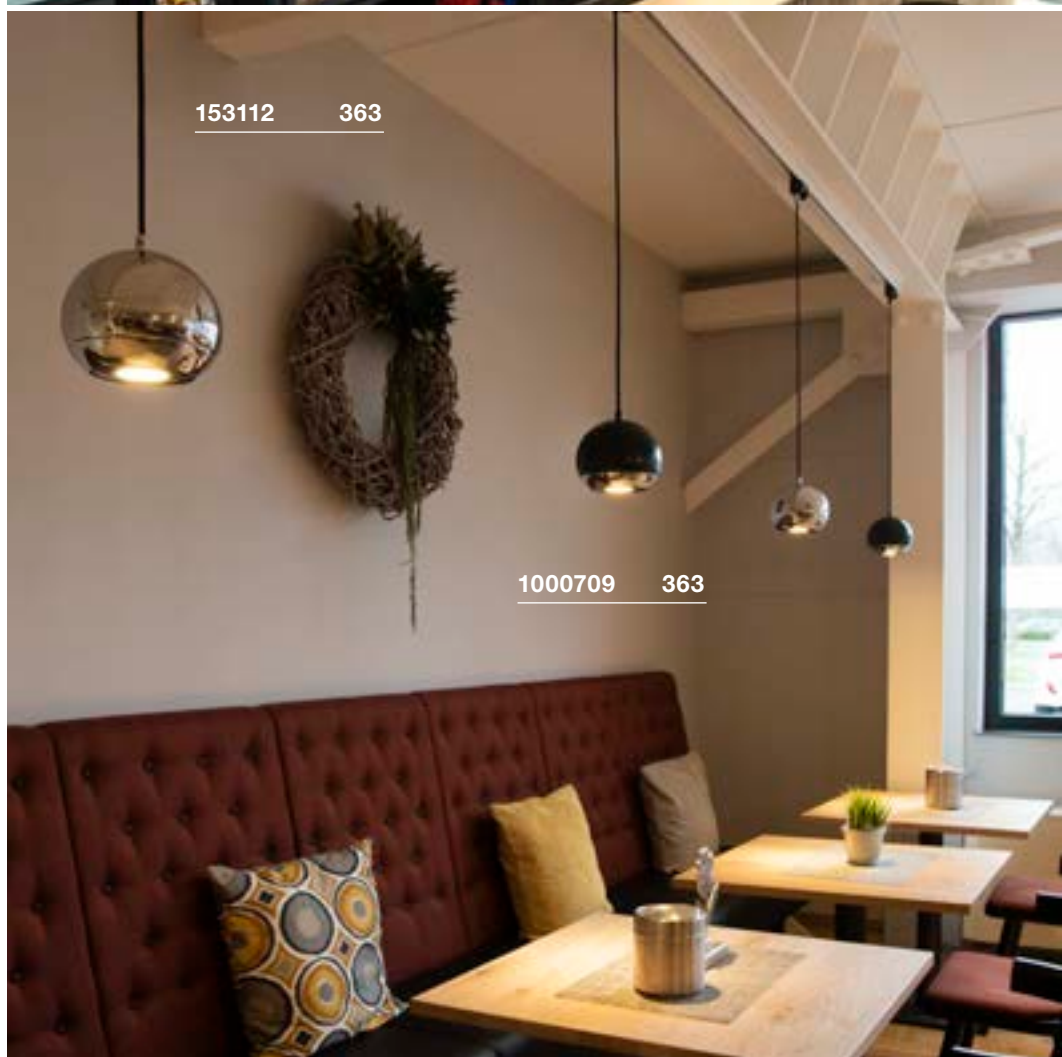
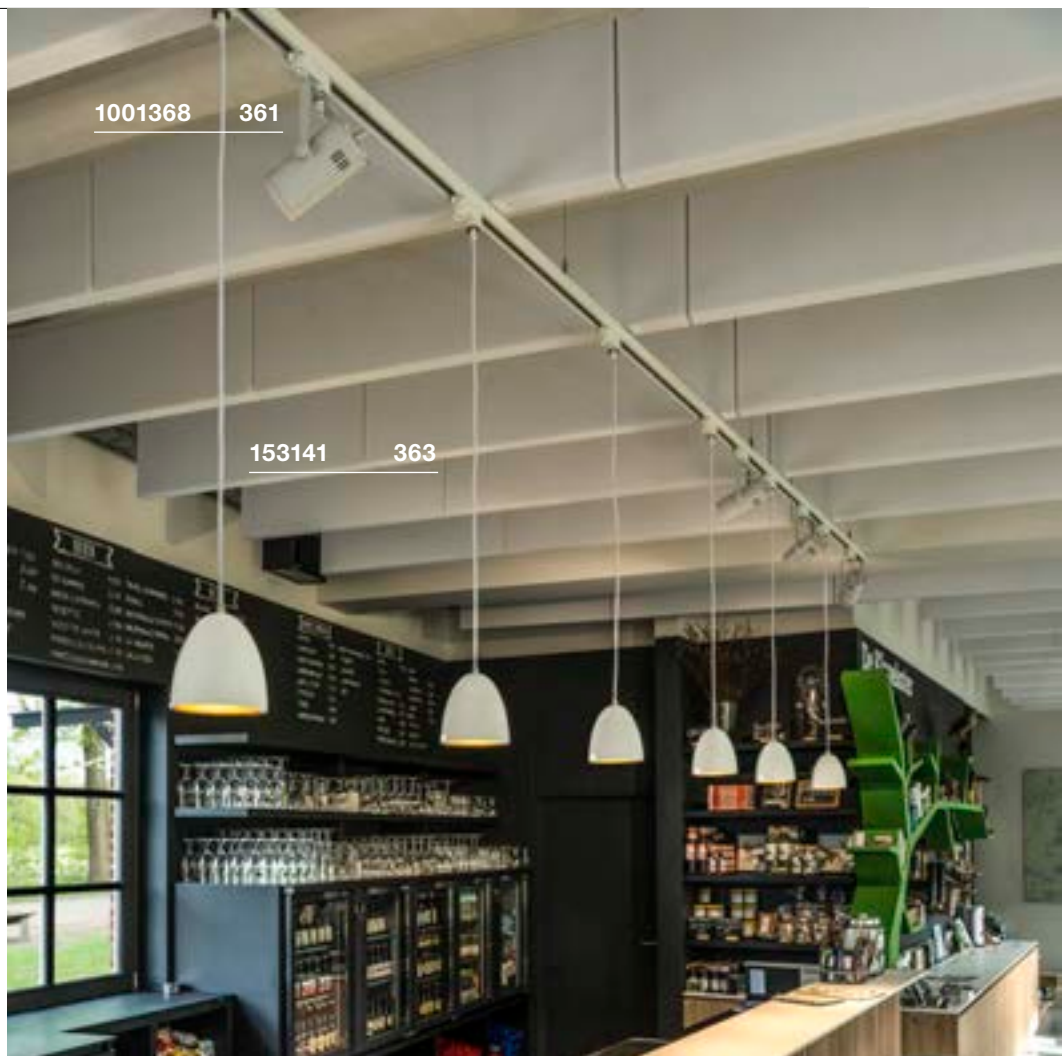

LIGHT EYE® 150
3-circuit, PD, QPAR111



E-A++ Range A++-E

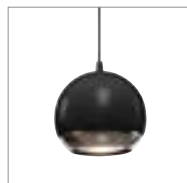

PARA CONE 14
3-circuit, PD, QPAR51



E-A++ Range A++-E

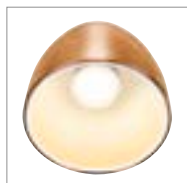

FORCHINI M 40 TRACK
3-circuit, PD, E27



E-A++ Range A++-E



- Double-walled design with internal reflector
- Textile cable in housing colour

Product details

230V ~50Hz
Material: Steel

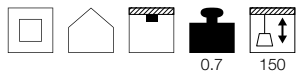

Dimensioned drawing

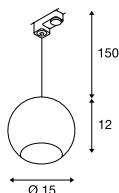

Product details

220-240V ~50/60Hz
Material: Aluminium

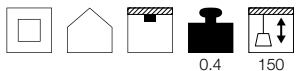

Dimensioned drawing

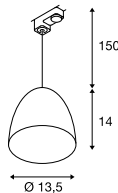

Product details

230V ~50Hz
Material: Aluminium / Steel

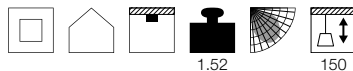

Dimensioned drawing

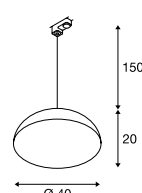

Recommended lamp

LED GU10 10W 38°
3000K 630lm EEL=A+
10kWh/1000h
Item no. 1001029



LED GU10 9.5W 25°
2200-6700K 750lm
Item no. 1001922



Lamp details

max. 75W QPAR111

Variant	Item no.
GU10 QPAR111	
■ black / chrome	1000709
GU10 QPAR111	
■ white / chrome	1000710
GU10 QPAR111	
■ chrome	153112

Recommended lamp

LED E27 7W 330°
2700K 806lm EEL=A+
8kWh/1000h
Item no. 1001035



LED E27 7W 280°
2200-2700K 830lm EEL=A++
7kWh/1000h
Item no. 1002126



Lamp details

max. 35W QPAR51

Variant	Item no.
GU10 QPAR51	
■ copper	1002686
GU10 QPAR51	
■ shiny black	153140
GU10 QPAR51	
□ white	153141

Lamp details

max. 40W
Ø: 6.8 cm max. L: 15.2 cm max.

Variant	Item no.
E27	
■ black / gold	153130
E27	
■ white/gold	153131

PLANNING AID FOR S-TRACK 3-CIRCUIT SURFACE MOUNTED TRACK

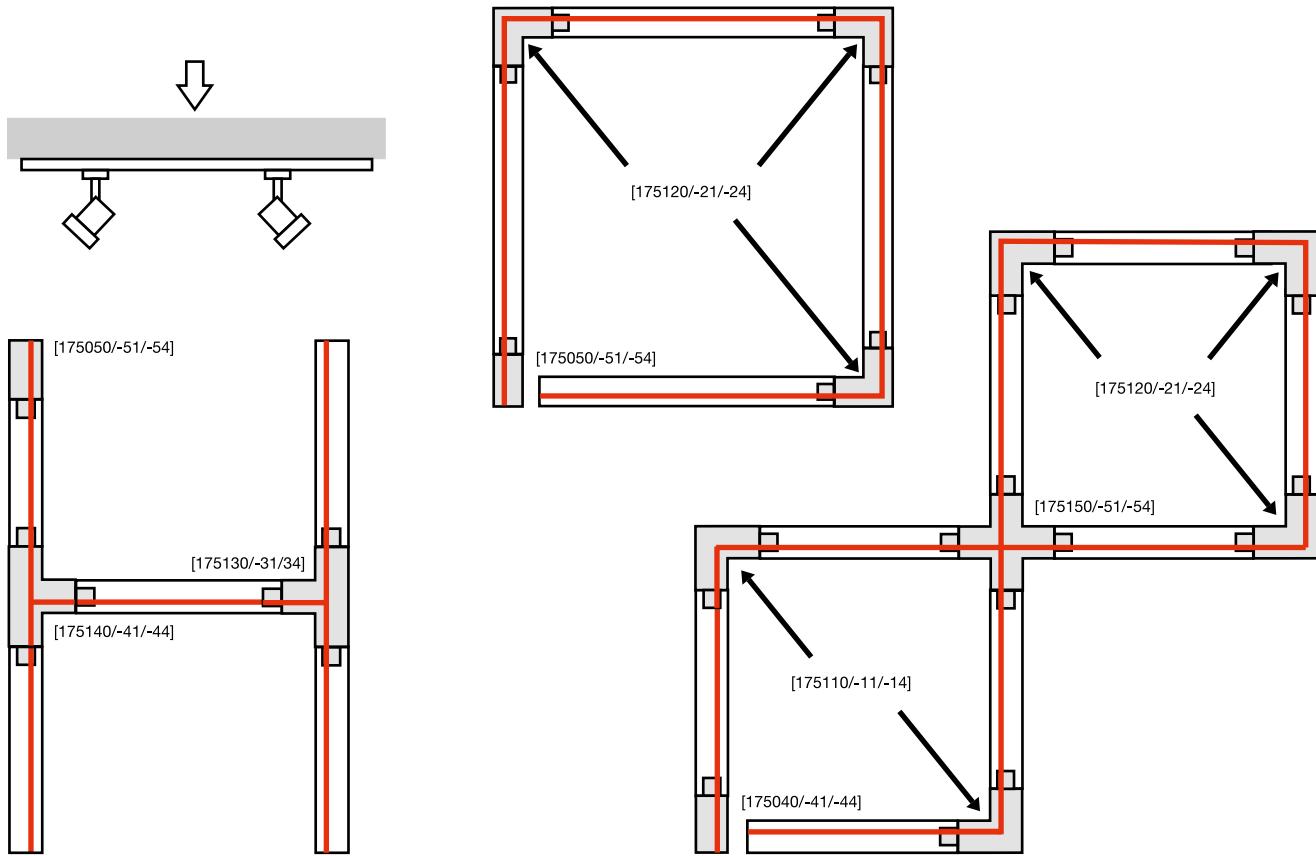

S-TRACK 3-CIRCUIT SURFACE MOUNTED TRACK





S-TRACK 3-circuit surface mounted track, 1m



S-TRACK 3-circuit surface mounted track, 1m



S-TRACK 3-circuit surface mounted track, 1m

			
Rated voltage	220-250V ~50Hz	220-250V ~50Hz	220-250V ~50Hz
Max. perm. current	16A	16A	16A
Feed-in capability	no	no	no
Material	Aluminium / Plastic	Aluminium / Plastic	-
Colour	black	white	-
Length	99.5 cm	99.5 cm	99.5 cm
Width	3.6 cm	3.6 cm	3.6 cm
Height	3.6 cm	3.6 cm	3.6 cm
Weight	0.9 kg	0.9 kg	0.9 kg
Item no.	175010	1001375	175014

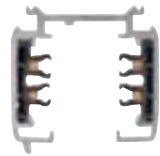



S-TRACK 3-circuit surface mounted track, 2m



S-TRACK 3-circuit surface mounted track, 2m



S-TRACK 3-circuit surface mounted track, 2m

			
Rated voltage	220-250V ~50Hz	220-250V ~50Hz	220-250V ~50Hz
Max. perm. current	16A	16A	16A
Feed-in capability	no	no	no
Material	Aluminium / Plastic	Aluminium / Plastic	-
Colour	black	white	-
Length	199.5 cm	199.5 cm	199.5 cm
Width	3.6 cm	3.6 cm	3.6 cm
Height	3.6 cm	3.6 cm	3.6 cm
Weight	1.8 kg	1.8 kg	1.8 kg
Item no.	175020	1001376	175024

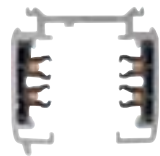



S-TRACK 3-circuit surface mounted track, 3m



S-TRACK 3-circuit surface mounted track, 3m



S-TRACK 3-circuit surface mounted track, 3m

			
Rated voltage	220-250V ~50Hz	220-250V ~50Hz	220-250V ~50Hz
Max. perm. current	16A	16A	16A
Feed-in capability	no	no	no
Material	Aluminium / Plastic	Aluminium / Plastic	-
Colour	black	white	-
Length	299.5 cm	299.5 cm	299.5 cm
Width	3.6 cm	3.6 cm	3.6 cm
Height	3.6 cm	3.6 cm	3.6 cm
Weight	2.7 kg	2.7 kg	2.7 kg
Item no.	175030	1001377	175034



152960 346

175100 367

ACCESSORIES FOR S-TRACK 3-CIRCUIT SURFACE MOUNTED TRACK

3-circuit adapter with hooks

Plastic / Steel
 Ø: 2.6 cm H: 5.2 cm
 Weight: 0.01 kg
 Max. 10 kg
 1 pc.



Variant	Item no.
■ black	175190
□ white	1001393
■ grey	175194

Mini connector

16A max.
 Aluminium / Plastic
 L: 6.8 cm W: 2.5 cm H: 2.6 cm
 Weight: 0.03 kg
 1 pc.



Variant	Item no.
■ black	175070
□ white	1001381
■ grey	175074

Mini connector, mechanical

Plastic
 L: 6.8 cm W: 3.1 cm H: 2.6 cm
 Weight: 0.02 kg
 1 pc.



Variant	Item no.
■ black	175080
□ white	1001382
■ grey	175084

Lamp adapter

16A max.
 Aluminium / Plastic
 L: 8.4 cm W: 5.5 cm H: 3.3 cm
 Weight: 0.08 kg
 Incl. strain relief
 Max. 10 kg
 1 pc.



Variant	Item no.
■ black	175200
□ white	1001394
■ grey	175204

L-connector, earth on inside

16A max.
 Aluminium / Plastic
 L: 6.7 cm W: 6.7 cm H: 3.3 cm
 Weight: 0.11 kg
 Earth electrode interior,
 with feed-in capability. 1 pc.



Variant	Item no.
■ black	175110
□ white	1001385
■ grey	175114

Flexible connector

16A max.
 Aluminium / Plastic
 L: 16.2 cm W: 3.5 cm H: 3.3 cm
 Weight: 0.14 kg
 1 pc.



Variant	Item no.
■ black	175100
□ white	1001384
■ grey	175104

Light adapter, mechanical

Aluminium / Plastic
 L: 6.6 cm W: 6.6 cm H: 3.1 cm
 Weight: 0.14 kg
 Max. 10 kg
 1 pc.



Variant	Item no.
■ black	175210
□ white	1001395
■ grey	175214

L-connector, earth on outside

16A max.
 Aluminium / Plastic
 L: 6.7 cm W: 6.7 cm H: 3.3 cm
 Weight: 0.11 kg
 Earth electrode exterior with feed-in
 capability. 1 pc.



Variant	Item no.
■ black	175120
□ white	1001386
■ grey	175124

Coupling joint connector

Aluminium
 L: 18.2 cm W: 3.3 cm H: 2.1 cm
 Weight: 0.08 kg
 1 pc.



Variant	Item no.
■ black	175180
□ white	1001392
■ grey	175184

Feed-in, earth on right side

16A max.
 Aluminium / Plastic
 L: 6.5 cm W: 3.5 cm H: 3.3 cm
 Weight: 0.06 kg
 Earth electrode, right-hand side.
 1 pc.



Variant	Item no.
■ black	175040
□ white	1001378
■ grey	175044

X-connector

16A max.
 Aluminium / Plastic
 L: 10 cm W: 10 cm H: 3.3 cm
 Weight: 0.23 kg
 2 power circuits.
 1 pc.



Variant	Item no.
■ black	175150
□ white	1001389
■ grey	175154

Ceiling suspension

Stainless Steel / Brass
 L: 500 cm
 Weight: 0.2 kg
 Max. 10 kg
 2 pcs.



Variant	Item no.
■ nickel	1002845

Feed-in, earth on left side

16A max.
 Aluminium / Plastic
 L: 6.5 cm W: 3.5 cm H: 3.3 cm
 Weight: 0.06 kg
 Earth electrode, left-hand side.
 1 pc.



Variant	Item no.
■ black	175050
□ white	1001379
■ grey	175054

T-connector, earth on left side

16A max.
 Aluminium / Plastic
 L: 10 cm W: 6.7 cm H: 3.3 cm
 Weight: 0.17 kg
 Earth electrode, left-hand side,
 with feed-in capability. 1 pc.



Variant	Item no.
■ black	175130
□ white	1001387
■ grey	175134

Steel wire suspension kit with bar

Aluminium / Plastic
 L: 100 cm W: 6 cm H: 4 cm
 Weight: 0.2 kg
 Max. 10 kg
 1 pc.



Variant	Item no.
■ black	175160
□ white	1001390
■ grey	175164

Long connector with feed-in capability

16A max.
 Aluminium / Plastic
 L: 9.9 cm W: 3.5 cm H: 3.3 cm
 Weight: 0.11 kg
 With feed-in capability.
 1 pc.



Variant	Item no.
■ black	175090
□ white	1001383
■ grey	175094

T-connector, earth on right

16A max.
 Aluminium / Plastic
 L: 10 cm W: 6.7 cm H: 3.3 cm
 Weight: 0.17 kg
 Earth electrode, right-hand side,
 with feed-in capability. 1 pc.



Variant	Item no.
■ black	175140
□ white	1001388
■ grey	175144

End cap

Plastic
 L: 3.5 cm W: 3.3 cm H: 3.2 cm
 Weight: 0.01 kg
 1 pc.



Variant	Item no.
■ black	175060
□ white	1001380
■ grey	175064

PLANNING AID FOR EUTRAC® 3-CIRCUIT SURFACE MOUNTED TRACK

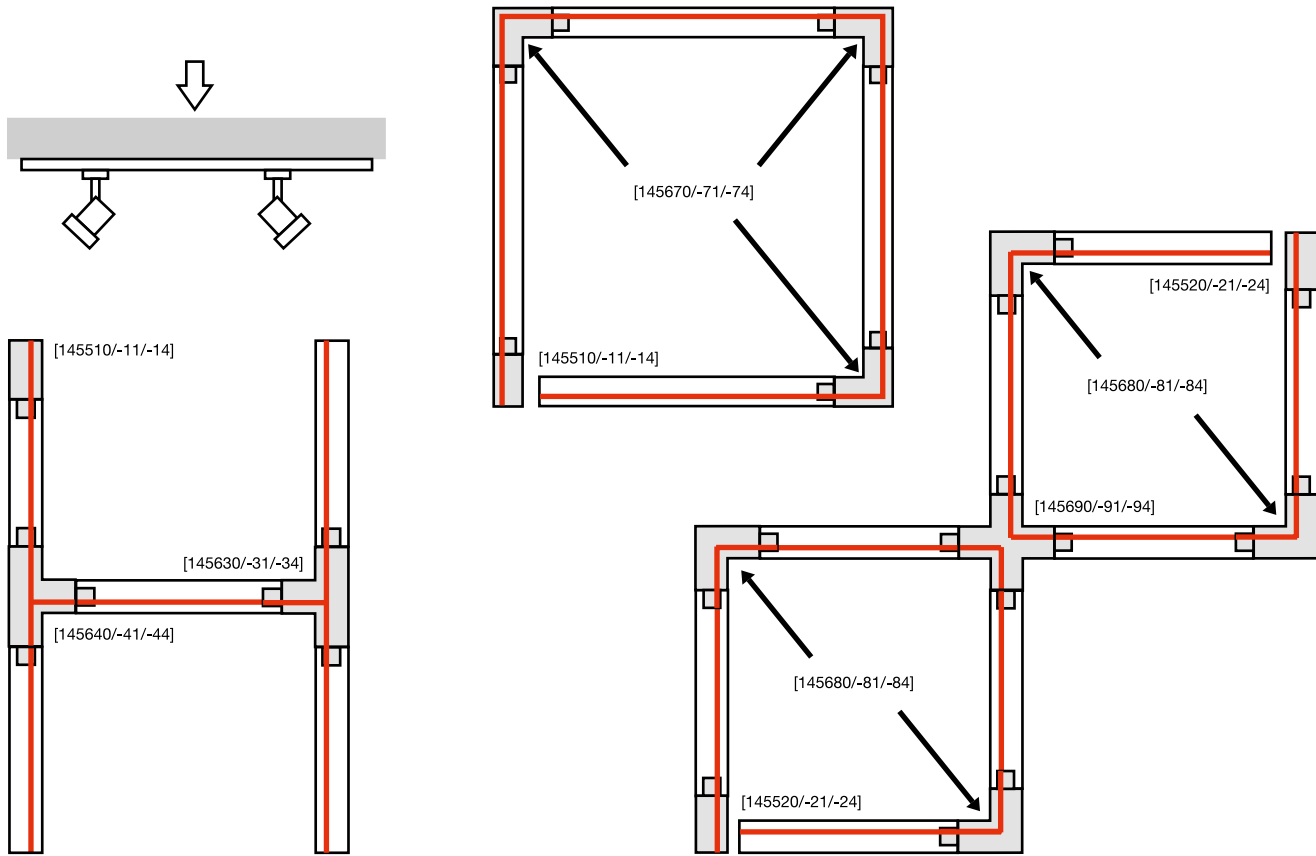

EUTRAC® 3-CIRCUIT SURFACE MOUNTED TRACK

	EUTRAC® 3-circuit surface mounted track, 1m	EUTRAC® 3-circuit surface mounted track, 1m	EUTRAC® 3-circuit surface mounted track, 1m
Rated voltage	230V ~50Hz	230V ~50Hz	230V ~50Hz
Max. perm. current	16A	16A	16A
Feed-in capability	no	no	no
Material	Aluminium / Plastic	Aluminium / Plastic	Aluminium / Plastic
Colour	black	white	grey
Length	100 cm	100 cm	100 cm
Width	3.6 cm	3.6 cm	3.6 cm
Height	3.2 cm	3.2 cm	3.2 cm
Weight	1 kg	1 kg	1 kg
Item no.	145100	1001510	145102

	EUTRAC® 3-circuit surface mounted track, 2m	EUTRAC® 3-circuit surface mounted track, 2m	EUTRAC® 3-circuit surface mounted track, 2m
Rated voltage	230V ~50Hz	230V ~50Hz	230V ~50Hz
Max. perm. current	16A	16A	16A
Feed-in capability	no	no	no
Material	Aluminium / Plastic	Aluminium / Plastic	Aluminium / Plastic
Colour	black	white	grey
Length	200 cm	200 cm	200 cm
Width	3.6 cm	3.6 cm	3.6 cm
Height	3.2 cm	3.2 cm	3.2 cm
Weight	2 kg	2 kg	2 kg
Item no.	145200	1001511	145202

	EUTRAC® 3-circuit surface mounted track, 3m	EUTRAC® 3-circuit surface mounted track, 3m	EUTRAC® 3-circuit surface mounted track, 3m
Rated voltage	230V ~50Hz	230V ~50Hz	230V ~50Hz
Max. perm. current	16A	16A	16A
Feed-in capability	no	no	no
Material	Aluminium / Plastic	Aluminium / Plastic	Aluminium / Plastic
Colour	black	white	grey
Length	300 cm	300 cm	300 cm
Width	3.6 cm	3.6 cm	3.6 cm
Height	3.2 cm	3.2 cm	3.2 cm
Weight	3 kg	3 kg	3 kg
Item no.	145300	1001512	145302

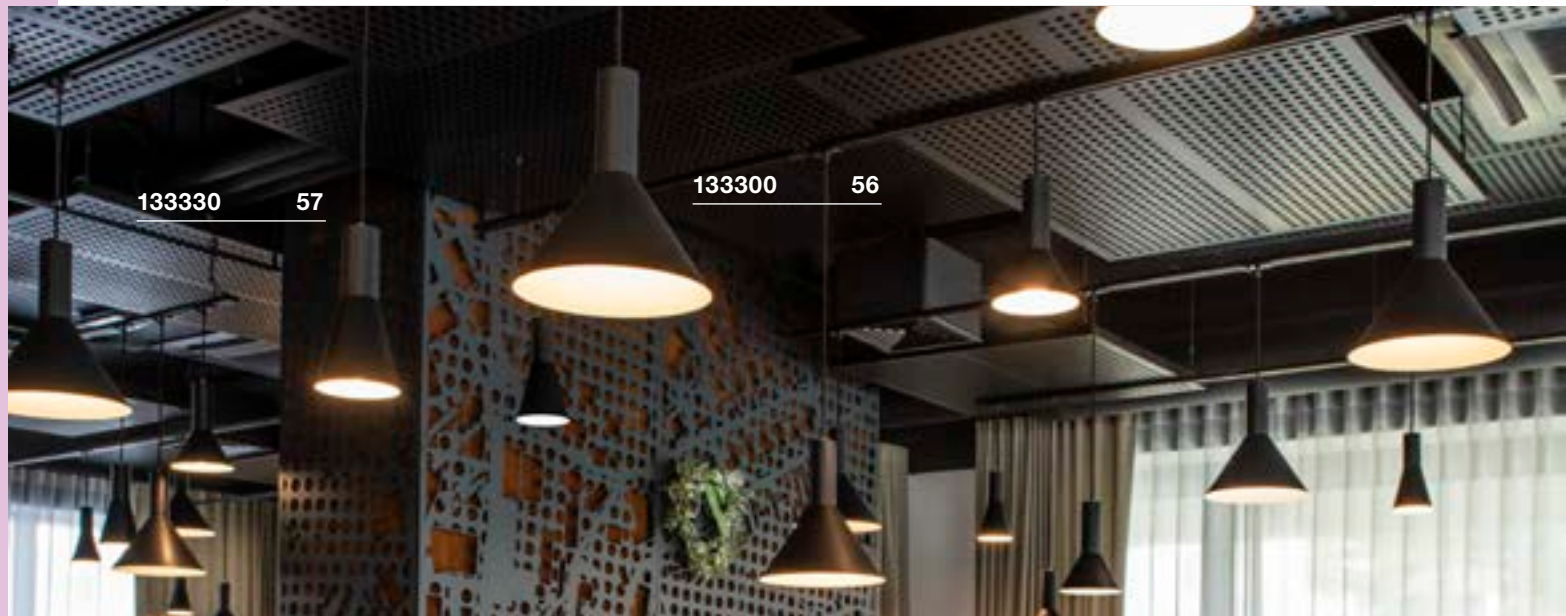

133330

57

133300

56

ACCESSORIES FOR EUTRAC® 3-CIRCUIT SURFACE MOUNTED TRACK

Feed-in, left

16A max.
Plastic
L: 11.2 cm W: 3.6 cm H: 3.2 cm
Weight: 0.08 kg
Earth electrode, on left-hand side.
1 pc.



Variant	Item no.
■ black	145510
□ white	1001513
■ grey	145514

Long connector with feed-in capability

16A max.
Plastic / Steel
L: 26 cm W: 3.6 cm H: 3.2 cm
Weight: 0.15 kg
1 pc.



Variant	Item no.
■ black	145660
□ white	1001517
■ grey	145664

Feed-in, right

16A max.
Plastic
L: 11.2 cm W: 3.6 cm H: 3.2 cm
Weight: 0.08 kg
Earth electrode, right-hand side
1 pc.



Variant	Item no.
■ black	145520
□ white	1001514
■ grey	145524

T-connector, earth electrode on left

16A max.
Plastic / Steel
L: 26 cm W: 18.5 cm H: 3.2 cm
Weight: 0.35 kg
1 pc.



Variant	Item no.
■ black	145630
□ white	1001518
■ grey	145634

Centre feed-in

16A max.
Plastic
L: 13 cm W: 3.6 cm H: 3.6 cm
Weight: 0.08 kg
1 pc.



Variant	Item no.
■ black	145530
□ white	1001515
■ grey	145534

T-connector, earth electrode on right

16A max.
Plastic / Steel
L: 26 cm W: 18.5 cm H: 3.2 cm
Weight: 0.35 kg
1 pc.



Variant	Item no.
■ black	145640
□ white	1001519
■ grey	145644

Long connector

16A max.
Plastic
L: 5.8 cm W: 1.5 cm H: 2.6 cm
Weight: 0.03 kg
1 pc.



Variant	Item no.
■ black	145560
□ white	1001516
■ grey	145564

L-connector, earth electrode exterior

16A max.
Plastic / Steel
L: 15 cm W: 15 cm H: 3.2 cm
Weight: 0.24 kg
1 pc.



Variant	Item no.
■ black	145670
□ white	1001520
■ grey	145674

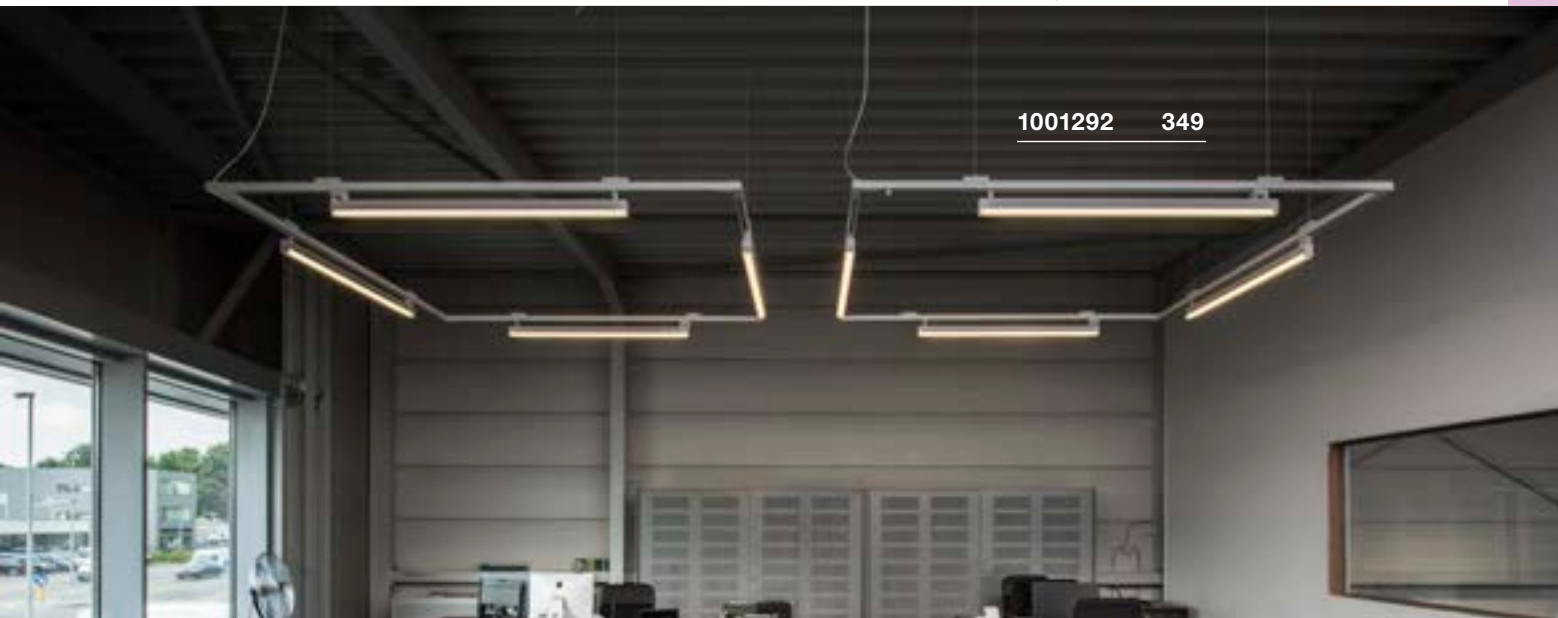

ACCESSORIES FOR EUTRAC® 3-CIRCUIT SURFACE MOUNTED TRACK

L-connector, earth electrode interior

16A max.
Plastic / Steel
L: 15 cm W: 15 cm H: 3.2 cm
Weight: 0.24 kg
1 pc.



Variant	Item no.
■ black	145680
□ white	1001521
■ grey	145684

Socket

6.3A max.
Plastic
L: 9.6 cm W: 6.5 cm H: 9 cm
Weight: 0.17 kg
1 pc.



Variant	Item no.
■ black	145700
□ white	1001525

Pendant suspension, rigid

Plastic / Steel
Ø: 7 cm L: 120 cm H: 122 cm
Weight: 0.49 kg
1 pc.



Variant	Item no.
■ black	145710
□ white	1001528
■ grey	145714

X-connector

16A max.
Plastic / Steel
L: 26 cm W: 26 cm H: 3.2 cm
Weight: 0.27 kg
1 pc.



Variant	Item no.
■ black	145690
□ white	1001522
■ grey	145694

Universal point outlet

16A max.
Plastic
Ø: 11.9 cm H: 3.1 cm
1 pc.



Variant	Item no.
□ white	1001526
■ grey	145834
■ black	145830

Pendant suspension, rigid

Plastic / Steel
Ø: 7 cm L: 60 cm H: 63.5 cm
Weight: 0.28 kg
1 pc.



Variant	Item no.
■ black	145720
□ white	1001529
■ grey	145724

Coupling joint connector

Plastic
L: 10 cm W: 3.6 cm H: 1.9 cm
Weight: 0.06 kg
1 pc.



Variant	Item no.
■ black	145600
□ white	1001523
■ grey	145604

End cap

Plastic
L: 3.6 cm W: 1.7 cm H: 3.2 cm
Weight: 0.01 kg
2 pcs.



Variant	Item no.
■ black	145590
□ white	1001527
■ grey	145594

Swinging clip

Aluminium
L: 5 cm W: 3.6 cm H: 1.9 cm
Weight: 0.04 kg
1 pc.



Variant	Item no.
■ black	145730
□ white	1001530
■ grey	145734

Flexible connector

16A max.
Plastic / Steel
L: 22 cm W: 3.6 cm H: 3.2 cm
Weight: 0.23 kg
1 pc.



Variant	Item no.
■ black	145580
□ white	1001524
■ grey	145584

Ceiling suspension

Stainless Steel / Brass
L: 500 cm
Weight: 0.2 kg
2 pcs.



Variant	Item no.
■ nickel	1002845

3-circuit pendant luminaire adapter

10A max.
Plastic
1 pc.



Variant	Item no.
■ black	145990
□ white	1001542
■ silver-grey	145994

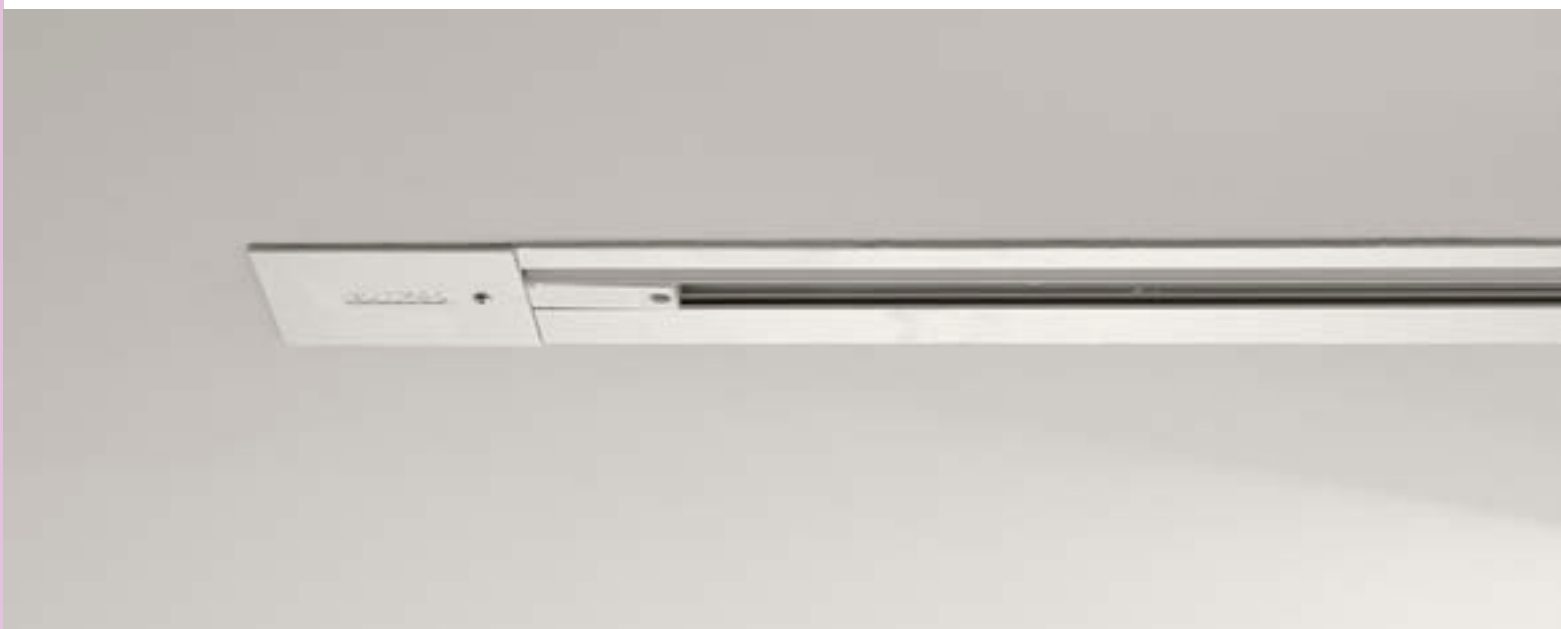

3-CIRCUIT RECESSED TRACK

Recessed track



	EUTRAC® 3-circuit recessed track, 2 m	EUTRAC® 3-circuit recessed track, 3 m
Rated voltage	230V ~50Hz	230V ~50Hz
Max. perm. current	16A	16A
Material	Aluminium / Plastic	Aluminium / Plastic
Colour	white	white
Length	200 cm	300 cm
Width	5.9 cm	5.9 cm
Height	4.1 cm	4.1 cm
Inst. Width	4 cm	4 cm
Weight	2.6 kg	3.9 kg
Item no.	1001531	1001532

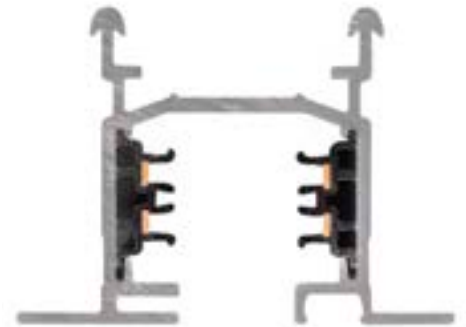

ACCESSORIES FOR 3-CIRCUIT RECESSED TRACK

Feed-in left

16A max.
Plastic / Steel
L: 12.2 cm W: 6 cm H: 3.4 cm
Weight: 0.1 kg
1 pc.



Variant	Item no.
<input type="checkbox"/> white	1001533

End cap

Plastic
L: 2.7 cm W: 6 cm H: 3.2 cm
Weight: 0.02 kg
1 pc.



Variant	Item no.
<input type="checkbox"/> white	1001538

Spring clip installation

Steel
L: 2 cm W: 1 cm H: 2.5 cm
Weight: 0.03 kg
6 pc.



Variant	Item no.
<input checked="" type="checkbox"/> grey	145551

Feed-in right

16A max.
Plastic / Steel
L: 12.2 cm W: 6 cm H: 3.4 cm
Weight: 0.1 kg
1 pc.



Variant	Item no.
<input type="checkbox"/> white	1001534

L-connector

16A max.
Plastic / Steel
L: 16 cm W: 16 cm H: 3.2 cm
Weight: 0.24 kg
Earth electrode inside with feed-in capability
1 pc.



Variant	Item no.
<input type="checkbox"/> white	1001537

Pendant adapter

10A max.
Plastic
Weight: 0.07 kg
1 pc.



Variant	Item no.
<input checked="" type="checkbox"/> black	145990
<input type="checkbox"/> white	1001542
<input checked="" type="checkbox"/> grey	145994

L-connector

16A max.
Plastic / Steel
L: 16 cm W: 16 cm H: 3.2 cm
Weight: 0.24 kg
Earth electrode exterior with feed-in capability
1 pc.



Variant	Item no.
<input type="checkbox"/> white	1001536

Long connector

16A max.
Plastic / Steel
L: 6.2 cm W: 2.5 cm H: 2.7 cm
Weight: 0.09 kg
1 pc.



Variant	Item no.
<input type="checkbox"/> white	1001539

KEEPING YOUR PROMISE.

2-CIRCUIT DESIGNER TRACK FOR SOPHISTICATED LIVING AMBIENCE.

When comfort and functionality converge, considerable demands are made of having the right product. The D-TRACK® 2-circuit designer track is therefore the perfect solution for anyone who would like to set visual highlights and make use of all of the light design possibilities.

140261 378

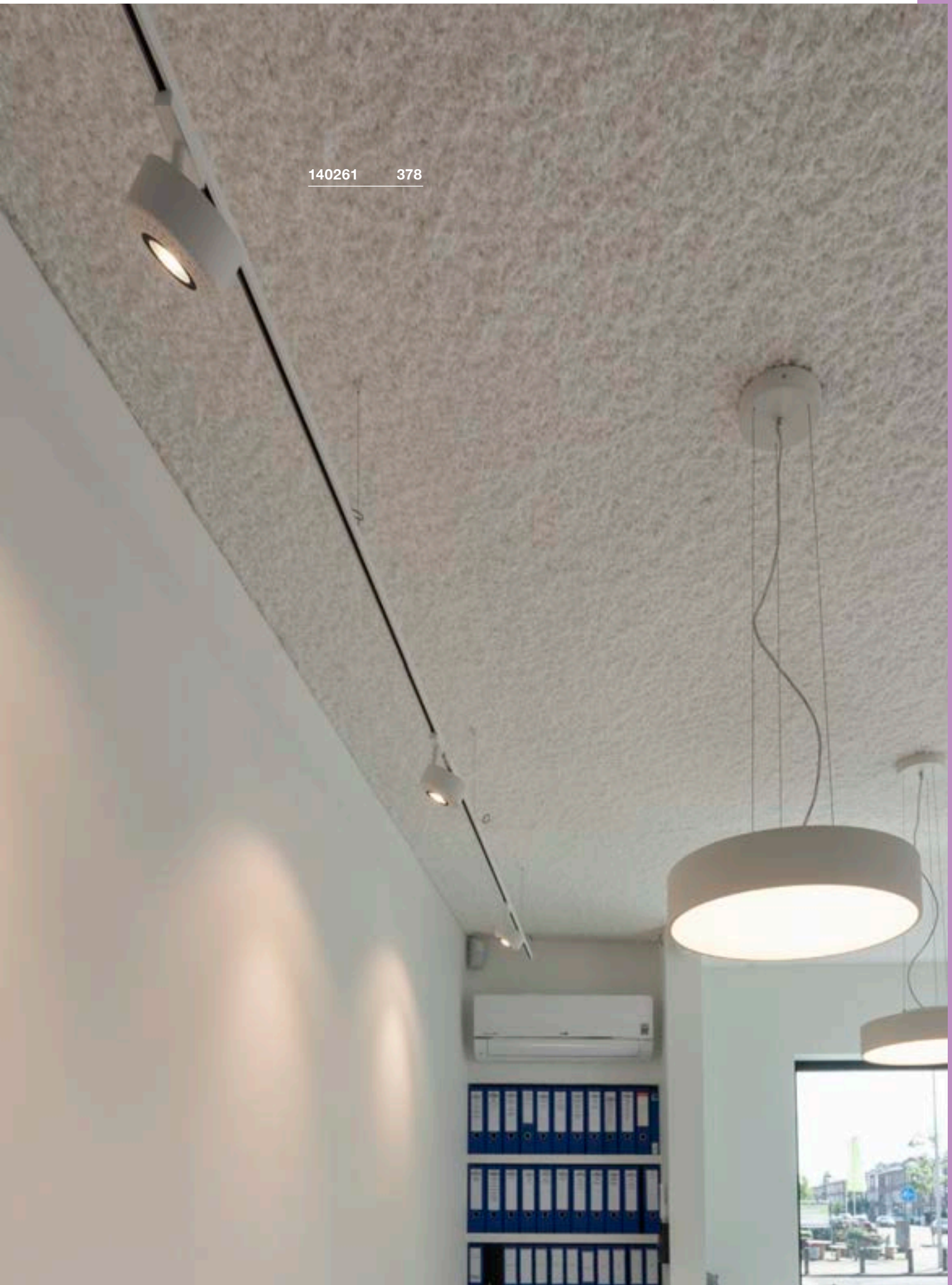



1001354 378

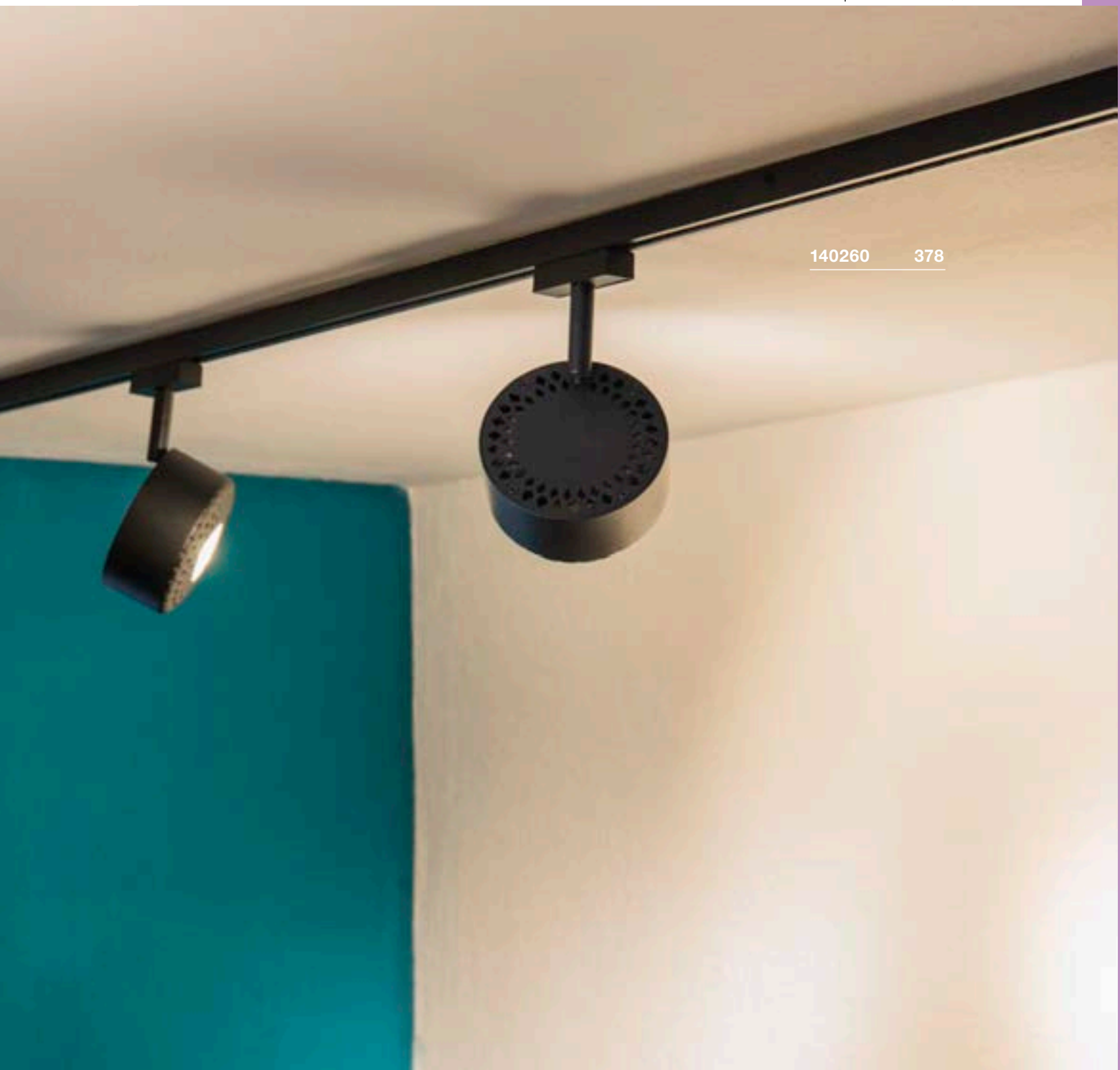

140260

378

240V TRACK D-TRACK®



Suitable track systems and accessories can be found on pages 380-381

 Other luminaires and variants can be found online at www.slv.com

REVILO TRACK
D-TRACK®



Product details

220-240V ~50/60Hz
Total consumption: 9.5W
Material: Aluminium / Steel

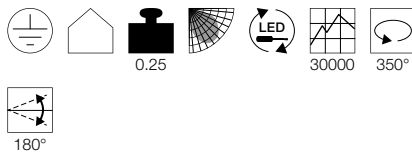

Dimensioned drawing

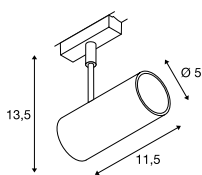

Recommended accessories

- Deco ring
Item no. 140240
- Deco ring
Item no. 140241
- Deco ring
Item no. 140243

Variant	Item no.
620lm 2700K CRI>80 15° ■ black	140200
620lm 2700K CRI>80 15° □ white	140201
620lm 2700K CRI>80 36° ■ black	140210
620lm 2700K CRI>80 36° □ white	140211

REVILO
D-TRACK®



Product details

220-240V ~50/60Hz
Total consumption: 9.5W
Material: Aluminium / Steel

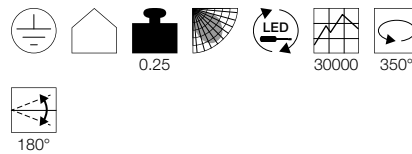

Dimensioned drawing

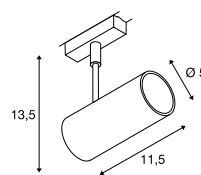

Recommended accessories

- Deco ring
Item no. 140240
- Deco ring
Item no. 140241
- Deco ring
Item no. 140243

Variant	Item no.
670lm 3000K CRI>80 15° ■ black	1001352
550lm 3000K CRI>80 15° □ white	140221
670lm 3000K CRI>80 36° ■ black	1001354
670lm 3000K CRI>80 36° □ white	1001355

TOTHEE
D-TRACK®, TRIAC



Product details

220-240V ~50/60Hz | 350mA
Total consumption: 17W
Material: Aluminium
Dimmable: Triac C, Triac L

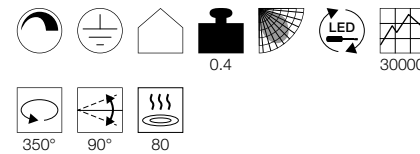

Dimensioned drawing

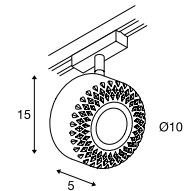

Recommended accessories

- Deco ring
Item no. 140240
- Deco ring
Item no. 140241
- Deco ring
Item no. 140243

Variant	Item no.
1250lm 3000K CRI>80 25° ■ black	140250
1250lm 3000K CRI>80 25° □ white	140251
1250lm 3000K CRI>80 50° ■ black	140260
1250lm 3000K CRI>80 50° □ white	140261



1001355 378



140250 378

D-TRACK®



Track, 1m



D-TRACK® 1m, 2-circuit surface-mounted track



D-TRACK® 1m, 2-circuit surface-mounted track

Rated voltage	230V, 50Hz, 60Hz	230V, 50Hz, 60Hz
Max. perm. current	10A	10A
Mech. max. load	100N	100N
Mech. max. load	10 kg	10 kg
Material	Aluminium / Plastic	Aluminium / Plastic
Colour	black	white
Length	100 cm	100 cm
Width	1.8 cm	1.8 cm
Height	1.8 cm	1.8 cm
Weight	0.4 kg	0.4 kg
Item no.	172010	172011

Note Max. 10A per phase. Max. 10A per phase.



Track, 2m



D-TRACK® 2m, 2-circuit surface-mounted track



D-TRACK® 2m, 2-circuit surface-mounted track

Rated voltage	230V, 50Hz, 60Hz	230V, 50Hz, 60Hz
Max. perm. current	10A	10A
Mech. max. load	200N	200N
Mech. max. load	20 kg	20 kg
Material	Aluminium / Plastic	Aluminium / Plastic
Colour	black	white
Length	200 cm	200 cm
Width	1.8 cm	1.8 cm
Height	1.8 cm	1.8 cm
Weight	0.8 kg	0.8 kg
Item no.	172020	172021

Note Max. 10A per phase. Max. 10A per phase.



Track, 3m



D-TRACK® 3m, 2-circuit surface-mounted track



D-TRACK® 3m, 2-circuit surface-mounted track

Rated voltage	230V, 50Hz, 60Hz	230V, 50Hz, 60Hz
max. power load	10A	10A
Mech. max. load	300N	300N
Mech. max. load	30 kg	30 kg
Material	Aluminium / Plastic	Aluminium / Plastic
Colour	black	white
Length	295 cm	295 cm
Width	1.8 cm	1.8 cm
Height	1.8 cm	1.8 cm
Weight	1.2 kg	1.2 kg
Item no.	172030	172031

Note Max. 10A per phase. Max. 10A per phase.

D-TRACK® PLANNING AID

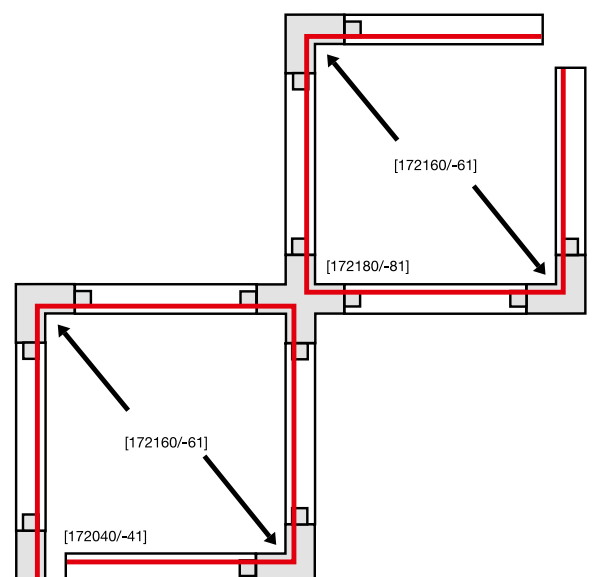
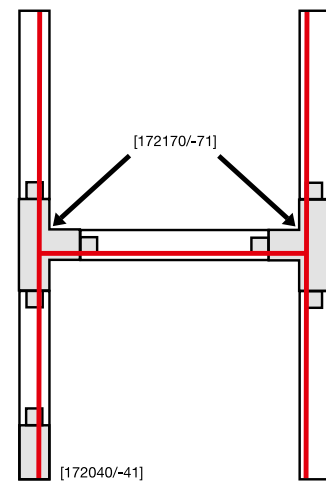
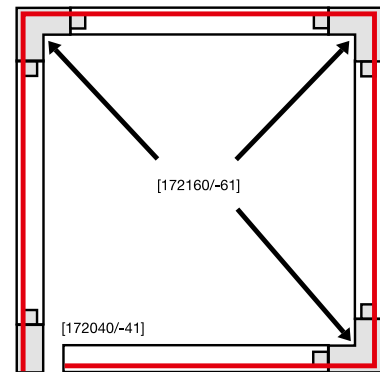
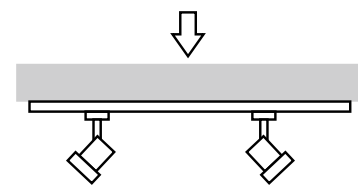

D-TRACK® ACCESSORIES

End infeed

10A max.
Aluminium / Steel
L: 22 cm W: 1.8 cm H: 1.8 cm
Weight: 0.09 kg
1 pc.



Variant	Item no.
■ black	172040
□ white	172041

End infeed

10A max.
Aluminium / Plastic
L: 9.4 cm W: 1.8 cm H: 1.8 cm
Weight: 0.42 kg
1 pc.



Variant	Item no.
■ black	172090
□ white	172091

Insulating connector

Steel / Plastic
L: 7 cm W: 1.5 cm H: 1.5 cm
Weight: 0.03 kg
1 pc.



Variant	Item no.
□ transparent	172145

Centre feed-in

10A max.
Aluminium / Steel
L: 37.5 cm W: 1.8 cm H: 1.8 cm
Weight: 0.26 kg
1 pc.



Variant	Item no.
■ black	172050
□ white	172051

Centre feed-in

10A max.
Aluminium / Plastic
L: 15.7 cm W: 1.8 cm H: 1.8 cm
Weight: 0.39 kg
1 pc.



Variant	Item no.
■ black	172100
□ white	172101

Flexible connector

10A max.
Aluminium / Plastic
L: 29 cm W: 1.8 cm H: 1.8 cm
Weight: 0.12 kg
13.5 cm cable length.
1 pc.



Variant	Item no.
■ black	172190
□ white	172191

End infeed

10A max.
Aluminium / Steel
L: 11.7 cm W: 8 cm H: 4 cm
Weight: 0.38 kg
1 pc.



Variant	Item no.
■ black	172060
□ white	172061

End cap

Plastic
L: 1.1 cm W: 1.8 cm H: 1.8 cm
Weight: 0.01 kg
1 pc.



Variant	Item no.
■ black	172110
□ white	172111

Steel wire holders

Aluminium / Steel
L: 100 cm
Weight: 0.02 kg
1 pc.



Variant	Item no.
■ black	172200
□ white	172201

Centre feed-in

10A max.
Aluminium / Steel
L: 15.5 cm W: 8 cm H: 4 cm
Weight: 0.26 kg
1 pc.



Variant	Item no.
■ black	172070
□ white	172071

Aluminium cover

Aluminium / Plastic
L: 100 cm W: 1.8 cm H: 0.2 cm
Weight: 0.06 kg
Incl. 10 fastening clips.
1 pc.



Variant	Item no.
■ black	172120
□ white	172121

Adapter

2A max.
Aluminium / Plastic
L: 7 cm W: 1.9 cm H: 3.2 cm
Weight: 0.05 kg
Incl. strain relief for pendants.
Suitable for products with M10 thread.
1 pc.



Variant	Item no.
■ black	172220
□ white	172221

End infeed

10A max.
Aluminium / Plastic
L: 9.4 cm W: 1.8 cm H: 1.8 cm
Weight: 0.25 kg
Incl. connection box with strain relief
1 pc.



Variant	Item no.
■ black	172080
□ white	172081

Linear connector

10A max.
Steel / Plastic
L: 7 cm W: 1.5 cm H: 1.5 cm
Weight: 0.03 kg
1 pc.



Variant	Item no.
■ grey	172134

STAYING ON TRACK.

SIMPLY WELL ILLUMINATED WITH 1-PHASE
240VTRACKS.

Thanks to the holes in the profile, the flat aluminium track can be attached to the wall or ceiling in a quick and uncomplicated way. When doing this you have the choice between a recessed version and a surface-mounted version, available in several colours.

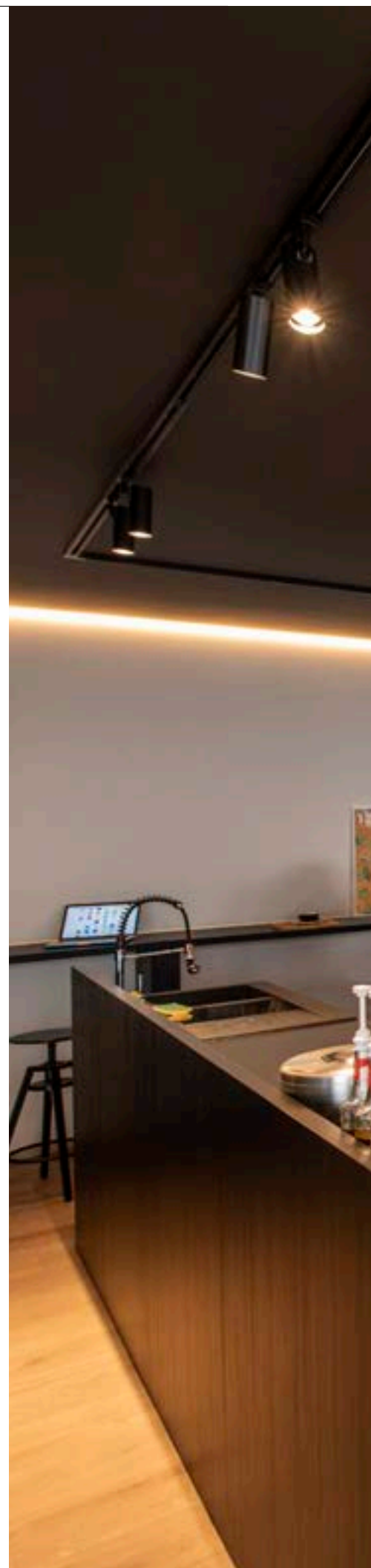

143580 397



1001862 396





1001868 387

240V TRACK, 1-CIRCUIT



Suitable recessed and surface mounted track systems as well as accessories can be found on pages 402-405

 Other luminaires and variants can be found online at www.slv.com

NOBLO SPOT
1 circuit, Triple Track Set



A-A++ Range A++-E

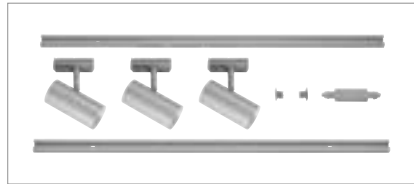

PURI TRACK
1 circuit, Triple Track Set



E-A++ Range A++-E

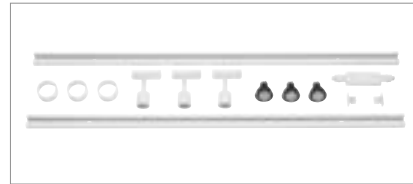

Product details

220-240V ~50/60Hz | 350mA
Total consumption: 22.5W
Material: Aluminium

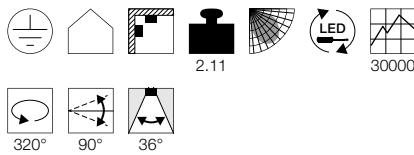

Note

The set consists of:
2x 1m 240V tracks [143010/-1/-2]
1x feed-in cable/longitudinal connector [143100/-1/-2]
1x 2 end caps [143130/-1/-2]
3x lamp heads NOBLO [1001862/-3/-4]

Product details

230V ~50Hz
Total consumption: 12.9W
Material: Aluminium

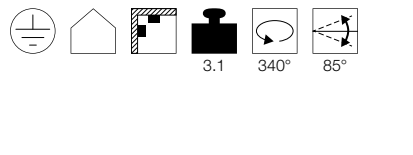

Note

The set consists of:
2x 1m 240V tracks
1x long connector
1x 2 end caps
3x lamp heads PURI
3x LED GU10 lamps
3x deco rings for GU10

Lamp details

3x 4.3W LEDs GU10 51mm

Variant	Item no.
1860lm 2700K CRI>80	
■ black	1002610
1860lm 2700K CRI>80	
□ white	1002611
1860lm 2700K CRI>80	
■ grey	1002612

Variant	Item no.
GU10 LED GU10 51mm	
■ black	143190
GU10 LED GU10 51mm	
□ white	143191
GU10 LED GU10 51mm	
■ grey	143194

1002611 387



144201 387

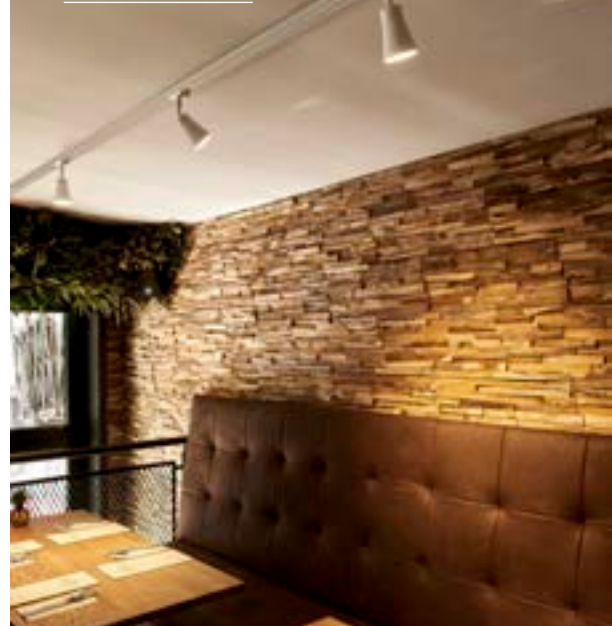

1001868 387





PURIA TRACK
1-circuit, QPAR51

E-A++ Range A++-E

Icons: Home with +, Black, White, Grey



Product details

230V ~50Hz
Material: Aluminium / Glass



Dimensioned drawing

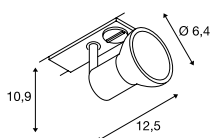

Recommended lamp

LED GU10 5.5W 38°
3000K 440lm EEL=A+
6kWh/1000h
Item no. 551902



LED GU10 7W 25/40/55°
3000K 300lm EEL=A
7kWh/1000h
Item no. 560603



Lamp details

max. 10W QPAR51

Variant	Item no.
GU10 QPAR51	
■ matt black	143450
GU10 QPAR51	
□ white/matt transparent	143451
GU10 QPAR51	
■ grey	143454

AVO TRACK
1-circuit, QPAR51

E-A++ Range A++-E

Icons: Home with +, Black, White, Grey, 884

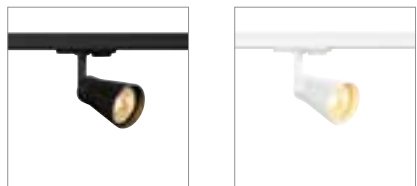

Product details

230V ~50/60Hz
Material: Steel



Dimensioned drawing

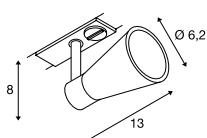

Recommended lamp

LED GU10 7.2W 36°
3000K 520lm EEL=A+
8kWh/1000h
Item no. 1001563



LED GU10 5.5W 38°
2700K 400lm EEL=A+
6kWh/1000h
Item no. 1001030



Lamp details

max. 50W QPAR51
Ø: 5 cm max.

Variant	Item no.
GU10 QPAR51	
■ black	144200
GU10 QPAR51	
□ white	144201
GU10 QPAR51	
■ grey	144204

PURI TRACK
1-circuit, QPAR51

E-A++ Range A++-E

Icons: Home with +, Black, White, Grey, 894

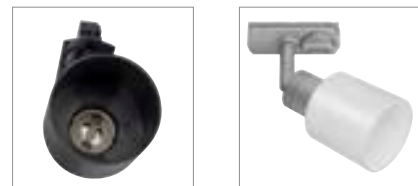

Product details

230V ~50Hz
Material: Aluminium / Plastic

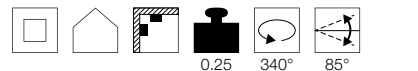

Dimensioned drawing

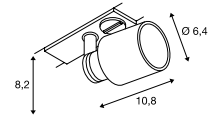

Recommended lamp

LED GU10 5.5W 38°
2700K 400lm EEL=A+
6kWh/1000h
Item no. 1001030



LED GU10 7.2W 36°
3000K 520lm EEL=A+
8kWh/1000h
Item no. 1001562



Lamp details

max. 10W QPAR51

Variant	Item no.
GU10 QPAR51	
■ black	1001868
GU10 QPAR51	
□ white	1001869
GU10 QPAR51	
■ grey	1001870

PURI TRACK
1-circuit, QPAR51



E-A++ Range A++-E



SPOT TRACK
1-circuit, E27



D-A+ Range A++-E



LIGHT EYE® 90
1-circuit, QPAR51



E-A++ Range A++-E

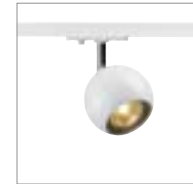

- The optional deco ring for the lamp in the appropriate colour reduces the distance between the housing and the lamp

Product details

230V ~50Hz
Material: Aluminium / Polycarbonate (PC)



Product details

230V ~50Hz
Material: Aluminium

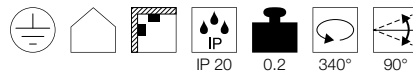

Product details

230V ~50/60Hz
Material: Steel

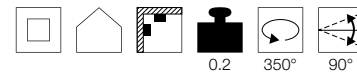

Dimensioned drawing

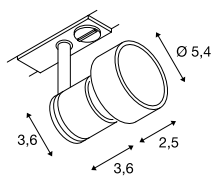

Dimensioned drawing

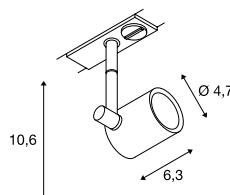

Dimensioned drawing

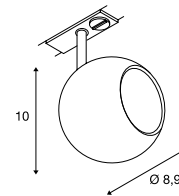

Recommended lamp

LED GU10 7.2W 36°
4000K 540lm EEL=A+
8kWh/1000h
Item no. 1001565



LED GU10 7.2W 36°
2700K 520lm EEL=A+
8kWh/1000h
Item no. 1001560



Lamp details

max. 50W QPAR51

Variant	Item no.
GU10 QPAR51	
■ matt black	143390
GU10 QPAR51	
□ white	143391
GU10 QPAR51	
■ grey	143392

Recommended lamp

LED E27 11.5W 38°
3000K 760lm EEL=A+
12kWh/1000h
Item no. 551933



LED E27 17W 45°
3000K 1430lm EEL=A+
17kWh/1000h
Item no. 560473



Lamp details

max. 75W QPAR20
optional: QPAR30

Variant	Item no.
E27 QPAR20	
■ black	1001874
E27 QPAR20	
□ white	1001875
E27 QPAR20	
■ grey	1001876

Recommended accessories

- Lamp deco ring diam. 5.7cm
Item no. 151040
- Lamp deco ring diam. 5.7cm
Item no. 151041
- Lamp deco ring diam. 5.7cm
Item no. 151049



Recommended lamp

LED GU10 5.5W 36°
2700K 400lm EEL=A+
6kWh/1000h
Item no. 1001030



LED GU10 7.2W 36°
2700K 520lm EEL=A+
8kWh/1000h
Item no. 1001560



Lamp details

max. 50W QPAR51

Variant	Item no.
GU10 QPAR51	
■ white / chrome	144011
GU10 QPAR51	
■ gold	144013
GU10 QPAR51	
■ copper	144019
GU10 QPAR51	
■ black / chrome	144010

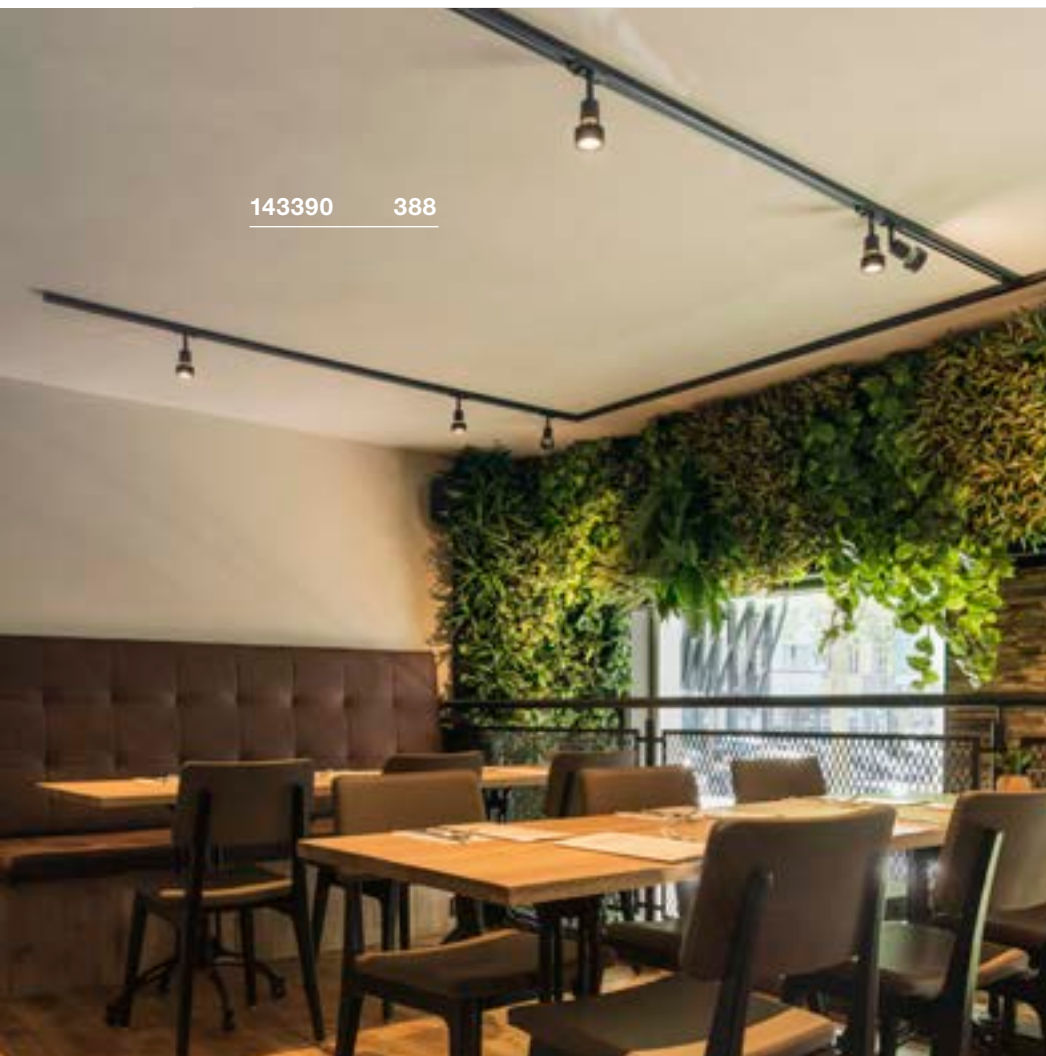

143390 388

PARA CONE 14

1-circuit, QPAR51

 893

E-A++ Range
A++-E



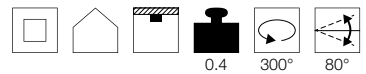

Product details

220-240V ~50/60Hz
Material: Steel



0.4 300° 80°

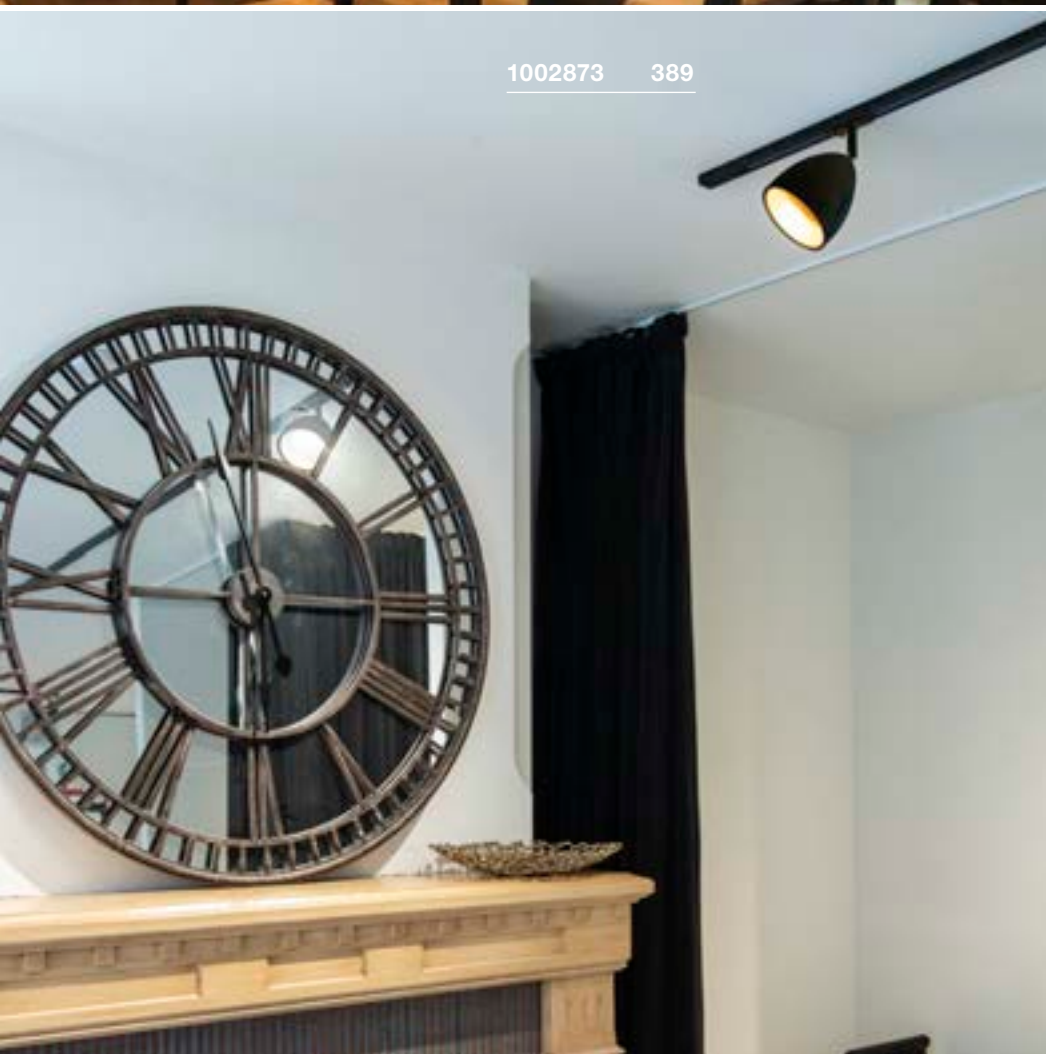
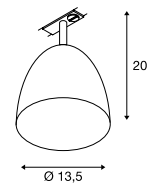

Dimensioned drawing



1002873 389

Lamp details

max. 25W QPAR51

Variant	Item no.
GU10	
■ shiny black	1002873 
GU10	
□ shiny white	1002874 
GU10	
■ copper	1002875 

ENOLA B TRACK
1-circuit, QPAR51



E-A++ Range
A++-E



1002113 390

Product details

230V ~50/60Hz
Material: Aluminium / Steel

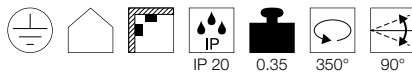

Dimensioned drawing

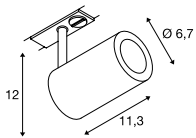

Recommended lamp

LED GU10 5.5W 38°
2700K 400lm EEL=A+
6kWh/1000h
Item no. 1001030



LED GU10 7.2W 36°
3000K 520lm EEL=A+
8kWh/1000h
Item no. 1001562



Lamp details

max. 50W QPAR51
Ø: 5 cm max. L: 6.7 cm max.

Variant	Item no.
GU10 QPAR51	
■ black	1002110
GU10 QPAR51	
□ white	1002111
GU10 QPAR51	
■ grey	1002113





143440 391



143430 391

BIMA
1-circuit, single, QPAR51



E-A++ Range A++-E



BIMA
1-circuit, double, QPAR51



E-A++ Range A++-E



Product details

220-240V ~50/60Hz
Material: Aluminium

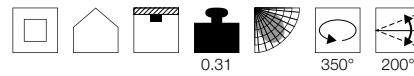

0.31 350° 200°

Product details

220-240V ~50/60Hz
Material: Aluminium



0.51 350° 200°

Dimensioned drawing

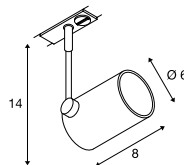

Dimensioned drawing

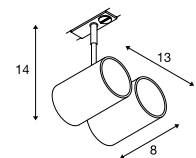

Recommended lamp

LED GU10 7.2W 36°
3000K 520lm EEL=A+
8kWh/1000h
Item no. 1001563



LED GU10 5.5W 38°
2700K 400lm EEL=A+
6kWh/1000h
Item no. 1001030



Recommended lamp

LED GU10 7.2W 36°
3000K 520lm EEL=A+
8kWh/1000h
Item no. 1001563



LED GU10 7.2W 36°
4000K 540lm EEL=A+
8kWh/1000h
Item no. 1001566



Lamp details

max. 50W QPAR51
Ø: 5 cm max. L: 5.7 cm max.

Lamp details

2x max. 50W QPAR51
Ø: 5 cm max. L: 5.7 cm max.

Variant	Item no.
GU10 QPAR51	
■ matt black	143440
□ matt white	143441
■ grey	143442

Variant	Item no.
GU10 QPAR51	
■ matt black	143430
□ matt white	143431
■ grey	143432

EURO SPOT TRACK
1-circuit QPAR51



E-A++ Range A++-E



EURO SPOT TRACK
1-circuit



A-A++ Range A++-E



Product details

230V ~50Hz
Material: Aluminium / Glass



0.47

350°

90°

Dimensioned drawing

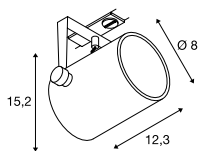

Product details

230V ~50Hz
Total consumption: 11W
Material: Aluminium



0.65

3000K

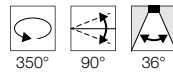

350°

90°

36°

Dimensioned drawing

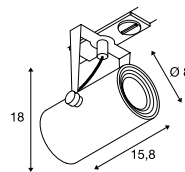

Recommended lamp

LED GU10 5.5W 38°
2700K 400lm EEL=A+
6kWh/1000h

Item no. 1001030



LED GU10 5.1W 48°
2700-6500K 350lm EEL=A+
6kWh/1000h

Item no. 1001918



Lamp details

max. 25W QPAR51

Variant	Item no.
GU10 QPAR51	
■ black	1001861
GU10 QPAR51	
□ white / transparent	143811
GU10 QPAR51	
■ grey	143814

Variant	Item no.
650lm 3000K CRI>80	
■ black	1001485
650lm 3000K CRI>80	
□ white	1001486
650lm 3000K CRI>80	
■ grey	1001487



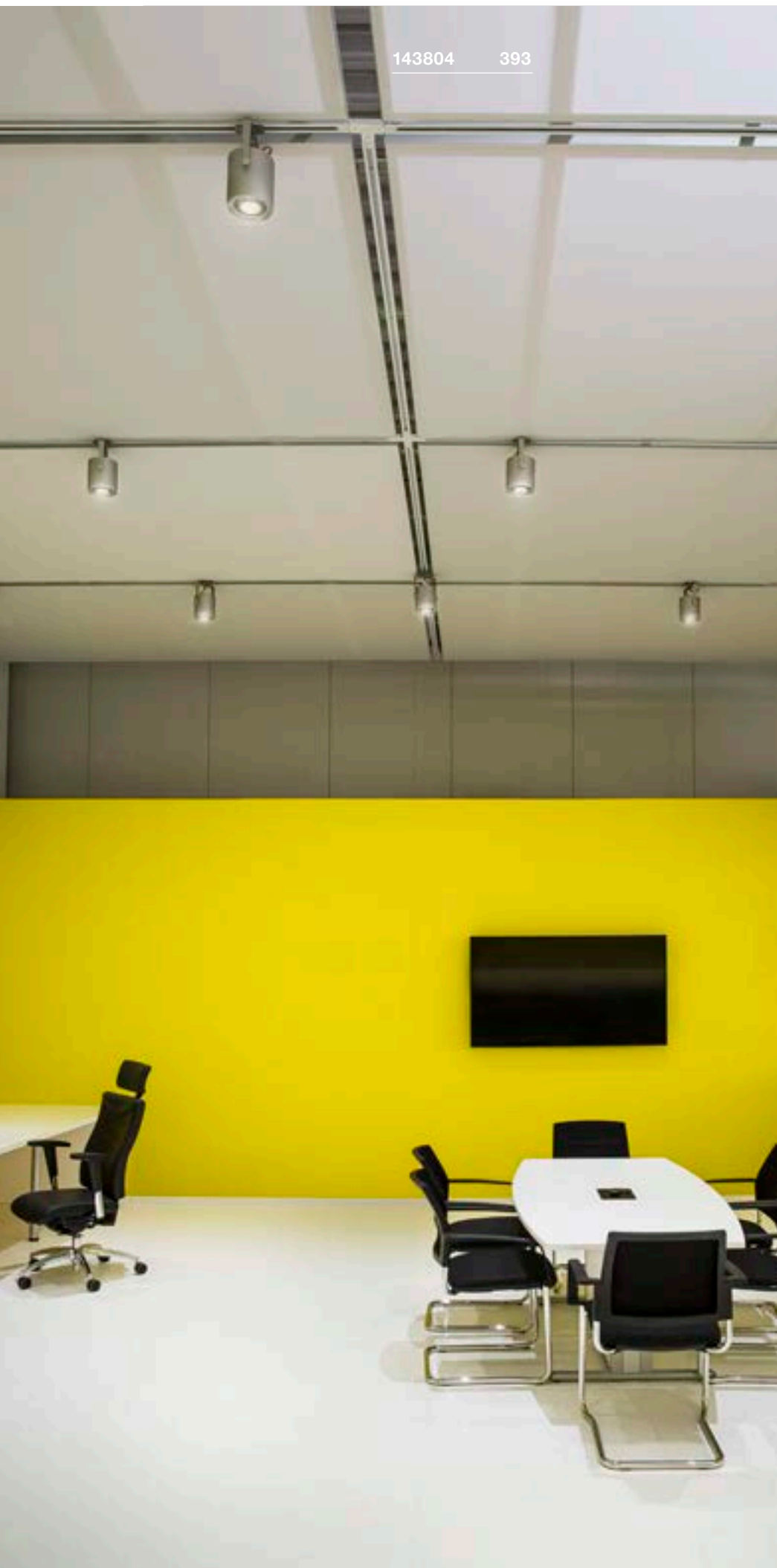

143804 393

EURO SPOT TRACK

1-circuit QPAR111

886

E-A++ Range A++-E



Product details

230V ~50Hz
Material: Aluminium



0.83

350°

90°

Dimensioned drawing

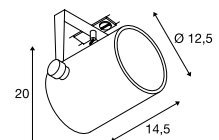

Recommended lamp

GU10 7W 13°
3000K 660lm EEL=A+
8kWh/1000h

Item no. 1001568

LED GU10 13W 30°
2700K 1100lm EEL=A+
13kWh/1000h

Item no. 1001242



Lamp details

max. 75W QPAR111

Variant	Item no.
GU10 QPAR111	
■ black	1001860
□ white	143801
■ grey	143804

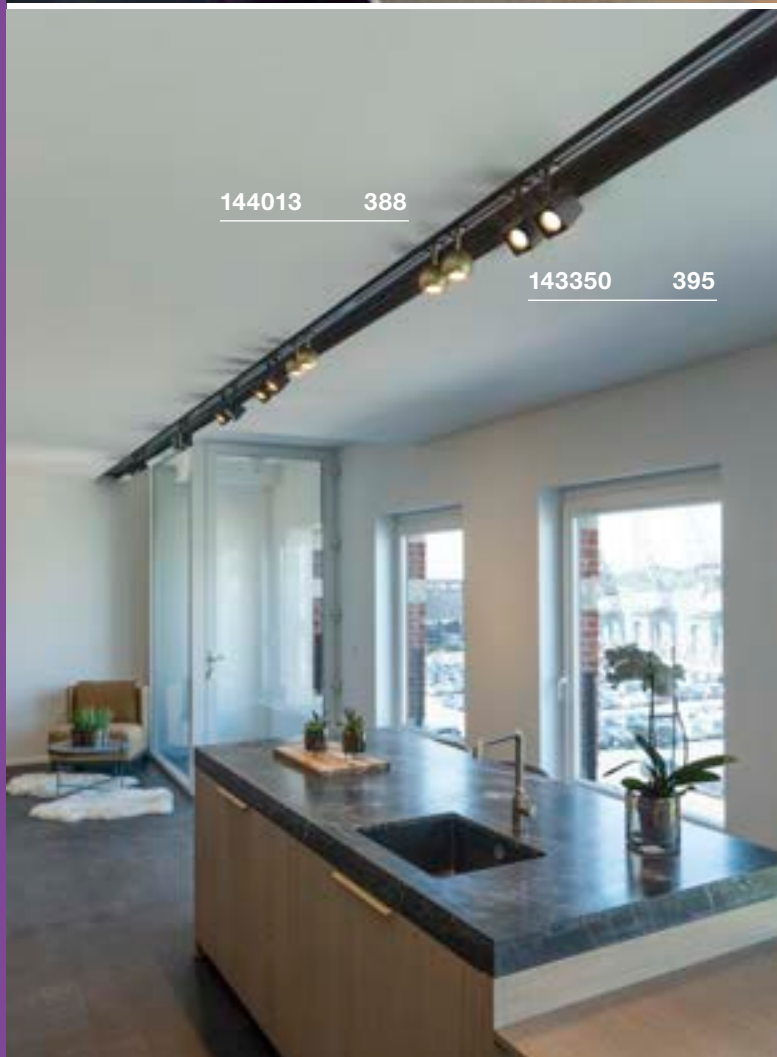
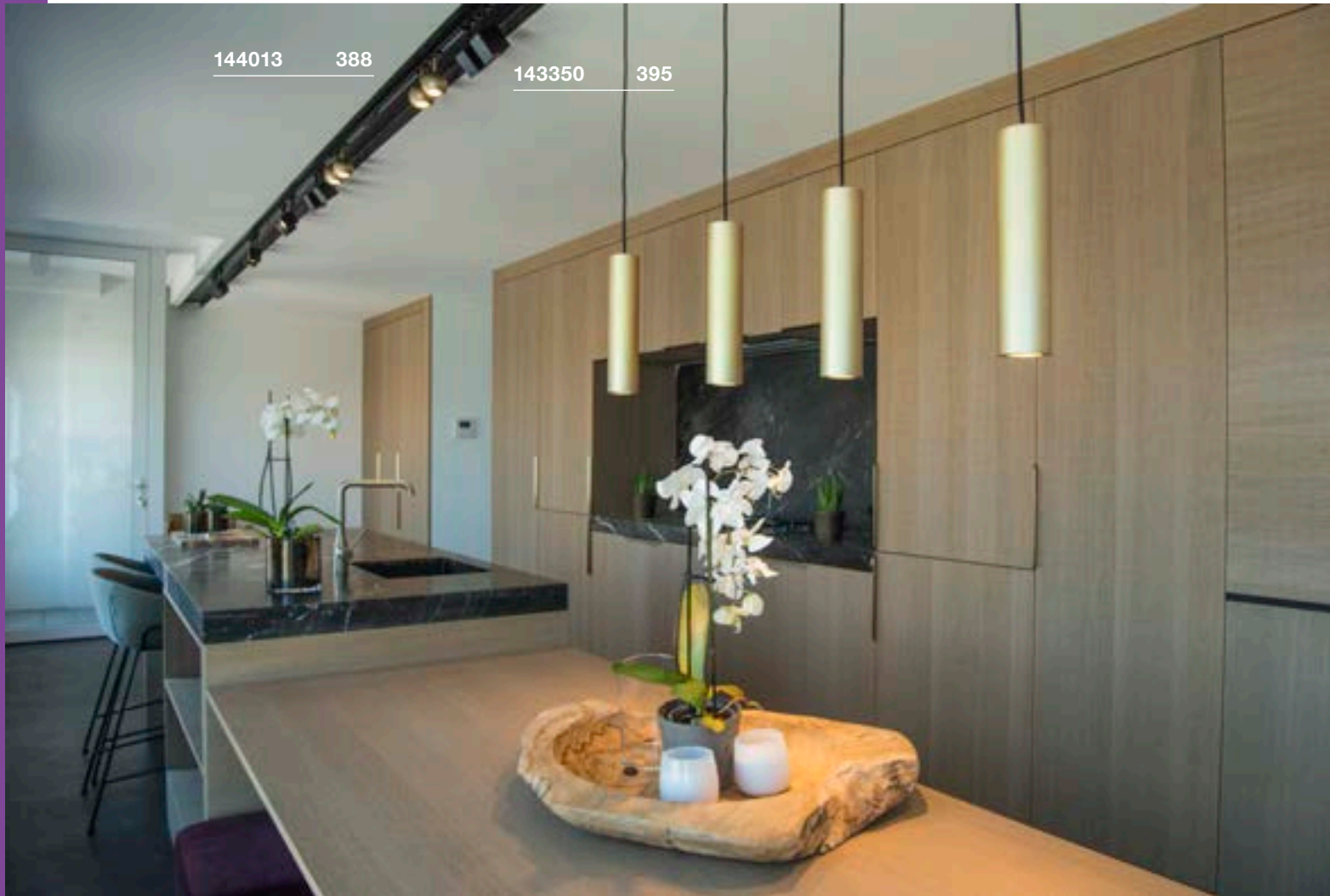

ALTRA DICE TRACK
1-circuit, QPAR51



E-A++ Range A++-E



Product details

230V ~50/60Hz
Material: Aluminium



Dimensioned drawing

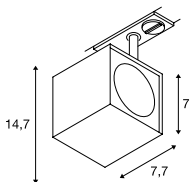

Recommended lamp

LED GU10 7.2W 36°
3000K 520lm EEL=A+
8kWh/1000h
Item no. 1001563



LED GU10 5.5W 38°
2700K 400lm EEL=A+
6kWh/1000h
Item no. 1001030



Lamp details

max. 50W QPAR51

Variant	Item no.
GU10 QPAR51	
■ black	143350
GU10 QPAR51	
□ white	143351
GU10 QPAR51	
■ grey	143354

KALU TRACK
1-circuit, TRIAC



A-A++ Range A++-E

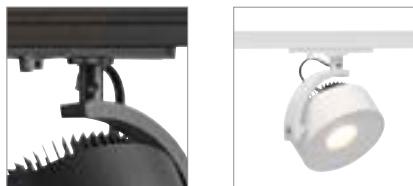

Product details

220-240V ~50/60Hz
Total consumption: 13W
Material: Aluminium
Dimmable: Triac C

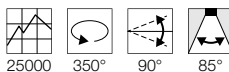
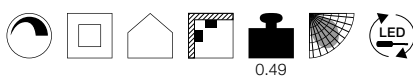

Dimensioned drawing

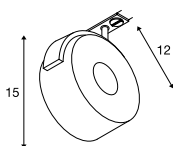

Recommended lamp

LED GU10 7.2W 36°
3000K 520lm EEL=A+
8kWh/1000h
Item no. 1001563



LED GU10 5.5W 38°
2700K 400lm EEL=A+
6kWh/1000h
Item no. 1001030



Lamp details

max. 50W QPAR51

Variant	Item no.
860lm 3000K CRI>80	
■ black	1002854
860lm 3000K CRI>80	
□ white	143731

KALU TRACK
1-circuit, QPAR111



E-A++ Range A++-E

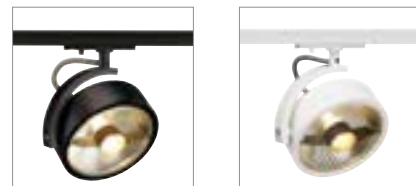

Product details

230V ~50Hz
Material: Aluminium / Plastic



Dimensioned drawing

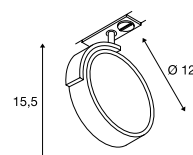

Recommended lamp

GU10 7.9W 25°
4000K 760lm EEL=A+
8kWh/1000h
Item no. 560704



LED GU10 13W 30°
4000K 1300lm EEL=A+
13kWh/1000h
Item no. 1001243



Lamp details

max. 75W QPAR111

Variant	Item no.
GU10 QPAR111	
■ matt black	143540
GU10 QPAR111	
□ white	143541
GU10 QPAR111	
■ grey	143544

NOBLO SPOT
1-circuit



A-A++ Range
A++-E



Product details

220-240V ~50/60Hz | 350mA
Total consumption: 7.5W
Material: Aluminium

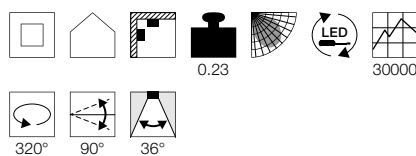

Dimensioned drawing

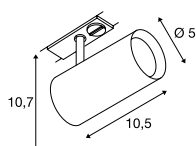

1001863 396



Variant	Item no.
620lm 2700K CRI>80	
■ black	1001862
620lm 2700K CRI>80	
□ white	1001863
620lm 2700K CRI>80	
■ grey	1001864



143580 397



1000712 397

HELIA 50 TRACK 1-circuit



A-A++ Range A++-E



- Premium LED with CRI>90

Product details

220-240V ~50/60Hz | 500mA
Total consumption: 11W
Material: Aluminium

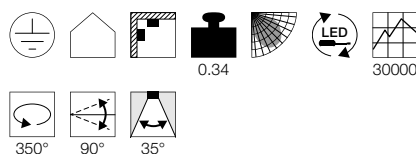

Dimensioned drawing

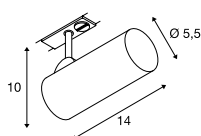

Variant	Item no.
750lm 3000K CRI>90	
■ black	143580
750lm 3000K CRI>90	
□ white	143581

ENOLA C TRACK 1-circuit



A-A++ Range A++-E

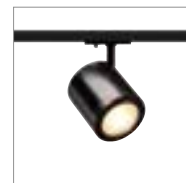

Product details

220-240V ~50/60Hz | 500mA
Total consumption: 11W
Material: Aluminium / Glass

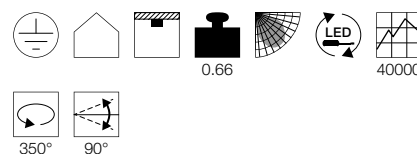

Dimensioned drawing

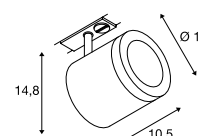

Variant	Item no.
900lm 3000K CRI>80 35°	
■ black	1000711
900lm 3000K CRI>80 35°	
□ white / transparent	143941
900lm 3000K CRI>80 55°	
■ black	1000712
900lm 3000K CRI>80 55°	
□ white	143951

STRUCTEC
1-circuit



A-A++ Range A++-E

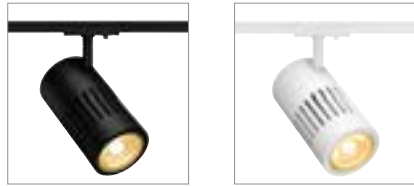

- Premium LED with CRI>90

Product details

230V ~50/60Hz
Total consumption: 28W
Material: Aluminium

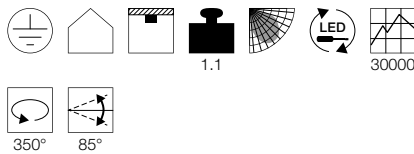

Dimensioned drawing

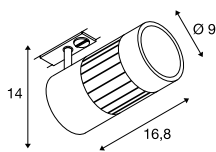

Variant	Item no.
2700lm 3000K CRI>90 36° ■ black	1000974
2700lm 3000K CRI>90 36° □ white	1000975
2700lm 3000K CRI>90 36° ■ grey	1000976
2650lm 3000K CRI>90 60° ■ black	1000977
2650lm 3000K CRI>90 60° □ white	1000978
2650lm 3000K CRI>90 60° ■ grey	1000979

BILAS TRACK
1-circuit, TRIAC



A-A++ Range A++-E



- 240V LED

Product details

230V ~50/60Hz
Total consumption: 16W
Material: Aluminium / Glass
Dimmable: Triac C, Triac L

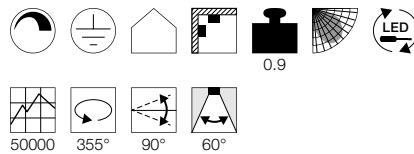

Dimensioned drawing

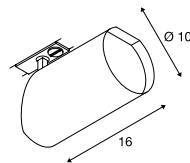

Variant	Item no.
1000lm 2700K CRI>80 ■ matt black	143560
1000lm 2700K CRI>80 □ matt white	143561



1000978 398



143561 398

DESIGNED BY
Vincent de Smedt



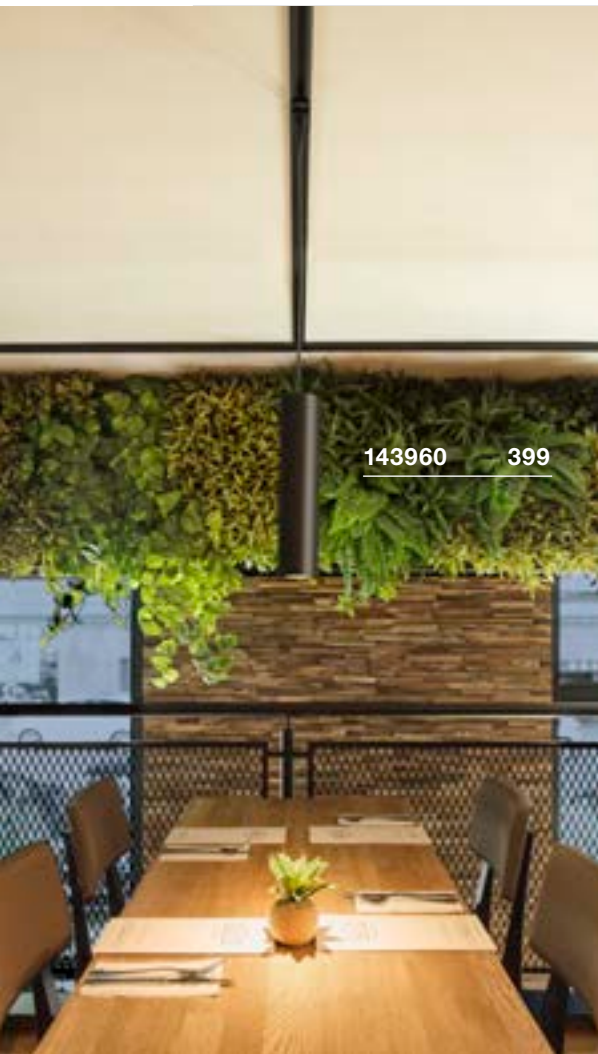

143960 399



1000713 399

ENOLA B
PD, QPAR51



E-A++ Range A++-E



Product details

230V ~50Hz
Material: Aluminium / Steel

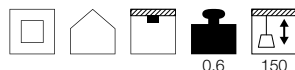

Dimensioned drawing

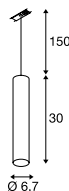

LIGHT EYE® 150
PD, QPAR111



E-A++ Range A++-E



Product details

230V ~50Hz
Material: Steel

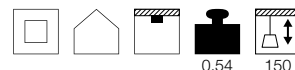

Dimensioned drawing

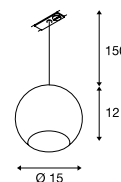

Recommended accessories

- Ceiling hook
Item no. 132670
- Ceiling hook
Item no. 132671
- Cable hook
Item no. 132680
- Cable hook
Item no. 132681

Recommended lamp

- LED GU10 7.2W 36°
3000K 520lm EEL=A+
8kWh/1000h
Item no. 1001563
- LED GU10 7W 25/40/55°
3000K 300lm EEL=A
7kWh/1000h
Item no. 560603

Lamp details

max. 50W QPAR51

Variant	Item no.
GU10 QPAR51	
<input checked="" type="checkbox"/> black	143960
GU10 QPAR51	
<input type="checkbox"/> white	143961
GU10 QPAR51	
<input checked="" type="checkbox"/> grey	143964

Recommended lamp

- LED GU10 13W 30°
2700K 1100lm EEL=A+
13kWh/1000h
Item no. 1001242
- LED GU10 13W 140°
2700K 1000lm EEL=A+
13kWh/1000h
Item no. 1001244

Lamp details

max. 75W QPAR111

Variant	Item no.
GU10 QPAR111	
<input checked="" type="checkbox"/> black / chrome	1000713
GU10 QPAR111	
<input checked="" type="checkbox"/> chrome	143620
GU10 QPAR111	
<input checked="" type="checkbox"/> white / chrome	143621

PARA CONE 14
1-circuit, PD, QPAR51



E-A++ Range A++-E

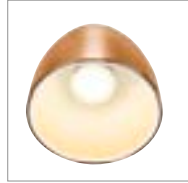

- Can be combined into a "lighting group" by means of individual configuration

Product details

230V ~50Hz
Material: Aluminium

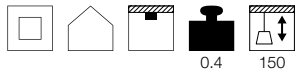

Dimensioned drawing

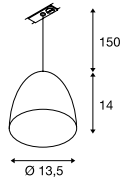

Recommended lamp

LED GU10 7.2W 36°
3000K 520lm EEL=A+
8kWh/1000h
Item no. 1001563



LED GU10 5.5W 38°
2700K 400lm EEL=A+
6kWh/1000h
Item no. 1001030



Lamp details

max. 35W QPAR51

Variant	Item no.
GU10 QPAR51	
■ shiny black	143990
GU10 QPAR51	
□ white	143991
GU10 QPAR51	
■ copper	1001968

TONGA®
1-circuit. PD, E14



E-A++ Range A++-E



- Ceramic shade

Product details

220-240V ~50/60Hz
Material: Aluminium / Glass

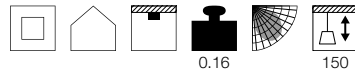

Dimensioned drawing

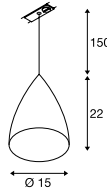

Recommended lamp

E14 3.4W 260°
3000K 250lm EEL=A+
4kWh/1000h
Item no. 560362



LED E14 6.5W 280°
3000K 480lm EEL=A+
7kWh/1000h
Item no. 560372



Lamp details

max. 60W C35
Ø: 5 cm max. L: 13 cm max.

Variant	Item no.
E14 C35	
■ grey / shiny opaque	143594

1001968 400



143594 400





FORCHINI M 40 TRACK
1-circuit, E27



E-A++ Range A++-E

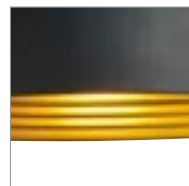

- Textured interior design with internal reflector
- Textile cable in housing colour

Product details

230V ~50Hz
Material: Aluminium / Steel

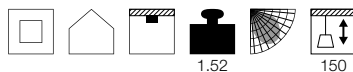

Dimensioned drawing

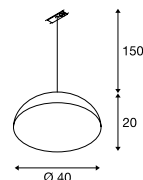

Note

Pendant adapter colour silver-grey [143930] / white [143931] / black [143932]

Recommended lamp

LED E27 7W 330°
2700K 806lm EEL=A+
8kWh/1000h
Item no. 1001035



LED E27 7W 280°
2200-2700K 830lm EEL=A++
7kWh/1000h
Item no. 1002126



Lamp details

max. 40W A60
Ø: 6.8 cm max. L: 15.2 cm max.

Variant	Item no.
E27 A60 ■ black / gold	143930
E27 A60 ■ white/gold	143931
E27 A60 ■ black / gold	143932



RECESSED TRACK 2 M

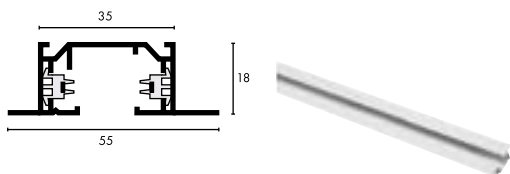

1-CIRCUIT RECESSED TRACK



Rated voltage	230V, 50Hz, 60Hz
Max. perm. current	16A
Feed-in capability	no
Material	Aluminium
Colour	white
Length	200 cm
Width	5.5 cm
Height	1.8 cm
Installation width	4 cm
Weight	1.16 kg

Item no.	143221
-----------------	---------------



Ceiling suspension

Stainless steel / brass
L: 500 cm
Weight: 0.2 kg
2 pc.

Variant	Item no.
■ Nickel	1002845

Corner connector, earth on outside

16A max.
Plastic
L: 11.2 cm W: 11.2 cm H: 2 cm
Weight: 0.07 kg
External earth electrode
1 pc.

Variant	Item no.
□ white	143251

Cover

Plastic
L: 100 cm W: 1.8 cm
Weight: 0.04 kg
1 pc.

Variant	Item no.
□ white	143291

Retaining bracket

Steel
L: 7.5 cm W: 1.5 cm H: 4 cm
Weight: 0.03 kg
Required for reinforcement when installing several tracks of the long connector including stabiliser (143271)
Optional for reinforcement for corner installation of the corner connector stabiliser, long (143152), 1 pc.

Variant	Item no.
■ matt nickel	143230

Corner connector, earth on inside

16A max.
Plastic
L: 11.2 cm W: 11.2 cm H: 2 cm
Weight: 0.07 kg
Internal earth
1 pc.

Variant	Item no.
□ white	143261

Stabiliser, long corner connector

Steel
L: 11.5 cm W: 11.5 cm H: 0.5 cm
Weight: 0.06 kg
For reinforcement when mounting several tracks with ceiling suspension (143140/-1/-2)
1 pc.

Variant	Item no.
■ matt nickel	143152

Feed-in, earth on left side

16A max.
Plastic
L: 10.8 cm W: 5.5 cm H: 2 cm
Weight: 0.41 kg
Earth electrode, left-hand side
1 pc.

Variant	Item no.
□ white	143231

Long connector including longitudinal stiffene

Plastic / Steel
L: 6.5 cm W: 1.8 cm H: 1.7 cm
Weight: 0.09 kg
The connector is installed in the track, the stabiliser on the rear side of the track.
1 pc.

Variant	Item no.
□ white	143271

1-circuit adapter with hook

6A max.
Polycarbonate (PC)
L: 8.2 cm W: 3.5 cm H: 7.4 cm
Weight: 0.05 kg
Maximum mechanical load 20N.
For pendants with an additional mechanical suspension.
1 pc.

Variant	Item no.
■ black	143170
□ white	143171
■ grey	143172

Feed-in, earth on right side

16A max.
Plastic
L: 10.8 cm W: 5.5 cm H: 2 cm
Weight: 0.41 kg
Earth electrode, right-hand side
1 pc.

Variant	Item no.
□ white	143241

End caps, 2 pieces

Plastic
L: 2.7 cm W: 5.5 cm H: 1.8 cm
Weight: 0.01 kg
2 pc.

Variant	Item no.
□ white	143281

Pendant adapter

6A max.
Polycarbonate (PC)
L: 8.2 cm W: 3.5 cm H: 4.2 cm
Weight: 0.04 kg
Maximum mechanical load 20N.
Incl. strain relief
1 pc.

Variant	Item no.
■ black	143120
□ white	143121
■ grey	143124

1-CIRCUIT SURFACE MOUNTED TRACK PLANNING AID

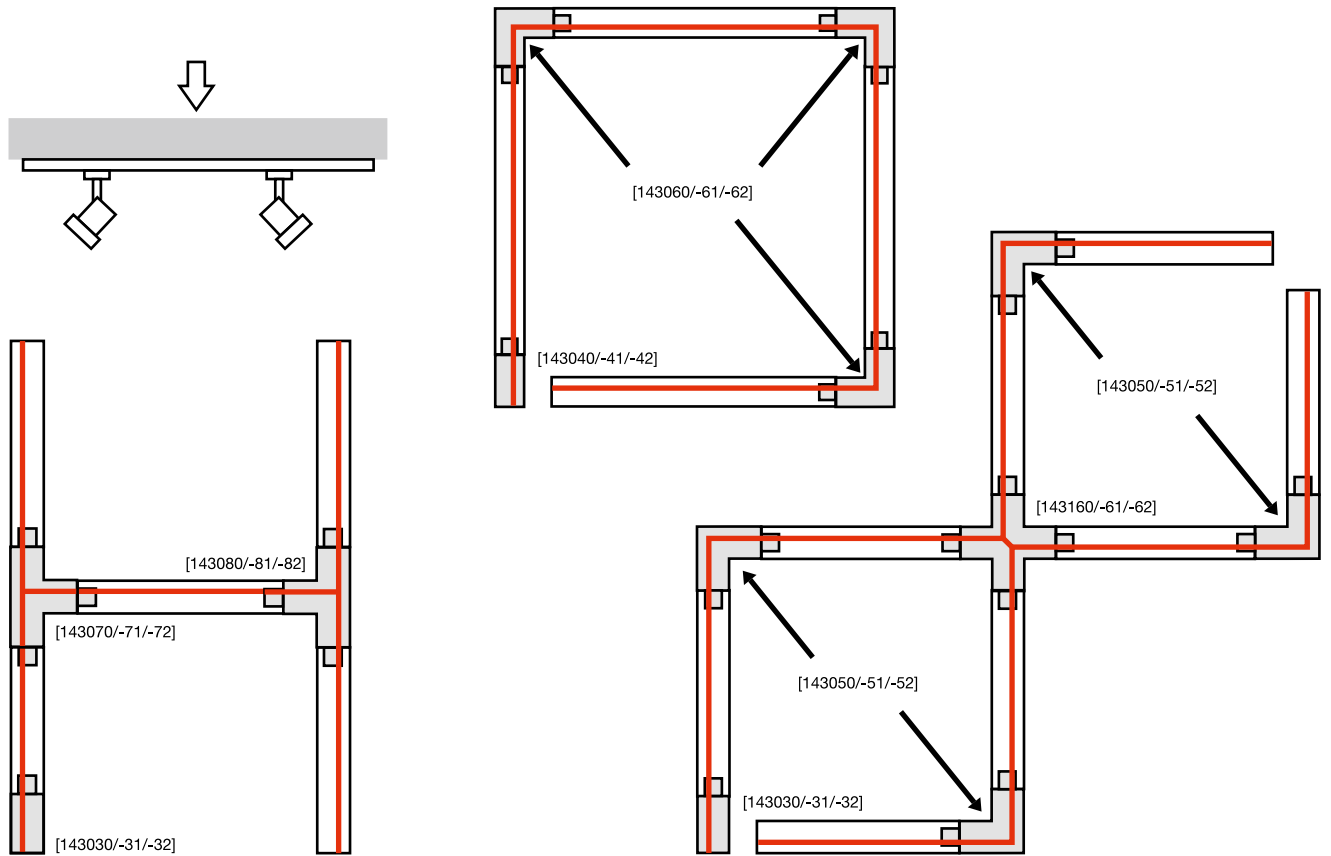

SURFACE-MOUNTED TRACKS 1 M



1-CIRCUIT SURFACE MOUNTED TRACK

1-CIRCUIT SURFACE MOUNTED TRACK

1-CIRCUIT SURFACE MOUNTED TRACK

Rated voltage	220-240V ~50/60Hz	220-240V ~50/60Hz	220-240V ~50Hz
Max. perm. current	16A	16A	16
Feed-in capability	no	no	no
Material	Aluminium	Aluminium	Aluminium
Colour	matt black	white	grey
Length	100 cm	100 cm	100 cm
Width	3.5 cm	3.5 cm	3.5 cm
Height	1.8 cm	1.8 cm	1.8 cm
Weight	0.67 kg	0.67 kg	0.67 kg
Item no.	143010	143011	143012

SURFACE-MOUNTED TRACKS 2 M



1-CIRCUIT SURFACE MOUNTED TRACK

1-CIRCUIT SURFACE MOUNTED TRACK

1-CIRCUIT SURFACE MOUNTED TRACK

Rated voltage	220-240V ~50/60Hz	220-240V ~50Hz	220-240V ~50/60Hz
Max. perm. current	16A	16A	16A
Feed-in capability	no	no	no
Material	Aluminium	Aluminium	Aluminium
Colour	matt black	white	grey
Length	200 cm	200 cm	200 cm
Width	3.5 cm	3.5 cm	3.5 cm
Height	1.8 cm	1.8 cm	1.8 cm
Weight	1.34 kg	1.34 kg	1.34 kg
Item no.	143020	143021	143022

SURFACE-MOUNTED TRACKS 3 M



1-CIRCUIT SURFACE MOUNTED TRACK

1-CIRCUIT SURFACE MOUNTED TRACK

1-CIRCUIT SURFACE MOUNTED TRACK

Rated voltage	230V, 50Hz, 60Hz	230V, 50Hz, 60Hz	230V, 50Hz, 60Hz
Max. perm. current	16A	16A	16A
Feed-in capability	no	no	no
Material	Aluminium	Aluminium	Aluminium
Colour	black	white	grey
Length	300 cm	300 cm	300 cm
Width	3.5 cm	3.5 cm	3.5 cm
Height	1.8 cm	1.8 cm	1.8 cm
Weight	1.6 kg	1.6 kg	1.6 kg
Item no.	1002151	1002152	1002153

1-CIRCUIT SURFACE MOUNTED TRACK ACCESSORIES

Ceiling suspension

Stainless steel / brass
L: 500 cm
Weight: 0.2 kg
2 pc.



Variant	Item no.
■ Nickel	1002845

Longitudinal connector, electric

16A max.
Polycarbonate (PC)
L: 6.4 cm W: 3.5 cm H: 1.8 cm
Weight: 0.02 kg
1 pc.



Variant	Item no.
■ black	143090
□ white	143091
■ grey	143092

End caps, 2 pieces

Polycarbonate (PC)
L: 0.4 cm W: 3.5 cm H: 1.8 cm
Weight: 0.01 kg
2 pc.



Variant	Item no.
■ black	143130
□ white	143131
■ grey	143132

Feed-in, earth on left side

16A max.
Polycarbonate (PC)
L: 10.4 cm W: 3.5 cm H: 1.8 cm
Weight: 0.04 kg
Earth electrode, left-hand side
1 pc.



Variant	Item no.
■ black	143030
□ white	143031
■ grey	143032

Longitudinal connector with feed-in capability

16A max.
Polycarbonate (PC)
L: 17.2 cm W: 3.5 cm H: 1.8 cm
Weight: 0.07 kg
1 pc.



Variant	Item no.
■ black	143100
□ white	143101
■ grey	143102

X-connector

16A max.
Polycarbonate (PC)
L: 9.5 cm W: 17.2 cm H: 1.8 cm
Weight: 0.13 kg
1 pc.



Variant	Item no.
■ black	143160
□ white	143161
■ grey	143162

Feed-in, earth on right side

16A max.
Polycarbonate (PC)
L: 10.4 cm W: 3.5 cm H: 1.8 cm
Weight: 0.04 kg
Earth electrode, right-hand side
1 pc.



Variant	Item no.
■ black	143040
□ white	143041
■ grey	143042

T-connector, earth on left side

16A max.
Polycarbonate (PC)
L: 17.2 cm W: 10.4 cm H: 1.8 cm
Weight: 0.1 kg
Earth electrode, left-hand side
1 pc.



Variant	Item no.
■ black	143070
□ white	143071
■ grey	143072

Stabiliser, X connector

Steel
L: 19.7 cm W: 19.7 cm H: 0.5 cm
Weight: 0.11 kg
For reinforcement when mounting several tracks with ceiling suspension (143140/-1/-2).
1 pc.



Variant	Item no.
■ grey	143169

Corner connector, earth on outside

16A max.
Polycarbonate (PC)
L: 10.4 cm W: 10.4 cm H: 1.8 cm
Weight: 0.07 kg
External earth electrode
1 pc.



Variant	Item no.
■ black	143050
□ white	143051
■ grey	143052

T-connector, earth on right

16A max.
Polycarbonate (PC)
L: 17.2 cm W: 10.4 cm H: 1.8 cm
Weight: 0.1 kg
Earth on right
1 pc.



Variant	Item no.
■ black	143080
□ white	143081
■ grey	143082

Stabiliser, long longitudinal connector

Steel
L: 19.7 cm W: 3.2 cm H: 1.3 cm
Weight: 0.08 kg
For reinforcement when mounting several tracks with ceiling suspension (143141/-2).
1 pc.



Variant	Item no.
■ matt nickel	143151

Corner connector, earth on inside

16A max.
Polycarbonate (PC)
L: 10.4 cm W: 10.4 cm H: 1.8 cm
Weight: 0.07 kg
Internal earth
1 pc.



Variant	Item no.
■ black	143060
□ white	143061
■ grey	143062

Flexible connector

16A max.
Polycarbonate (PC)
L: 16.4 cm W: 3.5 cm H: 1.8 cm
Weight: 0.1 kg
1 pc.



Variant	Item no.
■ black	143110
□ white	143111
■ grey	143112

Ceiling plate

6A max.
Polycarbonate (PC)
Ø: 12.1 cm H: 2.5 cm
Weight: 0.1 kg
1 pc.



Variant	Item no.
■ black	143380
□ white	143381
■ grey	143382

1-circuit Pendant adapter

6A max.
Plastic PC
L: 8.2 cm W: 3.5 cm H: 4.2 cm
Maximum mechanical load 20N.
1 pc.



Variant	Item no.
■ black	143120
□ white	143121
■ silver-grey	143124



SNAPPY AND CHIC.

THE DECORATIVE EASYTEC® II HIGH-VOLTAGE TRACK SYSTEM.

You can create an individual light atmosphere in just a few steps with the decorative track system. The aluminium carrier tracks are available in different colours, and can therefore be ideally attuned to your room environment.





184450 411

184440 411



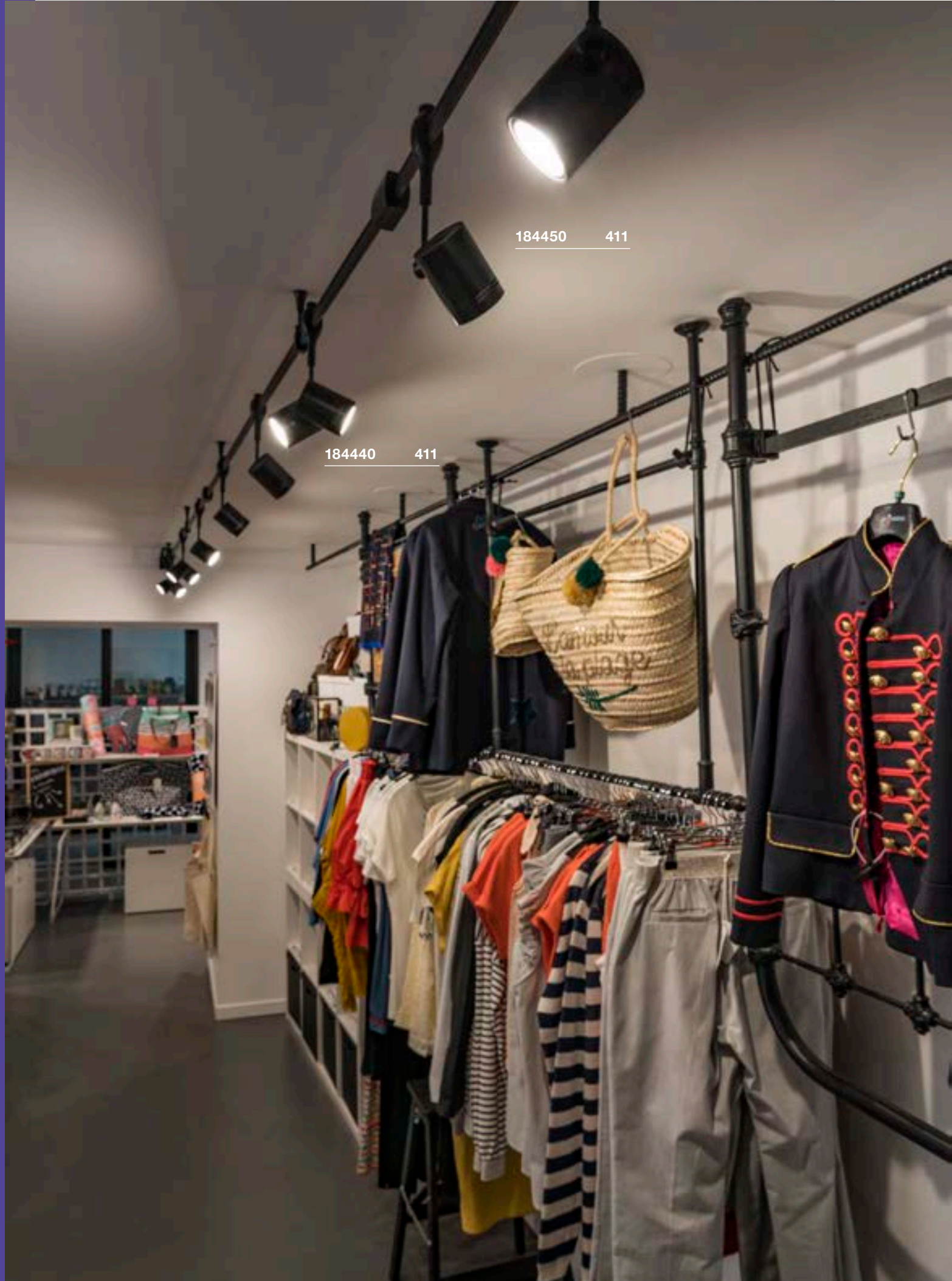

184450 411

184440 411

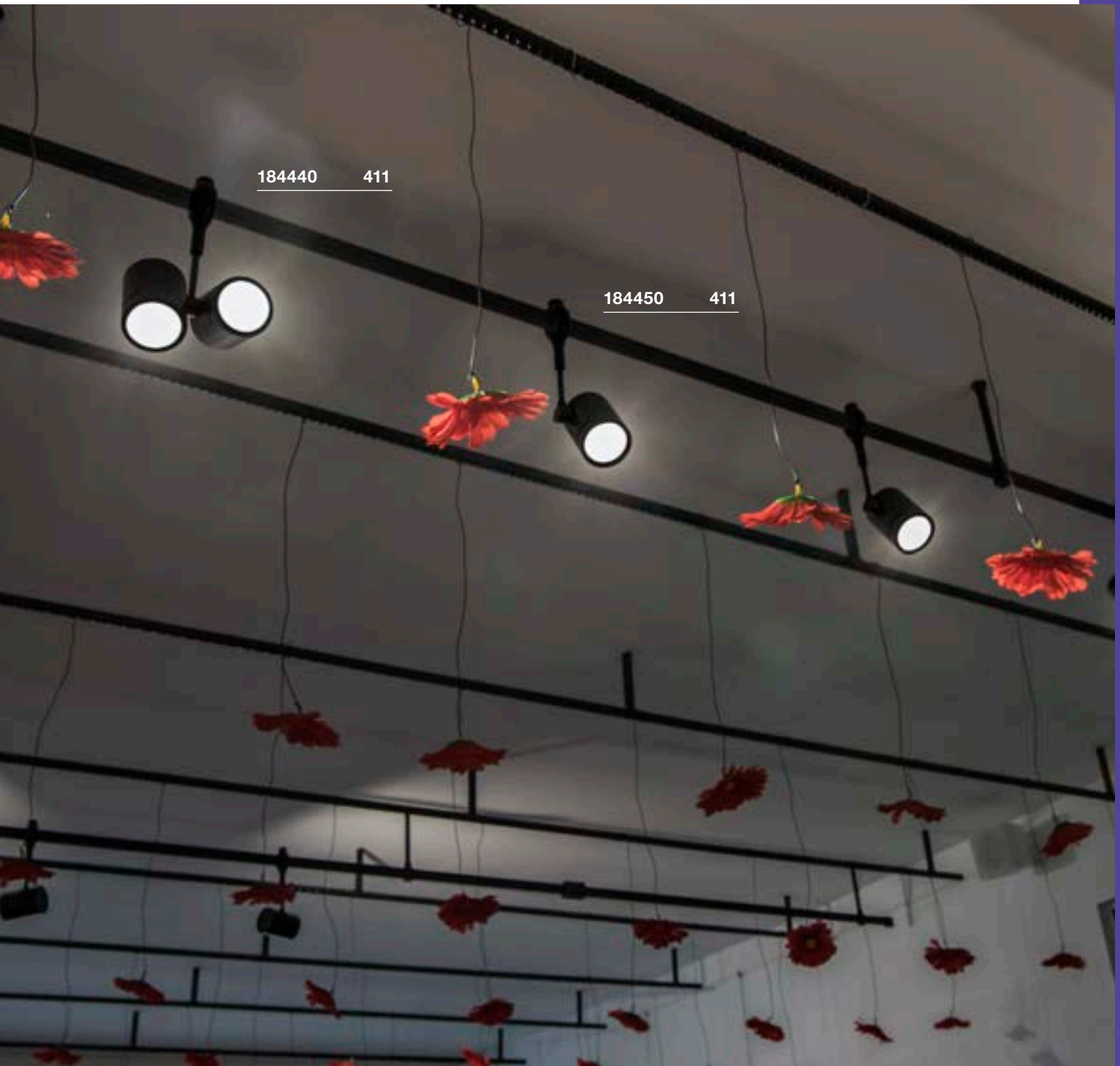

184440 411

184450 411

240V TRACK EASYTEC® II



Suitable tracks and accessories can be found on page 415

Other luminaires and variants can be found online at www.slv.com

HELIA 50 TRACK
EASYTEC® II



888

A-A++ Range
A++-E



- Premium LED with CRI>90

Product details

220-240V ~50/60Hz | 500mA
Total consumption: 11W
Material: Aluminium

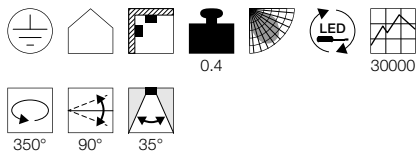

Dimensioned drawing

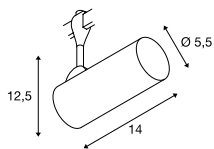

185450 411

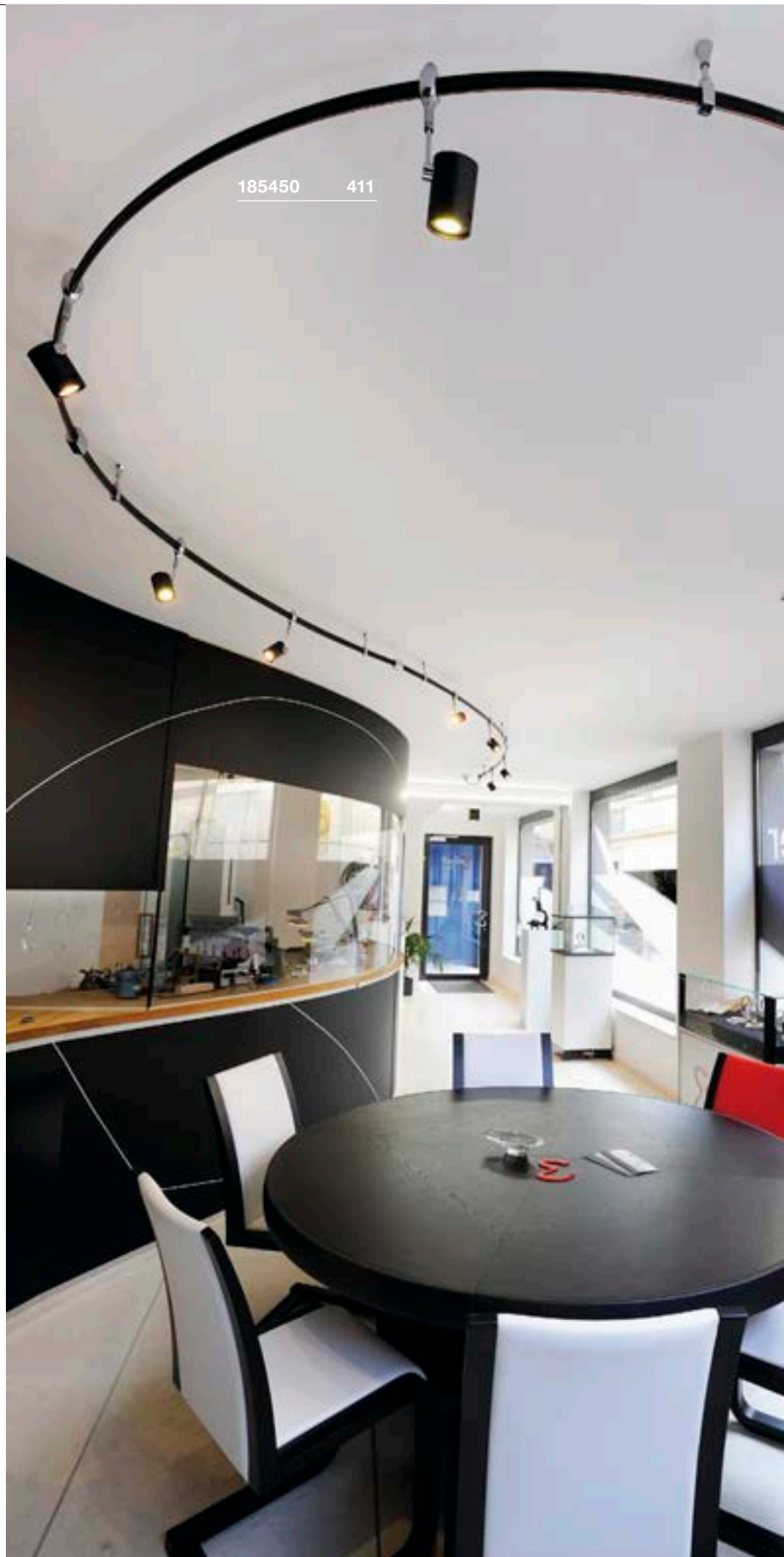

Variant	Item no.
750lm 3000K CRI>90 ■ black	184560

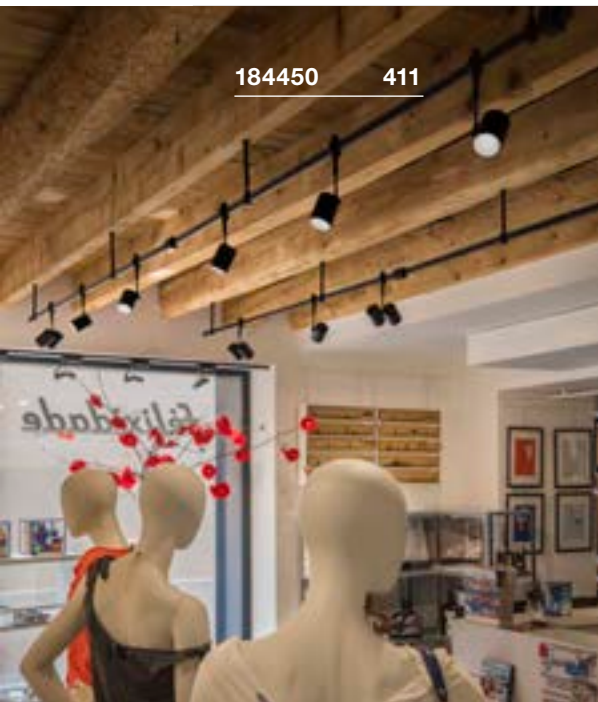

184450 411



184450 411



184440 411

BIMA
EASYTEC® II, single,
QPAR51



E-A++ Range A++-E

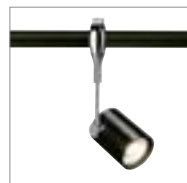

Product details

220-240V ~50/60Hz
Material: Aluminium

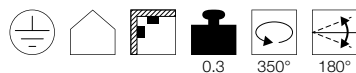

0.3 350° 180°

Dimensioned drawing

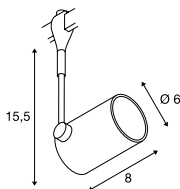

BIMA 2
EASYTEC® II, double,
QPAR51



E-A++ Range A++-E

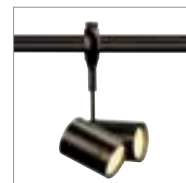

Product details

220-240V ~50/60Hz
Material: Aluminium

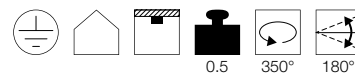

0.5 350° 180°

Dimensioned drawing

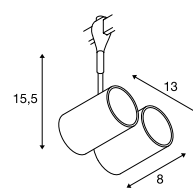

Recommended lamp

LED GU10 7.2W 36°
3000K 520lm EEL=A+
8kWh/1000h
Item no. 1001563



LED GU10 5.5W 38°
2700K 400lm EEL=A+
6kWh/1000h
Item no. 1001030



Lamp details

max. 50W QPAR51
Ø: 5.1 cm max. L: 5.7 cm max.

Variant	Item no.
GU10 QPAR51	
■ black	184450
■ chrome / black	185450
■ grey	184452

Recommended lamp

LED GU10 7.2W 36°
3000K 520lm EEL=A+
8kWh/1000h
Item no. 1001563



LED GU10 5.5W 38°
2700K 400lm EEL=A+
6kWh/1000h
Item no. 1001030



Lamp details

2x max. 50W QPAR51
Ø: 5.1 cm max. L: 5.7 cm max.

Variant	Item no.
GU10 QPAR51	
■ black	184440
■ chrome / black	185440

KANO
EASYTEC® II, QPAR51



ANILA
EASYTEC® II, QPAR51



YOKI
EASYTEC® II, QPAR111

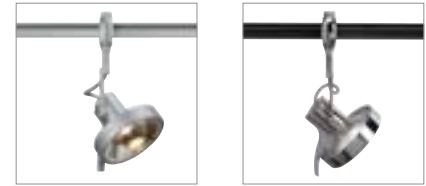

Product details

220-240V ~50/60Hz
Material: Aluminium / Glass



Product details

230V ~50Hz
Material: Aluminium / Glass

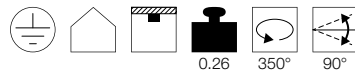

Product details

220-240V ~50/60Hz
Material: Aluminium

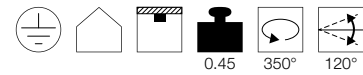

Dimensioned drawing

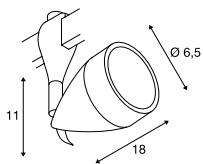

Dimensioned drawing

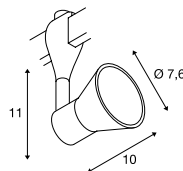

Dimensioned drawing

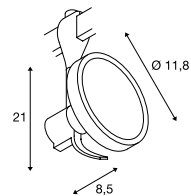

Recommended lamp

LED GU10 5.5W 36°
2700K 400lm EEL=A+
6kWh/1000h
Item no. 1001030



LED GU10 7.2W 36°
3000K 520lm EEL=A+
8kWh/1000h
Item no. 1001562



Recommended lamp

LED GU10 7.2W 36°
4000K 540lm EEL=A+
8kWh/1000h
Item no. 1001565



LED GU10 7.2W 36°
2700K 520lm EEL=A+
8kWh/1000h
Item no. 1001560



Recommended lamp

GU10 7W 40°
3000K 560lm EEL=A+
8kWh/1000h
Item no. 1001573



LED GU10 13W 30°
2700K 1100lm EEL=A+
13kWh/1000h
Item no. 1001242



Lamp details

max. 50W QPAR51
Ø: 5.1 cm max. L: 5.7 cm max.

Lamp details

max. 50W QPAR51
Ø: 5.1 cm max. L: 5.7 cm max.

Lamp details

max. 75W QPAR111

Variant	Item no.
GU10 QPAR51	
■ grey / matt transparent	184071

Variant	Item no.
GU10 QPAR51	
■ black	184630
GU10 QPAR51	
■ chrome	185632
GU10 QPAR51	
■ grey / transparent	184634

Variant	Item no.
GU10 QPAR111	
■ black	184620
GU10 QPAR111	
■ chrome	185622
GU10 QPAR111	
■ grey	184624



185692 413



185692 413

LIGHT EYE® 90
TRACK
EASYTEC® II, QPAR51



E-A++ Range A++-E



- The optimal deco ring for the lamp in the appropriate colour reduces the distance between housing and lamp

Product details

230V ~50Hz
Material: Steel

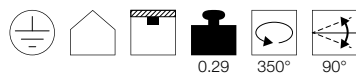

0.29 350° 90°

Dimensioned drawing

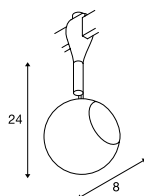

Recommended accessories

■ Lamp deco ring diam. 5.7cm
Item no. 151049



Recommended lamp

LED GU10 5.5W 38°
2700K 400lm EEL=A+
6kWh/1000h
Item no. 1001030



LED GU10 7.2W 36°
2700K 470lm EEL=A+
8kWh/1000h
Item no. 560542



Lamp details

max. 50W QPAR51
Ø: 5.1 cm max. L: 5.7 cm max.

Variant	Item no.
GU10 QPAR51	
■ black	184690
GU10 QPAR51	
■ chrome	185692

LIGHT EYE® 150
TRACK
EASYTEC® II, QPAR111



E-A++ Range A++-E



Product details

230V ~50Hz
Material: Steel

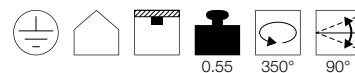

0.55 350° 90°

Dimensioned drawing

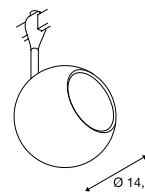

Recommended accessories

Recommended lamp

LED GU10 10W 38°
3000K 630lm EEL=A+
10kWh/1000h
Item no. 1001029



LED GU10 7W 13°
3000K 660lm EEL=A+
8kWh/1000h
Item no. 1001568



Lamp details

max. 75W QPAR111

Variant	Item no.
GU10 QPAR111	
■ black	184580
GU10 QPAR111	
■ chrome	185582
GU10 QPAR111	
■ black / chrome	185580

LIGHT EYE® 150

TRACK
EASYTEC® II, PD, QPAR111



E-A++ Range
A++-E



Product details

230V ~50Hz
Material: Steel

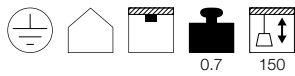

Dimensioned drawing

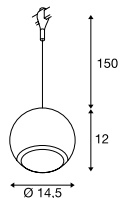

Recommended lamp

GU10 7.9W 40°
4000K 760lm EEL=A+
8kWh/1000h
Item no. 560724



LED GU10 13W 30°
2700K 1100lm EEL=A+
13kWh/1000h
Item no. 1001242



Lamp details

max. 75W QPAR111

Variant	Item no.
GU10 QPAR111	
■ black	184590
GU10 QPAR111	
■ chrome / black	185590
GU10 QPAR111	
■ chrome	185592

TONGA®
EASYTEC® II, PD, E14



E-A++ Range
A++-E



• Ceramic shade

Product details

230V ~50Hz
Material: Aluminium / Glass

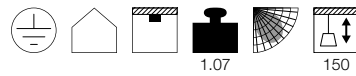

Dimensioned drawing

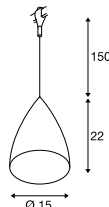

Recommended lamp

E14 3.4W 260°
3000K 250lm EEL=A+
4kWh/1000h
Item no. 560362



LED E14 6.5W 280°
3000K 480lm EEL=A+
7kWh/1000h
Item no. 560372



Lamp details

max. 60W C35
Ø: 5 cm max. L: 13 cm max.

Variant	Item no.
E14 C35	
■ black / white	184530
E14 C35	
■ grey / shiny opaque	184534



185590 414



133444 414

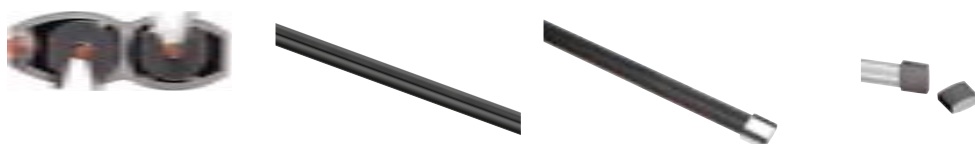

	EASYTEC® II Track 2m, incl. end caps	EASYTEC® II Track 2m, incl. end caps	EASYTEC® II Track 2m, incl. end caps
Rated voltage	230V ~50Hz	230V ~50Hz	230V ~50Hz
Max. perm. current	16A	16A	16A
Feed-in capability	no	no	no
Material	Aluminium	Aluminium	Aluminium
Colour	black	black / chrome	grey
Length	200 cm	200 cm	200 cm
Width	1 cm	1 cm	1 cm
Height	3 cm	3 cm	3 cm
Weight	1 kg	1 kg	1 kg
Item no.	184020	185020	184022

Feed-in

16A max.
Aluminium / Glass
L: 7.5 cm W: 7.5 cm H: 6 cm
Weight: 0.23 kg
1 pc.



Variant	Item no.
■ black	184004
■ chrome	185002
■ grey	184002

Ceiling suspension, flexible

Aluminium
Weight: 0.11 kg
1 pc.



Variant	Item no.
■ black	184060
■ black / chrome	185062
■ grey	184062

Flexible connector

16A max.
Plastic
L: 21.5 cm W: 3 cm H: 4 cm
Weight: 0.3 kg
1 pc.



Variant	Item no.
■ black	184300
■ chrome	185302
■ grey	184302

Shortbox

16A max.
Aluminium / Steel
W: 22 cm H: 10.5 cm D: 6 cm
Weight: 0.57 kg
Simple installation of the tracks is possible with the Shortbox. In the case of a lateral protrusion of >75 cm, a 10 cm ceiling suspension is required.
1 pc.



Variant	Item no.
■ black	184010
■ black / chrome	185012
■ grey	184012

End caps

Plastic
Weight: 0.03 kg
2 pc.



Variant	Item no.
■ black	184140
■ chrome / black	185142
■ grey	184142

Flexible ceiling bracket

Aluminium
Weight: 0.1 kg
1 pc.



Variant	Item no.
■ grey	184332
■ black	184330

Long connector

16A max.
Aluminium
Weight: 0.08 kg
1 pc.



Variant	Item no.
■ black	184030
■ chrome	185032
■ grey	184032

Insulating connector

Aluminium
Weight: 0.08 kg
1 pc.



Variant	Item no.
■ black	184170
■ chrome	185172
■ grey	184172

Bending machine

Steel / Plastic
Weight: 2.76 kg
1 pc.



Variant	Item no.
■ grey	184000

Ceiling suspension

Aluminium
L: 10 cm
Weight: 0.1 kg
1 pc.



Variant	Item no.
■ black	184040
■ chrome	185042
■ grey	184042

Pendant adapter

3A max.
Aluminium / Plastic
L: 13 cm
Weight: 0.1 kg
1 pc.



Variant	Item no.
■ black	184290
■ chrome	185294
■ grey	184292

LOVE OF DETAIL.

LOW-VOLTAGE CABLE SYSTEM AND DISPLAY CASE RAILS CREATE EMPHASIS.

Light helps to give rooms atmosphere. Anywhere where it needs to be cosy and professional at the same time, low voltage cable systems are the right solution – because they provide room for individual lighting concepts and create cosiness. Our low-voltage display case rails are the ideal solution for accentuating product display cases.

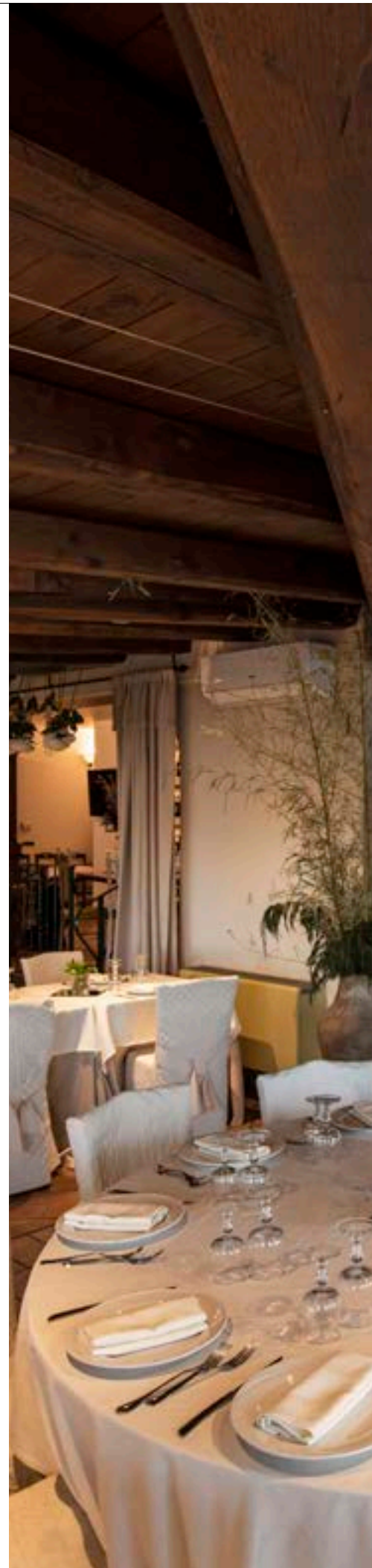



139112 423



139131 422





LOW-VOLTAGE CABLE SYSTEM AND GLASS CABINET TRACK



Suitable accessories can be found on pages 426, 427, 429 and 431

 Other luminaires and variants can be found online at www.slv.com

ASMARA
LV, QR-C51

C-A+ Range A++-E

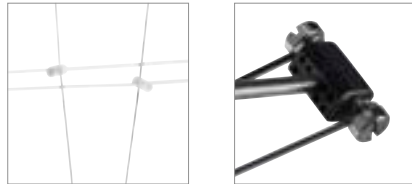

Product details

12V ~50Hz
Material: Stainless Steel

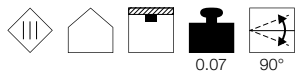

Dimensioned drawing

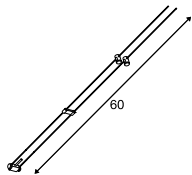

Recommended lamp

LED GU5.3 5.5W 36°
2700K 450lm EEL=A+
7kWh/1000h
Item no. 1001574



LED GU5.3 5.5W 36°
3000K 460lm EEL=A+
7kWh/1000h
Item no. 1001575



Lamp details

max. 35W QR-C51

Variant	Item no.
GX5.3 QR-C51	
■ black	139070
GX5.3 QR-C51	
□ white	139071
GX5.3 QR-C51	
■ chrome	139072

TELESKOP
LV, QR-C51

C-A+ Range A++-E

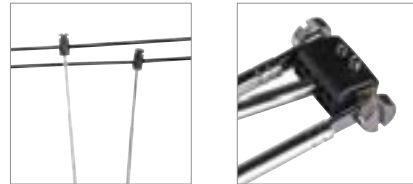

Product details

12V ~50Hz
Material: Brass / Steel

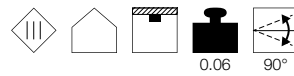

Dimensioned drawing

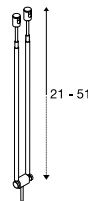

Note

Telescopic from 21-51 cm

Recommended lamp

LED GU5.3 5.5W 36°
2700K 450lm EEL=A+
7kWh/1000h
Item no. 1001574



LED GU5.3 5.5W 36°
3000K 460lm EEL=A+
7kWh/1000h
Item no. 1001575



Lamp details

max. 20W QR-C51

Variant	Item no.
GX5.3 QR-C51	
■ black	139080
GX5.3 QR-C51	
□ white	139081
GX5.3 QR-C51	
■ chrome	139082



139071 420



139081 420



139090 421



139102 421

COSMIC
LV, QR-C51



SYROS
LV, QR-C51



Product details

12V ~50Hz
Material: Steel / Brass

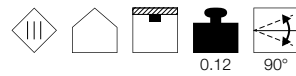

Dimensioned drawing

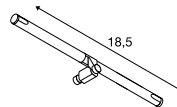

Product details

12V ~50Hz
Material: Steel / Brass

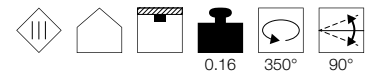

Dimensioned drawing

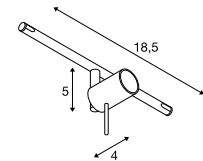

Recommended lamp

LED GU5.3 5.5W 36°
2700K 450lm EEL=A+
7kWh/1000h
Item no. 1001574



LED GU5.3 5.5W 36°
3000K 460lm EEL=A+
7kWh/1000h
Item no. 1001575



Lamp details

max. 35W QR-C51

Variant	Item no.
GX5.3 QR-C51	
■ black	139090
GX5.3 QR-C51	
□ white	139091
GX5.3 QR-C51	
■ chrome	139092

Recommended lamp

LED GU5.3 5.5W 36°
2700K 450lm EEL=A+
7kWh/1000h
Item no. 1001574



LED GU5.3 5.5W 36°
3000K 460lm EEL=A+
7kWh/1000h
Item no. 1001575



Lamp details

max. 50W QR-C51

Variant	Item no.
GX5.3 QR-C51	
■ black	139100
GX5.3 QR-C51	
□ white	139101
GX5.3 QR-C51	
■ chrome	139102

SALUNA
LV, QR-C51

C-A+ Range A++-E

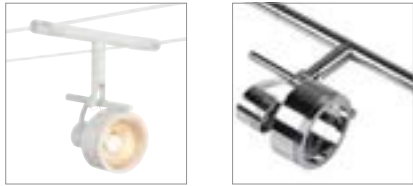

Product details

12V ~50Hz
Material: Steel / Brass

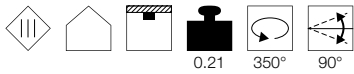

0.21 350° 90°

Dimensioned drawing

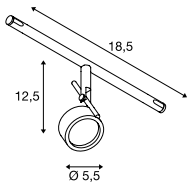

Recommended lamp

LED GU5.3 5.5W 36°
2700K 450lm EEL=A+
7kWh/1000h

Item no. 1001574



LED GU5.3 5.5W 36°
3000K 460lm EEL=A+
7kWh/1000h

Item no. 1001575



Lamp details

max. 35W QR-C51

Variant	Item no.
GX5.3 QR-C51	
■ black	139130
GX5.3 QR-C51	
□ white	139131
GX5.3 QR-C51	
■ chrome	139132

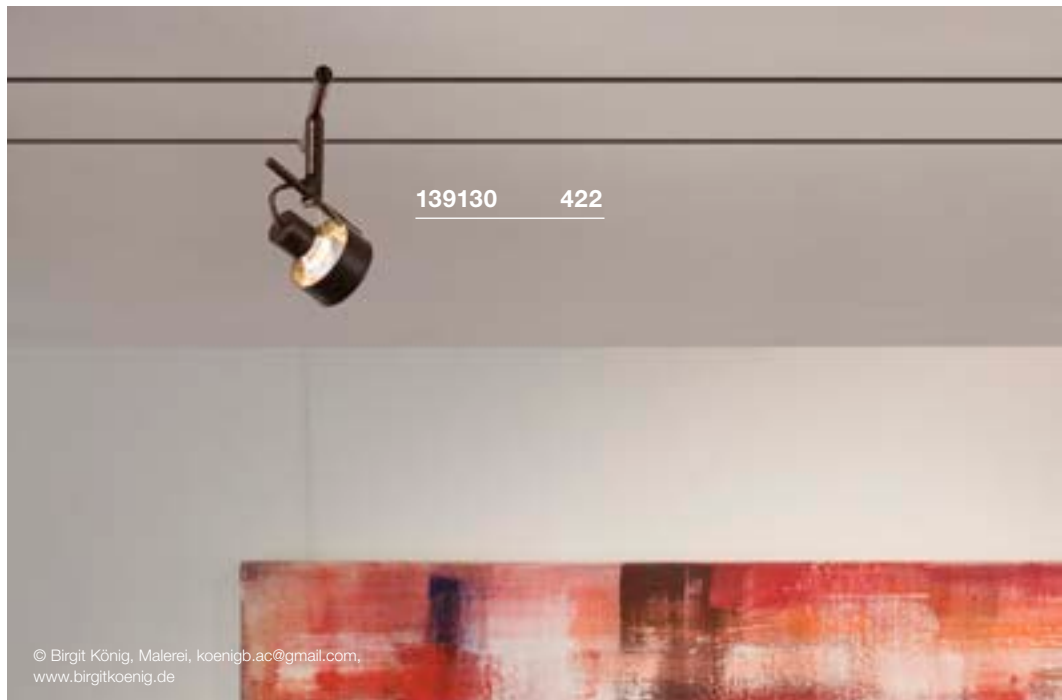

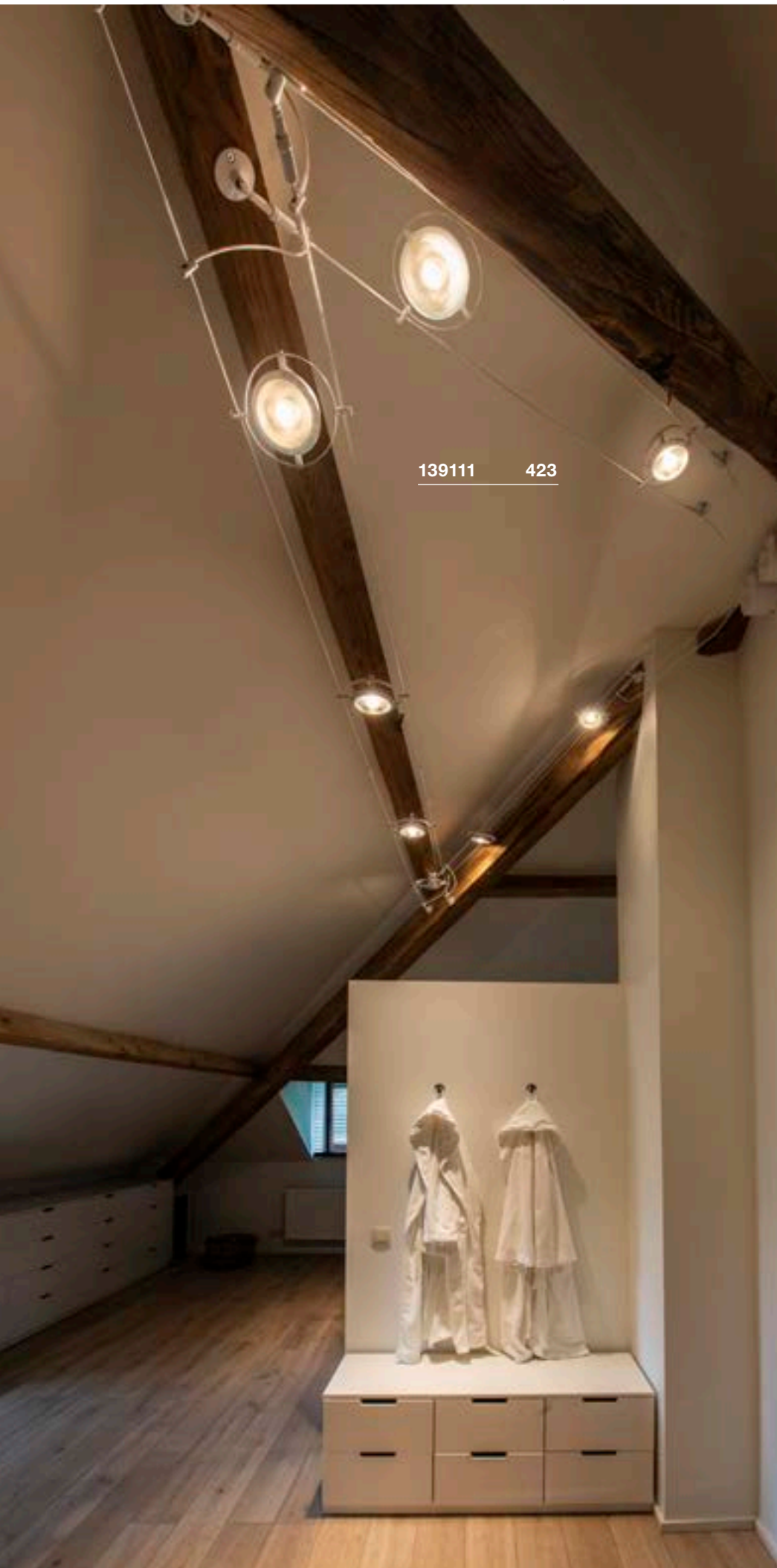

139111 423

QRB LV, QR111

C-A+ Range
A++-E

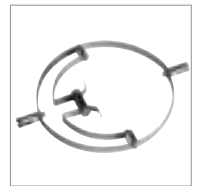

Product details

12V ~50Hz
Material: Steel

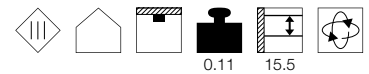

0.11 15.5

Dimensioned drawing

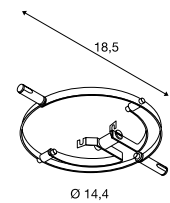

Recommended lamp

LED G53 15W 40°
2700K 750lm EEL=A
17kWh/1000h
Item no. 560232



LED G53 15W 40°
3000K 760lm EEL=A
17kWh/1000h
Item no. 560234



Lamp details

max. 50W QR111

Variant	Item no.
G53 QR111	
■ black	139110
G53 QR111	
□ white	139111
G53 QR111	
■ chrome	139112

NOBLO SPOT
LV, Rope Track



A-A++ Range
A++-E



LED
INSIDE

NEW
VARIANT



1002695 424

Product details

12V ~50Hz
Material: Aluminium / Polymethylacrylate (PMMA)

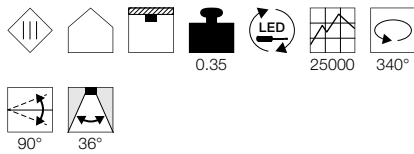

Dimensioned drawing

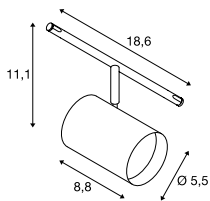

Variant	Item no.
420lm 2700K CRI>80	
■ black	1002694
450lm 2700K CRI>80	
□ white	1002695
450lm 2700K CRI>80	
■ chrome	1002696





1002690 425



139120 425

COMET
LV, QR-C51

C-A+ Range A++-E



COMET LED
LV

A-A++ Range A++-E



LED INSIDE

NEW VARIANT



• Frosted glass body

Product details

12V ~50Hz
Material: Brass / Brass

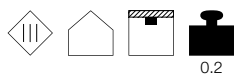

0.2

Product details

12V ~50Hz
Total consumption: 6.3W
Material: Aluminium / Glass



0.257

25000

Dimensioned drawing

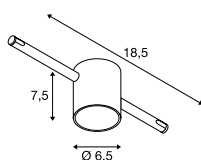

Dimensioned drawing

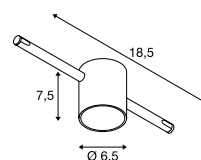

Recommended lamp

LED GU5.3 5.5W 36°
2700K 450lm EEL=A+
7kWh/1000h

Item no. 1001574



LED GU5.3 5.5W 36°
3000K 460lm EEL=A+
7kWh/1000h

Item no. 1001575



Lamp details

max. 50W QR-C51

Variant	Item no.
GU5.3 QR-C51	
■ black / transparent	139120
GU5.3 QR-C51	
□ white / matt transparent	139121
GU5.3 QR-C51	
■ chrome	139122

Variant	Item no.
410lm 2700K CRI>80	
■ black / frosted	1002688
410lm 2700K CRI>80	
□ white / frosted	1002689
410lm 2700K CRI>80	
■ chrome / frosted	1002690

COMPOSITION SCHEME

Rope system, wall-to-wall installation scheme (rope system perpendicular to wall)

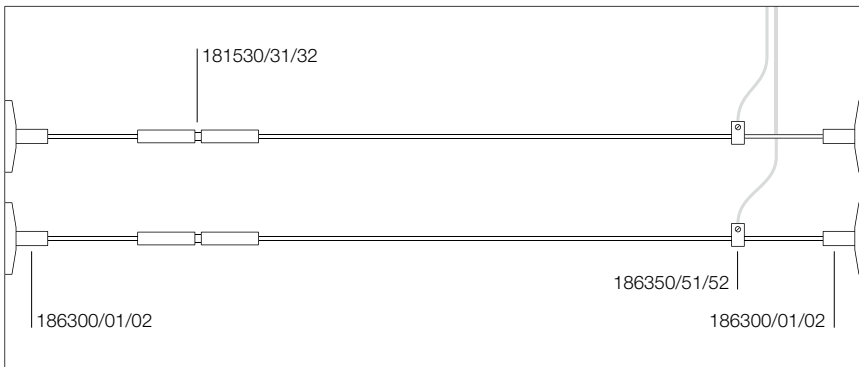

Articles/codes needed for this composition

Wall bracket	186300/01/02	x 2pz
Feed-in	186350/51/52	x 1pz
Wire tensioner	181530/31/32	x 1pz

Rope system, wall-to-wall installation scheme, no wire tensioner (rope system perpendicular to wall)

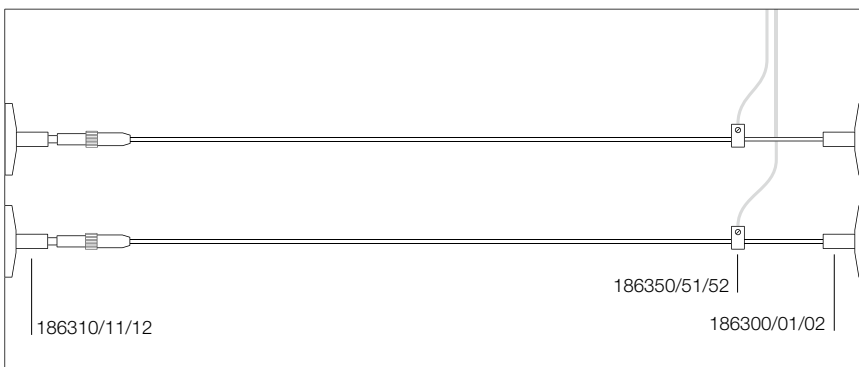

Articles/codes needed for this composition

Wall bracket	186300/01/02	x 1pz
Flexible wall bracket	186310/11/12	x 1pz
Feed-in	186350/51/52	x 1pz

Rope system, wall-to-wall installation scheme, with changing in direction

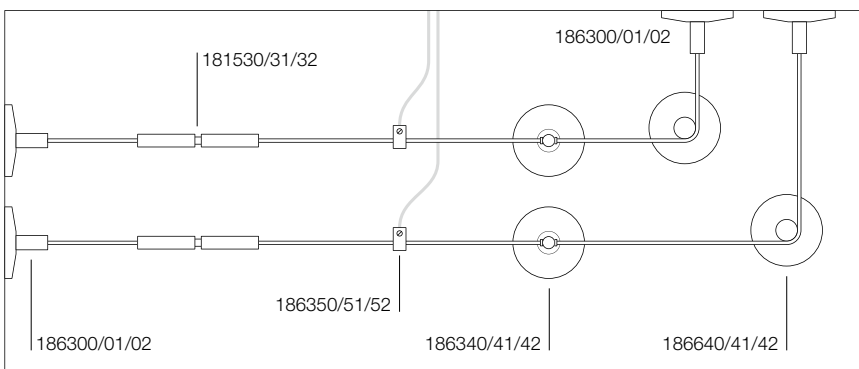

Articles/codes needed for this composition

Wall bracket	186300/01/02	x 2pz
Deviator*	186640/41/42	x 1pz
Ceiling support	186340/41/42	x 1pz
Wire tensioner	181530/31/32	x 1pz
Feed-in	186350/51/52	x 1pz

*Pay attention: deflec ors don't work as support. Please choose ceiling supports as proper accessories to anchor the system to the ceiling.

Cable lighting system, wall-to-wall installation scheme (walls NOT perpendicular to cable system)

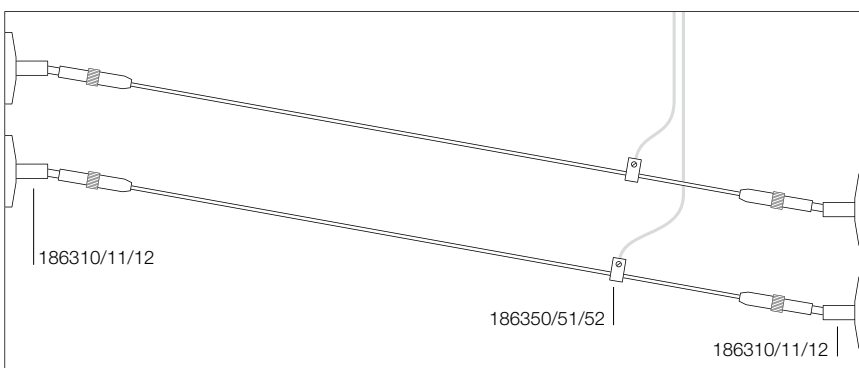

Articles/codes needed for this composition

Flexible wall bracket	186310/11/12	x 2pz
Feed-in	186350/51/52	x 1pz

COMPOSITION SCHEME

Rope system, wall-to-wall installation scheme, double switch

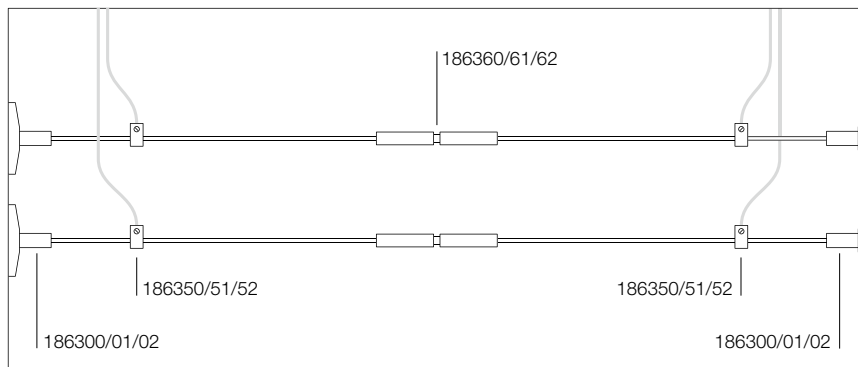

Articles/codes needed for this composition

Wall bracket	186300/01/02	x 2pz
Insulating connector	186360/61/62	x 1pz
Wire tensioner	181530/31/32	x 1pz
Feed-in	186350/51/52	x 2pz

Rope system, wall-to-ceiling installation scheme

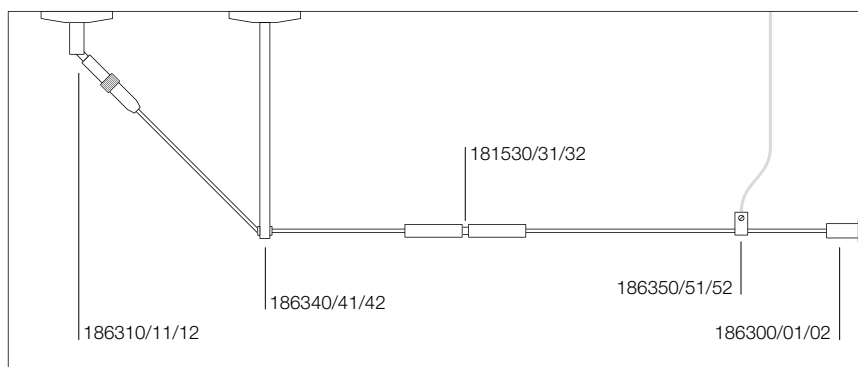

Articles/codes needed for this composition

Wall bracket	186300/01/02	x 1pz
Flexible wall bracket	186310/11/12	x 1pz
Wire tensioner	181530/31/32	x 1pz
Ceiling Spacer 16 cm	186340/41/42	x 1pz
Feed-in	186350/51/52	x 1pz

Rope system, ceiling-to-ceiling installation scheme

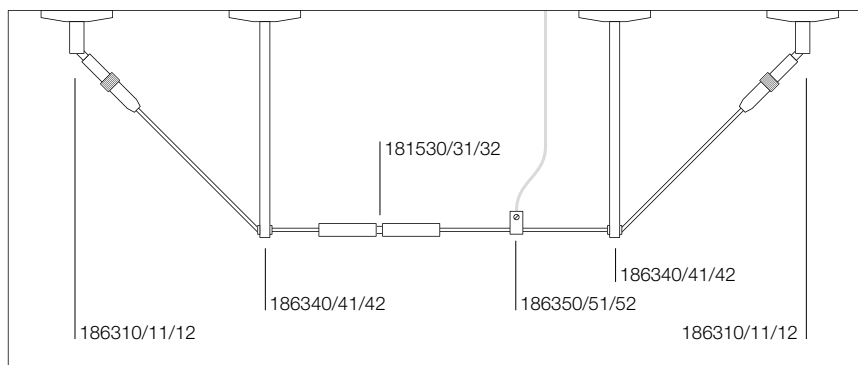

Articles/codes needed for this composition

Flexible wall bracket	186310/11/12	x 2pz
Wire tensioner	181530/31/32	x 1pz
Ceiling Spacer 16 cm	186340/41/42	x 2pz
Feed-in	186350/51/52	x 1pz

NOTE

All accessories are sold in 2 pieces per item number. The price is referred to a two pieces package.

12V cable is covered with insulating sheath.

Please use only toroidal transformer. Our toroidal transformer are dimmable TRIAC.
Please take into consideration the installed power load and choose your transformer accordingly.



Low-voltage cable
4 mm², 10 m



TENSEO
4 mm², 10m

TENSEO
4 mm², 10 m

TENSEO
4 mm², 10 m

			
Max. perm. voltage	48V	48V	48V
Max. perm. current	25A	25A	25A
Material	Copper / Plastic	Copper / Plastic	Copper / Plastic
Colour	black	white	transparent
Diameter	0.4 cm	0.4 cm	0.4 cm
Length	1000 cm	1000 cm	1000 cm
Weight	0.48 kg	0.48 kg	0.48 kg
Item no.	1002602	1002603	1002604



Low-voltage cable
4 mm², 20 m



TENSEO
4 mm², 20 m

TENSEO
4 mm², 20 m

TENSEO
4 mm², 20 m

			
Max. perm. voltage	48V	48V	48V
Max. perm. current	25A	25A	25A
Material	Copper / Plastic	Copper / Plastic	Copper / Plastic
Colour	black	white	transparent
Diameter	0.4 cm	0.4 cm	0.4 cm
Length	2000 cm	2000 cm	2000 cm
Weight	0.88 kg	0.88 kg	0.85 kg
Item no.	139030	139031	139024



Low-voltage cable
4 mm², 100 m



TENSEO
4 mm², 100 m

TENSEO
4 mm², 100 m

TENSEO
4 mm², 100 m

			
Max. perm. voltage	48V	48V	48V
Max. perm. current	25A	25A	25A
Material	Copper / Plastic	Copper / Plastic	Copper / Plastic
Colour	black	white	transparent
Diameter	0.4 cm	0.4 cm	0.4 cm
Length	10000 cm	10000 cm	10000 cm
Weight	4.4 kg	4.4 kg	4.26 kg
Item no.	139040	139041	139004



Low-voltage cable
6 mm², 20 m



TENSEO
6 mm², 20 m

TENSEO
6 mm², 20 m

TENSEO
6 mm², 20 m

			
Max. perm. voltage	48V	48V	48V
Max. perm. current	25A	25A	25A
Material	Copper / Plastic	Copper / Plastic	Copper / Plastic
Colour	black	white	transparent
Diameter	0.4 cm	0.4 cm	0.4 cm
Length	2000 cm	2000 cm	2000 cm
Weight	1.23 kg	1.23 kg	1.21 kg
Item no.	139050	139051	139026

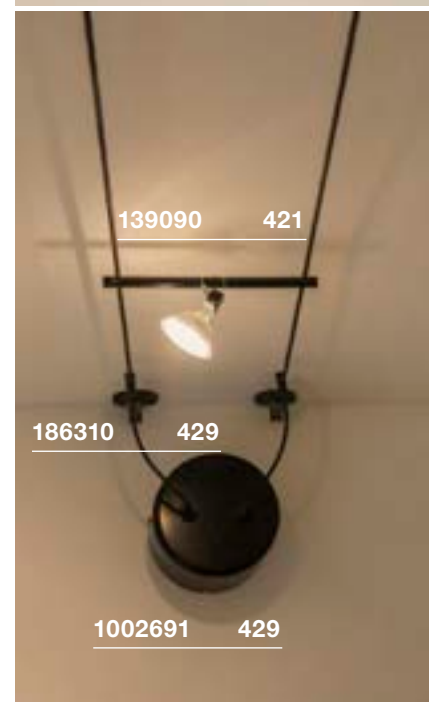
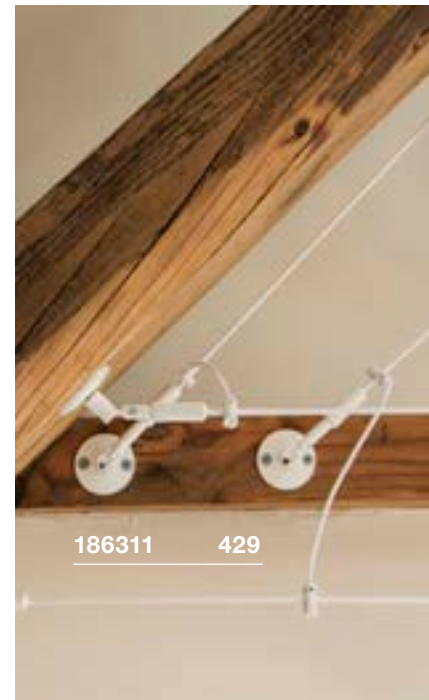
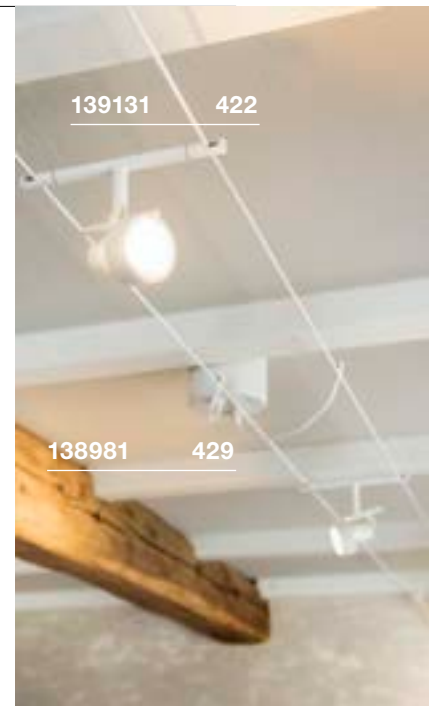

Low-voltage cable
6 mm², 100 m



	TENSEO 6 mm ² , 100 m	TENSEO 6 mm ² , 100 m	TENSEO 6 mm ² , 100 m
Max. perm. voltage	48V	48V	48V
Max. perm. current	25A	25A	25A
Material	Copper / Plastic	Copper / Plastic	Copper / Plastic
Colour	black	white	transparent
Diameter	0.4 cm	0.4 cm	0.4 cm
Length	10000 cm	10000 cm	10000 cm
Weight	6.1 kg	6.1 kg	6 kg
Item no.	139060	139061	139006

ACCESSORIES LOW-VOLTAGE CABLE SYSTEM TENSEO

TRANSFORMER 12V AC | 50VA conventional

Steel / Brass
Ø: 11.1 cm H: 11 cm
Weight: 1.88 kg
1 pc.



Variant	Item no.
■ black	1002691
□ white	1002692
■ chrome	1002693

Wall bracket 10cm

Steel / Brass
Ø: 5 cm H: 11.5 cm
Weight: 0.08 kg
2 pc.



Variant	Item no.
■ black	186310
□ white	186311
■ chrome	186312

Ceiling diffuse

Steel / Brass
Ø: 5 cm H: 16 cm
Weight: 0.39 kg
2 pc.



Variant	Item no.
■ black	186640
□ white	186641
■ chrome	186642

Transformer 12V | 105VA conventional

Steel / Brass
Ø: 11 cm H: 11 cm
Weight: 1.6 kg
1 pc.



Variant	Item no.
■ black	138980
□ white	138981
■ chrome	138982

Deflec or 6cm

Steel / Brass
Ø: 5 cm H: 6 cm
Weight: 0.05 kg
2 pc.



Variant	Item no.
■ black	186330
□ white	186331
■ chrome	186332

Suspension set 2m

Steel / Aluminium
Ø: 1.25 cm W: 18.6 cm
Weight: 0.162 kg
1 pc.



Variant	Item no.
■ black	1002697
□ white	1002698
■ chrome	1002699

Transformer 12V | 210VA conventional

Steel / Brass
Ø: 13.5 cm H: 11 cm
Weight: 3.05 kg
1 pc.



Variant	Item no.
■ black	138990
□ white	138991
■ chrome	138992

Diffuse

Steel / Brass
Ø: 5 cm H: 16 cm
Weight: 0.12 kg
2 pc.



Variant	Item no.
■ black	186340
□ white	186341
■ chrome	186342

Spacer

Aluminium
Ø: 1.25 cm W: 9 cm
Weight: 0.35 kg
2 pc.



Variant	Item no.
■ black	1002700
□ white	1002701
■ chrome	1002702

Cable tensioner

25A max.
Brass
Ø: 1 cm H: 11 cm
Weight: 0.04 kg
2 pc.



Variant	Item no.
■ black	181530
□ white	181531
■ chrome	181532

Feed-in

25A max.
Brass
Ø: 1 cm H: 1.8 cm
Weight: 0.04 kg
2 pc.



Variant	Item no.
■ black	186350
□ white	186351
■ chrome	186352

Spacer with connector

25A max.
Brass
Ø: 1.25 cm W: 9 cm
Weight: 0.82 kg
2 pc.



Variant	Item no.
■ black	1002703
□ white	1002704
■ chrome	1002705

Wall bracket

Steel / Brass
Ø: 5 cm L: 3 cm
Weight: 0.05 kg
2 pc.



Variant	Item no.
■ black	186300
□ white	186301
■ chrome	186302

Insulating connector

25A max.
Aluminium / Plastic
Ø: 1 cm L: 6.4 cm
Weight: 0.04 kg
2 pc.



Variant	Item no.
■ black	186360
□ white	186361
■ chrome	186362

M-TRACK
Adjustable light

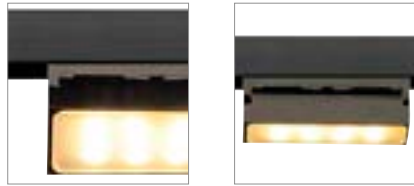

• Spots easy to move due to magnetic holder

Product details

12V DC
Material: Aluminium / Polycarbonate (PC)

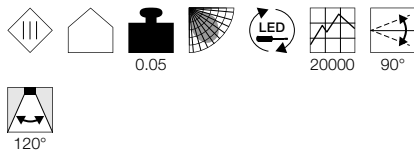

Dimensioned drawing

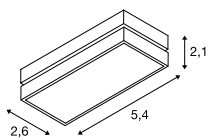

M-TRACK
Spot



• Spots easy to move due to magnetic holder

Product details

12V DC
Material: Aluminium / Polycarbonate (PC)

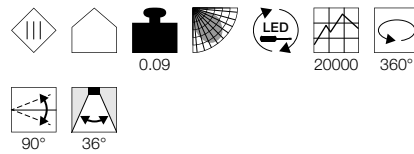

Dimensioned drawing

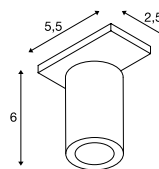

Variant	Item no.
260lm 3000K CRI>80 ■ black	188550

Variant	Item no.
400lm 3000K CRI>80 ■ black	188530



188550 430

M-TRACK
Track

Rated voltage	12V DC
Max. perm. voltage	12V DC
Max. perm. current	9A
Material	Aluminium
Colour	black
Length	200 cm
Width	3 cm
Height	1.4 cm
Weight	1.05 kg

Item no.	188500
-----------------	---------------

Feed-in

ABS / polycarbonate (PC)
L: 3.6 cm W: 3 cm H: 1.6 cm
Weight: 0.01 kg
1 pc.



Variant	Item no.
■ black	188510

End cap

ABS / polycarbonate (PC)
L: 3 cm W: 1.4 cm H: 0.5 cm
Weight: 0.01 kg
1 pc.



Variant	Item no.
■ black	188520

Recommended accessories

LED power supply, 12V DC | 12W
Item no. 470507

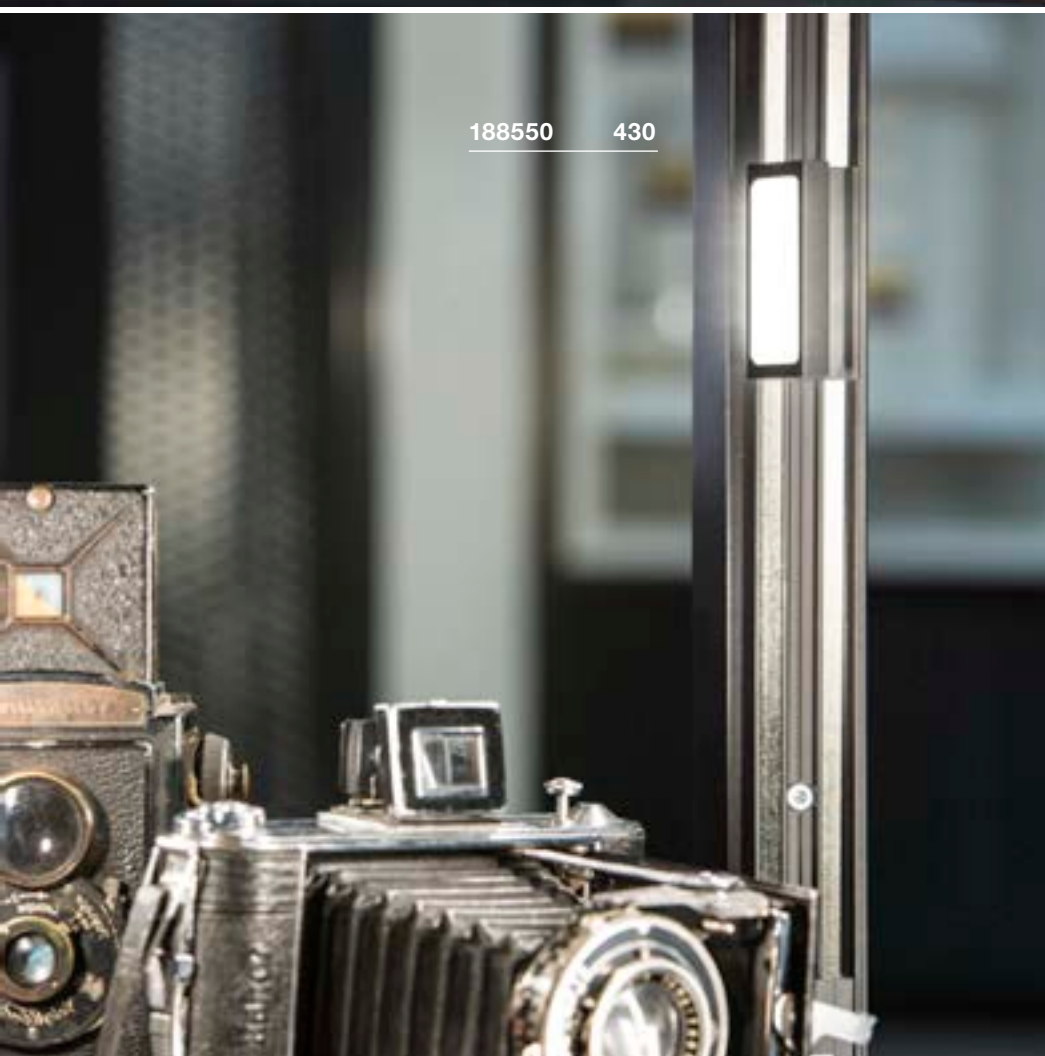

188550 430



SOLO 90°
GLU-TRAX®, QR-C51

C-A+ Range A++-E

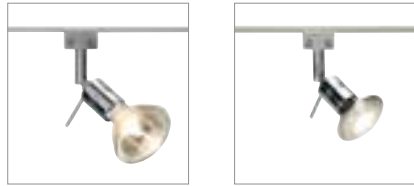

POWER-LED SPOT
GLU-TRAX®

A-A++ Range A++-E



Product details

12V ~50Hz
Material: Brass

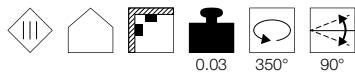

0.03 350° 90°

Product details

12V ~50/60Hz
Material: Aluminium / Polycarbonate (PC)



0.04 30000 360°



180° 25°

Dimensioned drawing

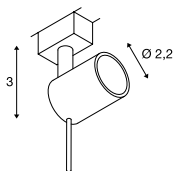

Dimensioned drawing

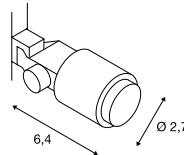

Note

Only operate with a conventional transformer.

Recommended lamp

GU5.3 5W 36°
2700K 345lm EEL=A+
6kWh/1000h
Item no. 551862



LED GU5.3 5.5W 36°
2700K 450lm EEL=A+
7kWh/1000h
Item no. 1001574



Lamp details

max. 35W QR-C51

Variant	Item no.
GU5.3 QR-C51	
■ chrome	186272

Variant	Item no.
55lm 3000K CRI>80	
■ grey	186042

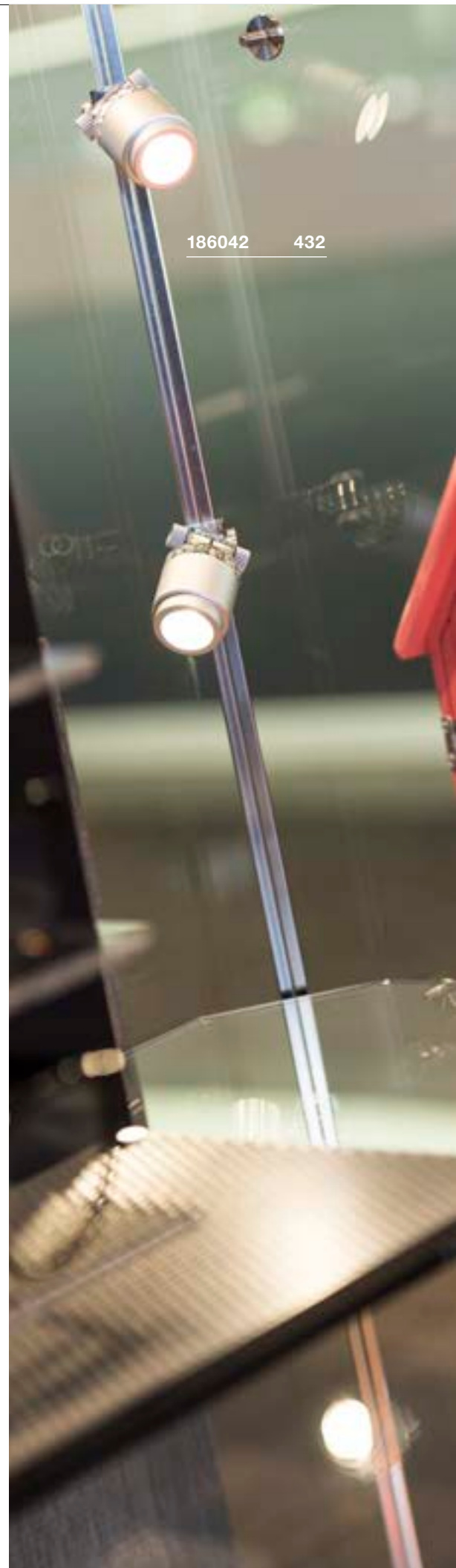



186042 432



GLU-TRAX®
Track, 1.5m

Rated voltage	12V AC
Max. perm. current	20 A
Feed-in capability	no
Material	Polycarbonate (PC)
Colour	transparent
Length	150 cm
Width	1 cm
Height	0.5 cm
Weight	0.2 kg
Item no.	186015

Note Simple installation using clips or by gluing together

ROBOT QR-C51 lamp holder	
Steel / Plastic L: 3 cm W: 2.2 cm H: 3 cm Weight: 0.02 kg 1 pc.	
Variant	Item no.
■ chrome	186762

Double-sided adhesive tape	
L: 300 cm W: 0.9 cm 1 pc.	
Variant	Item no.
	220000

Flexible long connector	
20A max. Steel L: 7.3 cm W: 1.4 cm H: 0.8 cm Weight: 0.02 kg 1 pc.	
Variant	Item no.
■ grey	186772

Mounting clips, 10 pieces	
Plastic PC Ø: 1.7 cm H: 0.8 cm 10 pc.	
Variant	Item no.
	186020

Feed-in cable/long connector	
20A max. Steel / Plastic L: 1.5 cm W: 1.4 cm H: 0.8 cm Weight: 0.01 kg 1 pc.	
Variant	Item no.
■ grey	186952

DEEP ROOTED.

RECESSED FITTINGS RADIATE AN IMPRESSION.

Be it broad-beamed, flooded, static or swivelling: Recessed fittings are the core element of many lighting concepts, and provide a good alternative to freely suspended luminaires. You can adapt to any ambience and give yourself a great deal of furnishing freedom.

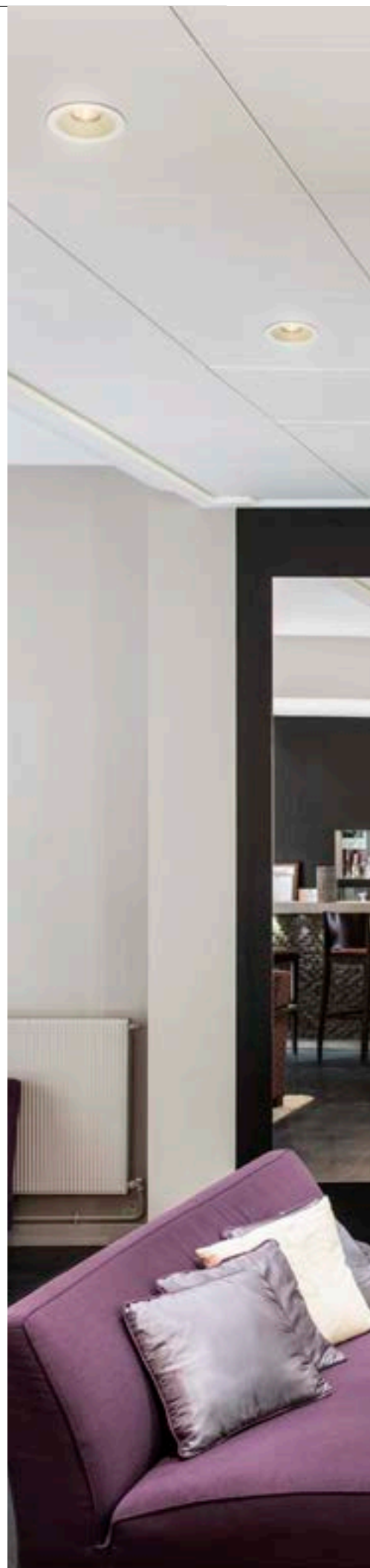



1001841 + 1001851 477

112242 450



OUR PROMISE OF QUALITY

INNOVATION AND DEVELOPMENT

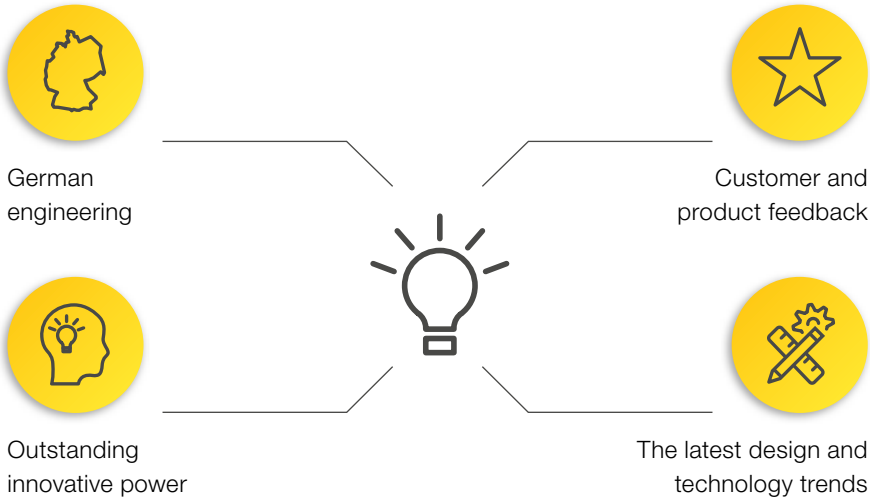

MANUFACTURING

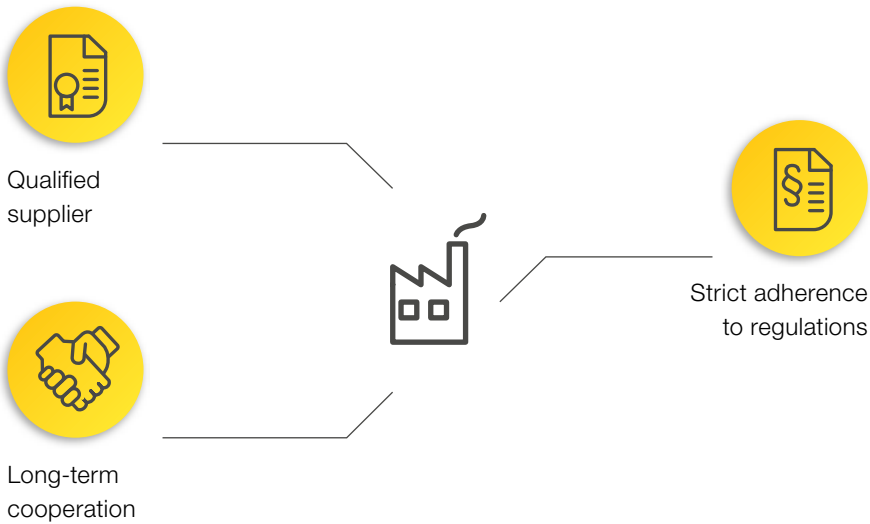

QUALITY ASSURANCE

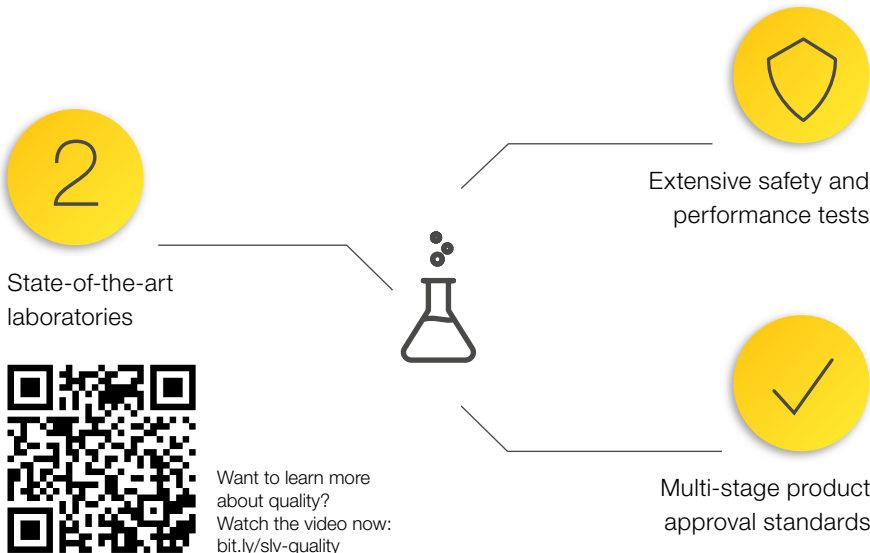

Want to learn more about quality? Watch the video now: bit.ly/slv-quality









































































RECESSED FITTINGS

 NEW	 LED	 LED	 LED	 LED	 LED	 LED	 LED	 LED	 LED	 LED
440	441	441	441	441	443	443	443	443	444	444
 LED	 LED	 NEW	 NEW	 LED	 LED	 LED	 LED	 LED	 LED	 LED
444	444	445	445	445	446	446	447	447	447	447
 LED	 LED	 LED	 LED	 LED	 LED	 LED	 LED	 LED	 LED	 LED
448	449	450	450	450	451	451	452	453	453	453
 LED	 LED	 LED	 LED	 LED	 LED	 LED	 LED	 LED	 LED	 LED
453	454	455	455	455	455	457	457	457	457	457
 LED	 LED	 LED	 LED	 LED	 LED	 LED	 LED	 LED	 LED	 LED
458	458	459	460	460	460	461	461	461	462	462
 LED	 LED	 NEW	 LED	 LED	 LED	 LED	 LED	 LED	 LED	 LED
462	463	464	465	465	465	466	466	466	467	467
 LED	 LED	 LED	 LED	 LED	 LED	 LED	 LED	 LED	 LED	 LED
467	469	469	469	469	471	471	471	471	472	472
 LED	 LED	 LED	 LED	 LED	 LED	 LED	 LED	 LED	 LED	 LED
473	473	474	474	474	474	476	476	476	476	476
 LED	 LED	 LED	 LED	 LED	 LED	 LED	 LED	 LED	 LED	 LED
477	477	477	479	479	479	479	482	482	482	482
 LED	 LED	 LED	 LED	 LED	 LED	 LED	 LED	 LED	 LED	 LED
483	483	484	484	485	485	485	486	486	487	487
 LED	 LED	 LED	 LED	 LED	 LED	 LED	 LED	 LED	 LED	 LED
487	487	488	488	488	489	489	489	490	490	490

1001907 520

1001973 514



 491	 491	 492	 492	 493	 494	 495	 495
 495	 496	 496	 496	 497	 497	 498	 498
 498	 499	 499	 500	 500	 501	 502	 503
 503	 503	 504	 505	 506	 507	 508	 508
 508	 509	 510	 510	 510	 511	 511	 511
 512	 513	 513	 513	 514	 515	 515	 517
 517	 518	 519	 519	 519	 520	 520	 520
 521	 522	 523	 523	 524	 524	 524	 525
 525	 525	 527	 527	 527			



1002979 440



151952 441

NOTAPO
WL

A-A++ Range A++-E

LED
INSIDE

NEW



Product details

700mA | 2.2W
Material: Aluminium
Product dimensions:
W: 3.6 cm H: 10.5 cm D: 3.8 cm



Note

When connecting several luminaires, make sure that they are connected in series! Open cable end

Recommended accessories

- LED driver 700mA | 3W incl. strain relief
Item no. 464200
- Installation frame
Item no. 1002981



Variant	Item no.
6lm 3000K CRI>90 W: 3.6 cm H:10.5 cm D: 3.8 cm 0.07 kg <input type="checkbox"/> matt white	1002979
6lm 3000K CRI>90 W: 3.6 cm H:18 cm D: 3.8 cm 0.1 kg <input type="checkbox"/> matt white	1002980



DOWNUNDER PUR 80 EL



DOWNUNDER PUR 120 EL



DOWNUNDER PUR 150 EL



Product details

350mA | 3.6W
Material: Aluminium / Steel



Product details

350mA | 3.6W
Material: Aluminium / Steel



Product details

500mA | 5.2W
Material: Aluminium / Steel



Dimensioned drawing

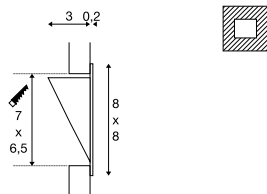

Dimensioned drawing

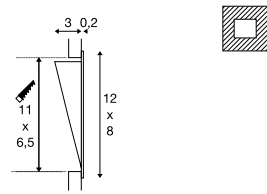

Dimensioned drawing

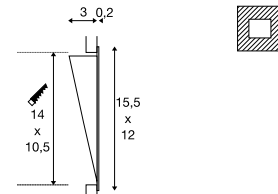

Note

When connecting several luminaires, make sure that they are connected in series!
Material thickness, mounting surface: 15 mm max.
The luminaires can be combined with the VALETO® system by using different drivers.
AMP plug incl. / driver excl.

Note

When connecting several luminaires, make sure that they are connected in series!
Material thickness, mounting surface: 15 mm max.
The luminaires can be combined with the VALETO® system by using different drivers.
AMP plug incl. / driver excl.

Note

When connecting several luminaires, make sure that they are connected in series!
Material thickness, mounting surface: 15 mm max.
The luminaires can be combined with the VALETO® system by using different drivers.
AMP plug incl. / driver excl.

Recommended accessories

- LED driver 350mA | 10W
Item no. 464140
- LED driver 350mA | 9W
Item no. 464109
- Installation frame
Item no. 151960

Recommended accessories

- LED driver 15W | 350mA with strain relief
Item no. 464143
- LED driver 350mA | 9W
Item no. 464109
- Installation frame
Item no. 151961

Recommended accessories

- LED driver 500mA | 15W dimmable
Item no. 464144
- LED driver 500mA | 9W
Item no. 464091
- Installation frame
Item no. 151962

Variant	Item no.
180lm 3000K CRI>80 <input type="checkbox"/> white	151950

Variant	Item no.
160lm 3000K CRI>80 <input type="checkbox"/> white	151951

Variant	Item no.
230lm 3000K CRI>80 <input type="checkbox"/> white	151952

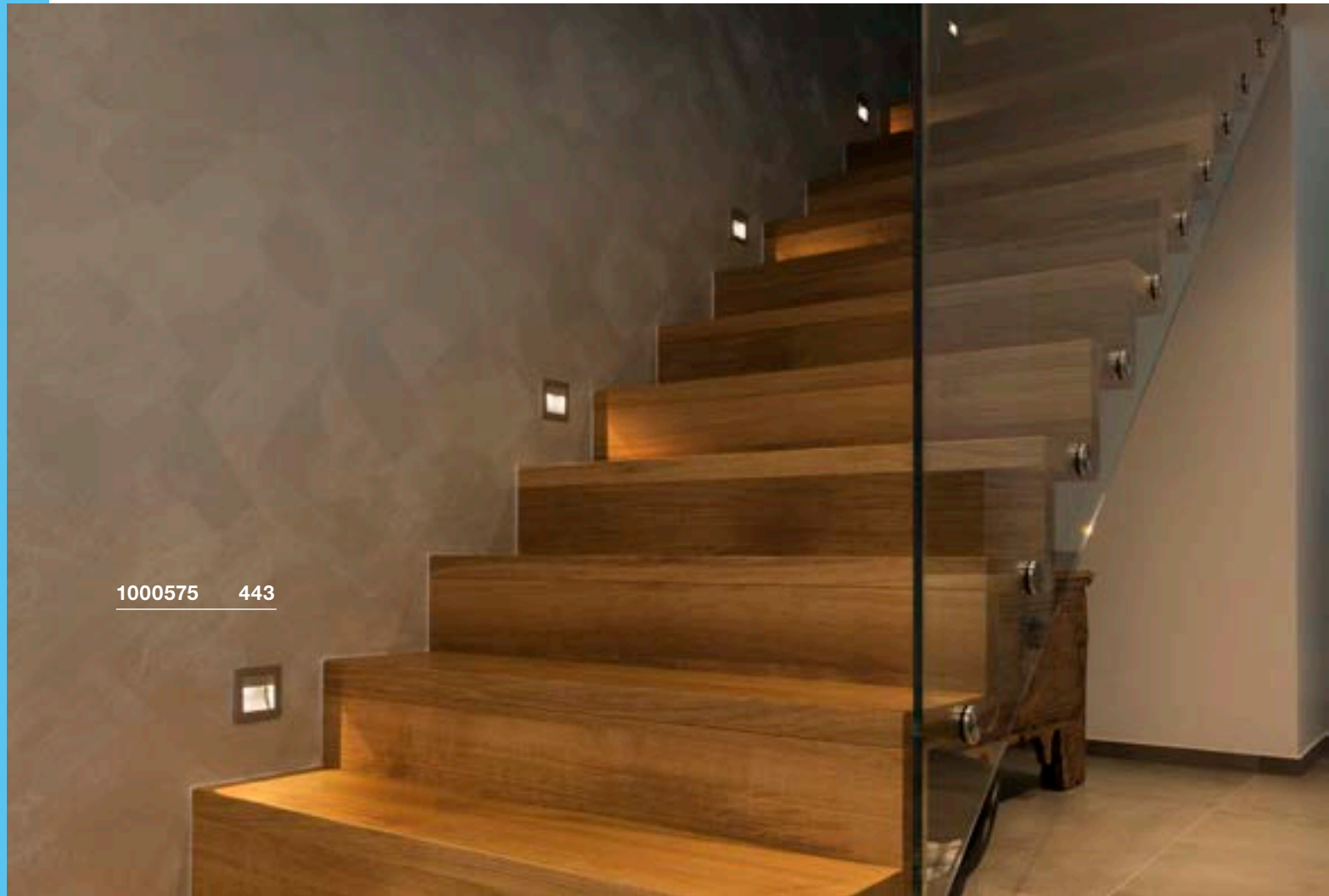

1000575 443

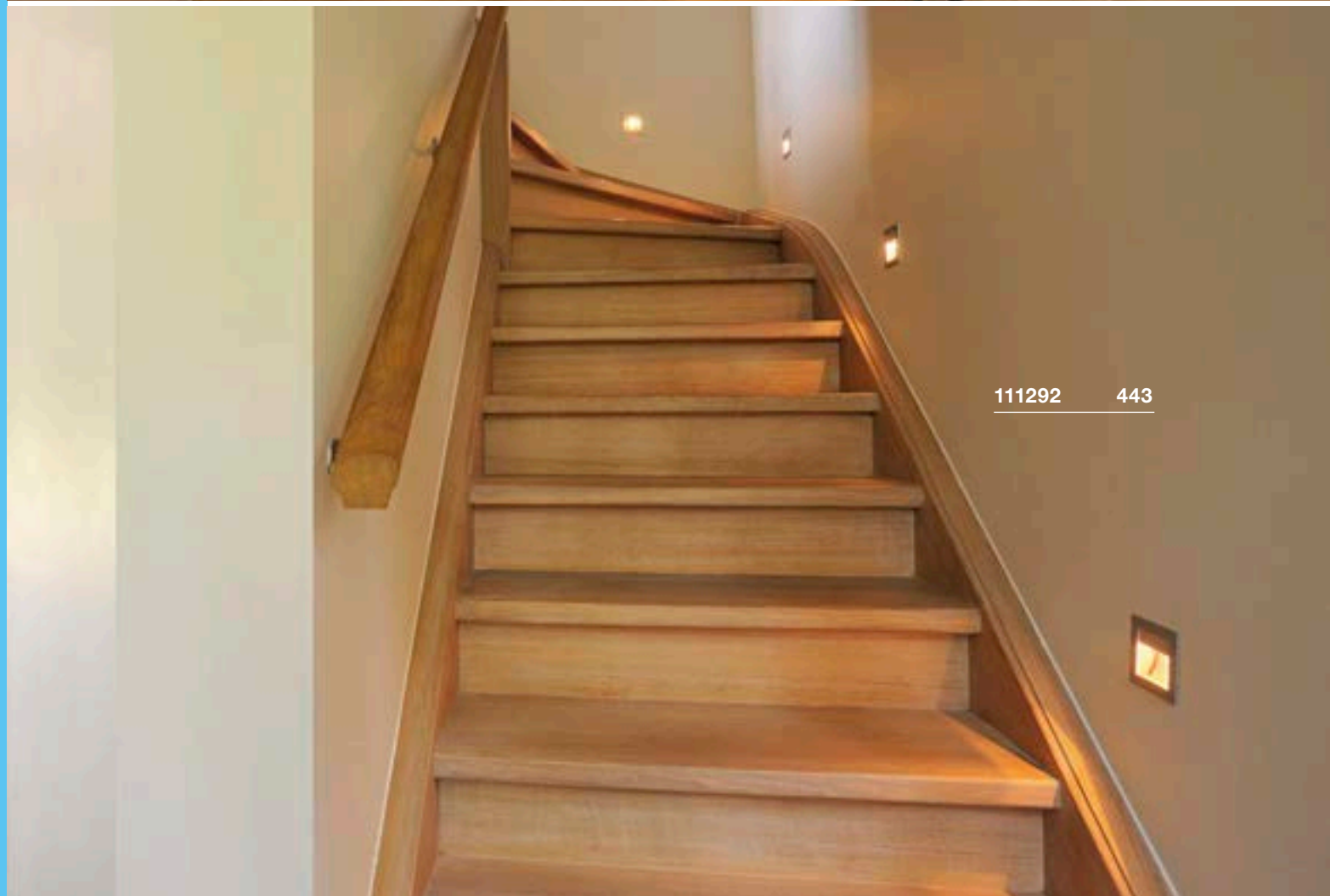

111292 443

FLAT FRAME CURVE
EL, QT9



Product details

12V ~50/60Hz
Material: Aluminium

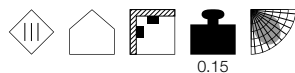

Dimensioned drawing

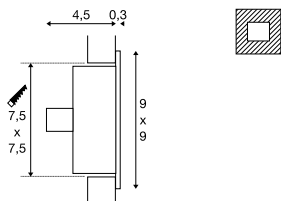

Note

Material thickness, mounting surface:
10-25 mm max.
Line drawing on left with installation box

Recommended accessories

- Transformer 12V AC | 60VA
Item no. 461060
- Installation box
Item no. 112781
- Flush-mounted frame
Item no. 112780

Lamp details

max. 20W QT9

Variant	Item no.
G4 QT9	
<input type="checkbox"/> matt white	112771
G4 QT9	
<input checked="" type="checkbox"/> grey	112772

FRAME CURVE
EL, HV



Product details

100-277V ~50/60Hz | 350mA
Total consumption: 3.1W
Material: Aluminium



Dimensioned drawing

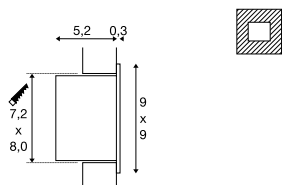

Note

Material thickness, mounting surface: 10-30 mm

Recommended accessories

- Installation box
Item no. 112781
- Flush-mounted frame
Item no. 112780

Variant	Item no.
100lm 2700K CRI>80	
<input type="checkbox"/> white	1000574
100lm 2700K CRI>80	
<input checked="" type="checkbox"/> grey	1000575

FRAME CURVE
EL



Product details

350mA | 1W
Material: Aluminium



Dimensioned drawing

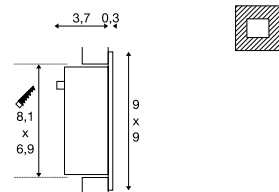

Note

Material thickness, mounting surface:
10-30 mm max.
When connecting several luminaires,
make sure that they are connected in series!
The luminaires can be combined with the
VALETO® system by using different drivers.
Including AMP plug / excluding driver

Recommended accessories

- LED driver 350mA | 3W
Item no. 464107
- Installation box
Item no. 112781
- Flush-mounted frame
Item no. 112780
- Multiway connector with 3 outputs
Item no. 111850

Variant	Item no.
60lm 4000K CRI>80	
<input checked="" type="checkbox"/> grey	111290
60lm 3000K CRI>80	
<input checked="" type="checkbox"/> grey	111292
60lm 4000K CRI>80	
<input type="checkbox"/> matt white	113290
60lm 3000K CRI>80	
<input type="checkbox"/> matt white	113292

FLAT FRAME BASIC EL, QT9

C-A+ Range A++-E

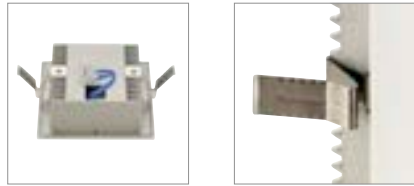

FRAME BASIC EL, HV

A-A++ Range A++-E

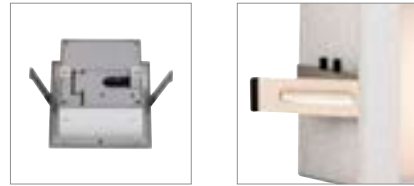

FRAME BASIC EL

A-A++ Range A++-E



• Use of slides and films is possible

Product details

12V ~50/60Hz
Material: Aluminium / Glass

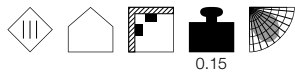

0.15

Product details

100-277V ~50/60Hz | 350mA
Total consumption: 3.1W
Material: Aluminium

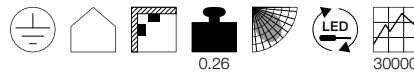

0.26

30000



250

Product details

350mA | 1W
Material: Aluminium / Glass

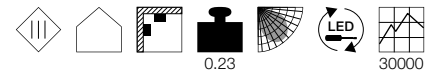

0.23

30000

Dimensioned drawing

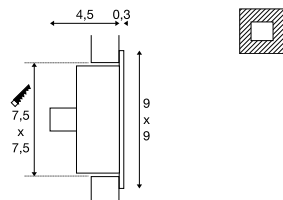

Note

Material thickness, mounting surface:
10-25 mm max.

Dimensioned drawing

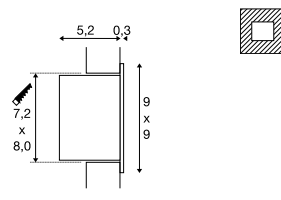

Note

Material thickness, mounting surface: 10-30 mm

Dimensioned drawing

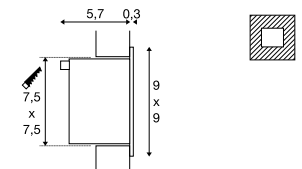

Note

Material thickness, mounting surface:
10-30 mm max.
When connecting several luminaires, make
sure that they are connected in series!
The luminaires can be combined with the
VALETO® system by using different drivers.
Including AMP plug / excluding driver
Material thickness, mounting surface: 10-30 mm

Recommended accessories

- Transformer 12V AC | 60VA
Item no. 461060
- Installation box
Item no. 112781
- Flush-mounted frame
Item no. 112780



Recommended accessories

- Flush-mounted frame
Item no. 112780
- Installation box
Item no. 112781



Recommended accessories

- LED driver 350mA | 3W
Item no. 464107
- Flush-mounted frame
Item no. 112780
- Installation box
Item no. 112781
- Multiway connector with 3 outputs
Item no. 111850



Lamp details

max. 20W QT9

Variant	Item no.
G4 QT9	
<input type="checkbox"/> matt white	112731
G4 QT9	
<input checked="" type="checkbox"/> grey	112732

Variant	Item no.
140lm 2700K CRI>80	
<input type="checkbox"/> white	1000576
140lm 2700K CRI>80	
<input checked="" type="checkbox"/> grey	1000577

Variant	Item no.
45lm 4000K CRI>80	
<input checked="" type="checkbox"/> grey	111260
40lm 3000K CRI>80	
<input checked="" type="checkbox"/> grey	111262
45lm 4000K CRI>80	
<input type="checkbox"/> matt white	113260
40lm 3000K CRI>80	
<input type="checkbox"/> matt white	113262



1002922 445

MOBALA
EL

A-A++ Range A++-E

LED INSIDE

NEW



Product details

100-240V ~50/60Hz | 24V DC
Total consumption: 1.3W
Material: Aluminium



Dimensioned drawing

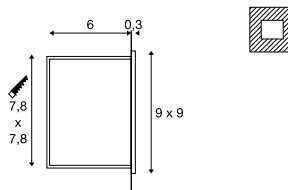

Recommended accessories

- Installation box
Item no. 1002983
- Installation frame
Item no. 1002984

Variant	Item no.
14lm 3000K CRI>80 □ matt white	1002982

WORD
EL

A-A++ Range A++-E

LED INSIDE

NEW



Product details

350mA | 1.1W
Material: Steel



Dimensioned drawing

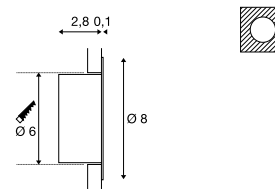

Note

When connecting several luminaires, make sure that they are connected in series!
The item is suitable for installation in flush-mounted and cavity wall boxes for switches/sockets.
Open cable end

Recommended accessories

- LED driver 350mA | 9W
Item no. 464109

Variant	Item no.
50lm 3000K CRI>80 □ matt white	1002922

BEDSIDE
EL, left

A-A++ Range A++-E



- "Dip-it" switching when swivelled out
- With blue orientation light when switched off
- Left version

Product details

700mA | 3W
Material: Aluminium

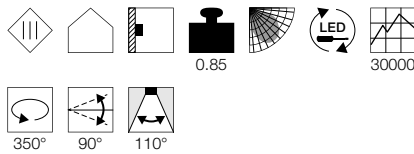

Dimensioned drawing

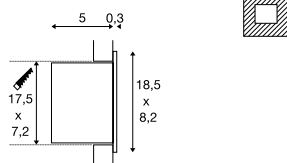

Note

Not suitable for series connection.
Only for operation with a 3W driver (464200).
Material thickness, mounting surface: 20 mm max.

Recommended accessories

LED driver 700mA | 3W incl. strain relief
Item no. 464200



Installation box
Item no. 146260



Variant	Item no.
110lm 3000K CRI>80	
■ grey	146242

BEDSIDE
EL, right

A-A++ Range A++-E

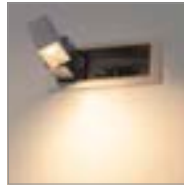

- "Dip-it" switching when swivelled out
- With blue orientation light when switched off
- Right version

Product details

700mA | 3W
Material: Aluminium

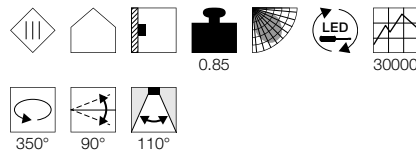

Dimensioned drawing

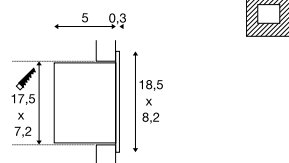

Note

Not suitable for series connection.
Only for operation with a 3W driver (464200).
Material thickness, mounting surface: 20 mm max.

Recommended accessories

LED driver 700mA | 3W incl. strain relief
Item no. 464200



Installation box
Item no. 146260



Variant	Item no.
110lm 3000K CRI>80	
■ grey	146252



146242 446

146242 446



152381 447

KARPO 30
EL



A-A++ Range A++-E



- Premium LED with CRI>90

Product details

500mA | 7.5W
Material: Aluminium / Steel

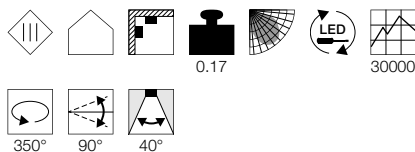

Dimensioned drawing

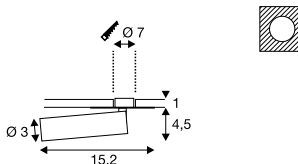

Note

Material thickness, mounting surface: 12 mm max.
When connecting several luminaires, make sure that they are connected in series!
When using different drivers, the luminaires can be combined with the VALETO® system.
Driver excl.

Recommended accessories

□ LED driver 500mA | 9W
Item no. 464091



Variant	Item no.
450lm 3000K CRI>90	
■ black	152380
470lm 3000K CRI>90	
□ white	152381

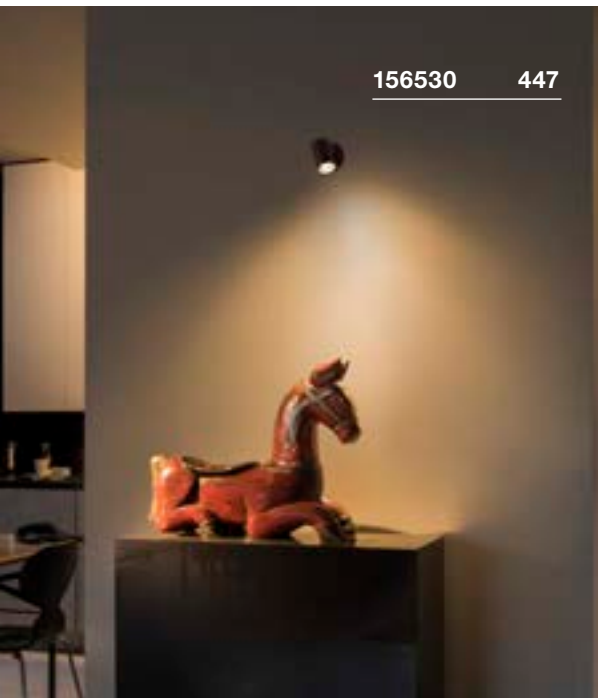

156530 447

HELIA
EL



A-A++ Range A++-E



- Premium LED with CRI>90
- Shallow installation depth

Product details

500mA | 9W
Material: Aluminium

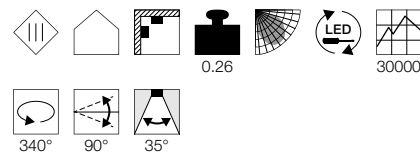

Dimensioned drawing

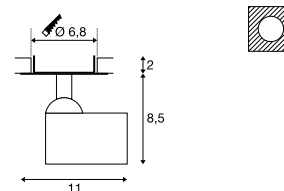

Note

Material thickness, mounting surface: 15 mm

Recommended accessories

□ LED driver 500mA | 9W
Item no. 464091



Variant	Item no.
700lm 3000K CRI>90	
■ black	156530
800lm 3000K CRI>90	
□ white	156531

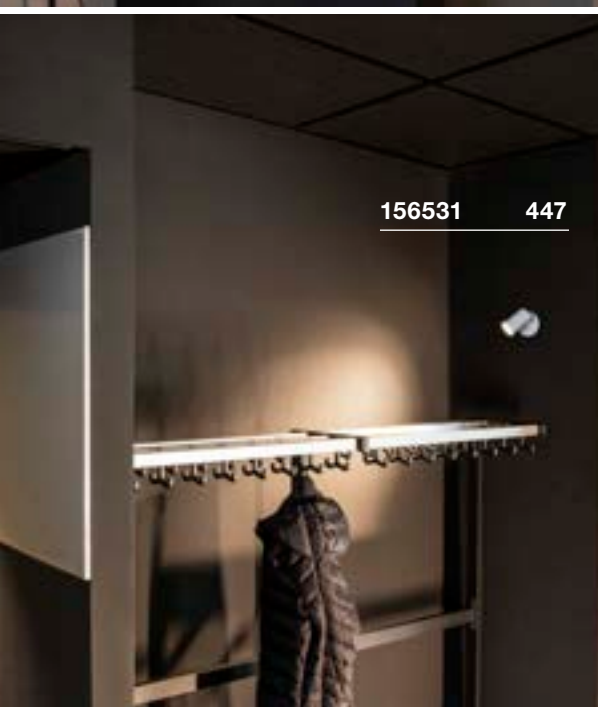

156531 447

LIGHTPOINT
EL

A-A++ Range
A++-E 



1001156 448

Product details



350mA | 1W
Material: Aluminium / Polymethylacrylate (PMMA)

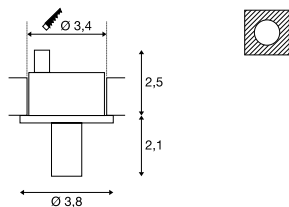

Dimensioned drawing



Recommended accessories

- Multiway connector with 3 outputs
Item no. 111850 
- LED driver 350mA | 3W
Item no. 464107 

Variant	Item no.
100lm 3000K CRI>80 □ white	1001156
100lm 3000K CRI>80 ■ chrome	1001155

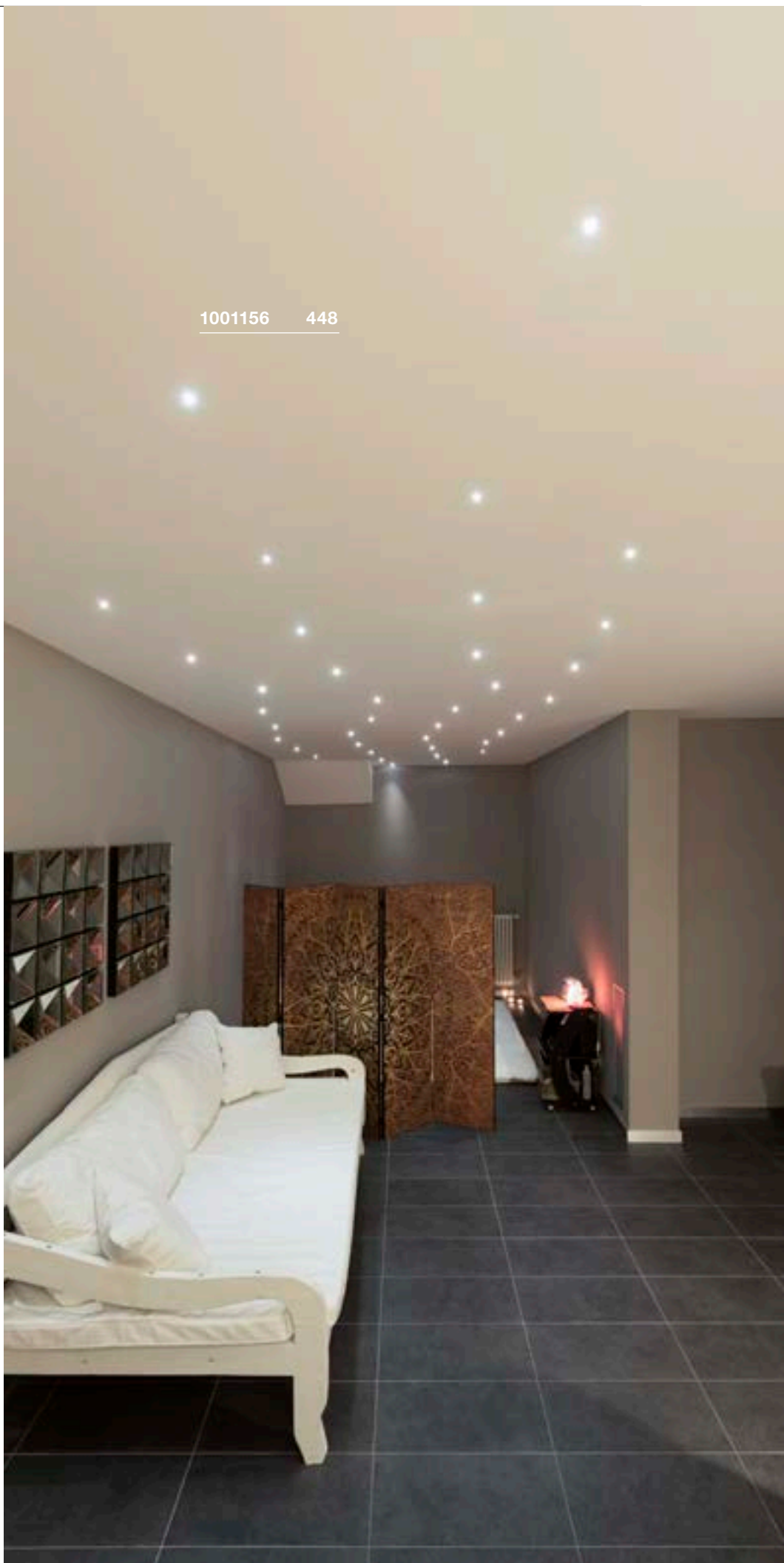



1002120 449

CRYSTAL
EL, TRIACA-A++ Range
A++-ELED
INSIDE

- Premium LED with CRI>90
- Dim to Warm (1800-3000K)

Product details

220-240V ~50/60Hz | 350mA
 Total consumption: 7.3W
 Material: Aluminium / Glass
 Dimmable: Triac C, Triac L

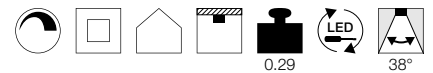

Dimensioned drawing

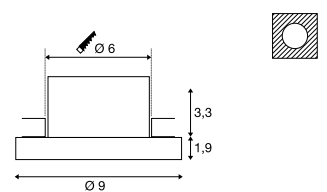

Note

Products supplied with clip springs. Leaf springs included with the product and can be exchanged
 Material thickness, mounting surface: 20 mm

An application video about
 Dim to Warm can be found at
<http://bit.ly/dim-to-warm>



Variant	Item no.
460lm 1800-3000K CRI>95 □ transparent	1002120

DEKLED
EL

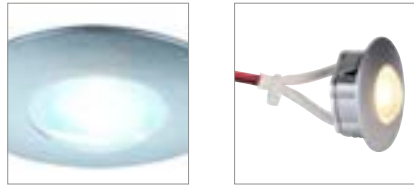

DL 126
EL

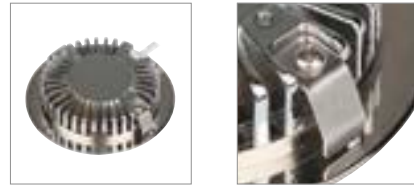

Product details

350mA | 1W
Material: Aluminium / Polycarbonate (PC)

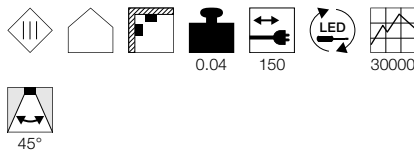

Dimensioned drawing

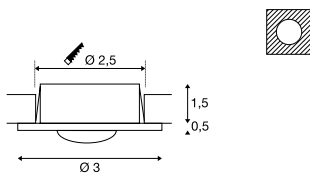

Product details

12V DC | 2.8W
Material: Aluminium / Plastic

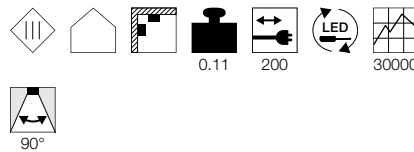

Dimensioned drawing

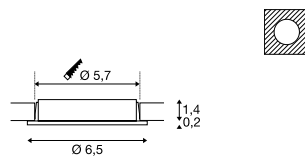

Recommended accessories

LED driver 320mA | 3W incl. strain relief
Item no. 464108



Recommended accessories

LED power supply, 12V DC | 12W
Item no. 470507



Variant	Item no.
60lm 4000K CRI>80 grey	112240
60lm 3000K CRI>80 grey	112242

Variant	Item no.
160lm 3000K CRI>80 white	112221
160lm 3000K CRI>80 chrome	112222
160lm 3000K CRI>80 matt grey	112225
160lm 2700K CRI>80 white	112161
160lm 2700K CRI>80 chrome	112162
160lm 2700K CRI>80 matt grey	112165

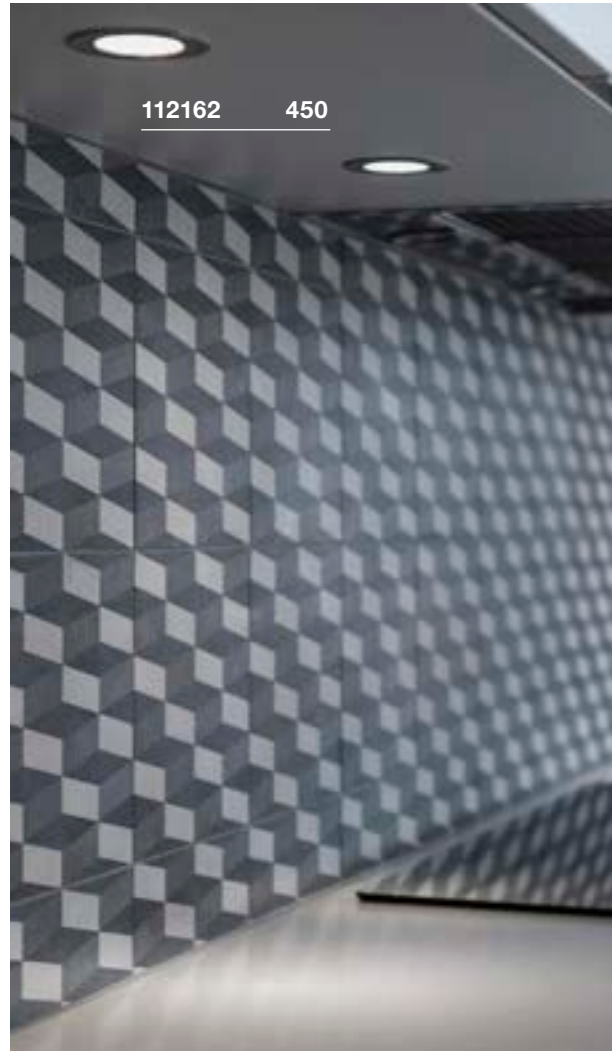
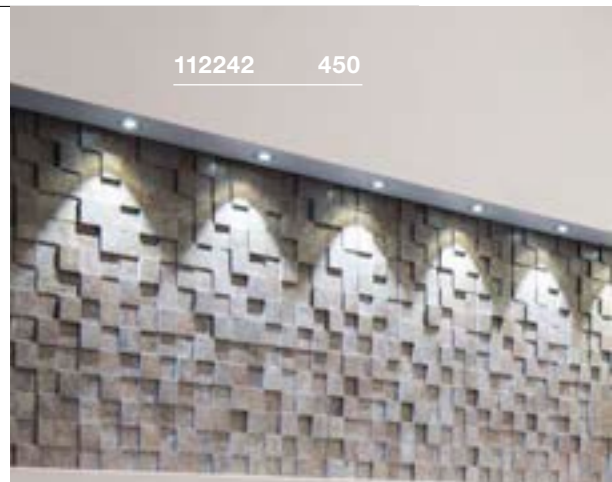



112161 450

FRAME BASIC SET EL

A-A++ Range A++-E

LED INSIDE

Home icon with plus sign



Product details

220-240V ~50/60Hz | 350mA
 Total consumption: 8.6W
 Material: Aluminium / Acrylic

Icons: Square, House, Hatched, Knob, Fan, LED, Graph, and a value of 56000.



Dimensioned drawing

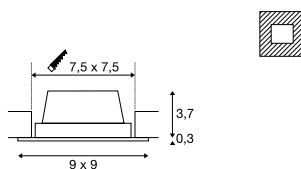

Note

Clip springs
 Material thickness, mounting surface: 20 mm max.



112720 451

INDI REC EL, QPAR51

E-A++ Range A++-E

NEW COLOR

Home icon with plus sign



Product details

220-240V ~50/60Hz
 Material: Aluminium / Steel

Icons: Square, House, Hatched, Knob, Fan, LED, Graph, and beam spread angles of 30° and 30°.

Dimensioned drawing

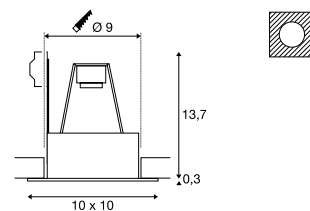

Note

Material thickness, mounting surface: 25 mm

Recommended lamp

LED GU10 5.5W 38°
 2700K 400lm EEL=A+
 6kWh/1000h
 Item no. 1001030



LED GU10 7.2W 36°
 2700K 470lm EEL=A+
 8kWh/1000h
 Item no. 560552



Lamp details

max. 20W QPAR51

Variant	Item no.
445lm 3000K CRI>80	
■ matt black	112720
445lm 3000K CRI>80	
□ matt white	112721
445lm 3000K CRI>80	
■ matt aluminium	112726

Variant	Item no.
GU10 QPAR51	
■ matt black	1002857
GU10 QPAR51	
□ matt white	112471
GU10 QPAR51	
■ grey / black	112474

KAHOLO
EL, E27



- Can be equipped with a wide range of E27 lamps
- Height-adjustable socket

Product details

230V ~50Hz
Material: Aluminium / Steel

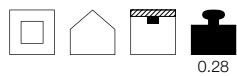

Dimensioned drawing

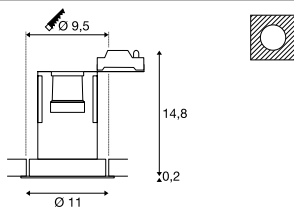

Note

Material thickness, mounting surface: 20 mm max.

Recommended lamp

LED E27 11.5W 240°
2700K 1060lm EEL=A+
12kWh/1000h | **3 Step-Dim**
Item no. **560432**



LED E27 9.5W 240°
2200-6700K 806lm EEL=A+
10kWh/1000h
Item no. **1001917**



Variant	Item no.
E27 PAR20	
■ black	1000906
E27 PAR20	
□ white	1000907
E27 PAR20	
■ matt aluminium	1000908

1000906 452

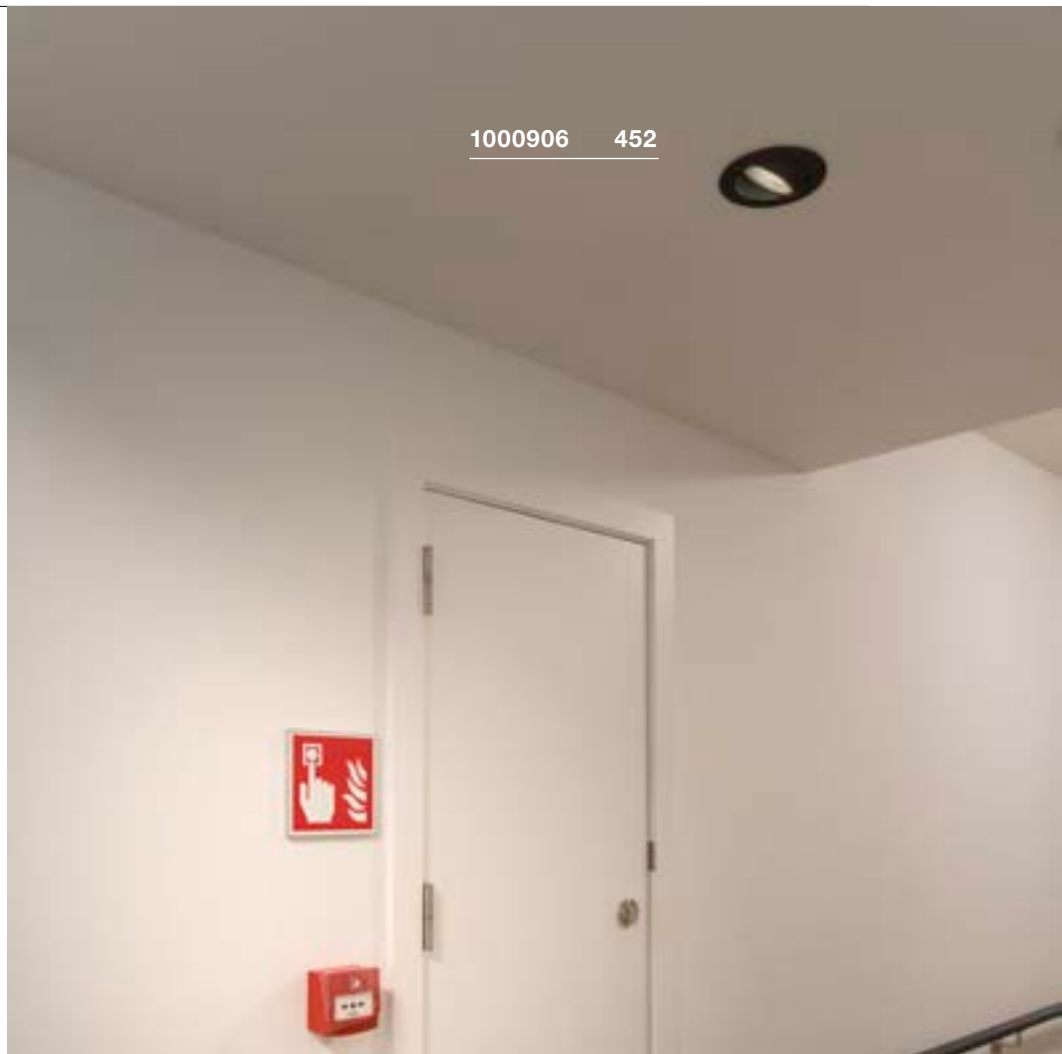

1000907 452





148070 453

PLASTRA
EL, round, QPAR51



E-A++ Range A++-E



- Flush installation possible
- Can be individually designed with colours, stickers and more

Product details

220-240V ~50/60Hz
Material: Plaster / Steel

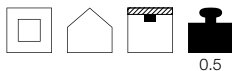

0.5

Dimensioned drawing

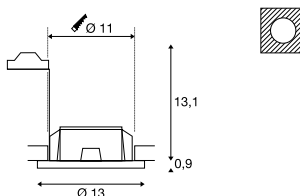

Note

Material thickness, mounting surface: 25 mm max.

Recommended lamp

GU10 5.5W 36°
2800K 420lm EEL=A+
6kWh/1000h
Item no. 1001217



LED GU10 5.1W 48°
2700-6500K 350lm EEL=A+
6kWh/1000h
Item no. 1001918



Lamp details

max. 35W QPAR51

Variant	Item no.
GU10 QPAR51	
<input type="checkbox"/> white	148070

PLASTRA
EL, square, QPAR51



E-A++ Range A++-E



- Flush installation possible
- Can be individually designed with colours, stickers and more

Product details

220-240V ~50/60Hz
Material: Plaster / Steel

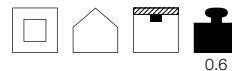

0.6

Dimensioned drawing

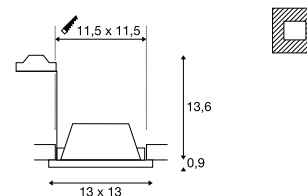

Note

Material thickness, mounting surface: 25 mm max.

Recommended lamp

LED GU10 5.5W 38°
2700K 400lm EEL=A+
6kWh/1000h
Item no. 1001030



LED GU10 7.2W 36°
2700K 470lm EEL=A+
8kWh/1000h
Item no. 560552



Lamp details

max. 35W QPAR51

Variant	Item no.
GU10 QPAR51	
<input type="checkbox"/> white	148071



148071 453

PIKA

EL, round, QPAR51, rigid

E-A++ Range
A++-E

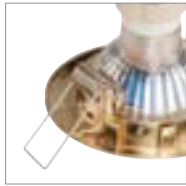

- 3-pole loop-in/loop-out (for through-wire)

Product details

230V ~50Hz
Material: Aluminium

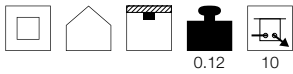

Dimensioned drawing

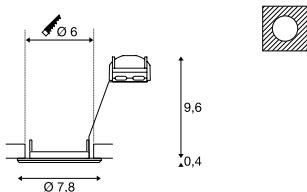

Note

Material thickness, mounting surface: 13 mm max.

Recommended lamp

GU10 5.5W 36°
2800K 420lm EEL=A+
6kWh/1000h
Item no. 1001217



LED GU10 5.5W 38°
2700K 400lm EEL=A+
6kWh/1000h
Item no. 1001030



Lamp details

max. 50W QPAR51

Variant	Item no.
GU10 QPAR51 white	1000714
GU10 QPAR51 chrome	1000715
GU10 QPAR51 brass	1000716
GU10 QPAR51 grey	1000717

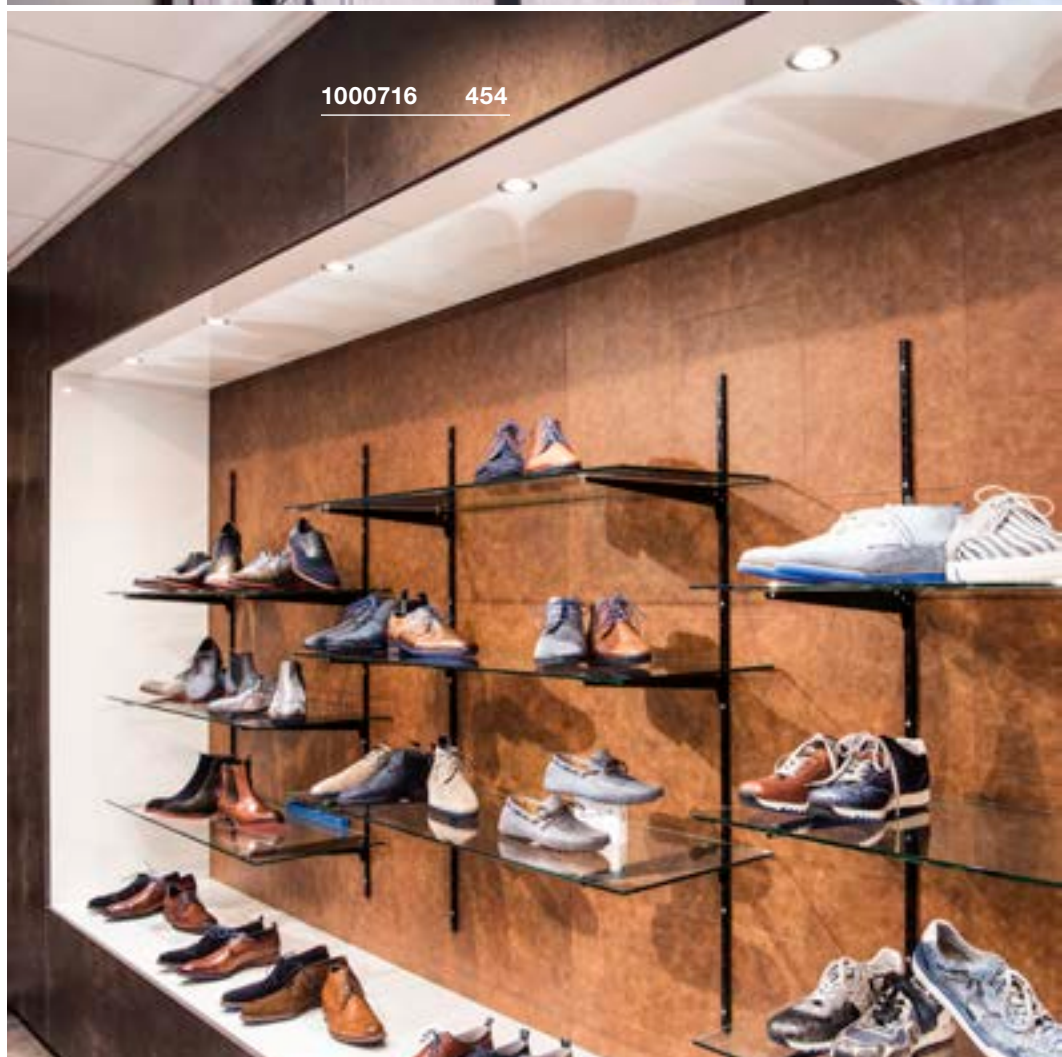

PIKA
EL, round, QPAR51



- 3-pole loop-in/loop-out (for through-wire)
- Lamp unit, can be tilted by 30°

Product details

230V ~50Hz
Material: Aluminium



Dimensioned drawing

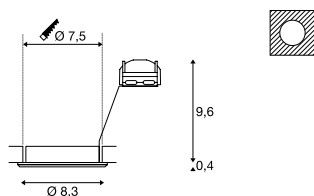

Note

Material thickness, mounting surface: 15 mm max.

Recommended lamp

LED GU10 5.5W 38°
2700K 400lm EEL=A+
6kWh/1000h

Item no. 1001030



LED GU10 7.2W 36°
2700K 470lm EEL=A+
8kWh/1000h

Item no. 560552



Lamp details

max. 50W QPAR51

Variant	Item no.
GU10 QPAR51	
□ white	1000718
GU10 QPAR51	
■ chrome	1000719
GU10 QPAR51	
■ brass	1000720
GU10 QPAR51	
■ grey	1000721

PIKA
EL, square, QPAR51, rigid



- 3-pole loop-in/loop-out (for through-wire)

Product details

230V ~50Hz
Material: Aluminium



Dimensioned drawing

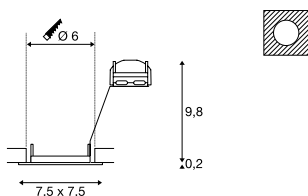

Note

Material thickness, mounting surface: 13 mm max.

Recommended lamp

LED GU10 5.5W 38°
2700K 400lm EEL=A+
6kWh/1000h

Item no. 1001030



LED GU10 7.2W 36°
2700K 470lm EEL=A+
8kWh/1000h

Item no. 560552



Lamp details

max. 50W QPAR51

Variant	Item no.
GU10 QPAR51	
□ white	1002204
GU10 QPAR51	
■ chrome	1002205
GU10 QPAR51	
■ brass	1002206
GU10 QPAR51	
■ grey	1002207

PIKA
EL, square, QPAR51, tilttable



- 3-pole loop-in/loop-out (for through-wire)
- Lamp unit, can be tilted by 30°

Product details

230V ~50Hz
Material: Aluminium

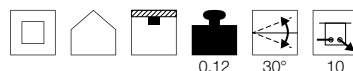

Dimensioned drawing

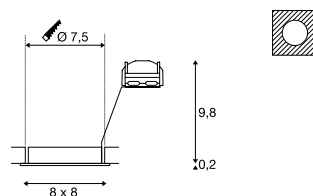

Note

Material thickness, mounting surface: 15 mm max.

Recommended lamp

GU10 5.5W 36°
2800K 420lm EEL=A+
6kWh/1000h

Item no. 1001217



LED GU10 5.1W 48°
2700-6500K 350lm EEL=A+
6kWh/1000h

Item no. 1001918



Lamp details

max. 50W QPAR51

Variant	Item no.
GU10 QPAR51	
□ white	1002208
GU10 QPAR51	
■ chrome	1002209
GU10 QPAR51	
■ brass	1002210
GU10 QPAR51	
■ grey	1002211

1003036 457



161301 457



161271 457

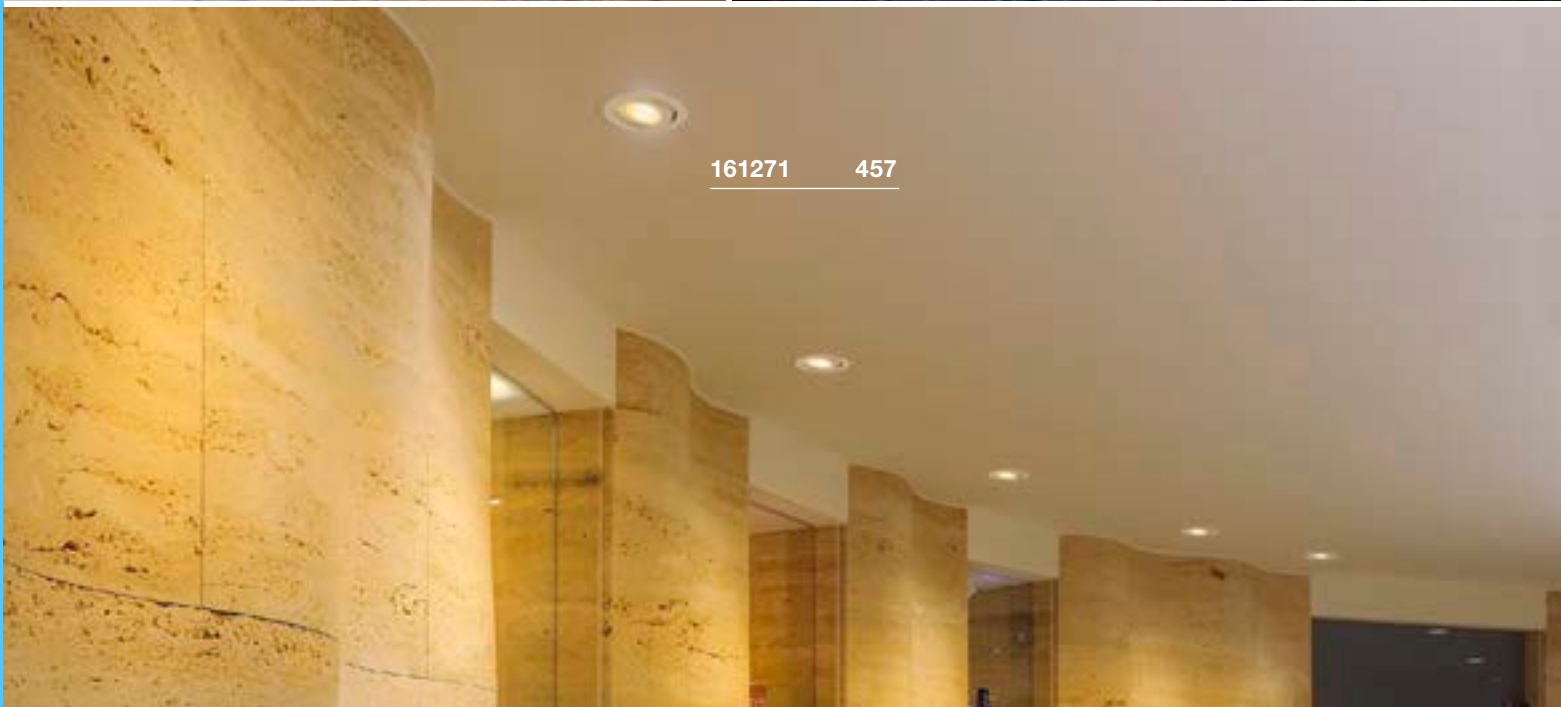

CONTONE®
EL, round/square, adjustable, TRIAC



- Premium LED with CRI>90
- Colour of light changed by dimming

Product details

220-240V ~50/60Hz | 350mA
Total consumption: 16W
Material: Aluminium
Dimmable: Triac C, Triac L

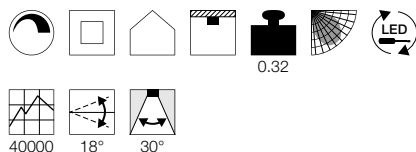

Dimensioned drawing

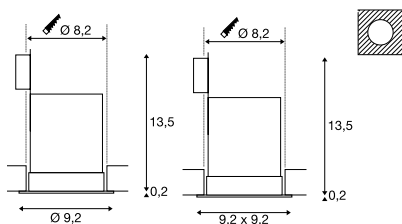

Note

Material thickness, mounting surface: 25 mm max.

An application video about Dim to Warm can be found at <http://bit.ly/dim-to-warm>



Variant	Item no.
890lm 2000K-3000K CRI>90	
○ white	161271
890lm 2000K-3000K CRI>90	
□ white	161281

CONTONE®
EL, round/square, rigid, TRIAC



- Premium LED with CRI>90
- Colour of light changed by dimming

Product details

220-240V ~50/60Hz | 350mA
Total consumption: 16W
Material: Aluminium
Dimmable: Triac C, Triac L

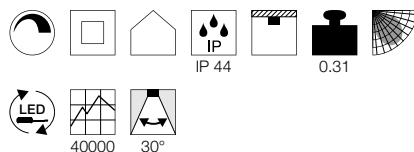

Dimensioned drawing

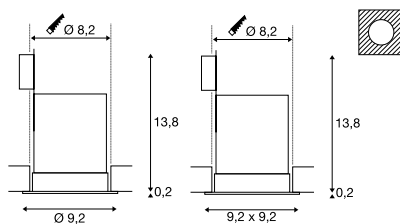

Note

Material thickness, mounting surface: 25 mm max.

An application video about Dim to Warm can be found at <http://bit.ly/dim-to-warm>



Variant	Item no.
890lm 2000K-3000K CRI>90	
○ white	161291
890lm 2000K-3000K CRI>90	
□ white	161301

DINGILO
EL, round, adjustable, TRIAC

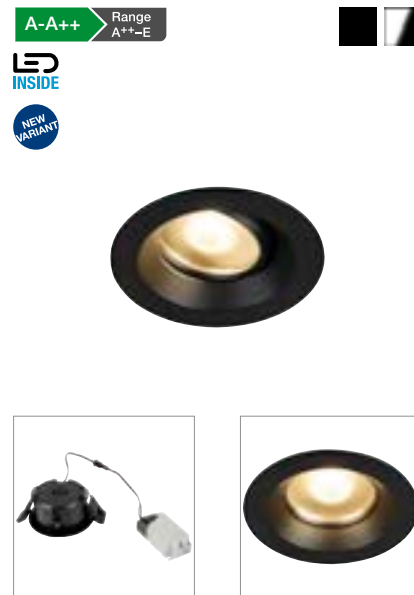

- Premium LED with CRI>90

Product details

100-277V ~50/60Hz | 200mA
Total consumption: 4.4W
Material: Aluminium / Plastic

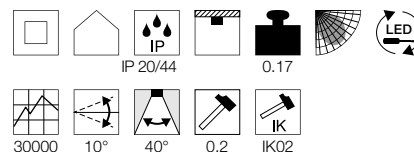

Dimensioned drawing

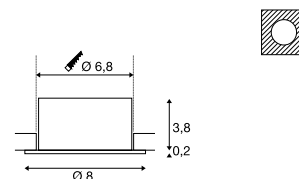

Note

Material thickness, mounting surface: 25 mm max.

Variant	Item no.
330lm 2700K CRI>90	
■ matt black / matt black	1003036
330lm 2700K CRI>90	
■ matt white / matt black	1003037
330lm 3000K CRI>90	
■ matt black / matt black	1003038
330lm 3000K CRI>90	
■ matt white / matt black	1003039

H-LIGHT
EL, round, TRIAC



- Close rotation-symmetrical distribution of light for accentuated lighting
- Generation of contoured light beams on vertical surfaces

Product details

220-240V ~50/60Hz | 500mA
Total consumption: 11W
Material: Aluminium
Dimmable: Triac C, Triac L

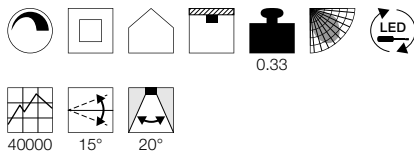

Dimensioned drawing

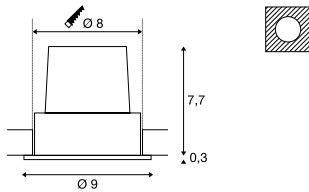

Note

Material thickness, mounting surface: 30 mm max.
Connection box incl.

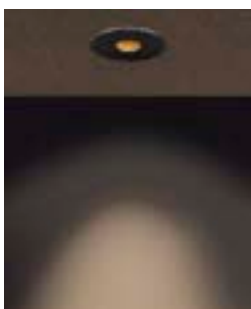

Variant	Item no.
265lm 2700K CRI>80 ■ matt black	114480
265lm 2700K CRI>80 □ matt white	114481

H-LIGHT
EL, oval, TRIAC



- Close asymmetrical distribution of light for accentuated lighting
- Generation of contoured light beams on vertical surfaces

Product details

220-240V ~50/60Hz | 500mA
Total consumption: 11W
Material: Aluminium
Dimmable: Triac C, Triac L

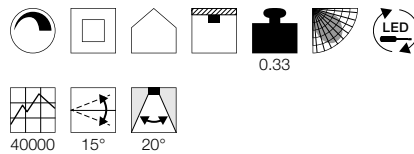

Dimensioned drawing

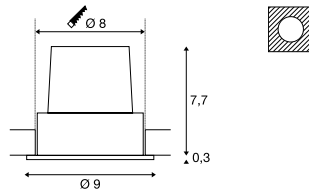

Note

Material thickness, mounting surface: 30 mm max.
Connection box incl.

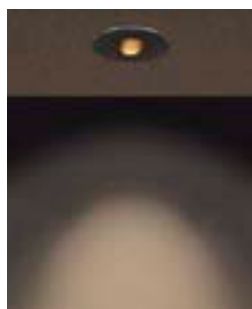

Variant	Item no.
395lm 2700K CRI>80 ■ matt black	114490
395lm 2700K CRI>80 □ matt white	114491

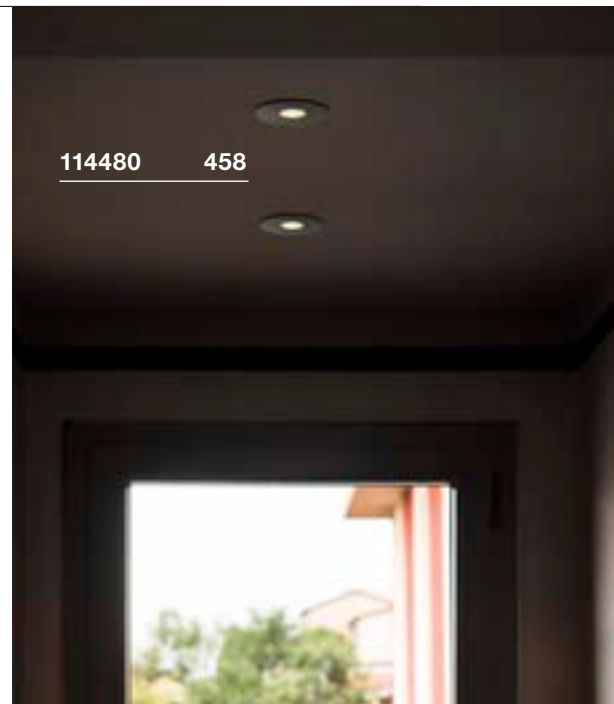

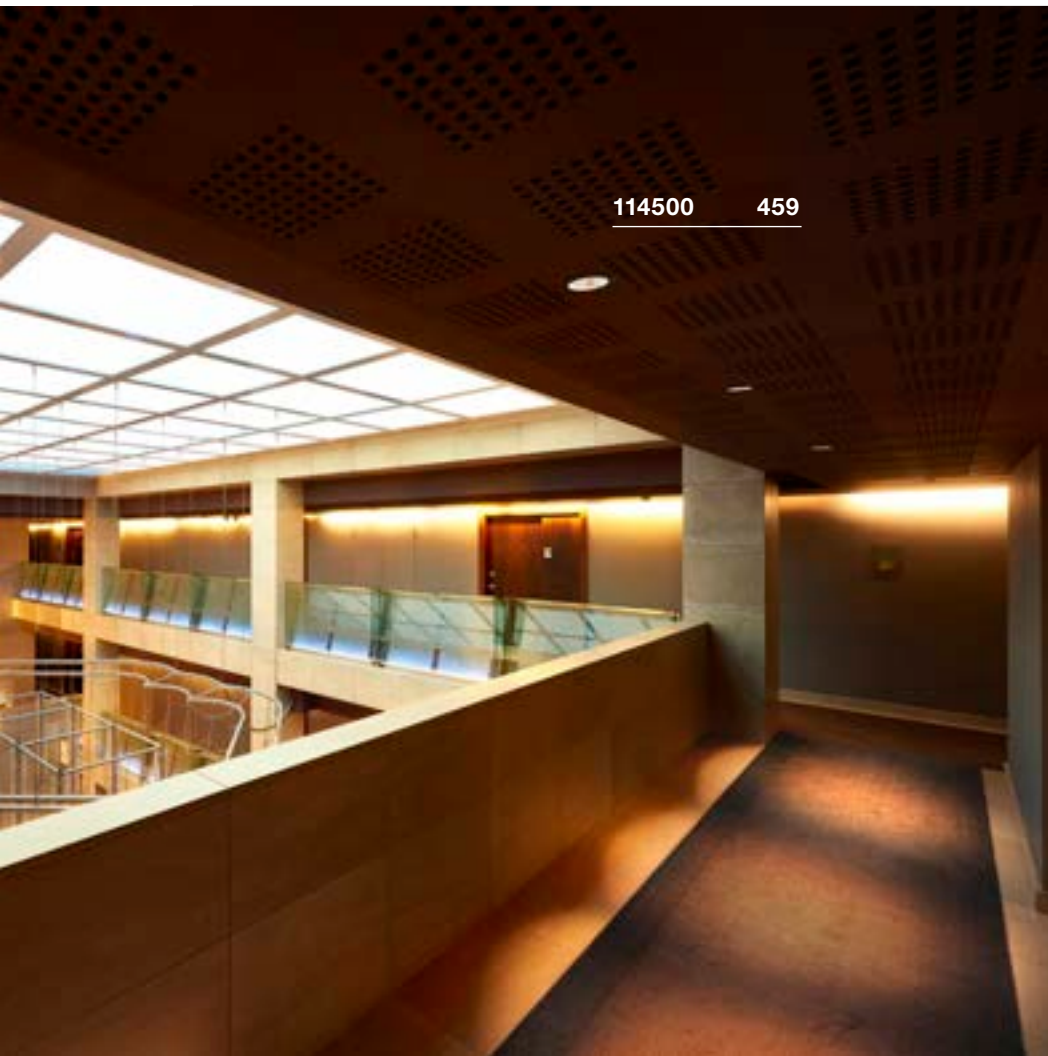

114500 459

H-LIGHT
EL, TRIAC

A-A++ Range A++-E



- Close rotation-symmetrical distribution of light for accentuated lighting
- Generation of contoured light beams on vertical surfaces

Product details

220-240V ~50/60Hz | 500mA
 Total consumption: 11W
 Material: Aluminium
 Dimmable: Triac C, Triac L

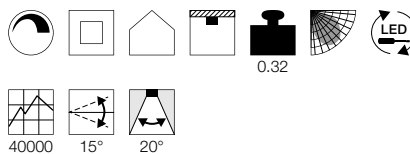

Dimensioned drawing

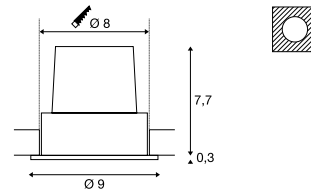

Note

Material thickness, mounting surface: 30 mm max.
 Connection box incl.

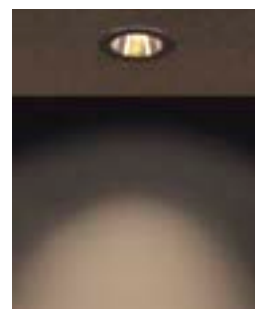

114500 459

Variant	Item no.
540lm 2700K CRI>80	
■ matt black	114500
540lm 2700K CRI>80	
□ matt white	114501

DOLIX OUT
EL, round, QR-C51

C-A+ Range A++-E



DOLIX OUT
EL, square, QR-C51

C-A+ Range A++-E



Product details

12V ~50Hz
Material: Aluminium / Glass

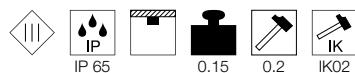

Product details

12V ~50Hz
Material: Aluminium / Glass

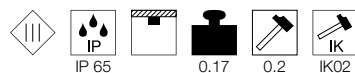

Dimensioned drawing

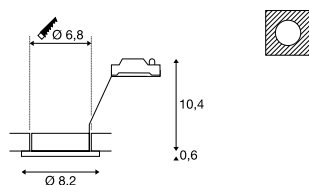

Dimensioned drawing

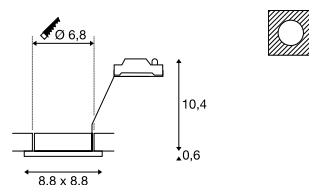

Note

Material thickness, mounting surface: 20 mm max.

Note

Material thickness, mounting surface: 20 mm max.

Recommended lamp

LED GU5.3 5.5W 36°
2700K 450lm EEL=A+
7kWh/1000h
Item no. 1001574



Recommended lamp

LED GU5.3 5.5W 36°
2700K 450lm EEL=A+
7kWh/1000h
Item no. 1001574



Lamp details

max. 50W QR-C51

Lamp details

max. 50W QR-C51

Variant	Item no.
GX5.3 QR-C51	
□ white	1001157

Variant	Item no.
GX5.3 QR-C51	
□ white	1001161



1001157 460



1001166 461



1001172 461

DOLIX OUT
EL, round, QPAR51

E-A++ Range A++-E



Product details

220-240V ~50/60Hz
Material: Aluminium / Glass

Dimensioned drawing

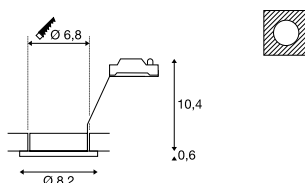

Note

Material thickness, mounting surface: 20 mm max.

Recommended lamp

LED GU10 5.5W 38°
2700K 400lm EEL=A+
6kWh/1000h

Item no. 1001030



LED GU10 7.2W 36°
3000K 520lm EEL=A+
8kWh/1000h

Item no. 1001562



Lamp details

max. 50W QPAR51

Variant	Item no.
GU10 QPAR51 white	1001165
GU10 QPAR51 chrome	1001166
GU10 QPAR51 grey / transparent	1001167
GU10 QPAR51 chrome	1001168

DOLIX OUT
EL, square, QPAR51

E-A++ Range A++-E



Product details

220-240V ~50/60Hz
Material: Aluminium / Glass

Dimensioned drawing

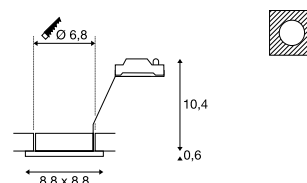

Note

Material thickness, mounting surface: 20 mm max.

Recommended lamp

LED GU10 5.5W 38°
2700K 400lm EEL=A+
6kWh/1000h

Item no. 1001030



LED GU10 7.2W 36°
3000K 520lm EEL=A+
8kWh/1000h

Item no. 1001562



Lamp details

max. 50W QPAR51

Variant	Item no.
GU10 QPAR51 white	1001169
GU10 QPAR51 chrome	1001170
GU10 QPAR51 grey / transparent	1001171
GU10 QPAR51 chrome	1001172

VARU
EL, QPAR51

A-A++ Range A++-E



- High IP protection class
- Resistant housing

Product details

230V~50Hz
Material: Aluminium / Glass

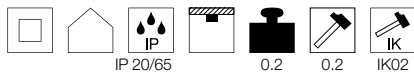

Dimensioned drawing

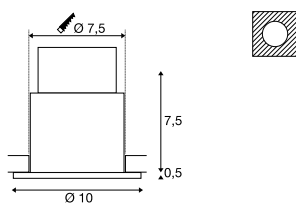

Note

Material thickness, mounting surface: 15 mm

Recommended lamp

GU10 5.5W 36°
2800K 420lm EEL=A+
6kWh/1000h
Item no. 1001217



LED GU10 7.2W 36°
2700K 520lm EEL=A+
8kWh/1000h
Item no. 1001560



Lamp details

max. 5W LED GU10 51mm
Ø: 5 cm max. L: 4.6 cm max.

Variant	Item no.
GU10 LED GU10 51mm ■ black	1001930
GU10 LED GU10 51mm □ white	1001931

VARU
EL

A-A++ Range A++-E



- High IP protection class
- Resistant housing
- Reduced glare due to set-back LED

Product details

350mA | 5W
Material: Aluminium / Glass

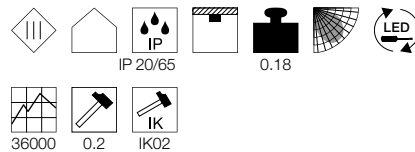

Dimensioned drawing

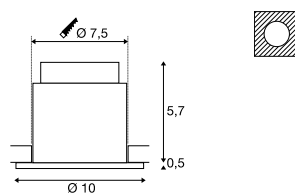

Note

Material thickness, mounting surface: 15 mm

Recommended accessories

□ LED driver 350mA | 9W
Item no. 464109



Variant	Item no.
400lm 2700K CRI>80 ■ black	1001932
400lm 2700K CRI>80 □ white	1001933

1001931 462



1000931 462



KAMUELA ECO
EL, round, TRIAC

A-A++ Range
A++-E



- Fire-resistant for at least 90 minutes in accordance with BS 476-21
- LED service life 35,000h
- IP 65 luminaire with efficient LED technology

Product details

220-240V ~50Hz
Total consumption: 6.5W
Material: Aluminium / Plastic
Dimmable: Triac C, Triac L

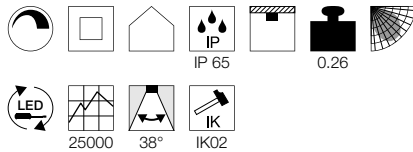

Dimensioned drawing

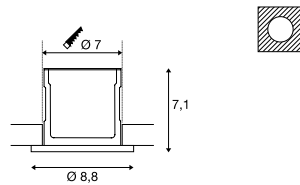

Note

Material thickness, mounting surface: 40 mm max.

Variant	Item no.
400lm 3000K CRI>80	
■ black	1001015
400lm 3000K CRI>80	
□ white	1001016
400lm 4000K CRI>80	
■ black	1001017
400lm 4000K CRI>80	
□ white	1001018

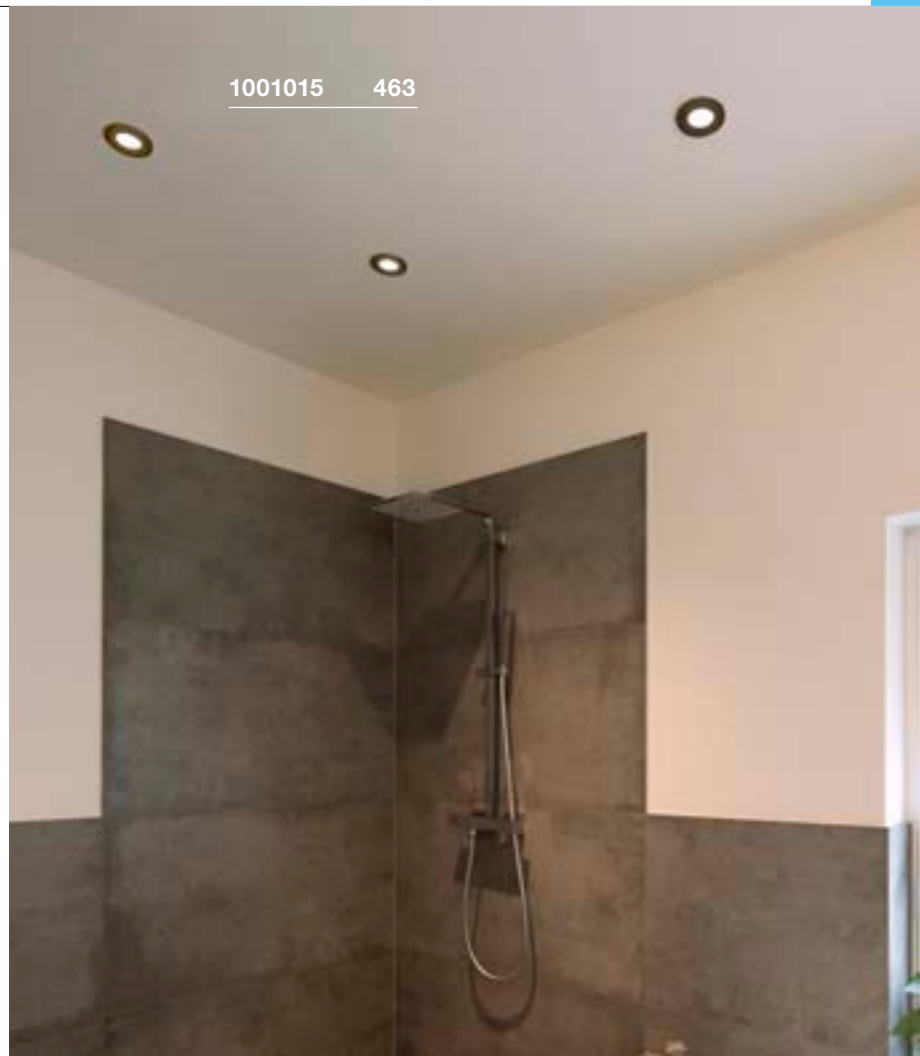

AKALO D83
EL, TRIACA-A++ Range
A++-ELED
INSIDE

NEW



1001264 464



- The light colour can be set using the switch on the rear

Product details

220-240V ~50/60Hz | 120mA

Total consumption: 9W

Material: Aluminium / Polycarbonate (PC)

Dimmable: Triac C

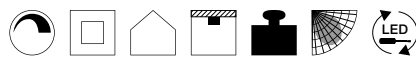

0.18



30000 90° 0.2 IK02

Dimensioned drawing

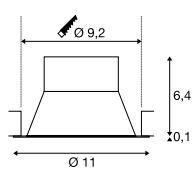

Note

Material thickness, mounting surface: 20 mm

Variant	Item no.
800/880/850lm 3000/4200/5700K CRI>80	
□ white	1001264



114440 465



114440 465

PATTA-F
EL, round, TRIAC

A-A++ Range A++-E



- High IP protection class (full-surface protection glass)

Product details

220-240V ~50/60Hz | 500mA
Total consumption: 11W
Material: Aluminium / Glass
Dimmable: Triac C, Triac L

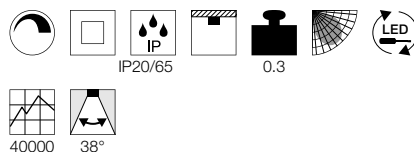

Dimensioned drawing

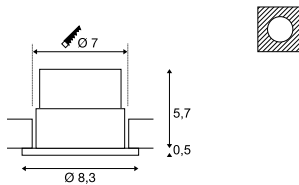

Note

Material thickness, mounting surface: 20 mm

Variant	Item no.
745lm 3000K CRI>80	
■ black	114440
860lm 3000K CRI>80	
□ white	114441

PATTA-F
EL, square, TRIAC

A-A++ Range A++-E



- High IP protection class (full-surface protection glass)

Product details

220-240V ~50/60Hz | 500mA
Total consumption: 11W
Material: Aluminium / Glass
Dimmable: Triac C, Triac L

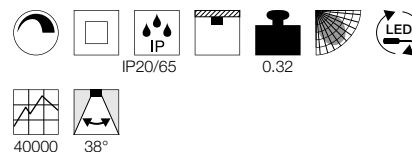

Dimensioned drawing

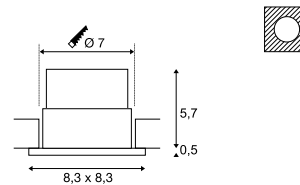

Note

Material thickness, mounting surface: 20 mm

Variant	Item no.
745lm 3000K CRI>80	
■ black	114450
860lm 3000K CRI>80	
□ white	114451

PATTA-I
EL, round, TRIAC



- Premium LED with CRI>90
- Dim to Warm (1800-3000K)
- High IP protection class

Product details

220-240V ~50/60Hz | 350mA
Total consumption: 7.3W
Material: Aluminium / Glass
Dimmable: Triac C, Triac L

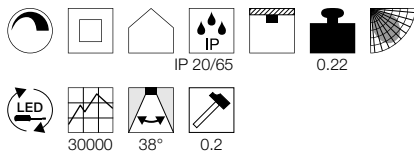

Dimensioned drawing

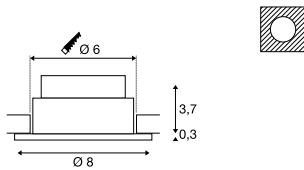

Note

Products supplied with clip springs. Leaf springs included with the product and can be exchanged
Material thickness, mounting surface: 20 mm

An application video about Dim to Warm can be found at <http://bit.ly/dim-to-warm>



PATTA-I
EL, square, TRIAC

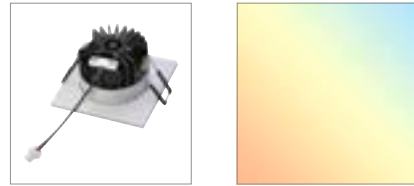

- Premium LED with CRI>90
- Dim to Warm (1800-3000K)
- High IP protection class

Product details

220-240V ~50/60Hz | 350mA
Total consumption: 7.3W
Material: Aluminium / Glass
Dimmable: Triac C, Triac L

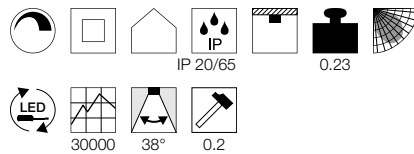

Dimensioned drawing

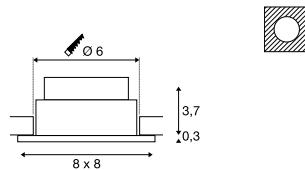

Note

Products supplied with clip springs. Leaf springs included with the product and can be exchanged
Material thickness, mounting surface: 20 mm

An application video about Dim to Warm can be found at <http://bit.ly/dim-to-warm>



Variant	Item no.
440lm 1800-3000K CRI>95	
■ black	1002098
440lm 1800-3000K CRI>95	
□ matt white	1002099
440lm 1800-3000K CRI>95	
■ matt aluminium	1002100

Variant	Item no.
440lm 1800-3000K CRI95	
■ black	1002101
440lm 1800-3000K CRI95	
□ matt white	1002102
440lm 1800-3000K CRI95	
■ matt aluminium	1002103

1002099 466

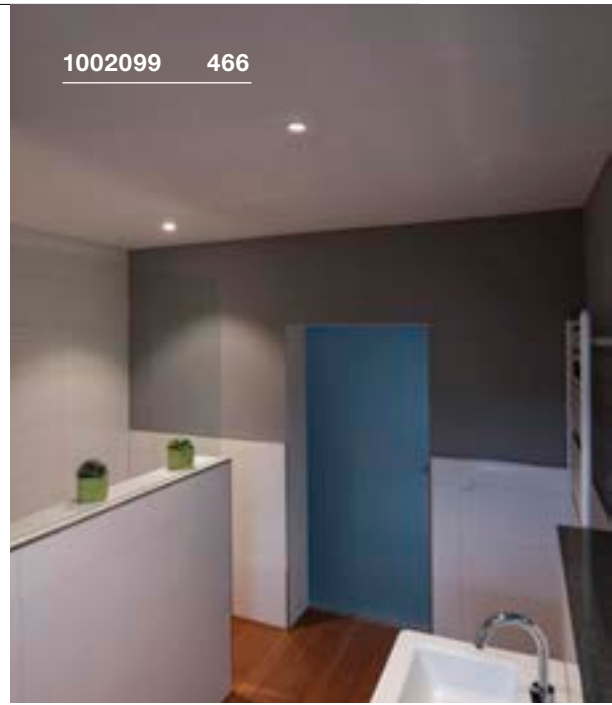

1002101 466

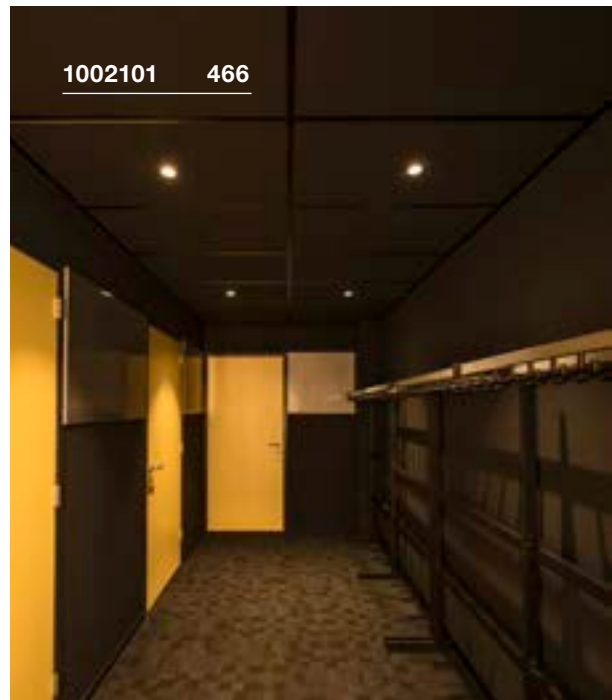

1002101 466

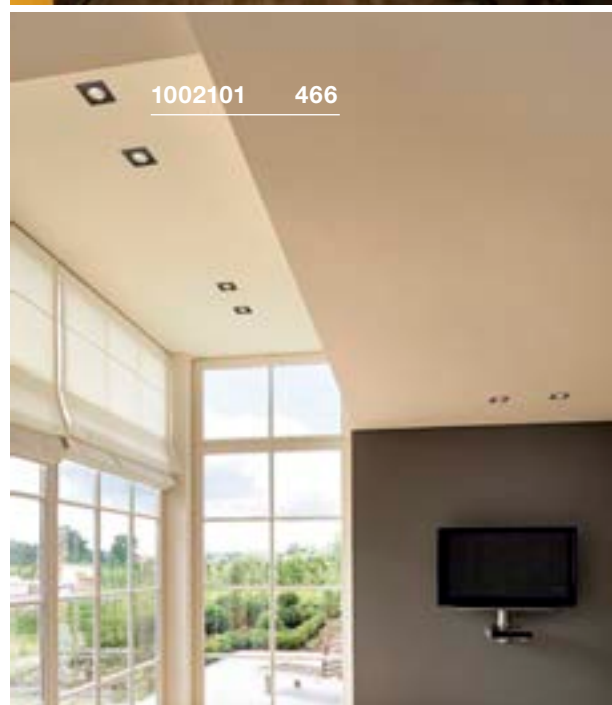



114430 467

PATTA-I
EL, round, TRIAC

A-A++ Range A++-E

LED INSIDE

Home icon with plus sign



- High IP protection class (full-surface protection glass)

Product details

220-240V ~50/60Hz | 500mA
Total consumption: 11W
Material: Aluminium / Glass
Dimmable: Triac C, Triac L

Icons: Beam spread, Square, IP, IP20/65, Mounting, 0.25, LED, 40000, 38°, 0.2, IK02

Dimensioned drawing

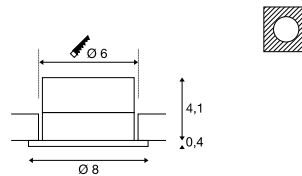

Note

Material thickness, mounting surface: 25 mm

PATTA-I
EL, square, TRIAC

A-A++ Range A++-E

LED INSIDE

Home icon with plus sign



- High IP protection class (full-surface protection glass)

Product details

220-240V ~50/60Hz | 500mA
Total consumption: 11W
Material: Aluminium / Glass
Dimmable: Triac C, Triac L

Icons: Beam spread, Square, IP, IP20/65, Mounting, 0.25, LED, 40000, 38°, 0.2, IK02

Dimensioned drawing

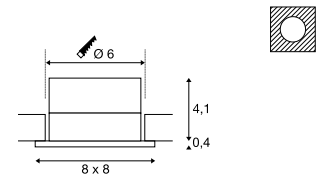

Note

Material thickness, mounting surface: 25 mm



114431 467

Variant	Item no.
910lm 3000K CRI>80	
■ matt black	114420
910lm 3000K CRI>80	
□ matt white	114421
910lm 3000K CRI>80	
■ matt aluminium	114426

Variant	Item no.
910lm 3000K CRI>80	
■ matt black	114430
910lm 3000K CRI>80	
□ matt white	114431
910lm 3000K CRI>80	
■ matt aluminium	114436

117311 469



117331 469

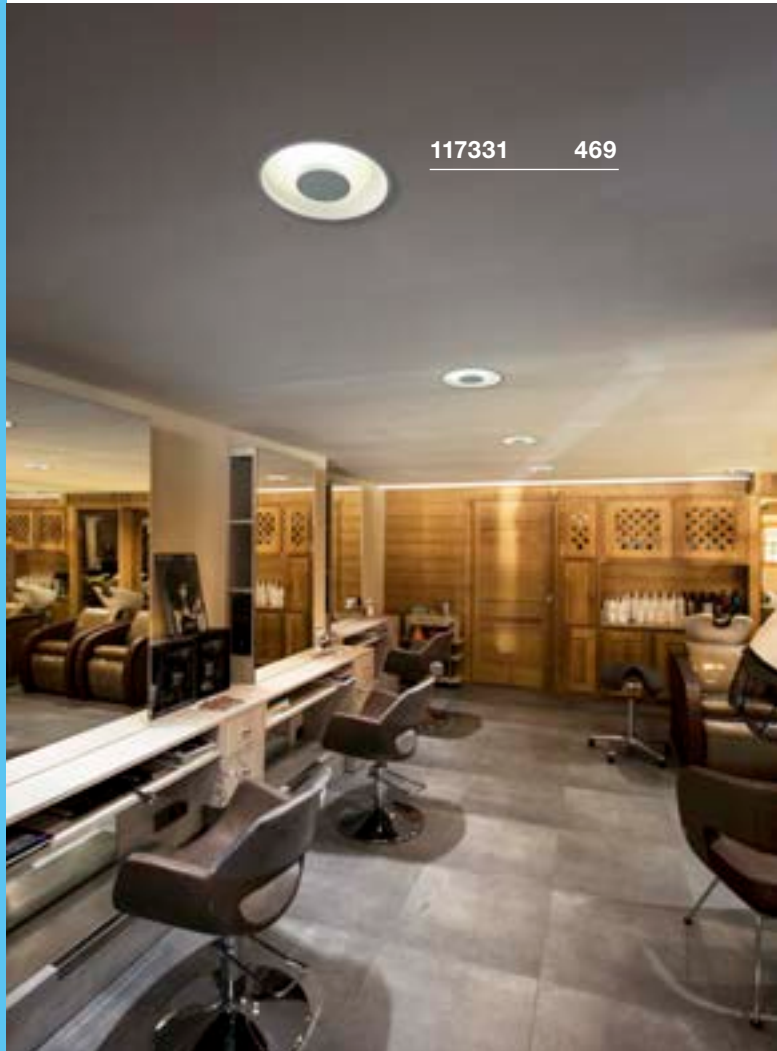

117341 469

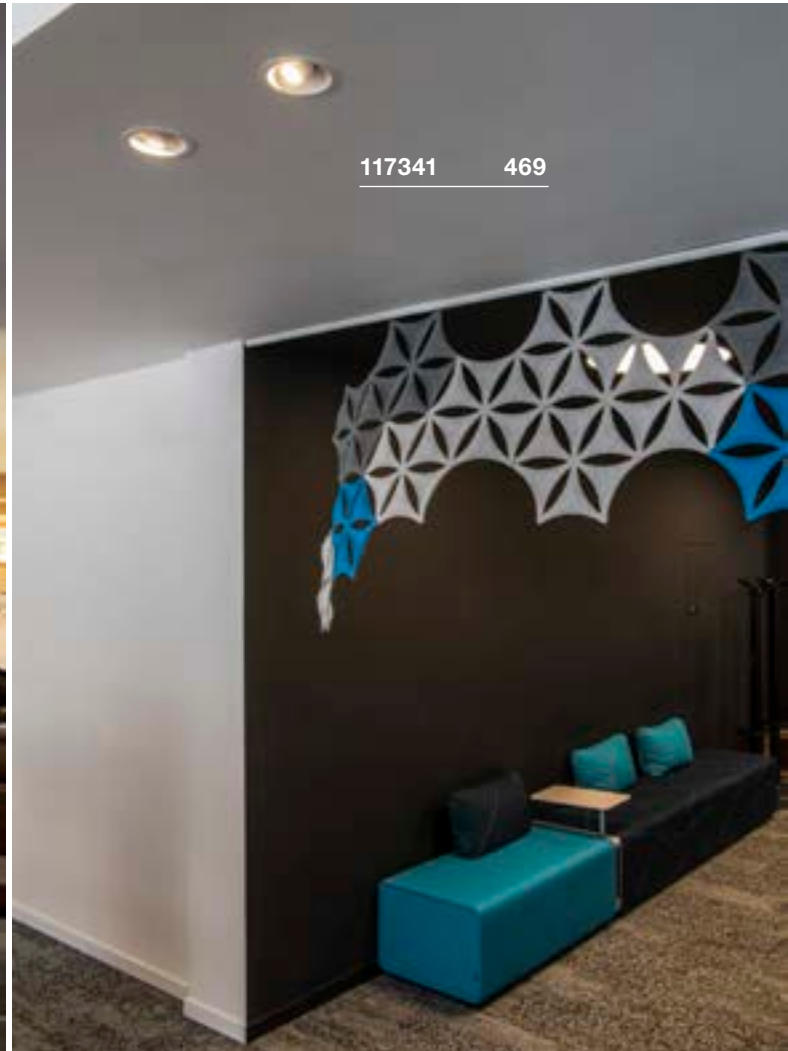

OCCULDAS 23
EL, indirect, TRIAC



A-A++ Range A++-E



- Glare-free, indirect light
- Extremely flat flame and shallow installation depth

Product details

200-240V ~50/60Hz | 700mA
Total consumption: 26W
Material: Aluminium / Steel
Dimmable: Triac C, Triac L

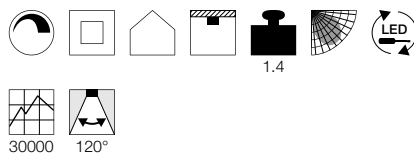

30000 120°

Dimensioned drawing

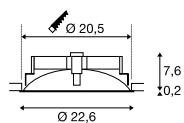

Note

Material thickness, mounting surface:
10-30 mm max.

Variant	Item no.
1500lm 3000K CRI>80 □ white	117311

OCCULDAS 14
EL, indirect, TRIAC



A-A++ Range A++-E



- Glare-free, indirect light
- Extremely flat flame and shallow installation depth

Product details

220-240V ~50/60Hz | 350mA
Total consumption: 15W
Material: Aluminium / Steel
Dimmable: Triac C, Triac L

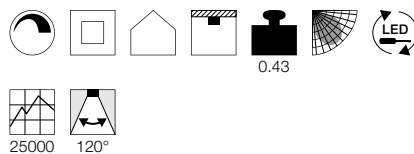

25000 120°

Dimensioned drawing

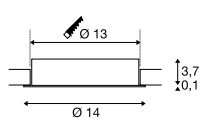

Note

Material thickness, mounting surface:
1-20 mm max.

Variant	Item no.
810lm 3000K CRI>80 □ white	117331

OCCULDAS 14 MOVE
EL, TRIAC



A-A++ Range A++-E



- Adjustable spot
- Extremely flat flame and shallow installation depth

Product details

220-240V ~50/60Hz | 350mA
Total consumption: 7.8W
Material: Aluminium / Steel
Dimmable: Triac C, Triac L

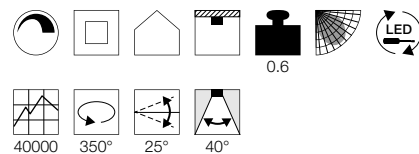

40000 350° 25° 40°

Dimensioned drawing

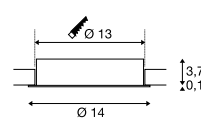

Note

Material thickness, mounting surface:
1-20 mm max.

Variant	Item no.
700lm 3000K CRI>80 □ white	117341

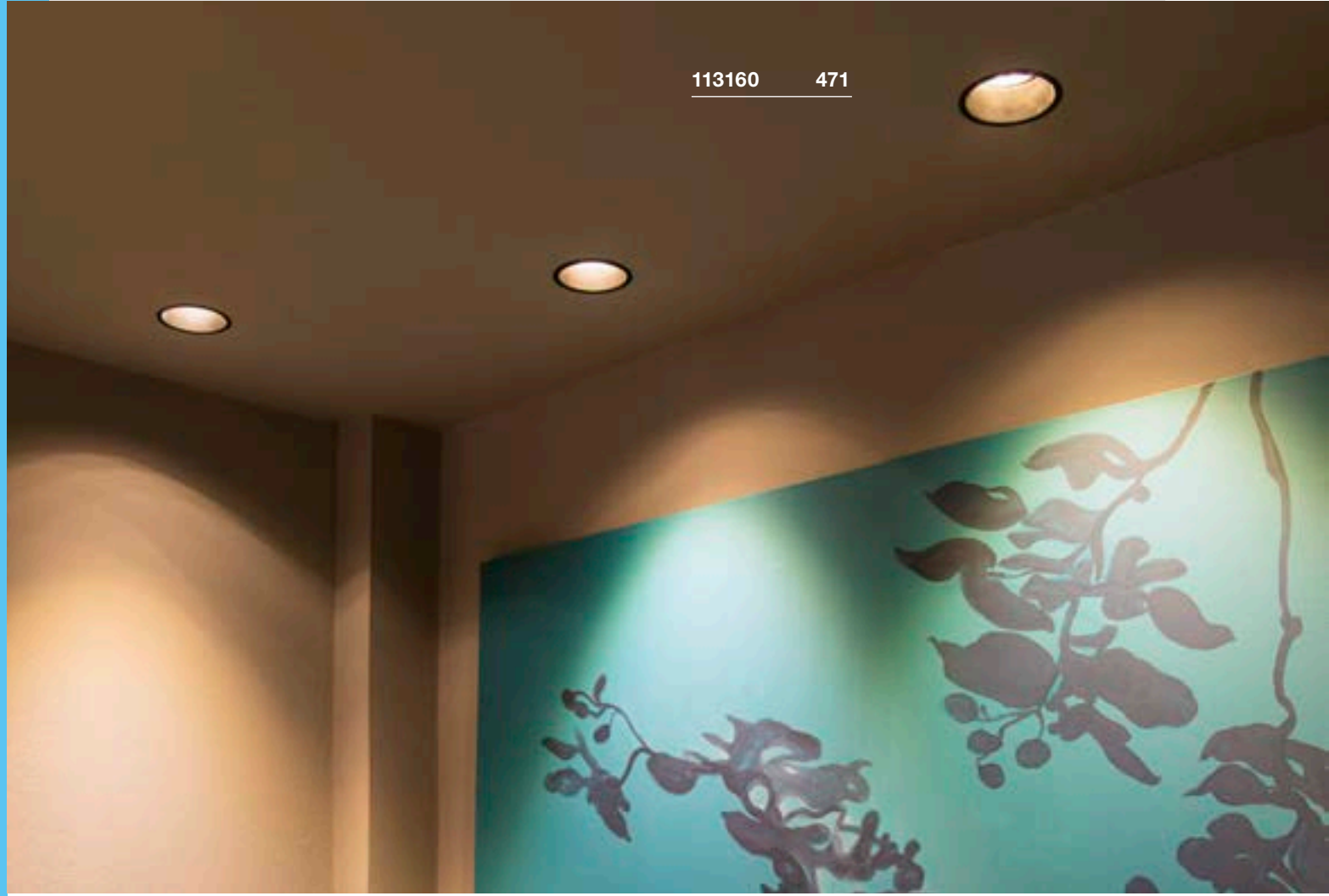

113160 471



113160 471



113151 471

HORN-O
EL, QPAR51

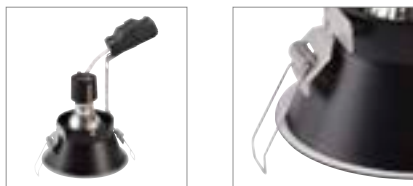

- Narrow installation collar
- Protection glass for IP21 applications

Product details

230V ~50Hz
Material: Steel

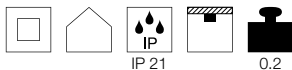

Dimensioned drawing

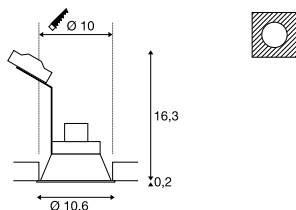

Note

Material thickness, mounting surface: 25mm max.

Recommended lamp

GU10 5.5W 36°
2800K 420lm EEL=A+
6kWh/1000h
Item no. 1001217



LED GU10 5.5W 38°
2700K 400lm EEL=A+
6kWh/1000h
Item no. 1001030



Lamp details

max. 50W QPAR51

Variant	Item no.
GU10 QPAR51	
■ matt black	113160
GU10 QPAR51	
□ matt white	113161

HORN-T
EL, QPAR51



- Narrow installation collar

Product details

220-240V ~50/60Hz
Material: Steel

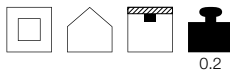

Dimensioned drawing

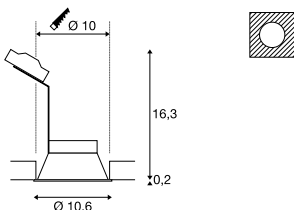

Note

Material thickness, mounting surface: 25mm max.

Recommended lamp

LED GU10 7.2W 36°
4000K 540lm EEL=A+
8kWh/1000h
Item no. 1001565



LED GU10 7W 25/40/55°
3000K 300lm EEL=A
7kWh/1000h
Item no. 560603



Lamp details

max. 50W QPAR51

Variant	Item no.
GU10 QPAR51	
■ matt black	113140
GU10 QPAR51	
□ matt white	113141

HORN-A
EL, QPAR51



- Asymmetrical light emission
- Protection glass for IP21 applications

Product details

230V ~50Hz
Material: Steel

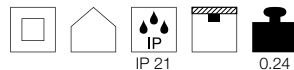

Dimensioned drawing

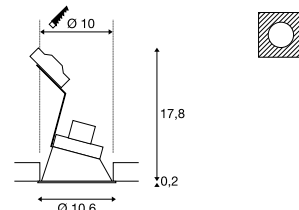

Note

Material thickness, mounting surface: 25 mm

Recommended lamp

LED GU10 7.2W 36°
4000K 540lm EEL=A+
8kWh/1000h
Item no. 1001565



LED GU10 7W 25/40/55°
3000K 300lm EEL=A
7kWh/1000h
Item no. 560603



Lamp details

max. 50W QPAR51

Variant	Item no.
GU10 QPAR51	
■ matt black	113150
GU10 QPAR51	
□ matt white	113151

HORN-T
EL, QPAR11

E-A++ Range A++-E



113170 472



- Narrow installation collar

Product details

230V ~50Hz
Material: Steel

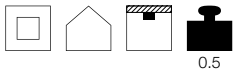

Dimensioned drawing

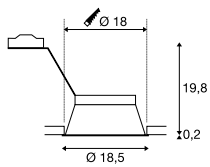

Note

Material thickness, mounting surface: 30 mm max.

Recommended lamp

GU10 7.3W 13°
2700K 660lm EEL=A+
8kWh/1000h
Item no. 1000939



LED GU10 7.9W 40°
4000K 760lm EEL=A+
8kWh/1000h
Item no. 560724



Lamp details

max. 75W QPAR111

Variant	Item no.
GU10 QPAR111	
■ matt black	113170
GU10 QPAR111	
□ matt white	113171

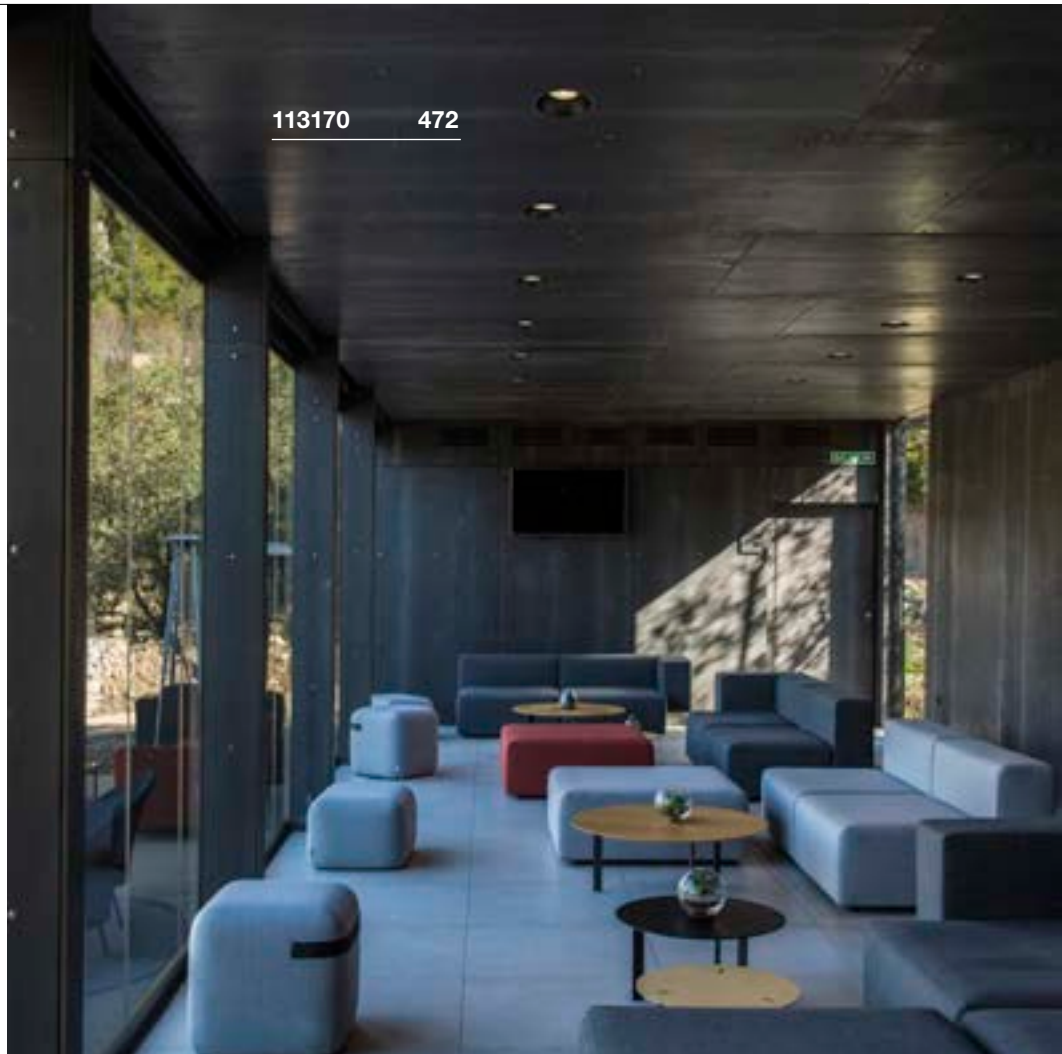

113171 472

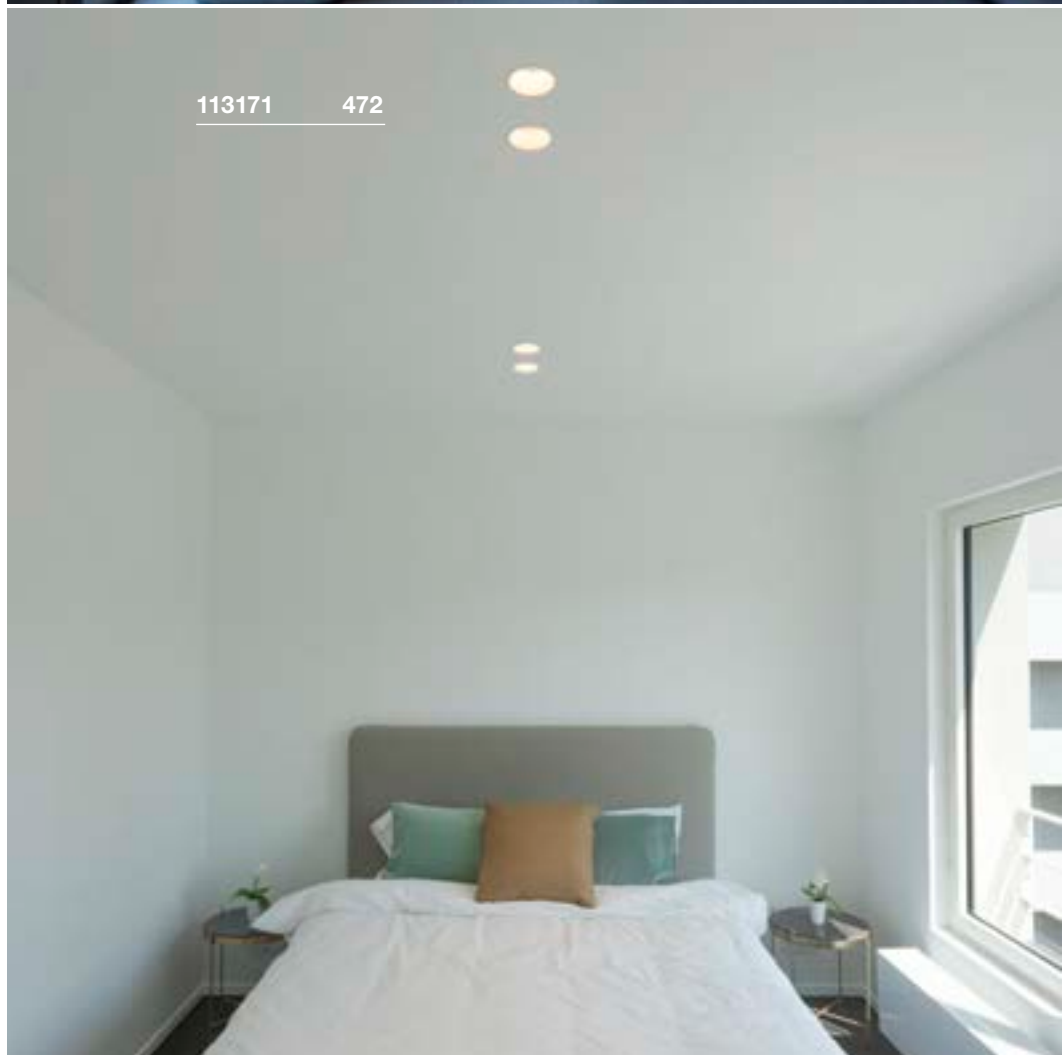



HORN
EL, QPAR51

E-A++ Range A++-E



- Narrow installation collar

Product details

230V ~50Hz
Material: Steel

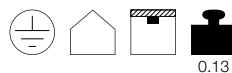

Dimensioned drawing

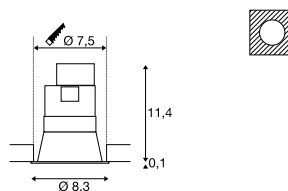

Note

Material thickness, mounting surface: 45 mm max

HORN
EL, QPAR51

E-A++ Range A++-E

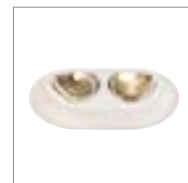

- Narrow installation collar

Product details

230V ~50Hz
Material: Aluminium / Steel

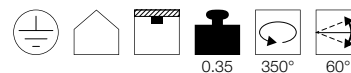

Dimensioned drawing

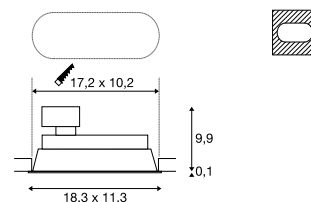

Note

Material thickness, mounting surface: 45 mm max

Recommended lamp

GU10 5.5W 36°
2800K 420lm EEL=A+
6kWh/1000h
Item no. 1001217



LED GU10 5.5W 38°
2700K 400lm EEL=A+
6kWh/1000h
Item no. 1001030



Lamp details

max. 50W QPAR51

Variant	Item no.
GU10 QPAR51	
■ matt black	112910
GU10 QPAR51	
□ matt white	112911

Recommended lamp

LED GU10 5.5W 38°
2700K 400lm EEL=A+
6kWh/1000h
Item no. 1001030



LED GU10 7.2W 36°
2700K 470lm EEL=A+
8kWh/1000h
Item no. 560542



Lamp details

2x max. 50W QPAR51

Variant	Item no.
GU10 QPAR51	
■ matt black	113110
GU10 QPAR51	
□ matt white	113111

HORN MINI EL



• Premium LED with CRI>90

Product details

350mA | 1.2W
Material: Aluminium / Polycarbonate (PC)

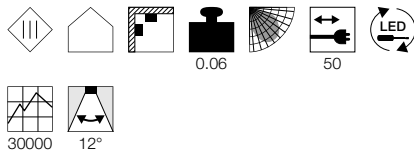

Dimensioned drawing

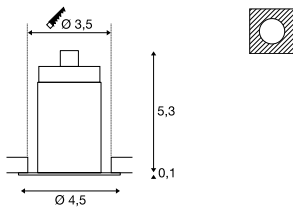

Note

Driver excl.
AMP plug included
Different light colour with gold reflect or

Recommended accessories

- LED driver 350mA | 3W
Item no. 464107
- Multiway connector with 3 outputs
Item no. 111850

Variant	Item no.
70lm 3000K CRI>90 <input type="checkbox"/> white	1000914
70lm 3000K CRI>90 <input checked="" type="checkbox"/> black	1000915
70lm 3000K CRI>90 <input checked="" type="checkbox"/> white / black	1000916
70lm 3000K CRI>90 <input checked="" type="checkbox"/> black / gold	1000917

HORN MEDI EL

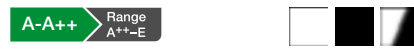

Product details

350mA | 5W
Material: Aluminium / Polycarbonate (PC)

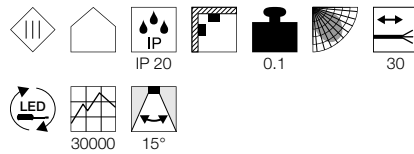

Dimensioned drawing

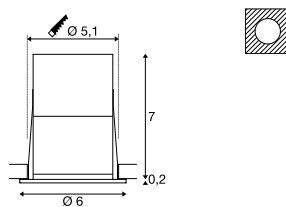

Note

Different light colour with gold reflect or
Open cable end

Recommended accessories

- LED driver 350mA | 10W
Item no. 464140

Variant	Item no.
350lm 3000K CRI>80 <input type="checkbox"/> white	1001924
230lm 3000K CRI>80 <input checked="" type="checkbox"/> black	1001925
230lm 3000K CRI>80 <input checked="" type="checkbox"/> white / black	1001926
275lm 3000K CRI>80 <input checked="" type="checkbox"/> black	1001927

HORN MAGNA EL

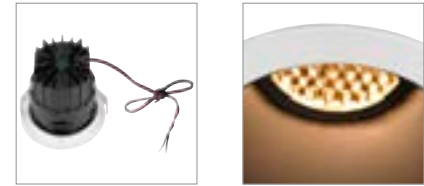

Product details

500mA | 7.7W
Material: Aluminium / Polycarbonate (PC)

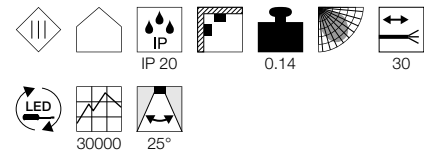

Dimensioned drawing

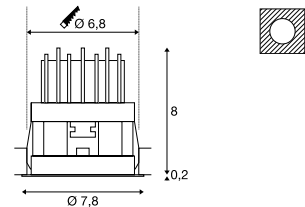

Note

Driver excl.
Different light colour with gold reflect or
Open cable end

Recommended accessories

- Honeycomb module
Item no. 1002596
- LED driver 500mA | 9W
Item no. 464091

Variant	Item no.
470lm 3000K CRI>80 <input type="checkbox"/> white	1002591
415lm 3000K CRI>80 <input checked="" type="checkbox"/> black	1002592
415lm 3000K CRI>80 <input checked="" type="checkbox"/> white / black	1002593
400lm 3000K CRI>80 <input checked="" type="checkbox"/> black / gold	1002594

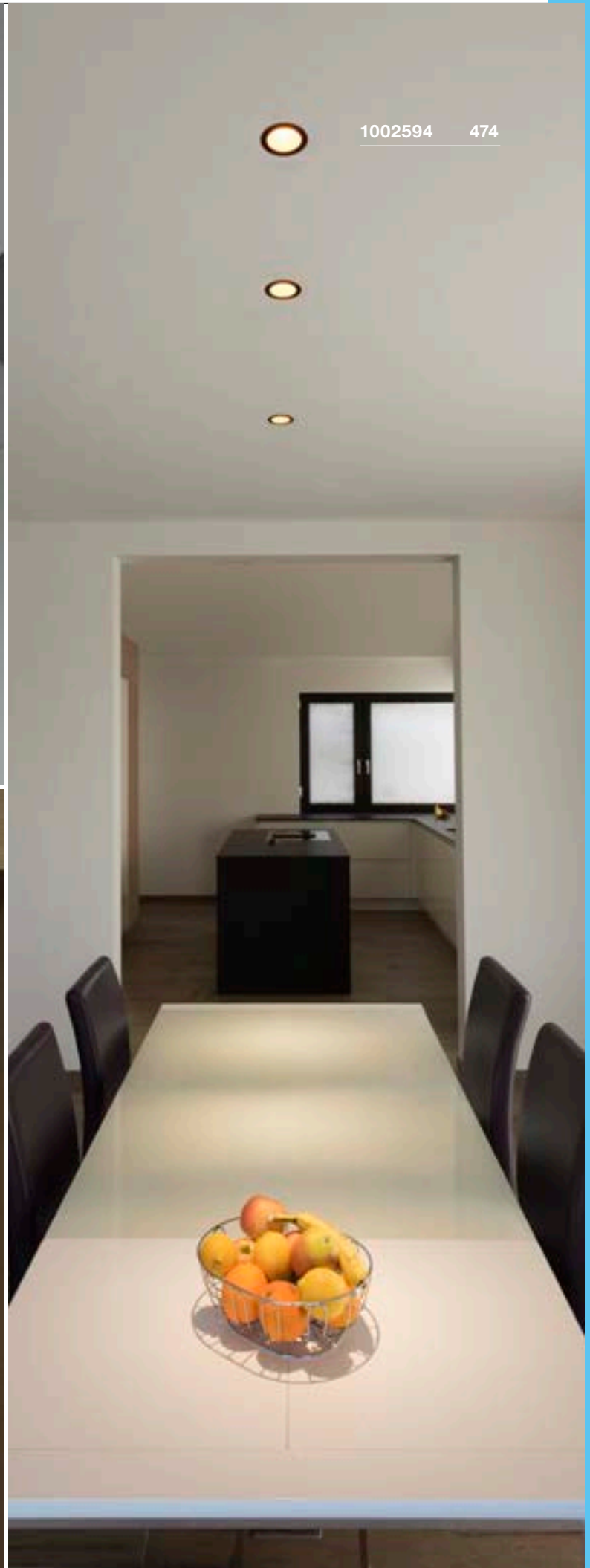

RENISTO EL, square, housing, TRIAC

A-A++ Range A+~E

- Homogeneous design
- Many different combinations of products in the family
- Inner cover can be chosen individually via accessories

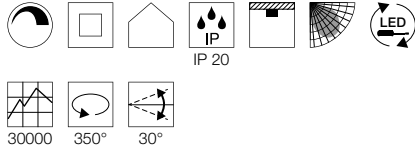

Note

Material thickness, mounting surface: 30 mm
A suitable cover is required, see recommended accessory



RENISTO S EL, square, housing, TRIAC



Product details

220-240V ~50/60Hz | 500mA
Total consumption: 9.6W
Material: Aluminium
Dimmable: Triac C, Triac L

Dimensioned drawing

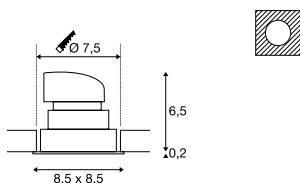

Recommended accessories

White cover

Item no. 1001831

Silver cover

Item no. 1001832



Variant	Item no.
500lm 3000K CRI>80 0.206 kg 36°	
<input type="checkbox"/> white	1001828

RENISTO M EL, square, housing, TRIAC



Product details

220-240V ~50/60Hz | 350mA
Total consumption: 16W
Material: Aluminium
Dimmable: Triac C

Dimensioned drawing

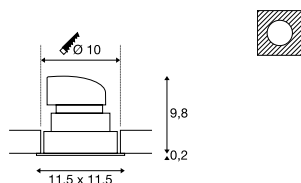

Recommended accessories

White cover

Item no. 1001833

Silver cover

Item no. 1001834



Variant	Item no.
900lm 3000K CRI>80 0.408 kg 36°	
<input type="checkbox"/> white	1001829

RENISTO L EL, square, housing, TRIAC



Product details

220-240V ~50/60Hz | 700mA
Total consumption: 29W
Material: Aluminium
Dimmable: Triac C, Triac L

Dimensioned drawing

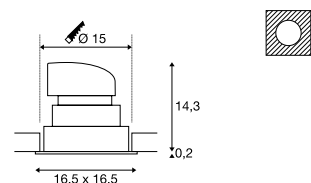

Recommended accessories

White cover

Item no. 1001835

Silver cover

Item no. 1001836



Variant	Item no.
2500lm 3000K CRI>80 0.991 kg 40°	
<input type="checkbox"/> white	1001830



RENISTO
EL, round, housing, TRIAC

A-A++ Range A++-E

- Homogeneous design
- Many different combinations of products in the family
- Inner cover can be chosen individually via accessories

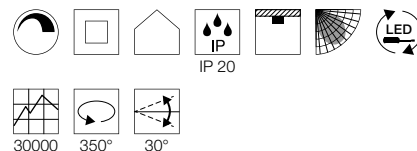

Note

Material thickness, mounting surface: 30 mm
A suitable cover is required, see recommended accessory

RENISTO S
EL, round, housing, TRIAC



Product details

220-240V ~50/60Hz | 500mA
Total consumption: 9.6W
Material: Aluminium
Dimmable: Triac C, Triac L

Dimensioned drawing

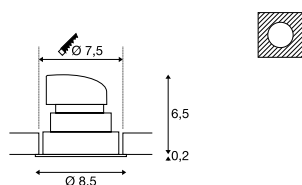

Recommended accessories

- White cover
Item no. 1001849
- Silver cover
Item no. 1001850

Variant	Item no.
500lm 3000K CRI>80 0.206 kg 36°	1001847
<input type="checkbox"/> white	

RENISTO M
EL, round, housing, TRIAC



Product details

220-240V ~50/60Hz | 350mA
Total consumption: 16W
Material: Aluminium
Dimmable: Triac C, Triac L

Dimensioned drawing

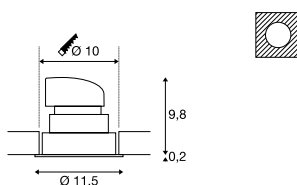

Recommended accessories

- White cover
Item no. 1001851
- Silver cover
Item no. 1001825

Variant	Item no.
900lm 3000K CRI>80 0.408 kg 36°	1001841
<input type="checkbox"/> white	

RENISTO L
EL, round, housing, TRIAC



Product details

220-240V ~50/60Hz | 700mA
Total consumption: 29W
Material: Aluminium
Dimmable: Triac C

Dimensioned drawing

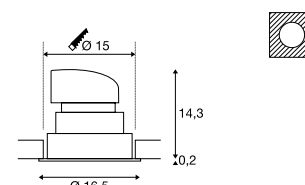

Recommended accessories

- White cover
Item no. 1001826
- Silver cover
Item no. 1001827

Variant	Item no.
2500lm 3000K CRI>80 0.991 kg 40°	1001848
<input type="checkbox"/> white	

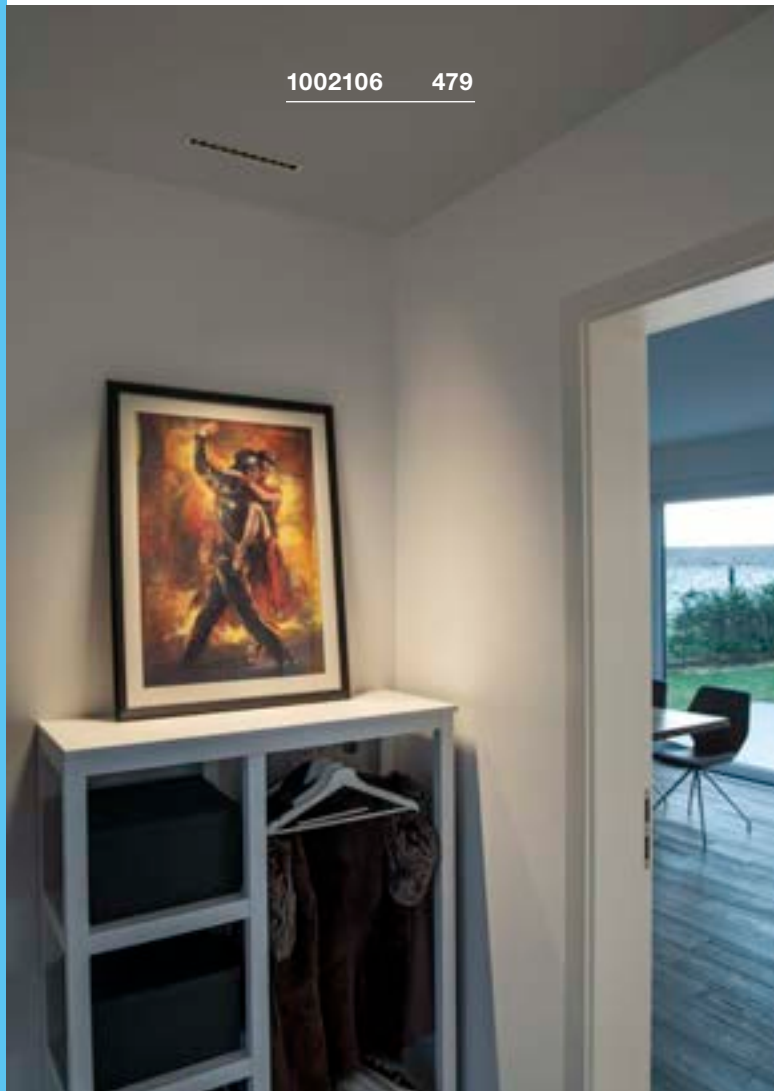
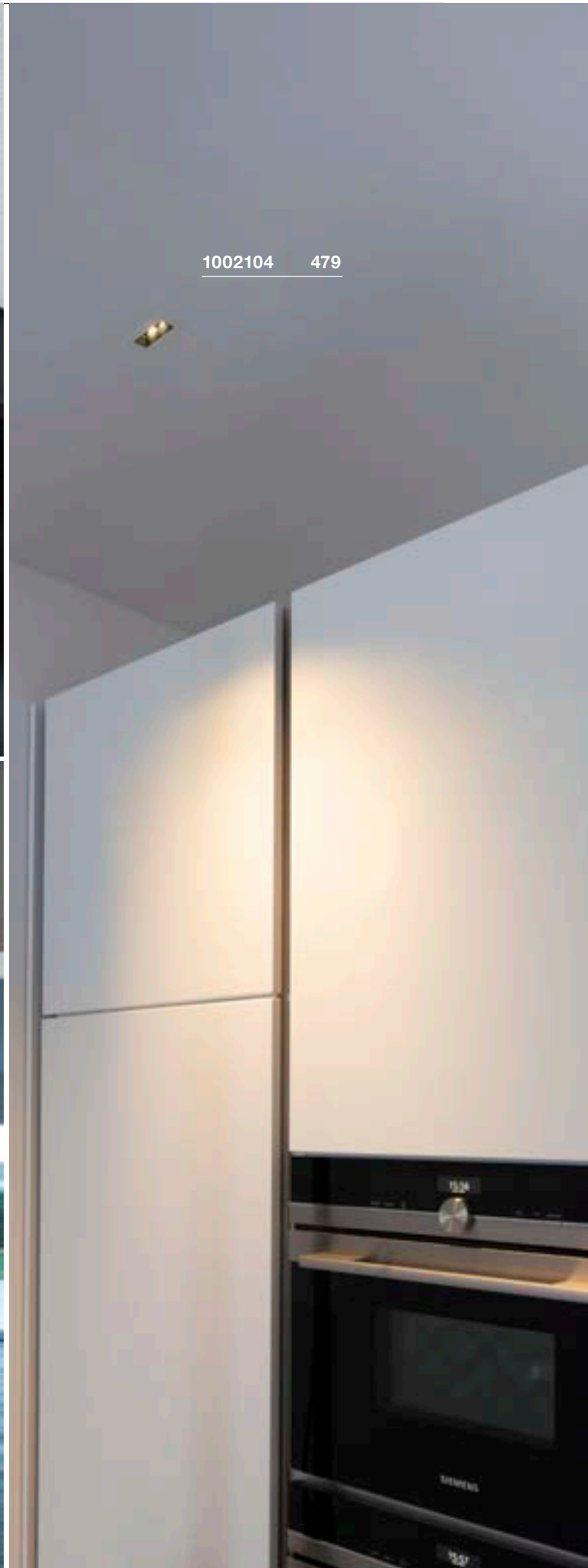

MILANDO 2 EL



Product details

700mA | 4.3W
Material: Steel / Polycarbonate (PC)

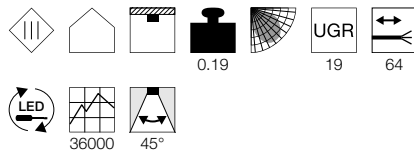

Dimensioned drawing

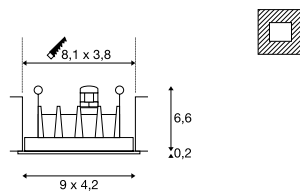

Note

Open cable end
Material thickness, mounting surface: 40 mm

Recommended accessories

LED driver 700mA | 11W incl. strain relief
Item no. 464030

Variant	Item no.
280lm 3000K CRI>80	
■ black	1002107
280lm 3000K CRI>80	
■ black/white	1002104

MILANDO 5 EL



Product details

700mA | 10.7W
Material: Steel / Polycarbonate (PC)

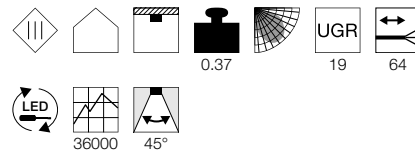

Dimensioned drawing

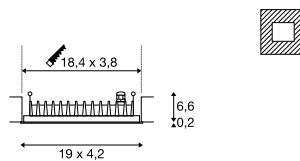

Note

Open cable end
Material thickness, mounting surface: 40 mm

Recommended accessories

LED driver 700mA | 11W incl. strain relief
Item no. 464030

Variant	Item no.
640lm 3000K CRI>80	
■ black	1002108
640lm 3000K CRI>80	
■ black/white	1002105

MILANDO 10 EL



Product details

700mA | 21.4W
Material: Steel / Polycarbonate (PC)

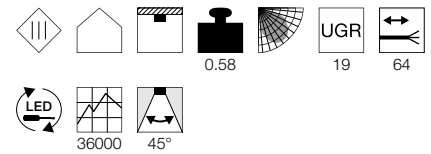

Dimensioned drawing

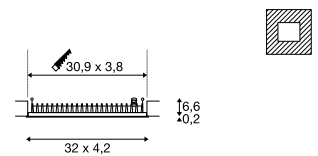

Note





Open cable end
Material thickness, mounting surface: 40 mm

Recommended accessories

TRIAC LED driver 700mA | 40W
Item no. 1001267

Variant	Item no.
1240lm 3000K CRI>80	
■ black	1002109
1240lm 3000K CRI>80	
■ black/white	1002106

NEW TRIA LIGHT SERIES. RECESSED FITTING.

Conventional NEW TRIA	NEW TRIA 68	NEW TRIA 78 XL	NEW TRIA 78	NEW TRIA 78
Example				
Shape				
Lamp	QPAR51	QPAR51	QPAR51	QPAR51
Lumen	-	-	-	-
Colour	-	-	-	-
Dimmable	-	-	-	-
Variant	Clip springs/leaf springs	Clip springs	Leaf springs	Clip springs
IP	-	-	-	-

LED NEW TRIA	NEW TRIA 45	NEW TRIA 68	NEW TRIA 68	NEW TRIA 68
Example				
Shape				
Lamp				
Lumen	143lm	300lm	800lm-890lm	440lm
Colour	3000K	2700K/3000K	2700K/3000K	1800K-3000K
Dimmable	-	-	Triac C, Triac L	Triac C, Triac L
Variant	Clip springs	Clip springs	Clip springs	Clip springs/leaf springs
IP	IP 44	-	-	-



	NEW TRIA 155	NEW TRIA 150	NEW TRIA 300
			
			
	QPAR51	QPAR111	QPAR111
	-	-	-
	-	-	-
	Clip springs	Leaf springs	Clip springs
	-	-	-

	NEW TRIA 77	NEW TRIA 155	NEW TRIA 110	NEW TRIA 150
				
				
	LED INSIDE	LED INSIDE	LED INSIDE	LED INSIDE
	645lm-700lm	1160lm-1250lm	1010lm-1120lm	2210lm-2500lm
	2700K/3000K	2700K/3000K	2700K/3000K	2700K/3000K
	-	-	Triac C, Triac L	1-10V
	Clip springs	Clip springs	Clip springs	Clip springs
	-	-	-	-

NEW TRIA 68
Single, round, CS/LS, QPAR51



Product details

230V ~50Hz
Material: Aluminium

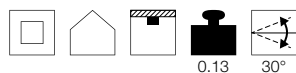

Dimensioned drawing

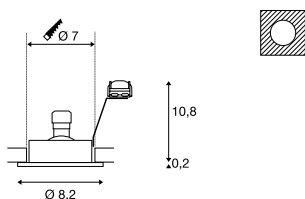

Note

Products supplied with clip springs. Leaf springs included with the product and can be exchanged. Material thickness, mounting surface: 20 mm

Recommended lamp

GU10 5.5W 36°
2800K 420lm EEL=A+
6kWh/1000h
Item no. 1001217



LED GU10 5.1W 48°
2700-6500K 350lm EEL=A+
6kWh/1000h
Item no. 1001918



Lamp details

max. 50W QPAR51

Variant	Item no.
GU10 QPAR51	
■ black	1001980
□ white	1001981
■ matt aluminium	1001982

NEW TRIA 68
Single, square, CS/LS, QPAR51



Product details

230V ~50Hz
Material: Aluminium

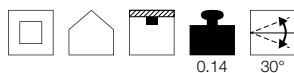

Dimensioned drawing

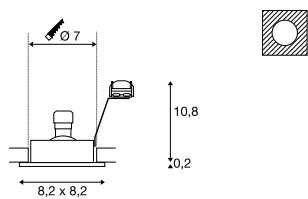

Note

Products supplied with clip springs. Leaf springs included with the product and can be exchanged. Material thickness, mounting surface: 20 mm

Recommended lamp

LED GU10 5.5W 38°
2700K 400lm EEL=A+
6kWh/1000h
Item no. 1001030



LED GU10 7.2W 36°
2700K 470lm EEL=A+
8kWh/1000h
Item no. 560542



Lamp details

max. 50W QPAR51

Variant	Item no.
GU10 QPAR51	
■ black	1001994
□ white	1001995
■ matt aluminium	1001996

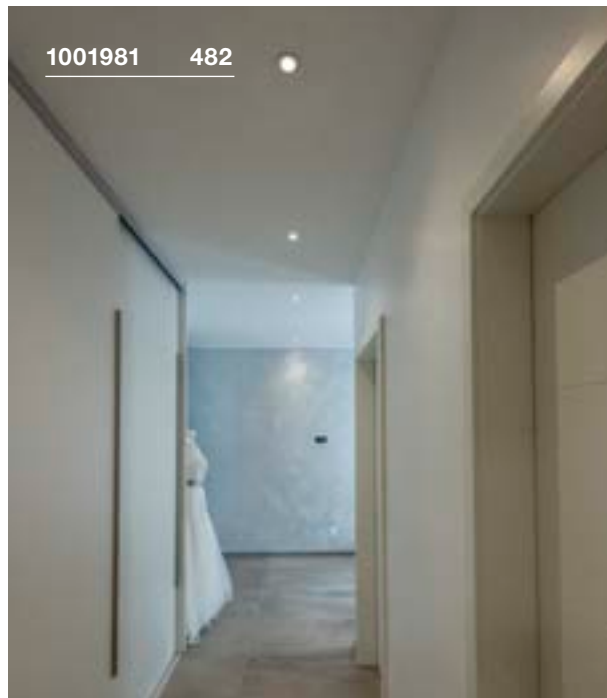
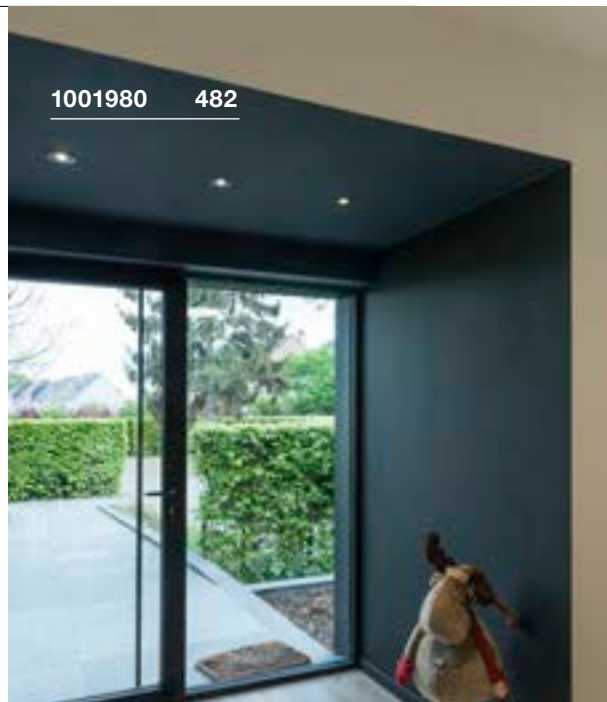



113456 483



113456 483

NEW TRIA 78 XL
Single, round, CS, QPAR51

E-A++ Range A++-E

Color swatches: black, white, aluminium

Home icon with plus sign

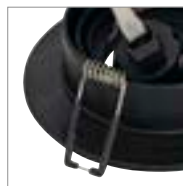

• Wide edge

Product details

230V ~50Hz
Material: Aluminium

Icons: electrical symbol, house, square, circle, rotation arrows

0.19 360° 30°

Dimensioned drawing

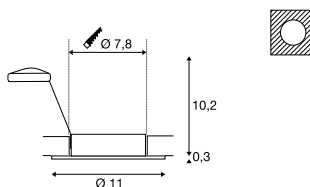

Note

Material thickness, mounting surface: 18 mm

Recommended lamp

GU10 5.5W 36°
2800K 420lm EEL=A+
6kWh/1000h
Item no. 1001217

LED GU10 7.2W 36°
3000K 520lm EEL=A+
8kWh/1000h
Item no. 1001561



Lamp details

max. 50W QPAR51

Variant	Item no.
GU10 QPAR51	
■ matt black	113440
GU10 QPAR51	
□ matt white	113441
GU10 QPAR51	
■ matt aluminium	113446

NEW TRIA 78 XL
Single, square, CS, QPAR51

E-A++ Range A++-E

Color swatches: black, white, aluminium

Home icon with plus sign



• Wide edge

Product details

230V ~50Hz
Material: Aluminium

Icons: electrical symbol, house, square, circle, rotation arrows

0.21 360° 30°

Dimensioned drawing

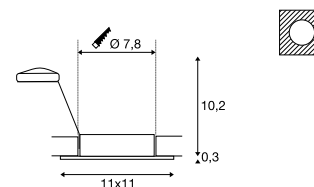

Note

Material thickness, mounting surface: 18 mm

Recommended lamp

LED GU10 5.5W 38°
2700K 400lm EEL=A+
6kWh/1000h
Item no. 1001030

LED GU10 7.2W 36°
2700K 470lm EEL=A+
8kWh/1000h
Item no. 560542



Lamp details

max. 50W QPAR51

Variant	Item no.
GU10 QPAR51	
■ matt black	113450
GU10 QPAR51	
□ matt white	113451
GU10 QPAR51	
■ matt aluminium	113456

NEW TRIA 78
Single, round, LS, QPAR51



NEW TRIA 78
Single, square, LS, QPAR51



Product details

220-240V ~50/60Hz
Material: Aluminium

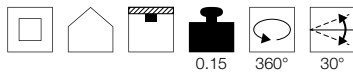

Dimensioned drawing

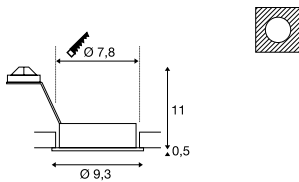

Note

Leaf springs
Material thickness, mounting surface: 20 mm max.

Recommended lamp

GU10 5.5W 36°
2800K 420lm EEL=A+
6kWh/1000h
Item no. 1001217



LED GU10 5.1W 48°
2700-6500K 350lm EEL=A+
6kWh/1000h
Item no. 1001918



Lamp details

max. 50W QPAR51

Variant	Item no.
GU10 QPAR51	
■ matt black	111710
GU10 QPAR51	
□ matt white	111711
GU10 QPAR51	
▒ matt aluminium	111716

Product details

220-240V ~50/60Hz
Material: Aluminium

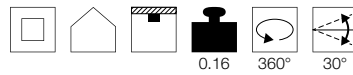

Dimensioned drawing

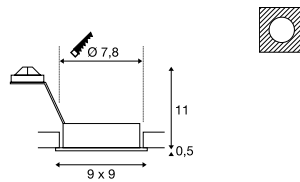

Note

Leaf springs
Material thickness, mounting surface: 20 mm max.

Recommended lamp

LED GU10 5.5W 38°
2700K 400lm EEL=A+
6kWh/1000h
Item no. 1001030



LED GU10 7.2W 36°
2700K 470lm EEL=A+
8kWh/1000h
Item no. 560542



Lamp details

max. 50W QPAR51

Variant	Item no.
GU10 QPAR51	
■ matt black	111720
GU10 QPAR51	
□ matt white	111721
GU10 QPAR51	
▒ matt aluminium	111726

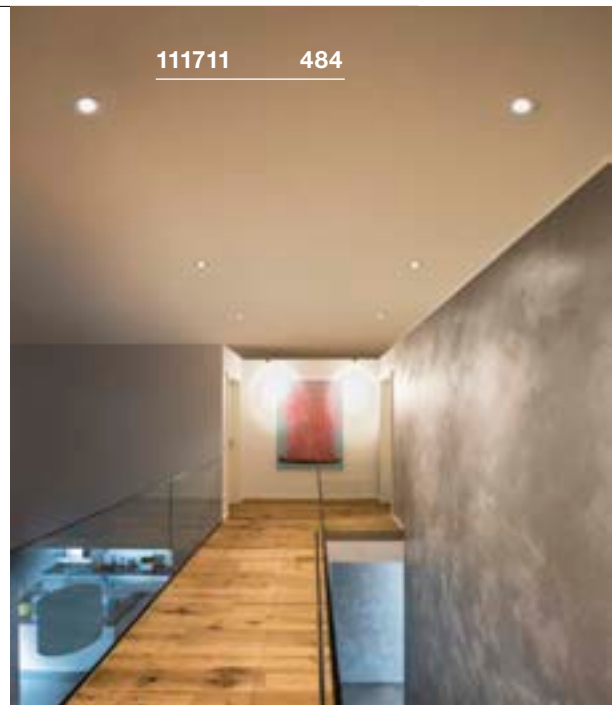

111711 484



111721 482

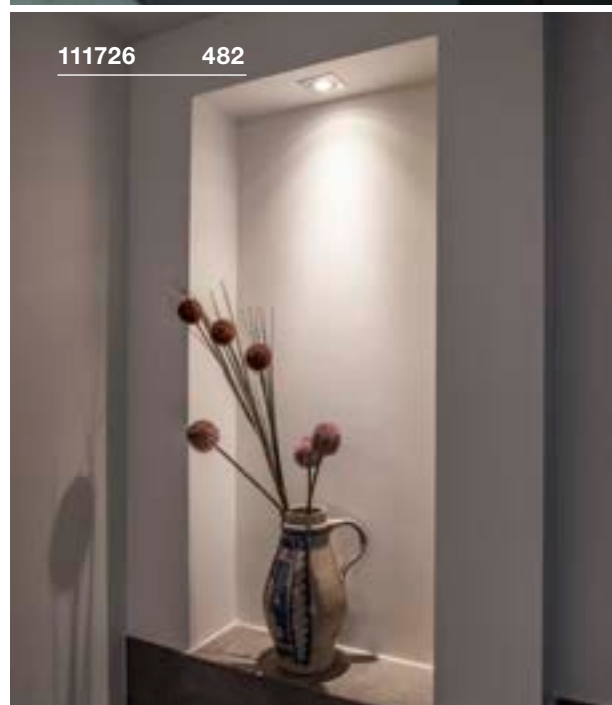

111726 482



113510 485



113510 485

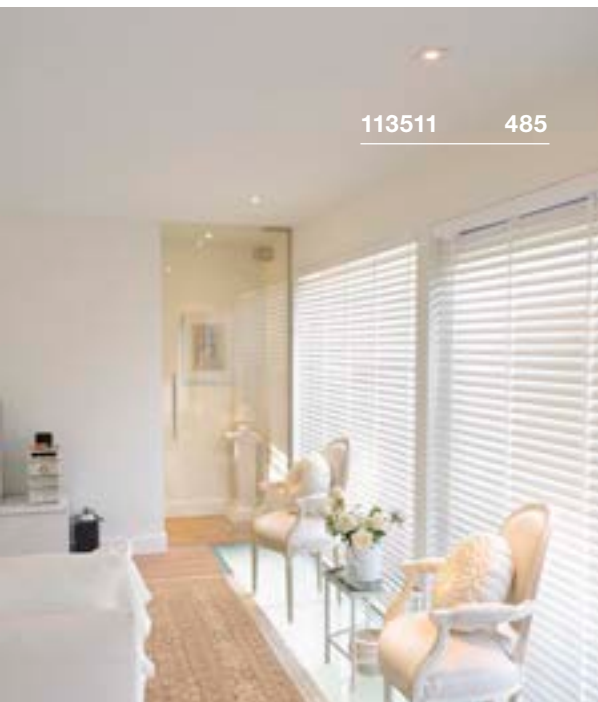

113511 485

NEW TRIA 78
Single, round, CS, QPAR51

E-A++ Range A++-E



NEW TRIA 78
Single, square, CS, QPAR51

E-A++ Range A++-E



Product details

220-240V ~50/60Hz
Material: Aluminium

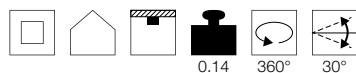

Dimensioned drawing

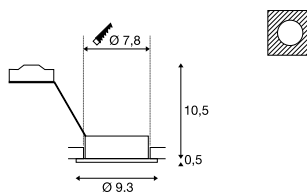

Note

Clip springs
Material thickness, mounting surface: 18 mm max.

Product details

220-240V ~50/60Hz
Material: Aluminium

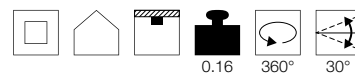

Dimensioned drawing

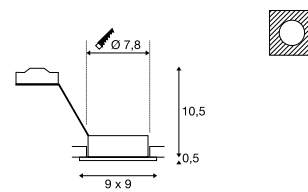

Note

Clip springs
Material thickness, mounting surface: 18 mm max.

Recommended lamp

LED GU10 7.2W 36°
4000K 540lm EEL=A+
8kWh/1000h
Item no. 1001565



LED GU10 7W 25/40/55°
3000K 300lm EEL=A
7kWh/1000h
Item no. 560603



Lamp details

max. 50W QPAR51

Variant	Item no.
GU10 QPAR51	
■ black	113490
□ white	113510
■ matt aluminium	111360

Recommended lamp

GU10 5.5W 36°
2800K 420lm EEL=A+
6kWh/1000h
Item no. 1001217



LED GU10 5.5W 38°
2700K 400lm EEL=A+
6kWh/1000h
Item no. 1001030



Lamp details

max. 50W QPAR51

Variant	Item no.
GU10 QPAR51	
■ black	113491
□ white	113511
■ matt aluminium	111361

NEW TRIA 155
Double, CS, QPAR51



Product details

220-240V ~50/60Hz
Material: Aluminium



Dimensioned drawing

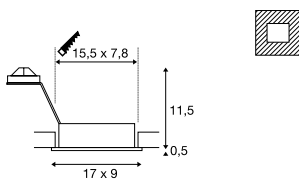

Note

Clip springs
Material thickness, mounting surface: 30 mm max

Recommended lamp

GU10 5.1W 48°
2700-6500K 350lm EEL==A+
6kWh/1000h
Item no. 1001918



LED GU10 5.6W 60°
2200-6700K 350lm EEL==A+
6kWh/1000h
Item no. 1001919



Lamp details

2x max. 50W QPAR51

Variant	Item no.
GU10 QPAR51	
■ black	113492
GU10 QPAR51	
□ white	113512
GU10 QPAR51	
■ matt aluminium	111362

113492 486

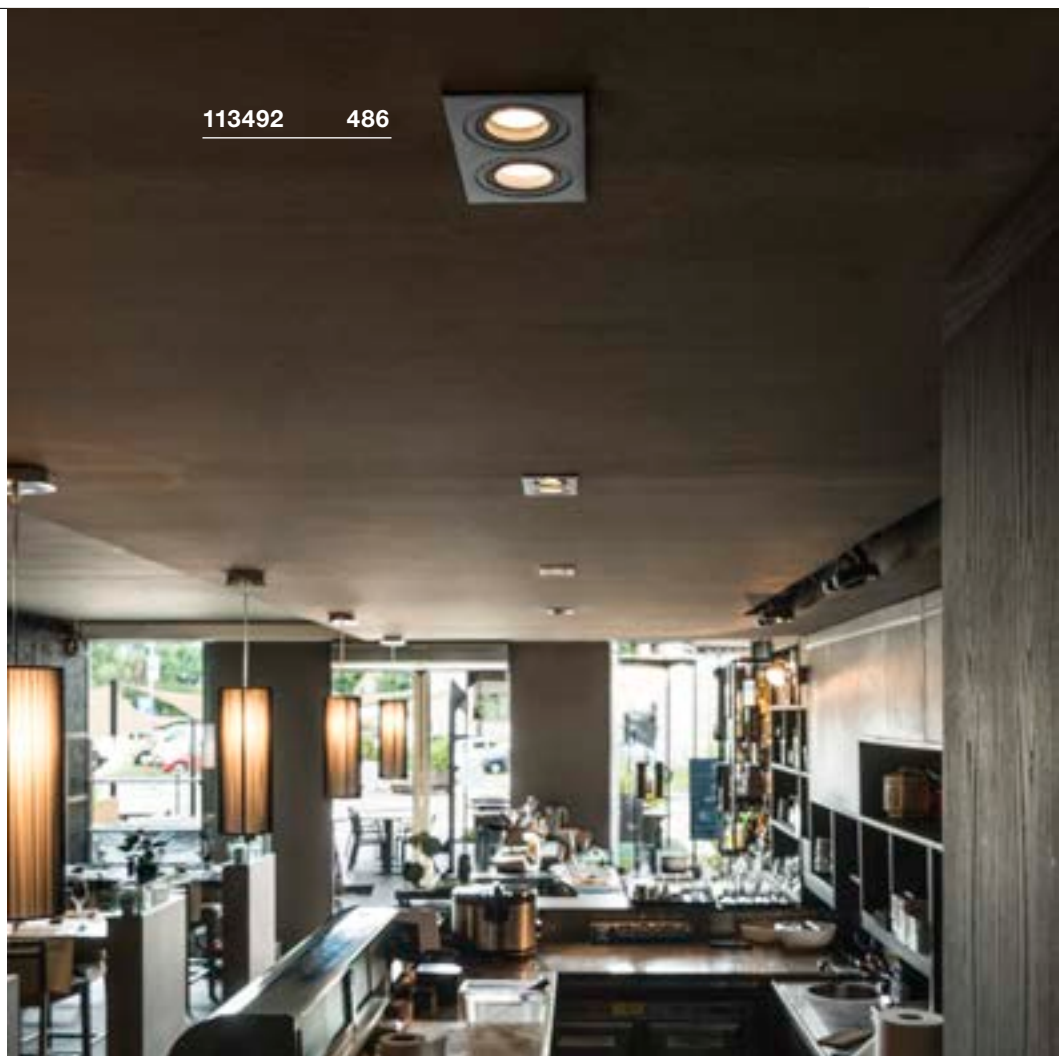

111380 487

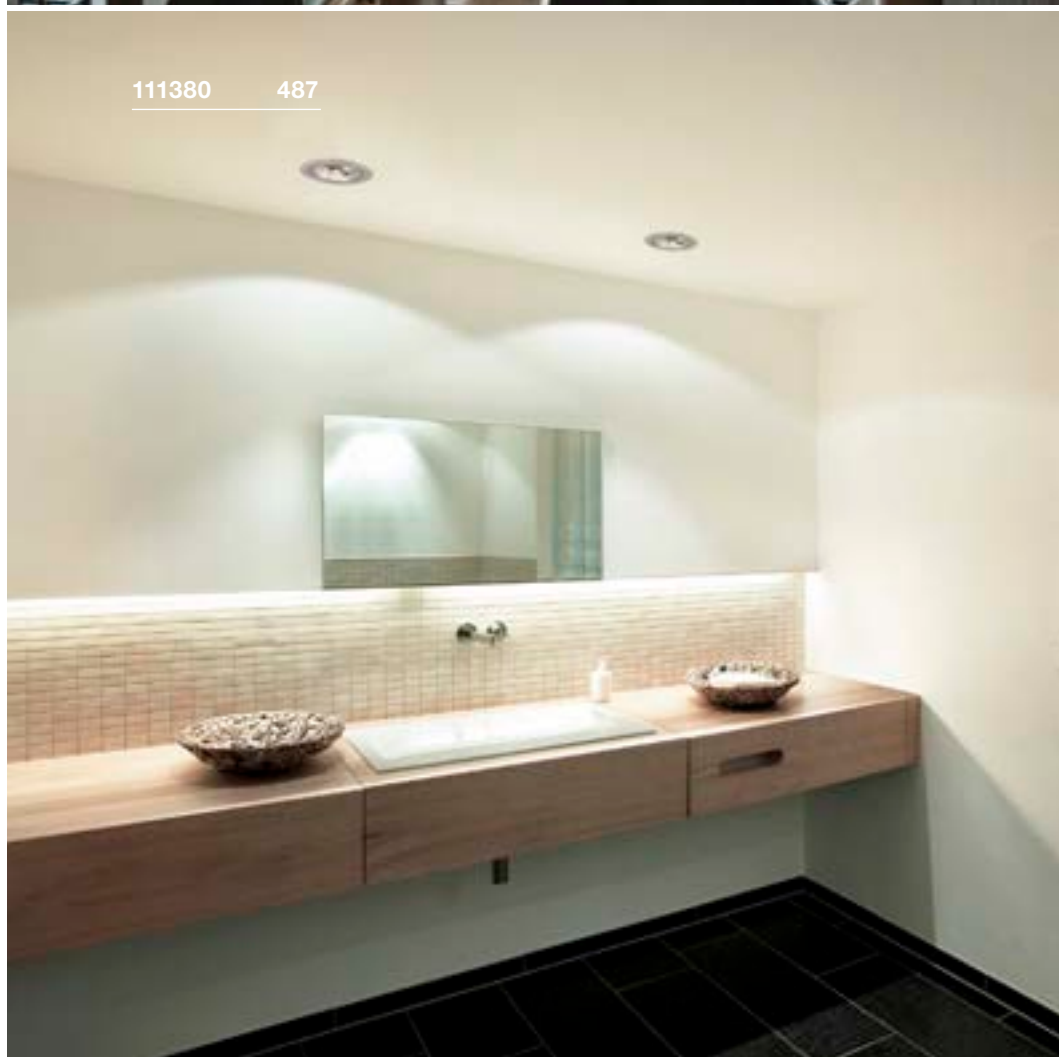

NEW TRIA 150
Single, round, LS, QPAR111



Product details

230V ~50Hz
Material: Aluminium

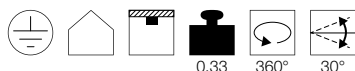

Dimensioned drawing

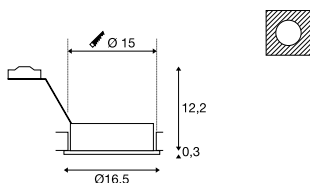

Note

Leaf springs
Material thickness, mounting surface: 30 mm max.

Recommended lamp

LED GU10 10W 38°
3000K 630lm EEL=A+
10kWh/1000h
Item no. 1001029



LED GU10 7W 13°
3000K 660lm EEL=A+
8kWh/1000h
Item no. 1001568



Lamp details

max. 75W QPAR111

Variant	Item no.
GU10 QPAR111	
■ matt black	113550
GU10 QPAR111	
□ matt white	113540
GU10 QPAR111	
■ aluminium	111380

NEW TRIA 150
Single, square, LS, QPAR111



Product details

230V ~50Hz
Material: Aluminium

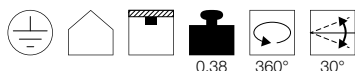

Dimensioned drawing

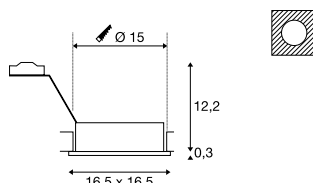

Note

Leaf springs
Material thickness, mounting surface: 30 mm max.

Recommended lamp

LED GU10 13W 30°
2700K 1100lm EEL=A+
13kWh/1000h
Item no. 1001242



LED GU10 7.9W 40°
4000K 760lm EEL=A+
8kWh/1000h
Item no. 560724



Lamp details

max. 75W QPAR111

Variant	Item no.
GU10 QPAR111	
■ matt black	113830
GU10 QPAR111	
□ matt white	113541
GU10 QPAR111	
■ matt aluminium	111381

NEW TRIA 300
Double, CS, QPAR111

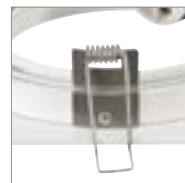
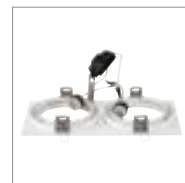

Product details

230V ~50Hz
Material: Aluminium

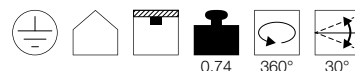

Dimensioned drawing

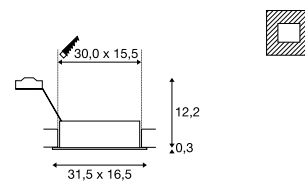

Note

Clip springs
Material thickness, mounting surface: 30 mm max.

Recommended lamp

LED GU10 17.5W 140°
2700K 750lm EEL=A
18kWh/1000h
Item no. 570532



LED GU10 9.5W 40°
2200-6700K 714lm
Item no. 1001923



Lamp details

2x max. 75W QPAR111

Variant	Item no.
GU10 QPAR111	
■ matt black	113840
GU10 QPAR111	
□ matt white	113841
GU10 QPAR111	
■ matt aluminium	111382

NEW TRIA 45
Single, round, CS

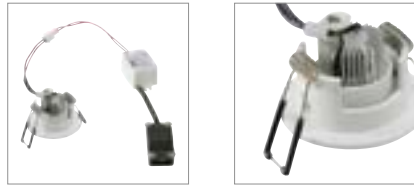

Product details

220-240V ~50/60Hz | 700mA
Total consumption: 4.4W
Material: Aluminium

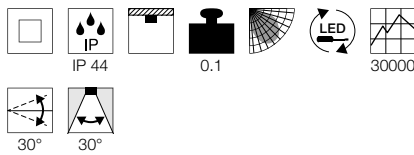

Dimensioned drawing

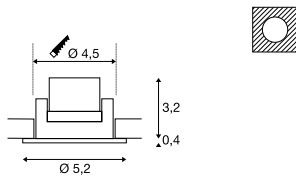

Note

Clip springs
Material thickness, mounting surface: 20 mm max.

NEW TRIA 45
Single, square, CS

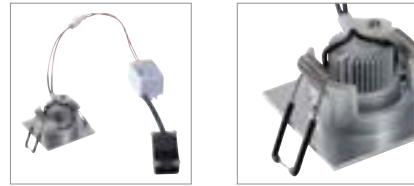

Product details

220-240V ~50/60Hz | 700mA
Total consumption: 4.4W
Material: Aluminium

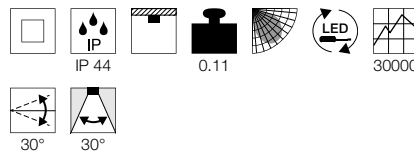

Dimensioned drawing

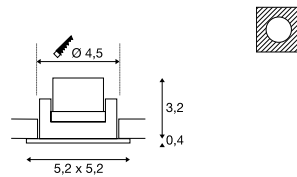

Note

Clip springs
Material thickness, mounting surface: 20 mm max.

Variant	Item no.
143lm 3000K CRI>80 ■ black	113970
143lm 3000K CRI>80 □ matt white	113971
143lm 3000K CRI>80 ■ matt aluminium	113976

Variant	Item no.
143lm 3000K CRI>80 ■ matt black	114400
143lm 3000K CRI>80 □ matt white	114401
143lm 3000K CRI>80 ■ matt aluminium	114406

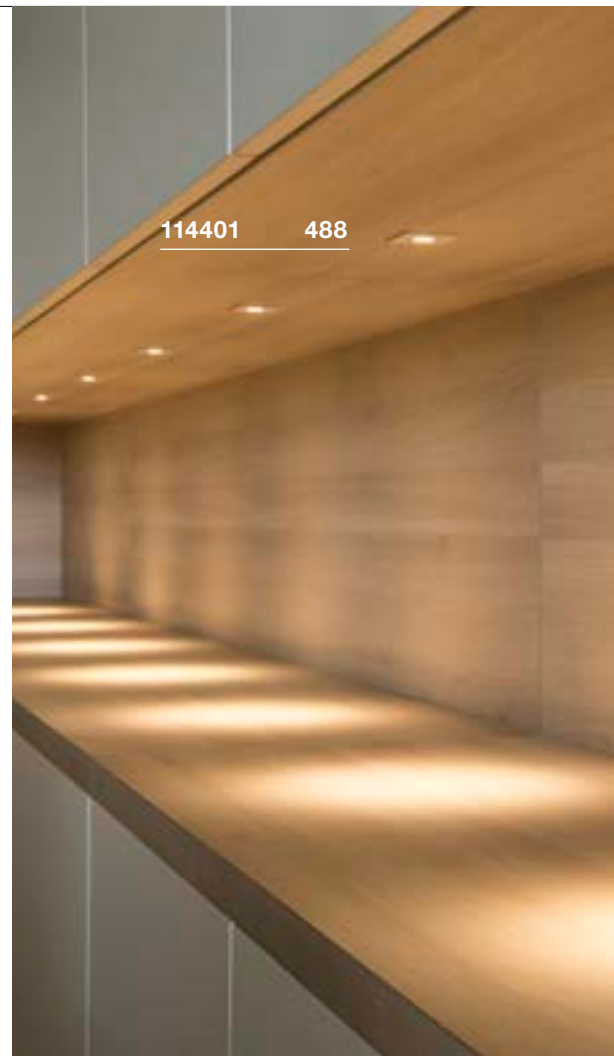



113951 489



1003058 489

NEW TRIA 68
Single, round, CS

A-A++ Range A++-E

LED INSIDE

NEW VARIANT



- Premium LED
- Installation depth <40 mm
- Convenient ceiling cut-out for standard drill bits

Product details

220-240V ~50/60Hz | 350mA
Total consumption: 5.3W
Material: Aluminium

Icons representing: square cut-out, house shape, mounting hole, depth 0.19, beam angle 30°/38°, LED, and 40000 hours lifespan.

Dimensioned drawing

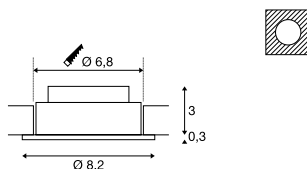

Note

Clip springs
Material thickness, mounting surface: 20 mm

Variant	Item no.
300lm 3000K CRI80	
■ matt black	1003057
300lm 2700K CRI80	
■ matt black	1003058
300lm 2700K CRI80	
□ matt white	1003059
300lm 2700K CRI80	
■ brushed aluminium	1003060
300lm 3000K CRI80	
□ matt white	113951
300lm 3000K CRI80	
■ brushed aluminium	113956

NEW TRIA 68
Single, square, CS

A-A++ Range A++-E

LED INSIDE

NEW VARIANT



- Premium LED
- Installation depth <40 mm
- Convenient ceiling cut-out for standard drill bits

Product details

220-240V ~50/60Hz | 350mA
Total consumption: 5.3W
Material: Aluminium

Icons representing: square cut-out, house shape, mounting hole, depth 0.19, beam angle 38°/38°, LED, and 40000 hours lifespan.

Dimensioned drawing

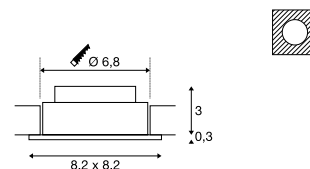

Note

Clip springs
Material thickness, mounting surface: 20 mm

Variant	Item no.
300lm 3000K CRI80	
■ matt black	1003061
300lm 2700K CRI80	
■ matt black	1003062
300lm 2700K CRI80	
□ matt white	1003063
300lm 2700K CRI80	
■ brushed aluminium	1003064
300lm 3000K CRI80	
□ matt white	113961
300lm 3000K CRI80	
■ brushed aluminium	113966

NEW TRIA 68
EL, single, round, CS, TRIAC



Product details

220-240V ~50/60Hz | 500mA
Total consumption: 12W
Material: Aluminium
Dimmable: Triac C, Triac L

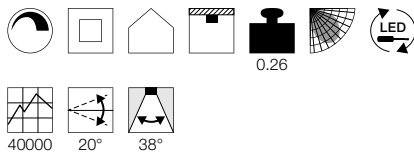

Dimensioned drawing

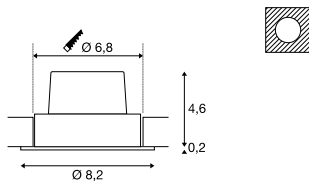

Note

Clip springs
Material thickness, mounting surface: 20 mm

Variant	Item no.
800lm 2700K CRI>80 ■ matt aluminium	1003067
890lm 3000K CRI>80 ■ matt black	114380
890lm 3000K CRI>80 ■ matt white	114381
890lm 3000K CRI>80 ■ brushed aluminium	114386

NEW TRIA 68
Single, square, CS, TRIAC



Product details

220-240V ~50/60Hz | 500mA
Total consumption: 11W
Material: Aluminium
Dimmable: Triac C, Triac L

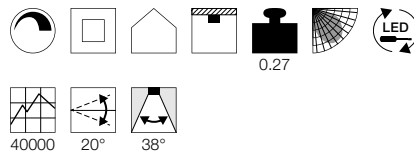

Dimensioned drawing

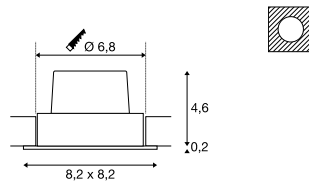

Note

Clip springs
Material thickness, mounting surface: 20 mm

Variant	Item no.
800lm 2700K CRI>80 ■ matt black	1003068
800lm 2700K CRI>80 ■ matt white	1003069
800lm 2700K CRI>80 ■ matt aluminium	1003070
890lm 3000K CRI>80 ■ matt black	114390
890lm 3000K CRI>80 ■ matt white	114391
890lm 3000K CRI>80 ■ brushed aluminium	114396

• Installation depth <40mm



114380 490

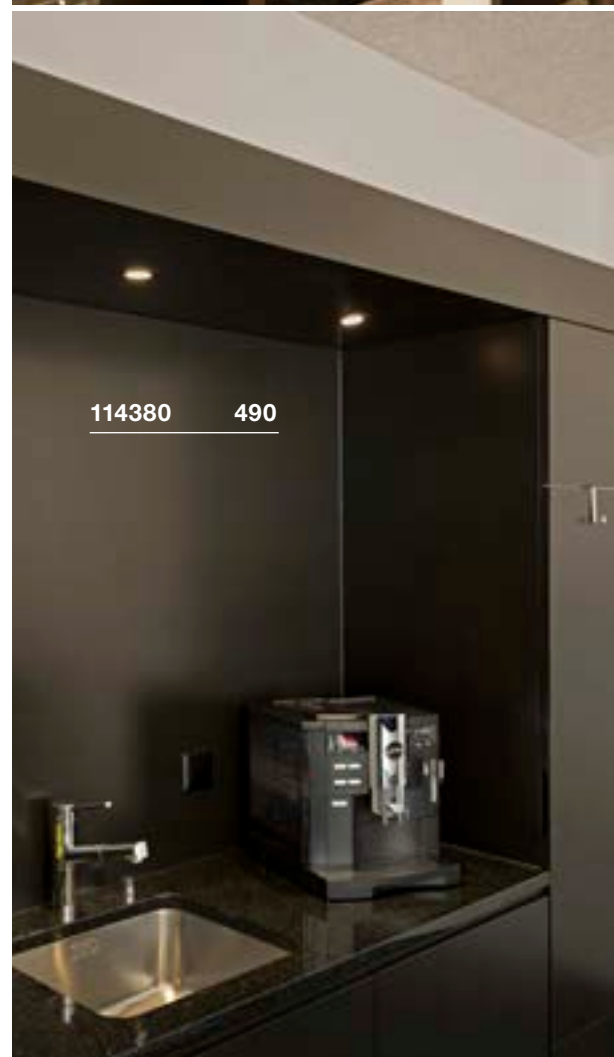

114380 490



1001989 491



1001991 491

NEW TRIA 68
Single, round, CS/LS, TRIAC

A-A++ Range A++-E

LED INSIDE

Dim to Warm



- Premium LED with CRI>90
- Dim to Warm (1800-3000K)
- Installation height <40mm

Product details

220-240V ~50/60Hz | 350mA
Total consumption: 7.3W
Material: Aluminium
Dimmable: Triac C, Triac L

30000 30° 38°

Dimensioned drawing

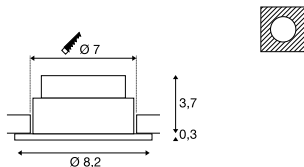

Note

Material thickness, mounting surface: 20 mm

An application video about Dim to Warm can be found at <http://bit.ly/dim-to-warm>



Variant	Item no.
440lm 1800-3000K CRI>95	
■ matt black	1001978
440lm 1800-3000K CRI>95	
□ matt white	1001989
440lm 1800-3000K CRI>95	
▒ matt aluminium	1001990

NEW TRIA 68
Single, square, CS/LS, TRIAC

A-A++ Range A++-E

LED INSIDE

Dim to Warm



- Premium LED with CRI>90
- Dim to Warm (1800-3000K)
- Installation height <40mm

Product details

220-240V ~50/60Hz | 350mA
Total consumption: 7.3W
Material: Aluminium
Dimmable: Triac C, Triac L

30000 30° 38°

Dimensioned drawing

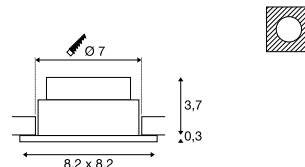

Note

Material thickness, mounting surface: 20 mm

An application video about Dim to Warm can be found at <http://bit.ly/dim-to-warm>



Variant	Item no.
440lm 1800-3000K CRI>95	
■ black	1001991
440lm 1800-3000K CRI>95	
□ matt white	1001992
440lm 1800-3000K CRI>95	
▒ brushed aluminium	1001993

NEW TRIA 77
Single, round, CS



Product details

220-240V ~50/60Hz | 350mA
Total consumption: 8W
Material: Aluminium

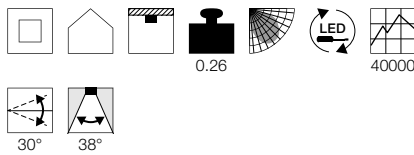

Dimensioned drawing

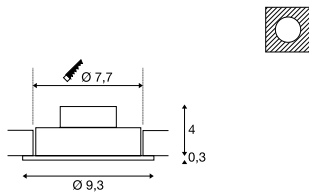

Note

Clip springs
Material thickness, mounting surface: 20 mm max.

NEW TRIA 77
Single, square, CS

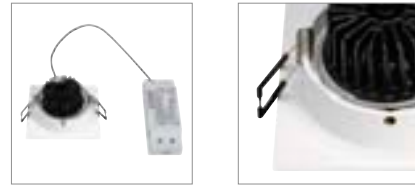

Product details

220-240V ~50/60Hz | 350mA
Total consumption: 8W
Material: Aluminium

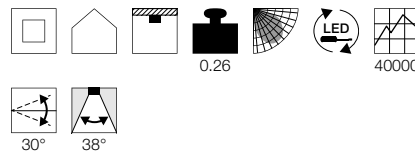

Dimensioned drawing

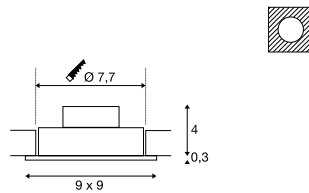

Note

Clip springs
Material thickness, mounting surface: 20 mm max.

Variant	Item no.
645lm 2700K CRI>80 ■ matt black	113870
645lm 2700K CRI>80 □ white	113871
645lm 2700K CRI>80 ■ matt aluminium	113876
700lm 3000K CRI>80 ■ matt black	113900
700lm 3000K CRI>80 □ white	113901
700lm 3000K CRI>80 ■ matt aluminium	113906

Variant	Item no.
645lm 2700K CRI>80 ■ matt black	113880
645lm 2700K CRI>80 □ white	113881
645lm 2700K CRI>80 ■ matt aluminium	113886
700lm 3000K CRI>80 ■ matt black	113910
700lm 3000K CRI>80 □ white	113911
700lm 3000K CRI>80 ■ matt aluminium	113916



113916

492



113890 493

NEW TRIA 155
Double, CS

A-A++ Range A++-E

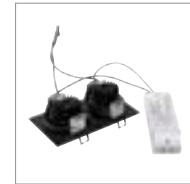

Product details

220-240V ~50/60Hz | 350mA
Total consumption: 14W
Material: Aluminium

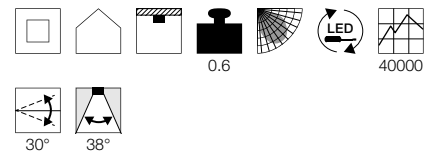

Dimensioned drawing

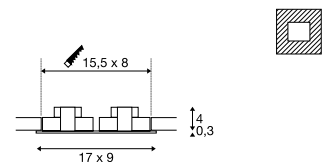

Note

Clip springs
Material thickness, mounting surface: 30 mm max.



113926 493

Variant	Item no.
1160lm 2700K CRI>80 ■ matt black	113890
1160lm 2700K CRI>80 □ white	113891
1160lm 2700K CRI>80 ■ matt aluminium	113896
1250lm 3000K CRI>80 ■ matt black	113920
1250lm 3000K CRI>80 □ white	113921
1250lm 3000K CRI>80 ■ matt aluminium	113926

114271 495

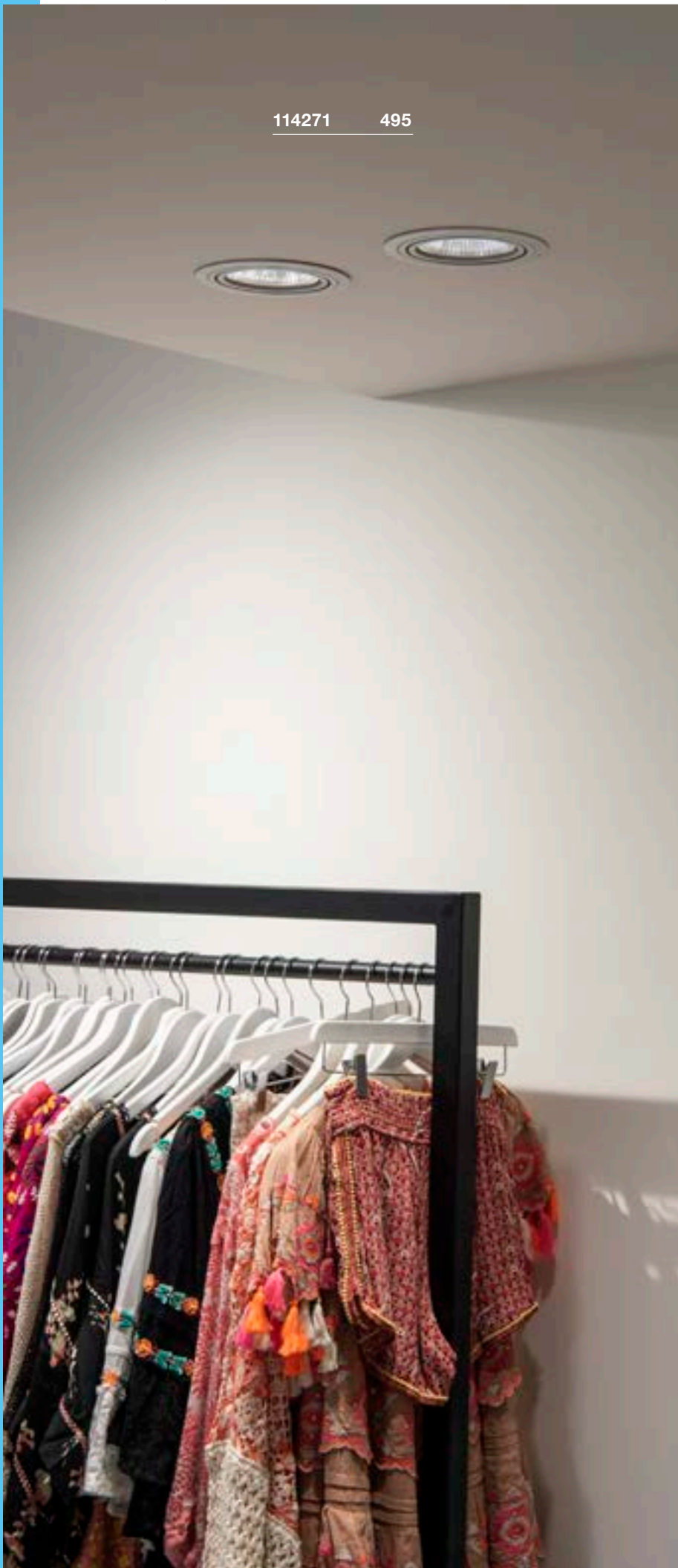

NEW TRIA 110
Single, round, CS, TRIAC

A-A++ Range A++-E



Product details

220-240V ~50/60Hz | 350mA
Total consumption: 15W
Material: Aluminium
Dimmable: Triac C, Triac L

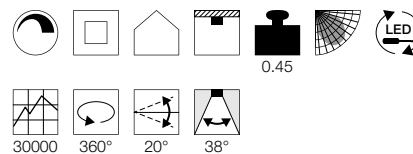

Dimensioned drawing

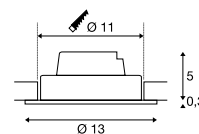

Note

Clip springs
Material thickness, mounting surface: 20 mm max.

Variant	Item no.
1010lm 2700K CRI>80	
■ black	114220
1030lm 2700K CRI>80	
□ white	114221
1100lm 3000K CRI>80	
■ black	114230
1120lm 3000K CRI>80	
□ white	114231

NEW TRIA 110
Single, square, CS, TRIAC



Product details

220-240V ~50/60Hz | 350mA
Total consumption: 15W
Material: Aluminium
Dimmable: Triac C, Triac L

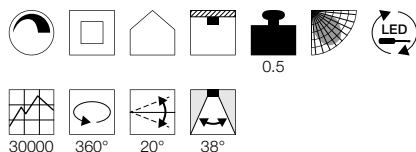

Dimensioned drawing

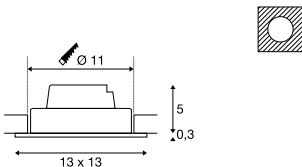

Note

Clip springs
Material thickness, mounting surface: 20 mm max.

Variant	Item no.
1010lm 2700K CRI>80	
■ black	114240
1030lm 2700K CRI>80	
□ white	114241
1100lm 3000K CRI>80	
■ black	114250
1120lm 3000K CRI>80	
□ white	114251

NEW TRIA 150
Single, round, CS, 1-10V



Product details

100-240V ~50/60Hz | 700mA
Total consumption: 29W
Material: Aluminium
Dimmable: 1-10V

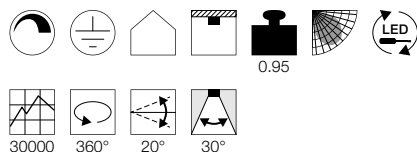

Dimensioned drawing

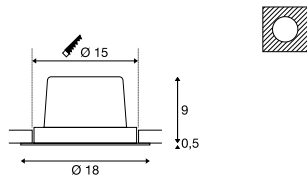

Note

Clip springs
Material thickness, mounting surface: 20 mm max.

Variant	Item no.
2210lm 2700K CRI>80	
■ black	114260
2275lm 2700K CRI>80	
□ white	114261
2425lm 3000K CRI>80	
■ black	114270
2500lm 3000K CRI>80	
□ white	114271

NEW TRIA 150
Single, square, CS, 1-10V



Product details

100-240V ~50/60Hz | 700mA
Total consumption: 29W
Material: Aluminium
Dimmable: 1-10V

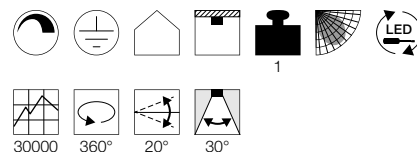

Dimensioned drawing

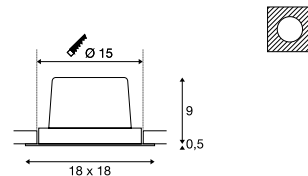

Note

Clip springs
Material thickness, mounting surface: 20 mm max.

Variant	Item no.
2210lm 2700K CRI>80	
■ black	114280
2275lm 2700K CRI>80	
□ white	114281
2425lm 3000K CRI>80	
■ black	114290
2500lm 3000K CRI>80	
□ white	114291

KADUX
EL, single, QPAR51



KADUX
EL, double, QPAR51

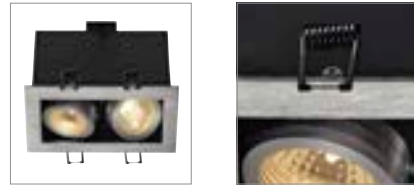

KADUX
EL, triple, QPAR51



Product details

230V ~50Hz
Material: Aluminium / Steel

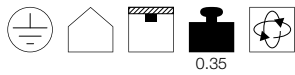

Dimensioned drawing

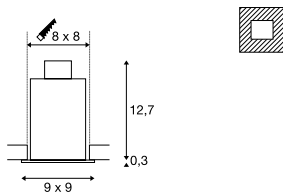

Note

Material thickness, mounting surface: 30 mm max.

Recommended lamp

- LED GU10 5.5W 38°
2700K 400lm EEL=A+
6kWh/1000h
Item no. 1001030
- LED GU10 7.2W 36°
2700K 470lm EEL=A+
8kWh/1000h
Item no. 560542

Lamp details

max. 50W QPAR51

Variant	Item no.
GU10 QPAR51 ■ matt black	115510
GU10 QPAR51 □ matt white	115511
GU10 QPAR51 ■ matt aluminium	115516

Product details

230V ~50Hz
Material: Aluminium / Steel

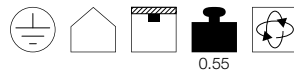

Dimensioned drawing

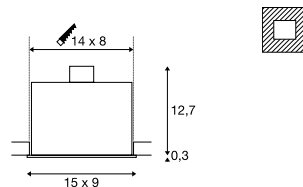

Note

Material thickness, mounting surface: 30 mm max.

Recommended lamp

- GU10 5.5W 36°
2800K 420lm EEL=A+
6kWh/1000h
Item no. 1001217
- LED GU10 5.6W 60°
2200-6700K 350lm EEL=A+
6kWh/1000h
Item no. 1001919

Lamp details

2x max. 50W QPAR51

Variant	Item no.
GU10 QPAR51 ■ matt black	115520
GU10 QPAR51 □ matt white	115521
GU10 QPAR51 ■ matt aluminium	115526

Product details

230V ~50Hz
Material: Aluminium / Steel

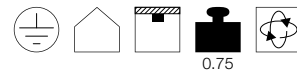

Dimensioned drawing

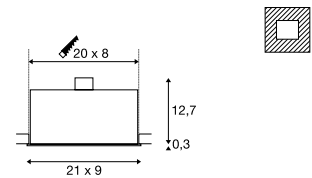

Note

Material thickness, mounting surface: 30 mm max.

Recommended lamp

- LED GU10 7.2W 36°
4000K 540lm EEL=A+
8kWh/1000h
Item no. 1001566
- LED GU10 7.2W 36°
3000K 520lm EEL=A+
8kWh/1000h
Item no. 1001563

Lamp details

3x max. 50W QPAR51

Variant	Item no.
GU10 QPAR51 ■ matt black	115530
GU10 QPAR51 □ matt white	115531
GU10 QPAR51 ■ matt aluminium	115536



115521 496

KADUX
EL, single, QPAR111

E-A++ Range A++-E

Icons: Home with +, Energy efficiency, Light color, Material finish



Product details

230V ~50Hz
Material: Aluminium / Steel

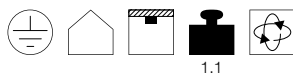

1.1

Dimensioned drawing

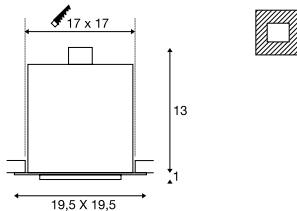

Note

Material thickness, mounting surface: 25 mm max.

Recommended lamp

LED GU10 10W 38°
3000K 630lm EEL=A+
10kWh/1000h
Item no. 1001029



LED GU10 7W 13°
3000K 660lm EEL=A+
8kWh/1000h
Item no. 1001568



Lamp details

max. 75W QPAR111

Variant	Item no.
GU10 QPAR111	
■ matt black	115540
□ matt white	115541
■ matt aluminium	115546



115536 496

KADUX
EL, double, QPAR111

E-A++ Range A++-E

Icons: Home with +, Energy efficiency, Light color, Material finish



Product details

230V ~50Hz
Material: Aluminium / Steel

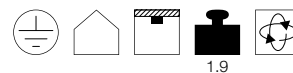

1.9

Dimensioned drawing

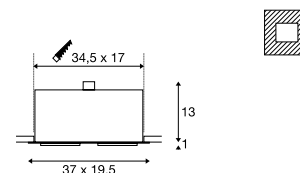

Note

Material thickness, mounting surface: 25 mm max.

Recommended lamp

GU10 9W 25°
2700-6500K 765lm EEL=A+
9kWh/1000h
Item no. 1001920



LED GU10 9W 40°
2700-6500K 765lm EEL=A+
9kWh/1000h
Item no. 1001921



Lamp details

2x max. 75W QPAR111

Variant	Item no.
GU10 QPAR111	
■ matt black	115550
□ matt white	115551
■ matt aluminium	115556

KADUX
EL, single, TRIAC

A-A++ Range A++-E

LED INSIDE



KADUX
EL, double, TRIAC

A-A++ Range A++-E

LED INSIDE



KADUX
EL, triple, TRIAC

A-A++ Range A++-E

LED INSIDE



Product details

220-240V ~50/60Hz | 350mA
Total consumption: 7.5W
Material: Aluminium / Steel
Dimmable: Triac C, Triac L

0.4

40000 38°

Dimensioned drawing

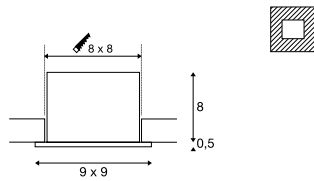

Note

Material thickness, mounting surface: 30 mm max.

Product details

220-240V ~50/60Hz | 350mA
Total consumption: 14W
Material: Aluminium / Steel
Dimmable: Triac C, Triac L

0.6

40000 38°

Dimensioned drawing

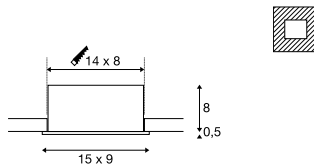

Note

Material thickness, mounting surface: 30 mm max.

Product details

220-240V ~50/60Hz | 350mA
Total consumption: 20W
Material: Aluminium / Steel
Dimmable: Triac C, Triac L

0.75

40000 38°

Dimensioned drawing

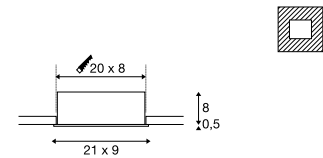

Note

Material thickness, mounting surface: 30 mm max.

Variant	Item no.
650lm 3000K CRI>80 ■ matt black	115700
650lm 3000K CRI>80 □ matt white	115701
650lm 3000K CRI>80 ■ matt aluminium	115706

Variant	Item no.
1290lm 3000K CRI>80 ■ matt black	115710
1290lm 3000K CRI>80 □ matt white	115711
1290lm 3000K CRI>80 ■ matt aluminium	115716

Variant	Item no.
1920lm 3000K CRI>80 ■ matt black	115720
1920lm 3000K CRI>80 □ matt white	115721
1920lm 3000K CRI>80 ■ matt aluminium	115726



115700 498



115711 498

KADUX
EL, single, 1-10V

A-A++ Range A++-E

LED INSIDE



KADUX
EL, double, 1-10V

A-A++ Range A++-E

LED INSIDE



Product details

100-240V ~50/60Hz | 700mA
Total consumption: 29W
Material: Aluminium / Steel
Dimmable: 1-10V

1.6

30000 30°

Dimensioned drawing

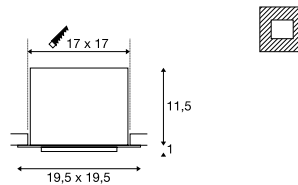

Note

Material thickness, mounting surface: 25 mm max.

Recommended accessories

1-10V dimming
Item no. 470505

Variant	Item no.
2425lm 3000K CRI>80 ■ matt black	115730
2500lm 3000K CRI>80 □ matt white	115731
2500lm 3000K CRI>80 ■ matt aluminium	115736

Product details

100-240V ~50/60Hz | 1400mA
Total consumption: 54W
Material: Aluminium / Steel
Dimmable: 1-10V

2.8

30000 30°

Dimensioned drawing

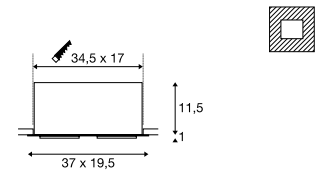

Note

Material thickness, mounting surface: 25 mm max.

Recommended accessories

1-10V dimming
Item no. 470505

Variant	Item no.
5200lm 3000K CRI>80 ■ matt black	115740
5300lm 3000K CRI>80 □ matt white	115741
5300lm 3000K CRI>80 ■ matt aluminium	115746

AIXLIGHT® PRO 50
LED module



A-A++ Range A+-E



LED INSIDE

NEW VARIANT



AIXLIGHT® PRO 50
QPAR51 Module



E-A++ Range A+-E



Product details

350mA | 13.3W
Material: Aluminium / Glass

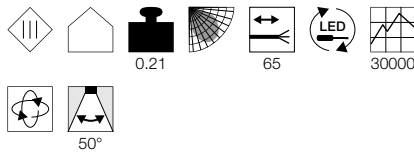

Dimensioned drawing

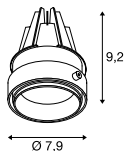

Note

Driver excl.
Open cable end

Product details

230V ~50Hz
Material: Aluminium / Plastic



Dimensioned drawing

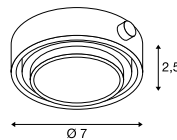

Recommended lamp

LED GU10 7.2W 36°
4000K 540lm EEL=A+
8kWh/1000h
Item no. 1001566



LED GU10 5.1W 48°
2700-6500K 350lm EEL=A+
6kWh/1000h
Item no. 1001918



Lamp details

max. 50W QPAR51
Ø: 5 cm max. L: 5.7 cm max.

Variant	Item no.
1150lm 3000K CRI>80 ■ white / black	1002598
1150lm 3000K CRI>80 ■ grey / black	1002599
1185lm 4000K CRI>80 ■ white / black	1002600
1185lm 4000K CRI>80 ■ grey / black	1002601

Variant	Item no.
GU10 QPAR51 ■ grey / black	115414

AIXLIGHT® PRO 50
1 FRAME

Steel
L: 10 cm W: 10 cm D: 10 cm
Weight: 0.33 kg
1 pc.



Variant	Item no.
■ grey / black	115304

AIXLIGHT® PRO 50
2 FRAME

Steel
L: 17.3 cm W: 10 cm D: 10 cm
Weight: 0.45 kg
1 pc.



Variant	Item no.
■ grey / black	115314

AIXLIGHT® PRO 50
1 FRAMELESS

Steel
L: 10.2 cm W: 10.2 cm D: 10.5 cm
Weight: 0.77 kg
1 pc.



Variant	Item no.
■ black	115351

AIXLIGHT® PRO 50
2 FRAMELESS

Steel
L: 18.8 cm W: 10.2 cm D: 10.5 cm
Weight: 1.09 kg
1 pc.

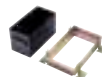

Variant	Item no.
■ black	115352



AIXLIGHT® PRO
EL, QPAR111 Module



E-A++ Range A++-E

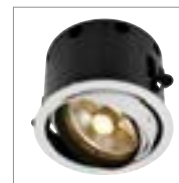

Product details

230V ~50Hz
Material: Aluminium / Plastic



Dimensioned drawing

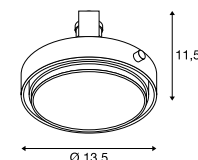

AIXLIGHT® PRO
1 FRAME

Steel
L: 17.5 cm W: 17.5 cm D: 19 cm
Weight: 1 kg
1 pc.



Variant	Item no.
■ grey / black	115104

AIXLIGHT® PRO
2 FRAME

Steel
L: 31.5 cm W: 17.5 cm D: 19 cm
Weight: 1.45 kg
1 pc.



Variant	Item no.
■ grey / black	115114

AIXLIGHT® PRO
1 FRAMELESS

Steel
L: 15.5 cm W: 15.5 cm D: 18.5 cm
Weight: 2.15 kg
1 pc.



Variant	Item no.
■ black	115151

AIXLIGHT® PRO
2 FRAMELESS

Steel
L: 31.5 cm W: 15.5 cm D: 18.5 cm
Weight: 3.5 kg
1 pc.



Variant	Item no.
■ black	115152

AIXLIGHT® PRO
1 FRAMELESS

Steel / Steel
Ø: 15.5 cm D: 12 cm
Weight: 0.78 kg
1 pc.



Variant	Item no.
■ black	115624

AIXLIGHT® PRO
2 FRAMELESS

Steel / Steel
L: 32.5 cm W: 15.5 cm D: 12 cm
Weight: 1.72 kg
1 pc.



Variant	Item no.
■ black	115634

Recommended accessories

- Trim panel
- Item no. 115600**
- Structured glass
- Item no. 115170**

Recommended lamp

- LED GU10 13W 140°
4000K 1100lm EEL=A+
13kWh/1000h
Item no. 1001245
- LED GU10 9W 40°
2700-6500K 765lm EEL=A+
9kWh/1000h
Item no. 1001921

Lamp details

max. 75W QPAR111

Variant	Item no.
GU10 QPAR111 <input type="checkbox"/> matt white	115011
GU10 QPAR111 <input checked="" type="checkbox"/> grey / black	115014

AIXLIGHT® PRO
EL, COB LED module

883

A-A++ Range A+-E



Product details

700mA/1000mA/1050mA | 39W
Material: Aluminium / Glass



Dimensioned drawing

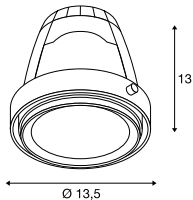

Note

Différentes tensions possibles. 700mA, 25W, 2400lm – 1000/1050mA, 39W, 32000lm.
In our Smart Home Solutions chapter, you will find different VALETO® accessories to suit your choice of transformer.

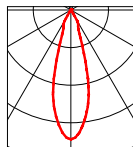

115203
115233

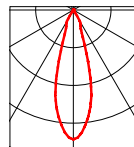

115213
115243

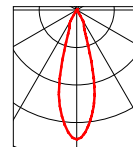

115223
115253

Recommended accessories

- LED driver 700mA | 40W incl. strain relief
Item no. 464168
- LED driver 350-1050mA | 50W | Dali 1-10V dimmable
Item no. 464032
- LED driver 1050mA | 40W Triac trailing edge dimmable
Item no. 464804
- LED driver 1000mA | 40W incl. strain relief
Item no. 464170
- LED driver 350-1050mA | 50W | Dali 1-10V dimmable
Item no. 464032
- Trim panel
Item no. 115600

Variant	Item no.
2700/3500lm 3000K CRI>80 30°	
□ matt white	115183
2700/3500lm 3000K CRI>80 30°	
■ grey / black	115193

115104 + 115213 501 + 503



AIXLIGHT® PRO
EL, COB LED module



A-A++ Range A++-E



- Premium LED with CRI>90
- Lighting for fresh produce and clothing

Product details

700mA | 26W
Material: Aluminium / Glass



Dimensioned drawing

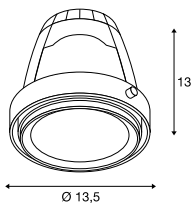

Note

In our Smart Home Solutions chapter, you will find different VALETO® accessories to suit your choice of transformer.

Recommended accessories

- LED driver 700mA | 40W incl. strain relief
Item no. 464168
- LED driver 350-1050mA | 50W | DALI 1-10V dimmable
Item no. 464032
- Trim panel
Item no. 115600

Variant	Item no.
1950lm 4200K CRI>90 30° white / black	115203
1950lm 4200K CRI>90 30° grey / black	115233

AIXLIGHT® PRO
EL, COB LED module



A-A++ Range A++-E



- Lighting for meat products

Product details

700mA | 26W
Material: Aluminium / Glass



Dimensioned drawing

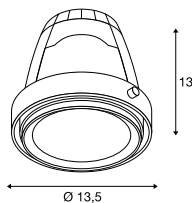

Note

This product is not suitable for general room lighting, since it is a specialised product for illuminating meat.
In our Smart Home Solutions chapter, you will find different VALETO® accessories to suit your choice of transformer.
Colour coordinates: X=0.3759 Y=0.3287

Recommended accessories

- LED driver 700mA | 40W incl. strain relief
Item no. 464168
- LED driver 350-1050mA | 50W | DALI 1-10V dimmable
Item no. 464032
- Trim panel
Item no. 115600

Variant	Item no.
1300lm 3600K CRI>65 30° white / black	115213
1300lm 3600K CRI>65 30° grey / black	115243

AIXLIGHT® PRO
EL, COB LED module



A-A++ Range A++-E



- Premium LED with CRI>90
- Lighting for baked goods

Product details

700mA | 26W
Material: Aluminium / Glass



Dimensioned drawing

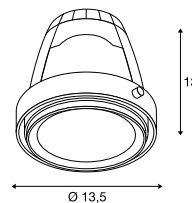

Note

In our Smart Home Solutions chapter, you will find different VALETO® accessories to suit your choice of transformer.

Recommended accessories

- LED driver 700mA | 40W incl. strain relief
Item no. 464168
- LED driver 350-1050mA | 50W | DALI 1-10V dimmable
Item no. 464032
- Trim panel
Item no. 115600

Variant	Item no.
1650lm 3200K CRI>90 30° white / black	115223
1650lm 3200K CRI>90 30° grey / black	115253

SUPROS 78
EL, TRIAC

897

A-A++ Range
A++-E

Product details

220-240V ~50/60Hz | 250mA
 Total consumption: 12W
 Material: Aluminium
 Dimmable: Triac C, Triac L

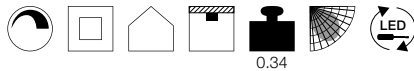

0,34

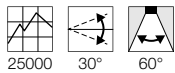

25000

30°

60°

Dimensioned drawing

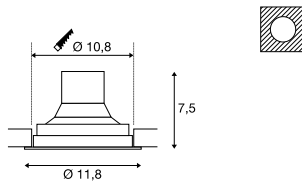

Note

Material thickness, mounting surface: 25 mm max.

Recommended accessories

Lens, 20°

Item no. 116302

Lens, 40°

Item no. 116304

Variant	Item no.
700lm 3000K CRI>80	
■ black	116310
700lm 3000K CRI>80	
□ white	116311



116311 504

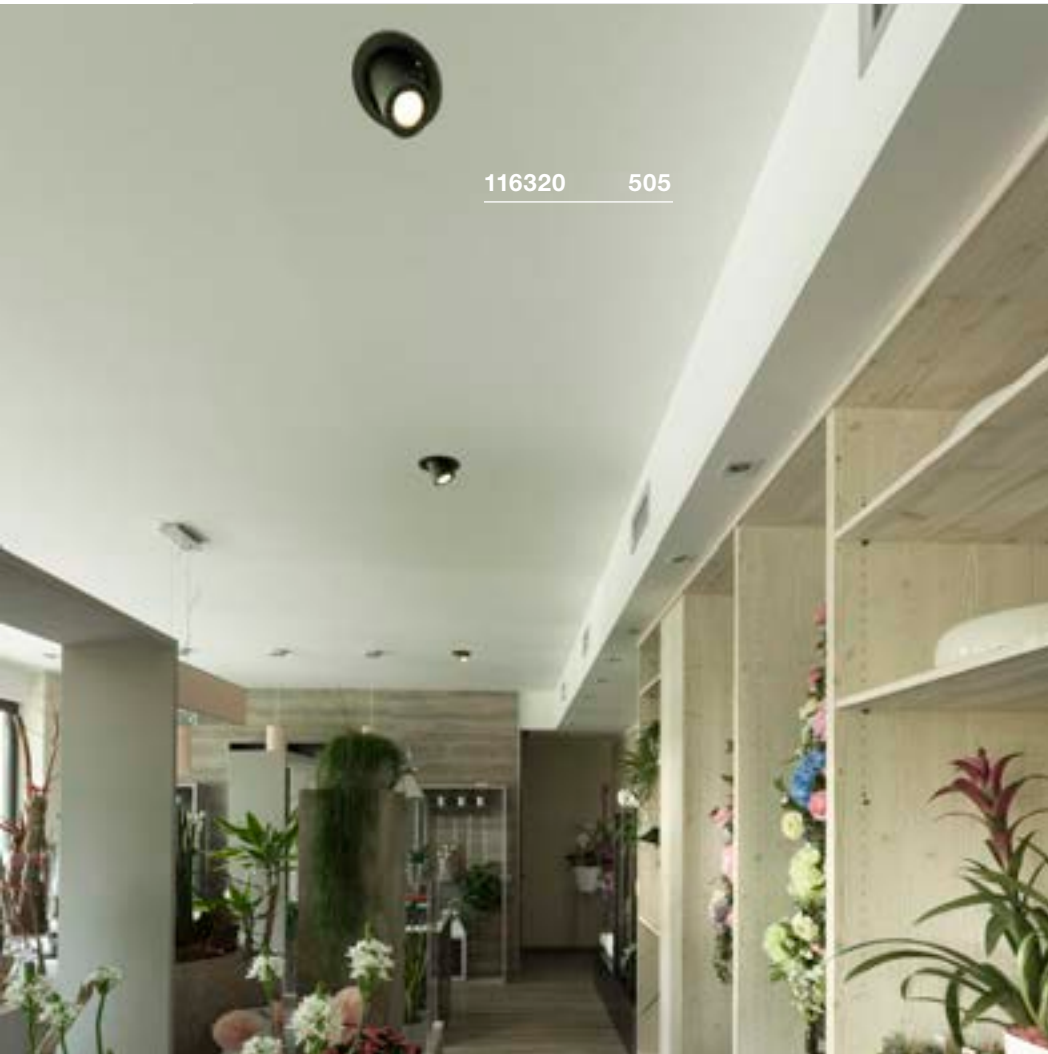

116320 505

SUPROS 78
EL, Move, TRIAC



A-A++ Range A++-E



Product details

220-240V ~50/60Hz | 250mA
Total consumption: 12W
Material: Aluminium
Dimmable: Triac C, Triac L

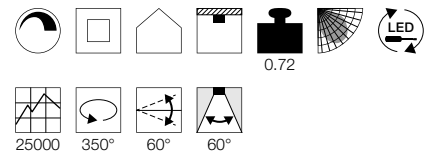

Dimensioned drawing

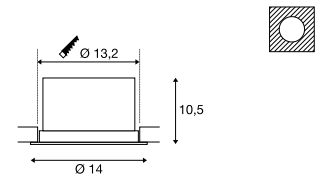

Note

Material thickness, mounting surface: 25 mm max.

Recommended accessories

Lens, 20°
Item no. 116302
Lens, 40°
Item no. 116304

Variant	Item no.
700lm 3000K CRI>80	
■ black	116320
700lm 3000K CRI>80	
□ white	116321



116310 504

SUPROS
EL

897

A-A++ Range
A++-E

Product details

220-240V ~50/60Hz | 950mA
Material: Aluminium / Glass

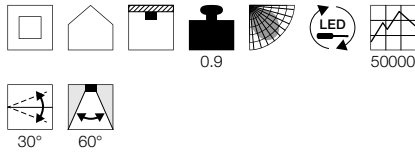

Dimensioned drawing

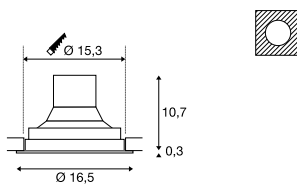

Note

Material thickness, mounting surface: 25 mm max.

Recommended accessories

Reflec or 20°

Item no. 114102



Reflec or 40°

Item no. 114104



Variant	Item no.
2600lm 3000K CRI>80 31W	
■ black	114110
2600lm 3000K CRI>80 31W	
□ white	114111
3100lm 3000K CRI>80 36W	
■ black	118110
3100lm 3000K CRI>80 36W	
□ white / transparent	118111
2850lm 4000K CRI>80 31W	
■ black	114160
2850lm 4000K CRI>80 31W	
□ white / transparent	114161
3300lm 4000K CRI>80 36W	
■ black	118160
3300lm 4000K CRI>80 36W	
□ white / transparent	118161





114121 507

SUPROS
EL, Move



A-A++ Range A++-E



Product details

220-240V ~50/60Hz | 950mA
Material: Aluminium / Glass

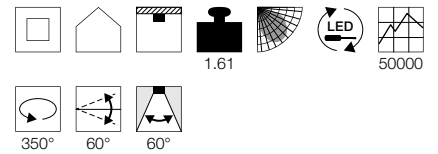

Dimensioned drawing

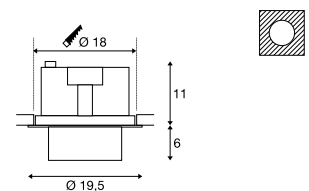

Note

Material thickness, mounting surface: 25 mm

Recommended accessories

- Reflec or 20°
- Item no. 114102
- Reflec or 40°
- Item no. 114104

Variant	Item no.
2600lm 3000K CRI>80 31W	
■ black	114120
2600lm 3000K CRI>80 31W	
□ white	114121
3100lm 3000K CRI>80 36W	
■ black	118120
3100lm 3000K CRI>80 36W	
□ white / transparent	118121
2850lm 4000K CRI>80 31W	
■ black	114170
2850lm 4000K CRI>80 31W	
□ white / transparent	114171
3300lm 4000K CRI>80 36W	
■ black	118170
3300lm 4000K CRI>80 36W	
□ white / transparent	118171

GIMBLE IN 68 EL

A-A++ Range A++-E

LED INSIDE

NEW

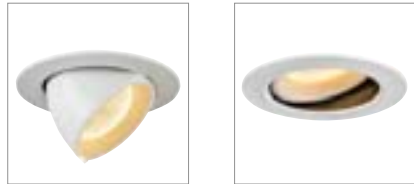

- Premium LED with CRI>90
- Rotating and tilting light outlet

Product details

350mA | 6W
Material: Aluminium

Dimensioned drawing

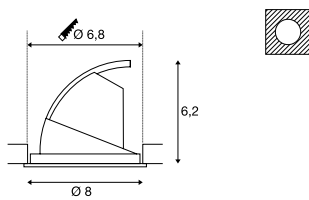

Note

Material thickness, mounting surface: 20 mm

Recommended accessories

LED driver 350mA | 10W
Item no. 464140

GIMBLE IN 100 EL

A-A++ Range A++-E

LED INSIDE

NEW



- Premium LED with CRI>90
- Rotating and tilting light outlet

Product details

350mA | 13W
Material: Aluminium

Dimensioned drawing

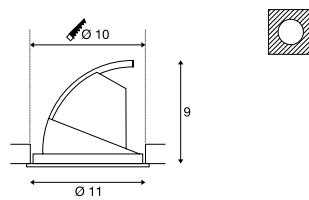

Note

Material thickness, mounting surface: 25 mm

Recommended accessories

LED driver 350mA | 15W
Item no. 464031

GIMBLE IN 150 EL

A-A++ Range A++-E

LED INSIDE

NEW



- Premium LED with CRI>90
- Rotating and tilting light outlet

Product details

700mA | 25.5W
Material: Aluminium

Dimensioned drawing

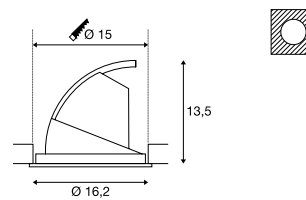

Note

Material thickness, mounting surface: 30 mm

Recommended accessories

LED driver 40W | 700mA | 1-10V/
DALI dimmable, incl. strain relief
Item no. 1002424

Variant	Item no.
520lm 3000K CRI>90 □ matt white	1002879
560lm 4000K CRI>90 □ matt white	1002885

Variant	Item no.
990lm 3000K CRI>90 □ matt white	1002880
1140lm 4000K CRI>90 □ matt white	1002886

Variant	Item no.
2300lm 3000K CRI>90 □ matt white	1002888
2490lm 4000K CRI>90 □ matt white	1002889

GIMBLE IN 175 EL

A-A++ Range
A++-E

LED
INSIDE

NEW



- Premium LED with CRI>90
- Rotating and tilting light outlet

Product details

1000mA/1050mA | 38W
Material: Aluminium

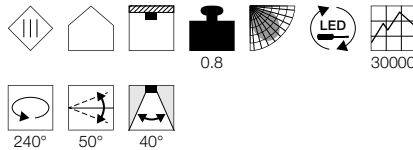

Dimensioned drawing

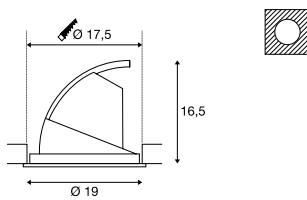

Note

Material thickness, mounting surface: 30 mm

Recommended accessories

LED driver 1000mA | 40W | TRIAC dimmable, incl. strain relief

Item no. 1001115

LED driver 50W | 1050mA | 1-10V/ DALI dimmable, incl. strain relief

Item no. 1002425

Variant	Item no.
3340lm 3000K CRI>90	
<input type="checkbox"/> matt white	1002881
3550lm 4000K CRI>90	
<input type="checkbox"/> matt white	1002887

1002880 508



SENSER 12
EL, round



A-A++ Range A++-E

- Shallow installation depth

Product details

Material: Aluminium

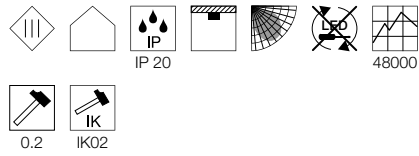

SENSER 12
EL, round



SENSER 18
EL, round



SENSER 24
EL, round



Variant	Item no.
470lm 3000K CRI>80 200mA 6W Ø: 11.5 cm H: 2 cm 0.1 kg <input type="checkbox"/> matt white	1003008

Variant	Item no.
950lm 3000K CRI>80 350mA 9.7W Ø: 16.5 cm H: 2 cm 0.18 kg <input type="checkbox"/> matt white	1003009

Variant	Item no.
1200lm 3000K CRI>80 500mA 12.5W Ø: 21.5 cm H: 2 cm 0.29 kg <input type="checkbox"/> matt white	1003010



SENSER 12
EL, square



A-A++ Range A++-E

- Shallow installation depth

Product details

Material: Aluminium

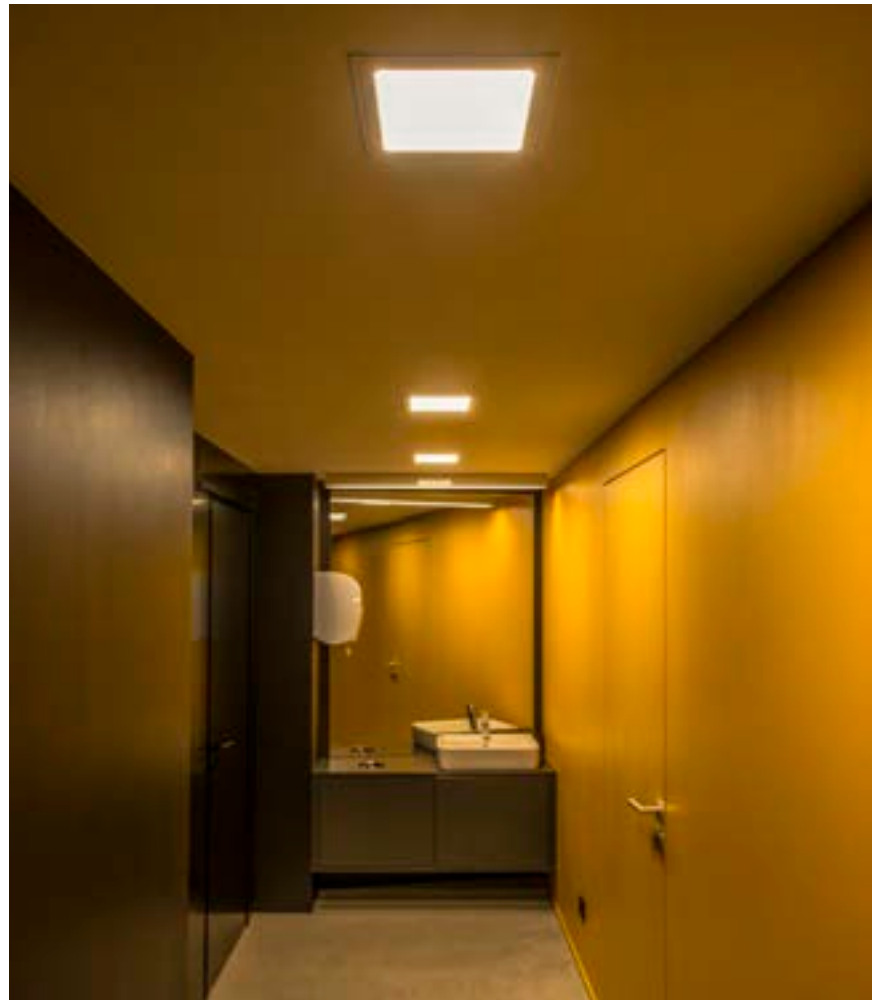
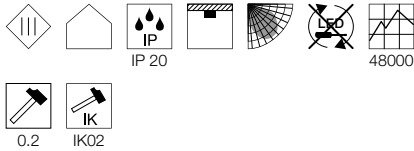

SENSER 12
EL, square



Variant	Item no.
440lm 3000K CRI>80 200mA 6W L: 11.5 cm W: 11.5 cm H: 2 cm 0.12 kg □ matt white	1003011

SENSER 18
EL, square



Variant	Item no.
820lm 3000K CRI>80 350mA 9.7W L: 16.5 cm W: 16.5 cm H: 2 cm 0.22 kg □ matt white	1003012

SENSER 24
EL, square



Variant	Item no.
1200lm 3000K CRI>80 500mA 12.5W L: 21.5 cm W: 21.5 cm H: 2 cm 0.36 kg □ matt white	1003013

VERLUX
EL, square, TRIAC

A-A++ Range
A++-E



Product details

220-240V ~50/60Hz | 500mA
Total consumption: 12W
Material: Aluminium / Plastic
Dimmable: Triac C, Triac L

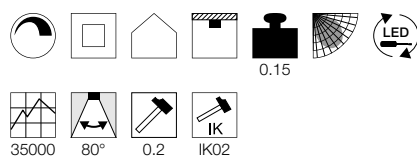

Dimensioned drawing

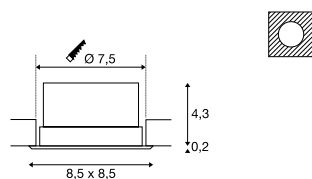

Note

Material thickness, mounting surface: 30 mm max.
Can be integrated in the VALETO® with VALETO®
Switch Box 420012.

Variant	Item no.
880lm 3000K CRI>80 □ matt white	112682

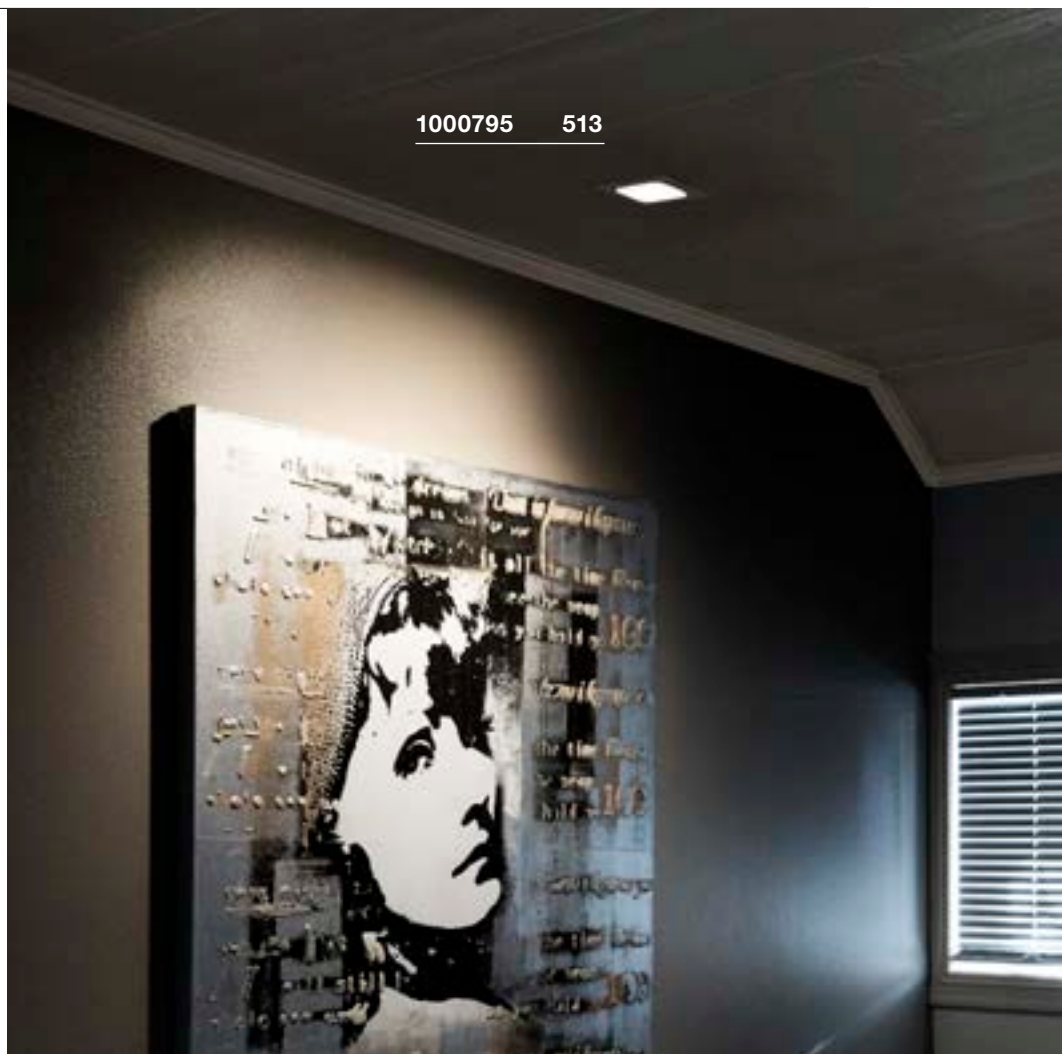

1000795 513



112702 513

VERLUX
EL, square, TRIAC

A-A++ Range A++-E



Product details

220-240V ~50/60Hz | 500mA
Total consumption: 22W
Material: Aluminium / Plastic
Dimmable: Triac C, Triac L

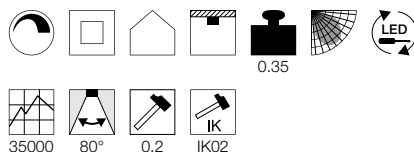

Dimensioned drawing

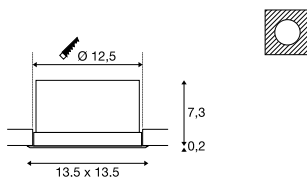

Note

Material thickness, mounting surface: 30 mm max.
Can be integrated in the VALETO® with VALETO® Switch Box 420012.

Variant	Item no.
1800lm 3000K CRI>80 □ matt white	112692

VERLUX
EL, square, TRIAC

A-A++ Range A++-E



Product details

220-240V ~50/60Hz | 700mA
Total consumption: 31W
Material: Aluminium / Plastic
Dimmable: Triac C, Triac L

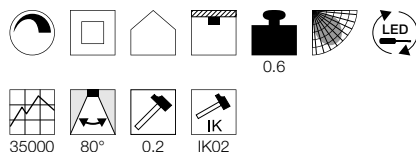

Dimensioned drawing

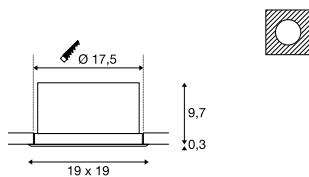

Note

Material thickness, mounting surface: 30 mm max.
Can be integrated in the VALETO® with VALETO® Switch Box 420012.

Variant	Item no.
2360lm 3000K CRI>80 □ matt white	112702

VERLUX
EL, square, TRIAC

A-A++ Range A++-E



Product details

220-240V ~50/60Hz | 350mA
Material: Aluminium / Plastic
Dimmable: Triac C, Triac L

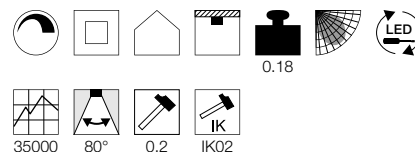

Dimensioned drawing

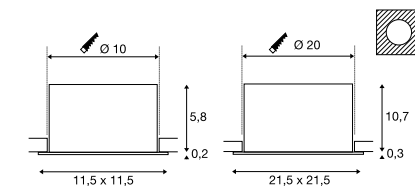

Note

Material thickness, mounting surface: 25 mm max.

Variant	Item no.
650lm 3000K CRI>80 8,6W L: 11.5 cm W: 11.5 cm H: 6 cm □ white	1000795
1370lm 3000K CRI>80 16W L: 21.5 cm W: 21.5 cm H: 11 cm □ white	1000796

- Asymmetrical light emission

RILO
ELA-A++ Range
A++-ELED
INSIDE

- Premium LED with CRI>90
- Colour temperature (3000K/4000K) selectable using switch
- UGR<19

Product details

220-240V ~50/60Hz

Material: Aluminium / Polycarbonate (PC)

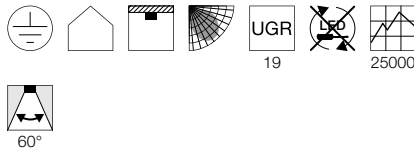

Dimensioned drawing

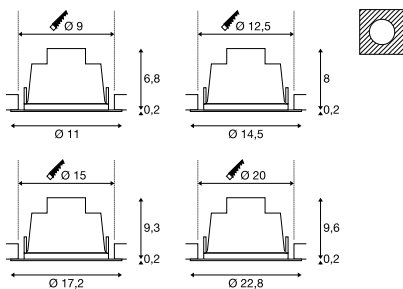

Note

Colour temperature can be adjusted during installation via a switch attached to the luminaire.
Material thickness, mounting surface: 35 mm

Variant	Item no.
350/400lm 3000/4000K CRI>90 6W diam.: 11 cm 0.16 kg white / chrome	1001973
800/850lm 3000/4000K CRI>90 13W diam.: 14.5 cm 0.26 kg white / chrome	1001974
1200/1300lm 3000/4000K CRI>90 18W diam.: 17.2 cm 0.36 kg white / chrome	1001975
1550/1600lm 3000/4000K CRI>90 21W diam.: 22.8 cm 0.56 kg white / chrome	1001976

1001976 514

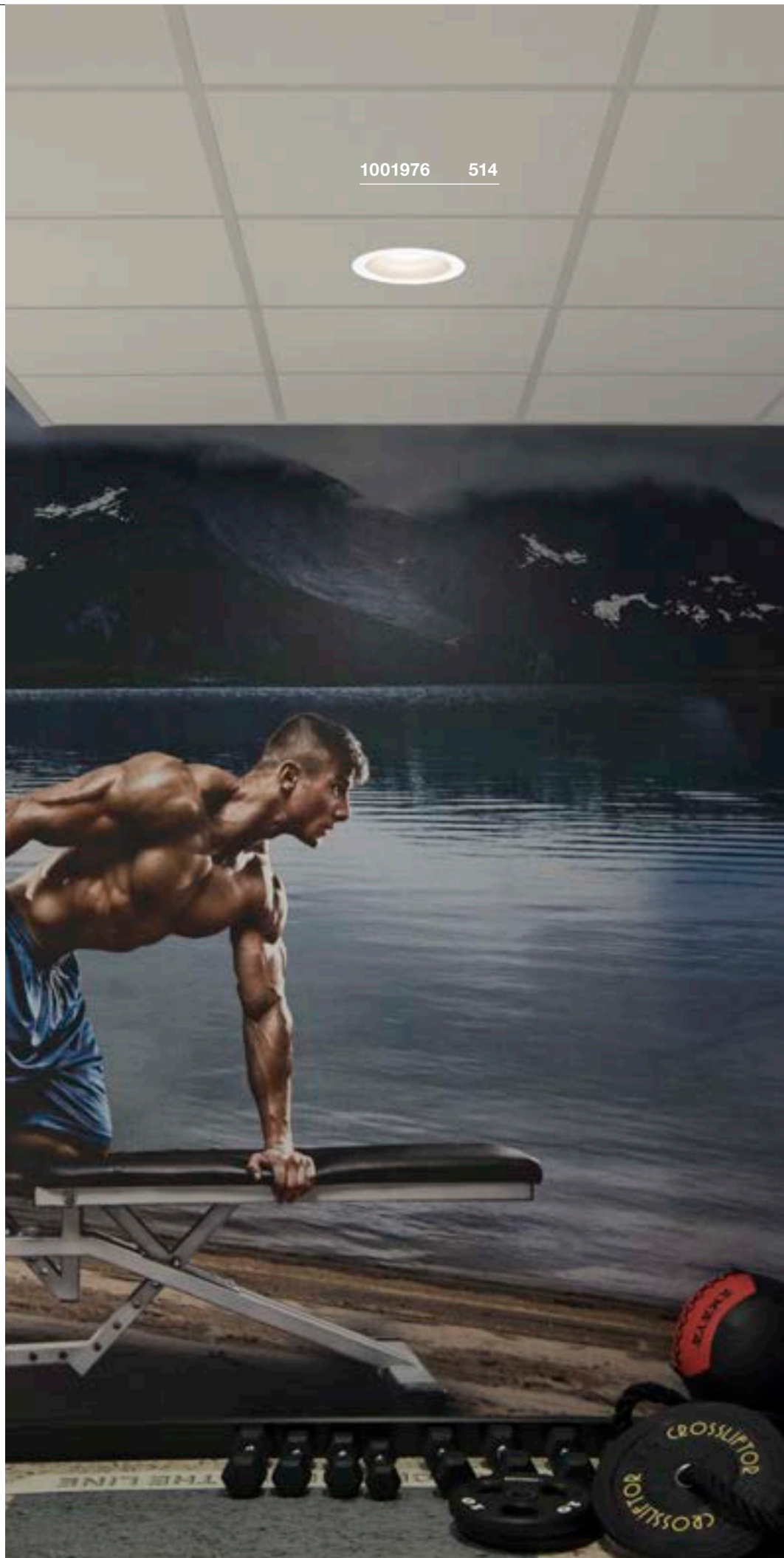

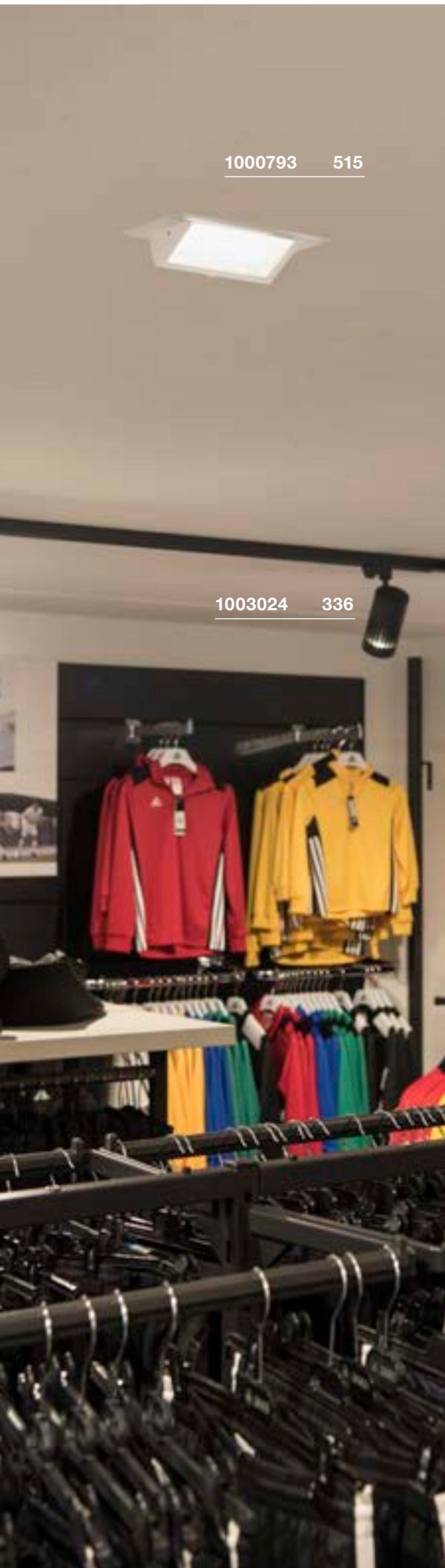

1000793 515

1003024 336

ALAMEA
EL

A-A++ Range A++-E



- Premium LED with CRI>90
- Extensive tilting range

Product details

Material: Aluminium/Glass

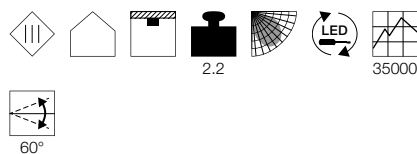

Dimensioned drawing

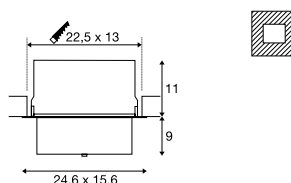

Note

Material thickness, mounting surface: 40 mm max.

Recommended accessories

■ LED driver 1000mA | 40W incl. strain relief
Item no. 464170

□ LED driver 350-1050mA | 50W | DALI 1-10V dimmable
Item no. 464032

□ LED driver 1000mA | 40W | TRIAC dimmable, incl. strain relief
Item no. 1001115



ALAMEA
EL

A-A++ Range A++-E



- Premium LED with CRI>90
- Extensive tilting range

Product details

Material: Aluminium/Glass

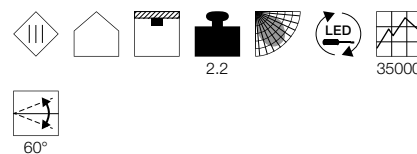

Dimensioned drawing

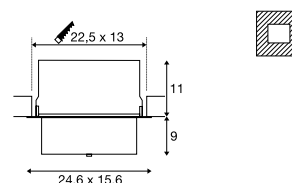

Note

Material thickness, mounting surface: 40 mm max.

Recommended accessories

■ LED driver 700mA | 40W incl. strain relief
Item no. 464168

□ LED driver 350-1050mA | 50W | DALI 1-10V dimmable
Item no. 464032

□ LED driver 700mA | 40W | TRIAC dimmable, incl. strain relief
Item no. 1001114



Variant	Item no.
2900lm 700mA 29.4W 3000K CRI>90	
□ white	1000791
3600lm 1000mA 36W 3000K CRI>90	
□ white	1000792

Variant	Item no.
2750lm 700mA 29.4W 4000K CRI>90	
□ white	1000793
3800lm 1000mA 36W 4000K CRI>90	
□ white	1000794

1000388 517

143440 391

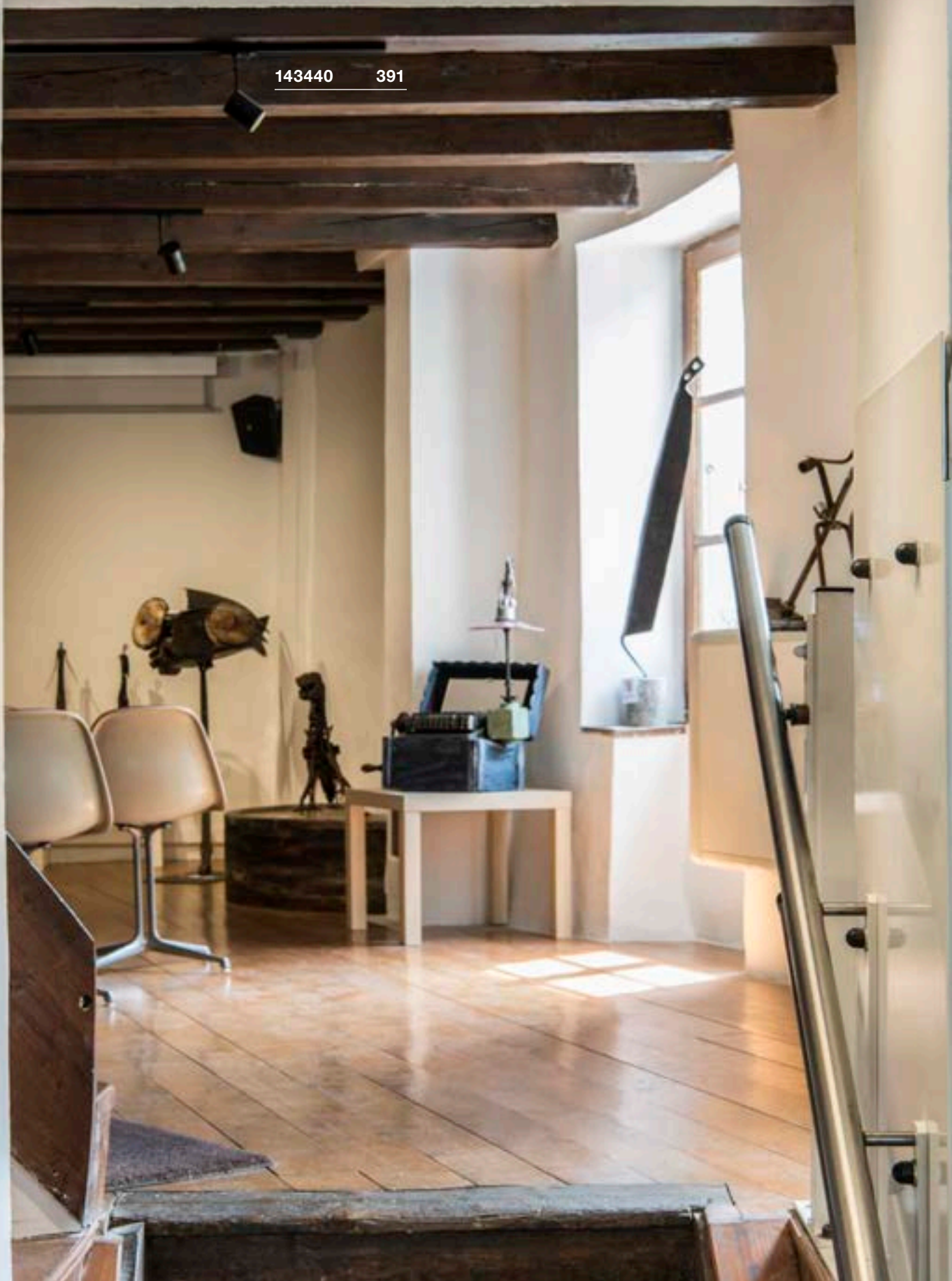

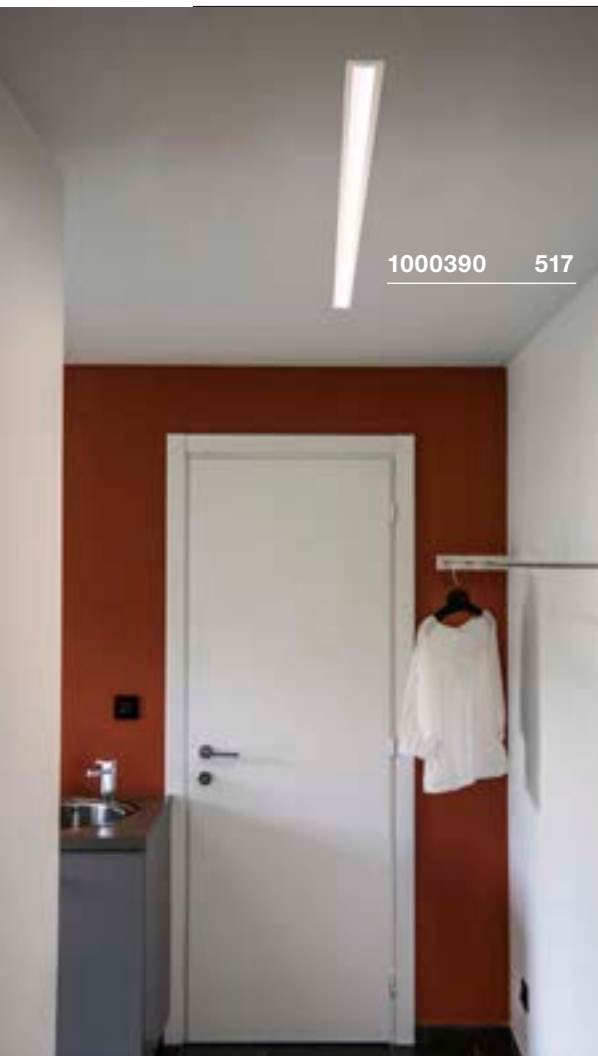

1000390 517



1000390 517

ANINDA 60 EL

A-A++ Range A++-E

LED INSIDE



- Material thickness, mounting surface: 15 mm max.
- Other drivers on request.

Product details

700mA | 16W
Material: Aluminium / Acrylic

1.05 90°

Dimensioned drawing

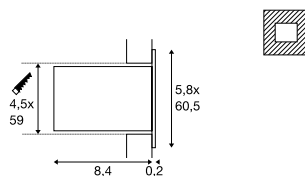

Note

Material thickness, mounting surface: 15 mm

Recommended accessories

- LED driver 350-1050mA | 50W | Dali 1-10V dimmable
Item no. 464032
- LED driver 25W | 700mA | Triac dimmable | incl. strain relief
Item no. 1001133
- LED driver 20W | 700mA
Item no. 1001136

Variant	Item no.
1040lm 3000K CRI>80	
■ matt black	1000386
1040lm 3000K CRI>80	
□ matt white	1000387
1040lm 3000K CRI>80	
■ grey	1000388

ANINDA 120 EL

A-A++ Range A++-E

LED INSIDE



- Material thickness, mounting surface: 15 mm max.
- Other drivers on request.

Product details

700mA | 16W
Material: Aluminium / Acrylic

1.95 90°

Dimensioned drawing

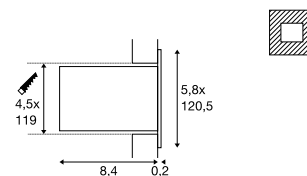

Note

Material thickness, mounting surface: 15 mm max.
Other drivers by request.

Recommended accessories

- LED driver 350-1050mA | 50W | Dali 1-10V dimmable
Item no. 464032
- LED driver 35W | 700mA | Triac dimmable | incl. strain relief
Item no. 1001132
- LED driver 700mA | 40W incl. strain relief
Item no. 464168

Variant	Item no.
2230lm 3000K CRI>80	
■ matt black	1000389
2230lm 3000K CRI>80	
□ matt white	1000390
2230lm 3000K CRI>80	
■ grey	1000391

MEDO 30
EL, frameless



A-A++ Range A++-E



- Colour temperature (3000K/4000K) selectable using a switch

Product details

350mA | 14W
Material: Aluminium / Polymethylacrylate (PMMA)

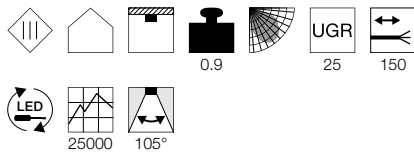

Dimensioned drawing

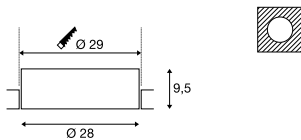

Note

Open cable end
Material thickness, mounting surface: 45 mm

Recommended accessories

- LED driver 20W | 350mA | incl. strain relief
Item no. 1002420
- LED driver 20W | 350mA | 1-10V/DALI dimmable, incl. strain relief
Item no. 1002423
- LED driver 20W | 350mA | TRIAC dimmable, incl. strain relief
Item no. 1002232

Variant	Item no.
1500/1600lm 3000/4000K CRI>80 <input type="checkbox"/> white	1001901



MEDO 40
EL, frameless



A-A++ Range A++-E



- Colour temperature (3000K/4000K) selectable using a switch

Product details

700mA | 18W
Material: Aluminium / Polymethylacrylate (PMMA)
Installation dimensions: D: 13 cm

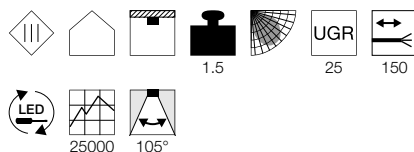

Dimensioned drawing

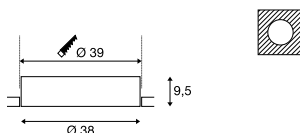

Note

Open cable end
Material thickness, mounting surface: 45 mm

Recommended accessories

- LED driver 700mA | 40W incl. strain relief
Item no. 464168
- LED driver 40W | 700mA | 1-10V/DALI dimmable, incl. strain relief
Item no. 1002424

Variant	Item no.
3100/3300lm 3000/4000K CRI>80	
□ white	1001902

MEDO 60
EL, frameless



A-A++ Range A++-E



- Colour temperature (3000K/4000K) selectable using a switch

Product details

1000mA/1050mA | 28W
Material: Aluminium / Polymethylacrylate (PMMA)
Installation dimensions: D: 16 cm

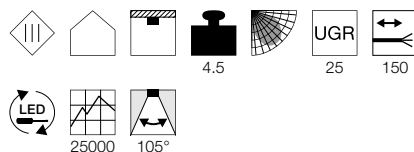

Dimensioned drawing

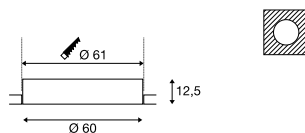

Note

Open cable end
Material thickness, mounting surface: 45 mm

Recommended accessories

- LED driver 60W | 1000mA | incl. strain relief
Item no. 1002422
- LED driver 50W | 1050mA | 1-10V/DALI dimmable, incl. strain relief
Item no. 1002425
- LED driver 1000mA | 40W | TRIAC dimmable, incl. strain relief
Item no. 1001115

Variant	Item no.
4700/5000lm 3000/4000K CRI>80	
□ white	1001903

MEDO 90
EL, frameless



A-A++ Range A++-E

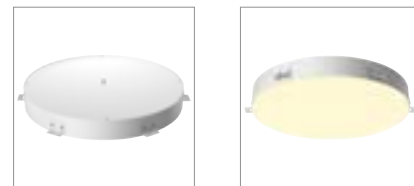

- Colour temperature (3000K/4000K) selectable using a switch

Product details

1000mA/1050mA | 36W
Material: Aluminium / Polymethylacrylate (PMMA)
Installation dimensions: D: 21 cm

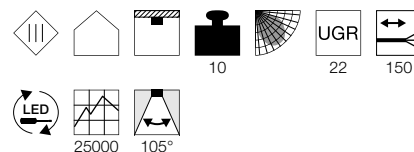

Dimensioned drawing

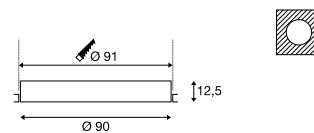

Note

Open cable end
Material thickness, mounting surface: 45 mm

Recommended accessories

- LED driver 60W | 1000mA | incl. strain relief
Item no. 1002422
- LED driver 50W | 1050mA | 1-10V/DALI dimmable, incl. strain relief
Item no. 1002425
- LED driver 1000mA | 40W | TRIAC dimmable, incl. strain relief
Item no. 1001115

Variant	Item no.
9550/10150lm 3000/4000K CRI>80	
□ white	1001904

MEDO 30
EL, installation frame



A-A++ Range A++-E



- Colour temperature (3000K/4000K) selectable using a switch

Product details

350mA | 14W
Material: Aluminium / Polymethylacrylate (PMMA)
Installation dimensions: D: 13 cm

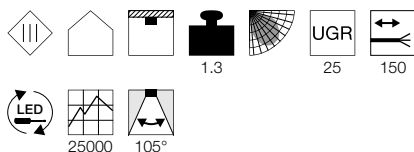

Dimensioned drawing

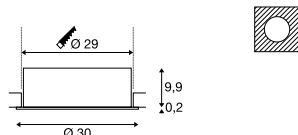

Note

Open cable end
Material thickness, mounting surface: 10-35 mm

Recommended accessories

- LED driver 20W | 350mA | incl. strain relief
Item no. 1002420
- LED driver 20W | 350mA | 1-10V/DALI dimmable, incl. strain relief
Item no. 1002423
- LED driver 20W | 350mA | TRIAC dimmable, incl. strain relief
Item no. 1002232

Variant	Item no.
1500/1600lm 3000/4000K CRI>80	
□ white	1001905

MEDO 40
EL, installation frame



A-A++ Range A++-E



- Colour temperature (3000K/4000K) selectable using a switch

Product details

700mA | 18W
Material: Aluminium / Polymethylacrylate (PMMA)
Installation dimensions: D: 13 cm

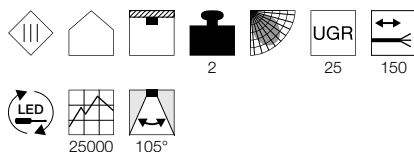

Dimensioned drawing

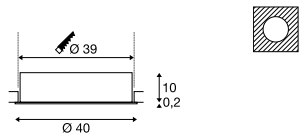

Note

Open cable end
Material thickness, mounting surface: 10-35 mm

Recommended accessories

- LED driver 700mA | 40W incl. strain relief
Item no. 464168
- LED driver 40W | 700mA | 1-10V/DALI dimmable, incl. strain relief
Item no. 1002424

Variant	Item no.
3100/3300lm 3000/4000K CRI>80	
□ white	1001906

MEDO 60
EL, installation frame



A-A++ Range A++-E



- Colour temperature (3000K/4000K) selectable using a switch

Product details

1000mA/1050mA | 28W
Material: Aluminium / Polymethylacrylate (PMMA)
Installation dimensions: D: 16 cm

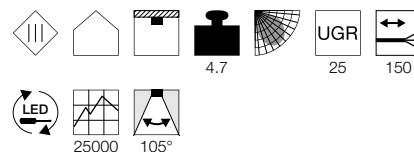

Dimensioned drawing

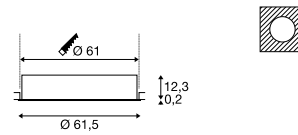

Note

Open cable end
Material thickness, mounting surface: 10-35 mm

Recommended accessories

- LED driver 60W | 1000mA | incl. strain relief
Item no. 1002422
- LED driver 50W | 1050mA | 1-10V/DALI dimmable, incl. strain relief
Item no. 1002425
- LED driver 1000mA | 40W | TRIAC dimmable, incl. strain relief
Item no. 1001115

Variant	Item no.
4700/5000lm 3000/4000K CRI>80	
□ white	1001907



MEDO 90
EL, installation frame



A-A++ Range A++-E

LED INSIDE

NEW VARIANT



- Colour temperature (3000K/4000K) selectable using a switch



Product details

1000mA/1050mA | 36W
Material: Aluminium / Polymethylacrylate (PMMA)
Installation dimensions: D: 21 cm

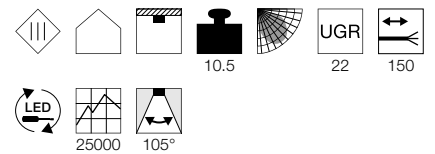

Dimensioned drawing

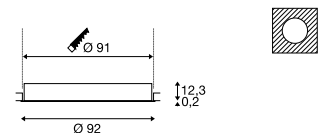

Note

Open cable end
Material thickness, mounting surface: 10-35 mm



Recommended accessories

- LED driver 60W | 1000mA | incl. strain relief
Item no. 1002422
- LED driver 50W | 1050mA | 1-10V/DALI dimmable, incl. strain relief
Item no. 1002425
- LED driver 1000mA | 40W | TRIAC dimmable, incl. strain relief
Item no. 1001115



Variant	Item no.
9550/10150lm 3000/4000K CRI>80	
<input type="checkbox"/> white	1001908

PANEL 60

EL, round

A-A++ Range A++-E

LED INSIDE



135150 522

- LED driver can be selected

Product details

1000mA/1050mA | 40W
Material: Aluminium

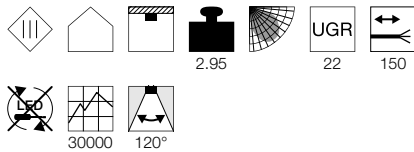

Dimensioned drawing

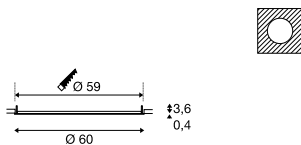

Note

1) Standard, non dimmable 40W/ 1000mA (464170).
2) DALI dimmable 50W/1050mA (464032).
3) TRIAC dimmable 40W/1050mA (464804).
In our Smart Home Solutions chapter, you will find different VALETO® accessories to suit your choice of transformer.
Open cable end
Material thickness, mounting surface: 30 mm max.

Recommended accessories

■ LED driver 1000mA |
40W incl. strain relief

Item no. **464170**

□ LED driver 350-1050mA |
50W | Dali 1-10V dimmable

Item no. **464032**

□ LED driver 1050mA |
40W Triac trailing edge dimmable

Item no. **464804**

Variant	Item no.
2630lm 3000K CRI>80 □ white	158663
2930lm 4000K CRI>80 □ white	158664

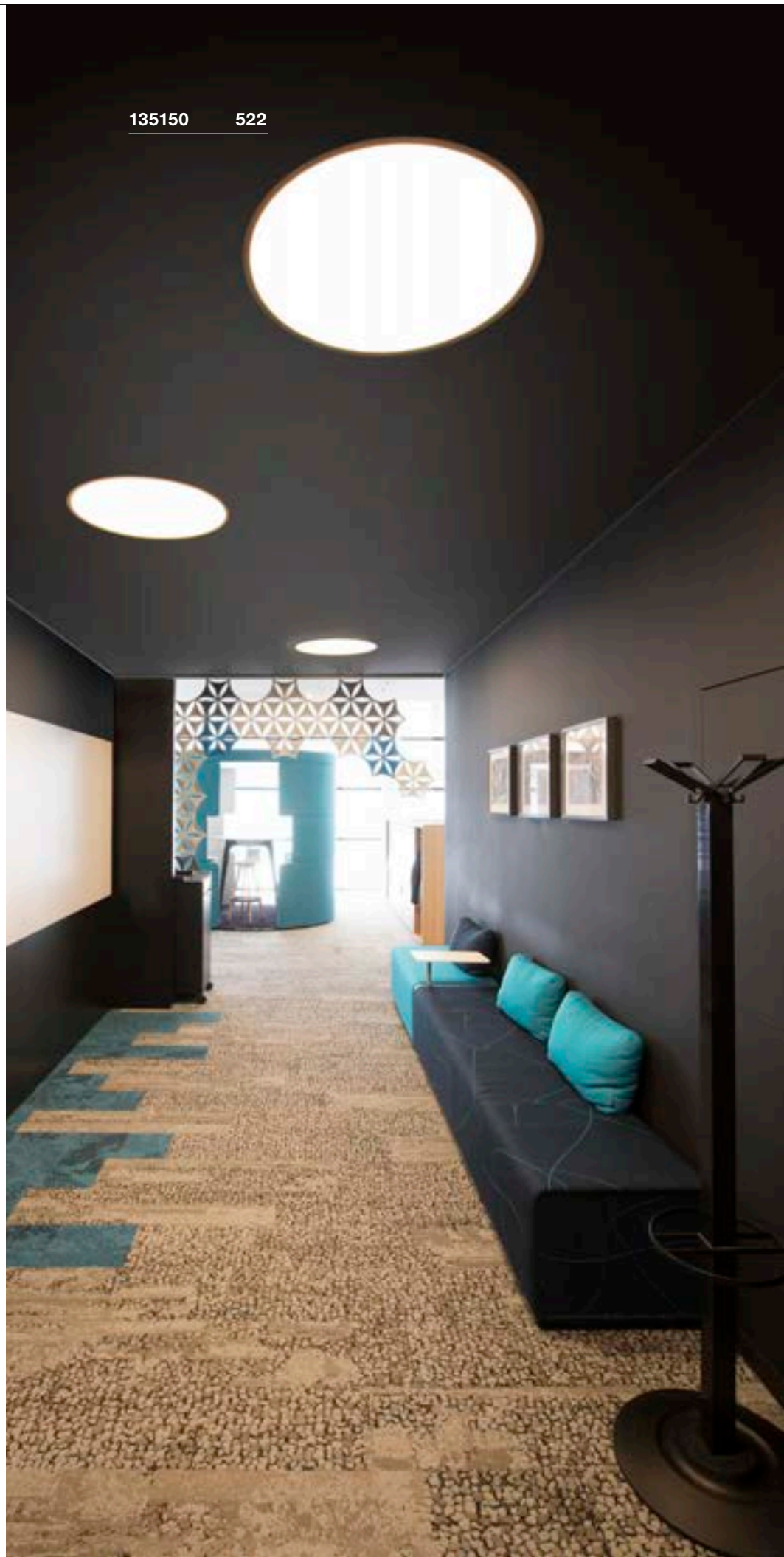



1001250 523



1001251 523

VALETO® LED PANEL
595x595mm, UGR<19

A-A++ Range A++-E



• Can be integrated into the VALETO® system

Product details

100-240V ~50/60Hz | 1050mA
Total consumption: 43W
Material: Aluminium / Acrylic

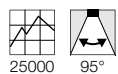

Dimensioned drawing

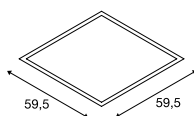

Note

Can be remotely controlled and dimmed using the remote control CCT/DIM [1002994] or gateway [1002411]

An application video about Dim to Warm can be found at <http://bit.ly/dim-to-warm>



Variant	Item no.
3200-3600lm 2700-6500K CRI>80 □ white	1001250

VALETO® LED PANEL
620x620mm, UGR<19

A-A++ Range A++-E



• Can be integrated into the VALETO® system

Product details

100-240V ~50/60Hz | 1050mA
Total consumption: 43W
Material: Aluminium / Acrylic

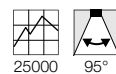
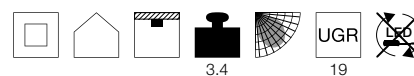

Dimensioned drawing

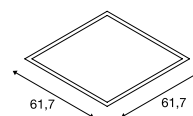

Note

Can be remotely controlled and dimmed using the remote control CCT/DIM [1002994] or gateway [1002411]

An application video about Dim to Warm can be found at <http://bit.ly/dim-to-warm>



Variant	Item no.
3200-3600lm 2700-6500K CRI>80 □ white	1001251

LED PANEL
600x600mm

A-A++ Range A++-E

LED INSIDE

NEW VARIANT

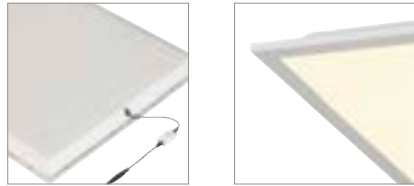

- Colour temperature selectable

Product details

700mA | 26W
Material: Aluminium / Polystyrene (PS)
Product dimensions: H: 3 cm
Installation dimensions: D: 5 cm

1.72 22 50

40000 120°

Dimensioned drawing

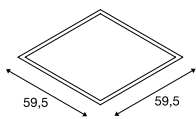

Note

Open cable end

Recommended accessories

LED driver 40W | 700mA | 1-10V/DALI dimmable, incl. strain relief
Item no. **1002424**



Variant	Item no.
2600/2800lm 3000/4000K CRI>80 <input type="checkbox"/> white	1003071

LED PANEL
620x620mm

A-A++ Range A++-E

LED INSIDE

NEW VARIANT



- Colour temperature selectable

Product details

700mA | 26W
Material: Aluminium / Polystyrene (PS)
Product dimensions: H: 3 cm
Installation dimensions: D: 5 cm

1.98 22 50

40000 120°

Dimensioned drawing

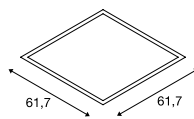

Note

Open cable end

Recommended accessories

LED driver 40W | 700mA | 1-10V/DALI dimmable, incl. strain relief
Item no. **1002424**



Variant	Item no.
2600/2800lm 3000/4000K CRI>80 <input type="checkbox"/> white	1003072

LED PANEL
620x620mm

A-A++ Range A++-E

LED INSIDE

NEW VARIANT



- Premium LED with CRI>90
- Suitable for screen workplaces in accordance with EN 12464-1
- UGR<19

Product details

1050mA | 35W
Material: Aluminium / Polystyrene (PS)
Product dimensions: H: 0,9 cm
Installation dimensions: D: 5 cm

2.55 19 150

50000 120°

Dimensioned drawing

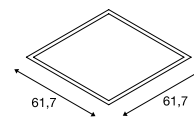

Note

Open cable end

Recommended accessories

LED driver 1050mA | 40W Triac trailing edge dimmable
Item no. **464804**
 LED driver 50W | 1050mA | 1-10V/DALI dimmable, incl. strain relief
Item no. **1002425**



Variant	Item no.
4000lm 4000K CRI>90 <input type="checkbox"/> white	1003074

LED PANEL
620x620mm

A-A++ Range A++-E



- Premium LED with CRI>90
- Suitable for screen workplaces in accordance with EN 12464-1
- UGR<19

Product details

1050mA | 35W
Material: Aluminium / Polystyrene (PS)
Product dimensions: H: 0,9
Installation dimensions: D: 5 cm

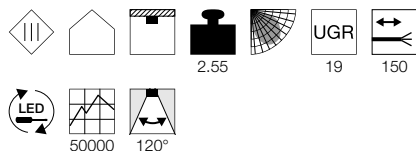

Dimensioned drawing

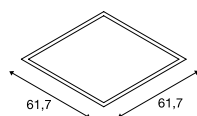

Note

Open cable end

Recommended accessories

- LED driver 1050mA | 40W Triac trailing edge dimmable
Item no. 464804
- LED driver 50W | 1050mA | 1-10V/DALI dimmable, incl. strain relief
Item no. 1002425

Variant	Item no.
4000lm 3000K CRI>90 <input type="checkbox"/> white	1003073

LED PANEL
600x600mm

A-A++ Range A++-E



- Premium LED with CRI>90
- Suitable for screen workplaces in accordance with EN 12464-1
- UGR<19

Product details

1050mA | 35W
Material: Aluminium / Polystyrene (PS)
Product dimensions: H: 0.9 cm
Installation dimensions: D: 5 cm

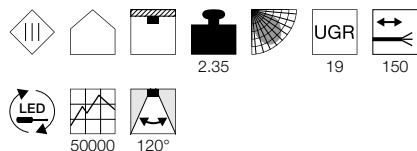

Dimensioned drawing

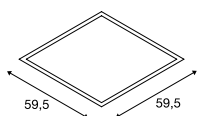

Note

Open cable end

Recommended accessories

- LED driver 1050mA | 40W Triac trailing edge dimmable
Item no. 464804
- LED driver 50W | 1050mA | 1-10V/DALI dimmable, incl. strain relief
Item no. 1002425

Variant	Item no.
4000lm 3000K CRI>90 <input type="checkbox"/> white	1003083
4000lm 4000K CRI>90 <input type="checkbox"/> white	1003084

LED PANEL
300x120mm

A-A++ Range A++-E



- Premium LED with CRI>90
- Suitable for screen workplaces in accordance with EN 12464-1
- UGR<19

Product details

900mA | 31W
Material: Aluminium / Polystyrene (PS)
Product dimensions:
L: 119.5 cm W: 29.5 cm H: 0.9 cm
Installation dimensions: D: 5 cm

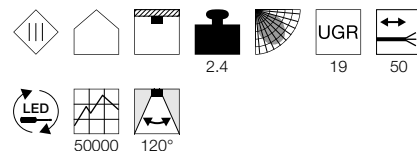

Dimensioned drawing

Note

Open cable end

Recommended accessories

- LED driver 50W | 1050mA | 1-10V/DALI dimmable, incl. strain relief
Item no. 1002425

Variant	Item no.
3600lm 3000/4000K CRI>90 <input type="checkbox"/> white	1003075

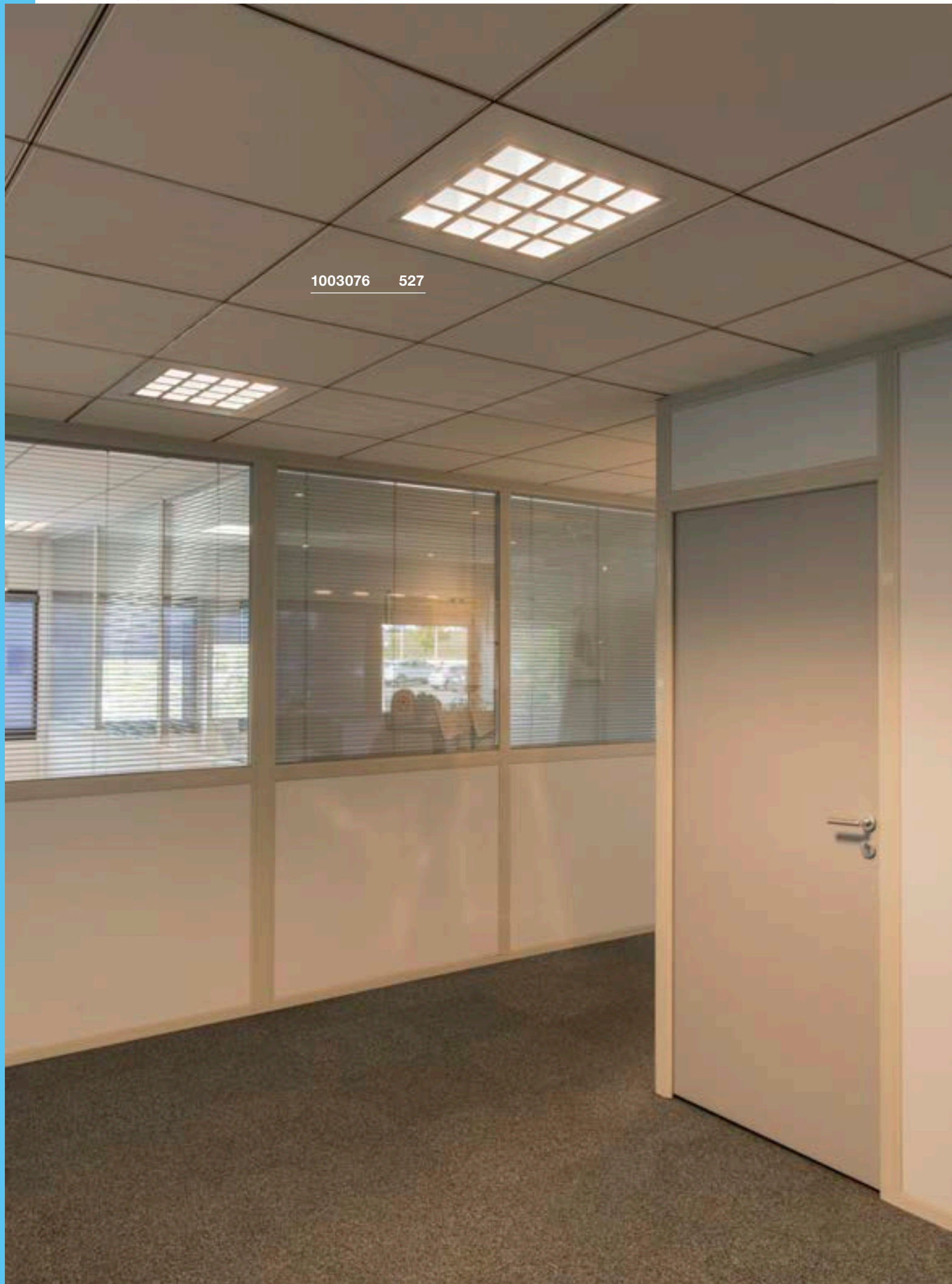

1003076 527

PAVANO
300x1200mm

A-A++ Range A++-E

LED INSIDE

NEW



- Premium LED with CRI>90
- Suitable for screen workplaces in accordance with EN 12464-1
- UGR<19

Product details

700mA | 25W
Material: Steel / Polycarbonate (PC)
Product dimensions:
L: 119.5 cm W: 29.5 cm H: 3.6 cm
Installation dimensions: D: 5 cm

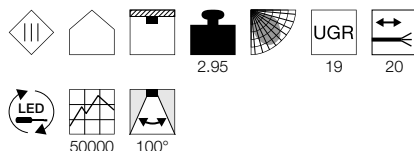

Note

Open cable end

Recommended accessories

LED driver 40W | 700mA | 1-10V/DALI dimmable, incl. strain relief
Item no. 1002424

Variant	Item no.
3300lm 3000K CRI>90 <input type="checkbox"/> white	1003080
3550lm 4000K CRI>90 <input type="checkbox"/> white	1003081

PAVANO
600x600mm

A-A++ Range A++-E

LED INSIDE

NEW



- Premium LED with CRI>90
- Suitable for screen workplaces in accordance with EN 12464-1
- UGR<19

Product details

700mA | 25W
Material: Steel / Polycarbonate (PC)
Product dimensions:
L: 59.5 cm W: 59.5 cm H: 3.6 cm
Installation dimensions: D: 5 cm

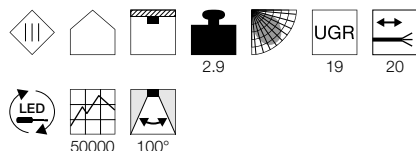

Note

Open cable end

Recommended accessories

LED driver 40W | 700mA | 1-10V/DALI dimmable, incl. strain relief
Item no. 1002424

Variant	Item no.
3300lm 3000K CRI>90 <input type="checkbox"/> white	1003076
3550lm 4000K CRI>90 <input type="checkbox"/> white	1003077

PAVANO
620x620mm

A-A++ Range A++-E

LED INSIDE

NEW



- Premium LED with CRI>90
- Suitable for screen workplaces in accordance with EN 12464-1
- UGR<19

Product details

700mA | 25W
Material: Steel / Polycarbonate (PC)
Product dimensions:
L: 62 cm W: 62 cm H: 3.6 cm
Installation dimensions: D: 5 cm

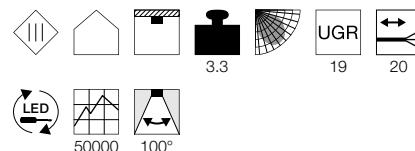

Note

Open cable end

Recommended accessories

LED driver 40W | 700mA | 1-10V/DALI dimmable, incl. strain relief
Item no. 1002424

Variant	Item no.
3300lm 3000K CRI>90 <input type="checkbox"/> white	1003078
3550lm 4000K CRI>90 <input type="checkbox"/> white	1003079

SHOWING THE WAY.

MOBILE LUMINAIRES AND FLOOR STANDS.

Nobody has to flounder in the dark any more: Mobile luminaires and floor stands are a popular design element for outdoor systems, and provide orientation and safety. The special appearance of the outdoor luminaires is due to their high-quality materials, modern designs and innovative technologies.

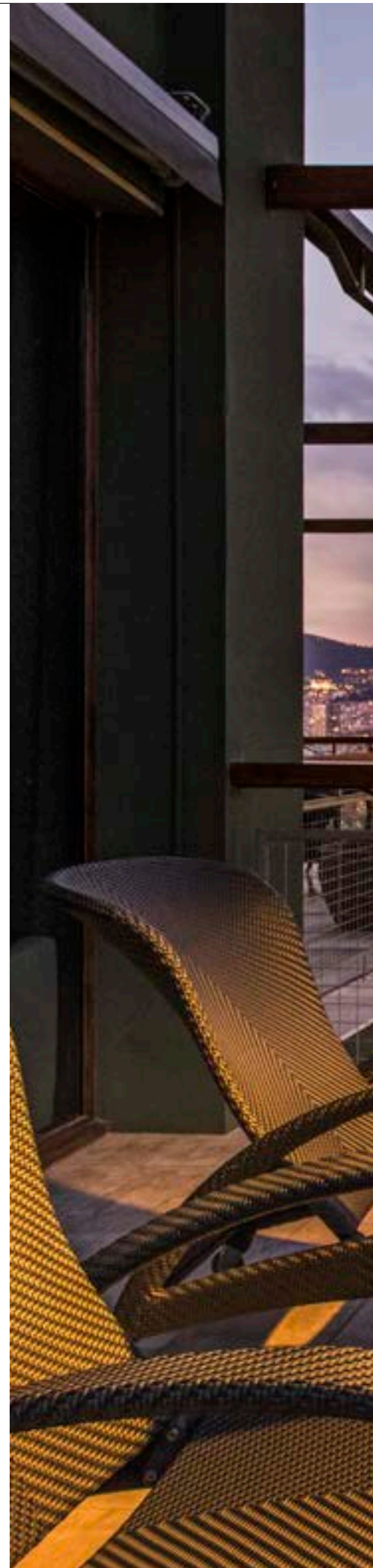

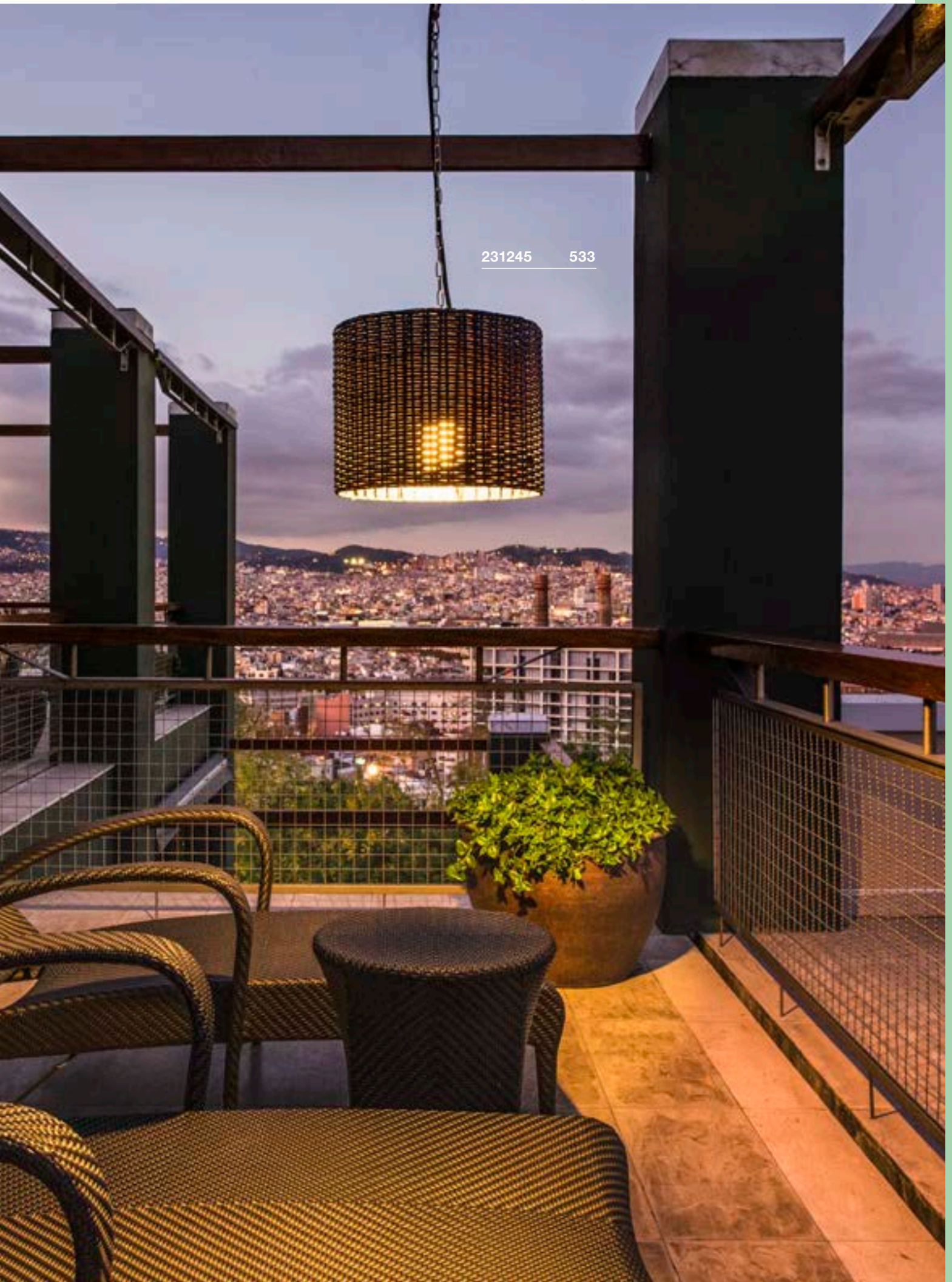

231245

533



1000822 550



MOBILE LUMINAIRES AND FLOOR STANDS



Other luminaires and variants can be found online at www.slv.com

PHOTONIA
PD, E27



E-A++ Range A++-E



MOLAT
PD, E27



E-A++ Range A++-E



Product details

220-240V ~50/60Hz
Material: Aluminium / Glass



Dimensioned drawing

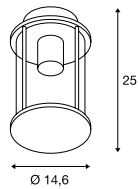

Note

Suspension chain included

Recommended accessories

■ Ceiling plate
Item no. **1000398**

Recommended lamp

LED E27 7.1W 330°
2700K 806lm EEL=A+
8kWh/1000h
Item no. **1001756**

LED E27 4.5W 280°
2200-2700K 500lm EEL=A++
5kWh/1000h
Item no. **1002125**

Lamp details

max. 60W
Ø: 9 cm max. L: 15 cm max.

Variant	Item no.
E27	
■ anthracite	232065

Product details

230V ~50/60Hz
Material: Aluminium / Glass



Dimensioned drawing

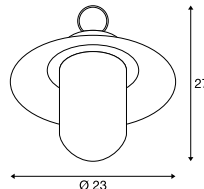

Note

Suspension chain included

Recommended accessories

■ Ceiling plate
Item no. **1000398**

Recommended lamp

E27 7.1W 330°
2700K 806lm EEL=A+
8kWh/1000h
Item no. **560741**

LED E27 4.5W 280°
2200-2700K 500lm EEL=A++
5kWh/1000h
Item no. **1002125**

Lamp details

max. 60W
Ø: 6.5 cm max. L: 14.5 cm max.

Variant	Item no.
E27	
■ anthracite	1000821

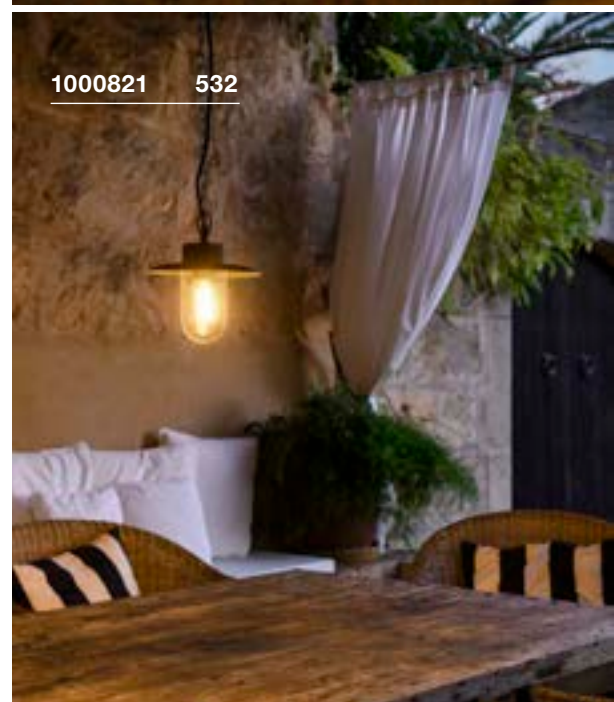



231245 533

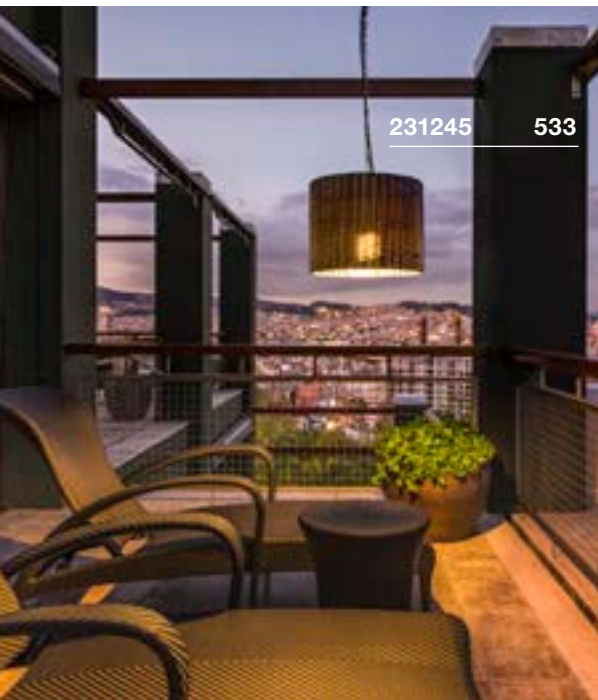

231245 533



228050 533

ADEGAN MANILA PD, E27



A-A++ Range A++-E



- Weather-resistant braiding

Product details

230V ~50Hz
Material: Steel / Polyethylene (PE)



Dimensioned drawing

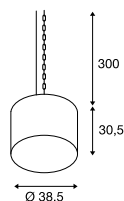

Note

Suspension chain and hook included
IP 2-pin mains plug

Recommended lamp

E27 9W 240°
3000K 810lm EEL=A+
10kWh/1000h
Item no. 1001031



LED E27 12W 240°
3000K 1055lm EEL=A+
12kWh/1000h
Item no. 1001032



Lamp details

max. 24W
Ø: 4.8 cm max. L: 14 cm max.

Variant	Item no.
E27	
■ anthracite	231245

ROTOBALL 25/40 PD, E27



A-A++ Range A++-E

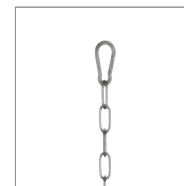

- Harmonious design
- Homogeneous light distribution
- For decorative lighting and aesthetic accentuation in indoor and outdoor areas

Product details

230V ~50/60Hz
Material: Aluminium / Plastic

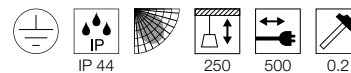

Dimensioned drawing

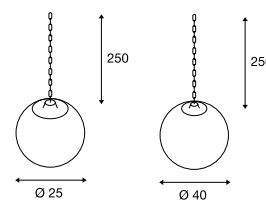

Note

Suspension chain and hook included
IP 2-pin mains plug

Recommended lamp

LED E27 14.5W 200°
2700K 1521lm EEL=A+
15kWh/1000h
Item no. 560422



LED E27 9.5W 240°
2200-6700K 806lm EEL=A+
10kWh/1000h
Item no. 1001917



Lamp details

max. 24W

Variant	Item no.
E27 Ø: 25 cm 1.25 kg	
■ grey / white	228050
E27 Ø: 40 cm 2.3 kg	
■ grey / white	228051

KIROCONE TL, E27

E-A++ Range
A++-E

NEW



Product details

230V ~50Hz
Material: Steel / Polycarbonate (PC)



Dimensioned drawing

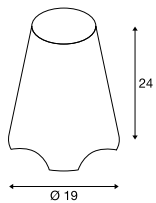

Note

IP 2-pin mains plug

Recommended lamp

LED E27 9W 240°
2700-6500K 806lm EEL=A+
9kWh/1000h

Item no. 560402



LED E27 9.5W 240°
2200-6700K 806lm EEL=A+
10kWh/1000h

Item no. 1001917



Lamp details

max. 60W
Ø: 9.5 cm max. L: 14.5 cm max.

Variant	Item no.
E27 □ white	1001778



1001778 534



1001778 534



227550 537



1000400 537



1000400 537

KENGA 17 TL



- Mobile, wireless luminaire with removable menu holder
- Infinitely variable dimming using the button
- Convenient charging via USB

Product details

5V DC battery operation
 Total consumption: 3.2W
 Material: Plastic / Wood
 Dimmable: Switch

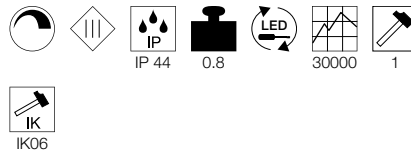

Dimensioned drawing

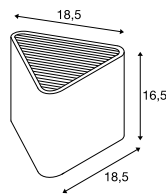

Note

The operating time is 5 hours at full brightness and 10 hours at half brightness.
 The product can be charged using any 5V USB power supply.
 The bracket can be adjusted in order to hold menus or serviettes.

Variant	Item no.
200lm 3000K CRI>80	
■ matt white / matt brown	1000400

KENGA 45 FL, E27



- Mobile luminaire
- Luminaire and seat in one

Product details

230V ~50/60Hz
 Material: Polyethylene (PE) / Steel

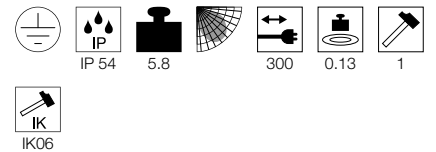

Dimensioned drawing

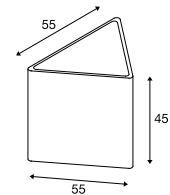

Note

IP 2-pin mains plug

Recommended lamp

E27 15W 240°
 3000K 1521lm EEL=A+
 15kWh/1000h
Item no. 1001033

LED E27 7W 280°
 2700K 790lm EEL=A++
 7kWh/1000h
Item no. 1002127



Lamp details

max. 24W
 L: 22 cm max.

Variant	Item no.
E27	
□ white	227550

ROTOBALL 25/40/50
FL, E27  895

A-A++  Range
A++-E



- Harmonious design
- Homogeneous light distribution
- For decorative lighting and aesthetic accentuation in indoor and outdoor areas

Product details

230V ~50Hz
Material: Steel / Polyethylene (PE)



Dimensioned drawing

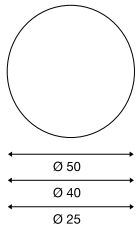

Note

IP 2-pin mains plug

Recommended lamp

LED E27 14.5W 200°
2700K 1521lm EEL=A+
15kWh/1000h
Item no. 560422



LED E27 9W 240°
2700-6500K 806lm EEL=A+
9kWh/1000h
Item no. 1001916



Lamp details

max. 24W
Ø: 9.5 cm max.

Variant	Item no.
E27 Ø: 25 cm 1.05 kg □ white	227219
E27 Ø: 40 cm 2.2 kg □ white	227220
E27 Ø: 50 cm 3.12 kg □ white	227221



227221 538



227221 538

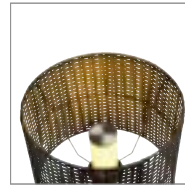

231395 539

ADEGAN MANILA
FL, E27A-A++ Range
A++-EFOLLOW
UP

Product details

230V ~50Hz
Material: Granite / Stainless Steel

Dimensioned drawing

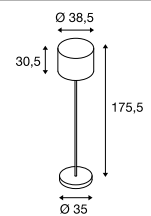

Note

IP 2-pin mains plug

Lamp details

max. 15W
 \varnothing : 4.8 cm max. L: 18 cm max.

Variant	Item no.
E27	
■ stainless steel / anthracite	1002494

ADEGAN
FL, E27

A-A++ Range A++-E



- Mobile luminaire
- Lamp shade: extremely UV-resistant polycarbonate
- Feel-good light for every style

Product details

220-240V ~50/60Hz
Material: Aluminium / Polycarbonate (PC)

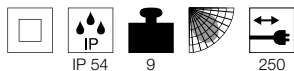

Dimensioned drawing

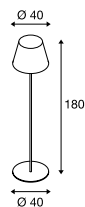

Note

IP 2-pin contour plug

Recommended accessories

Earth spike
Item no. 228960



Recommended lamp

E27 15W 240°
3000K 1521lm EEL=A+
15kWh/1000h
Item no. 1001033



Lamp details

max. 24W
Ø: 5.2 cm max.

Variant	Item no.
E27 white	228961
E27 anthracite / white	228965

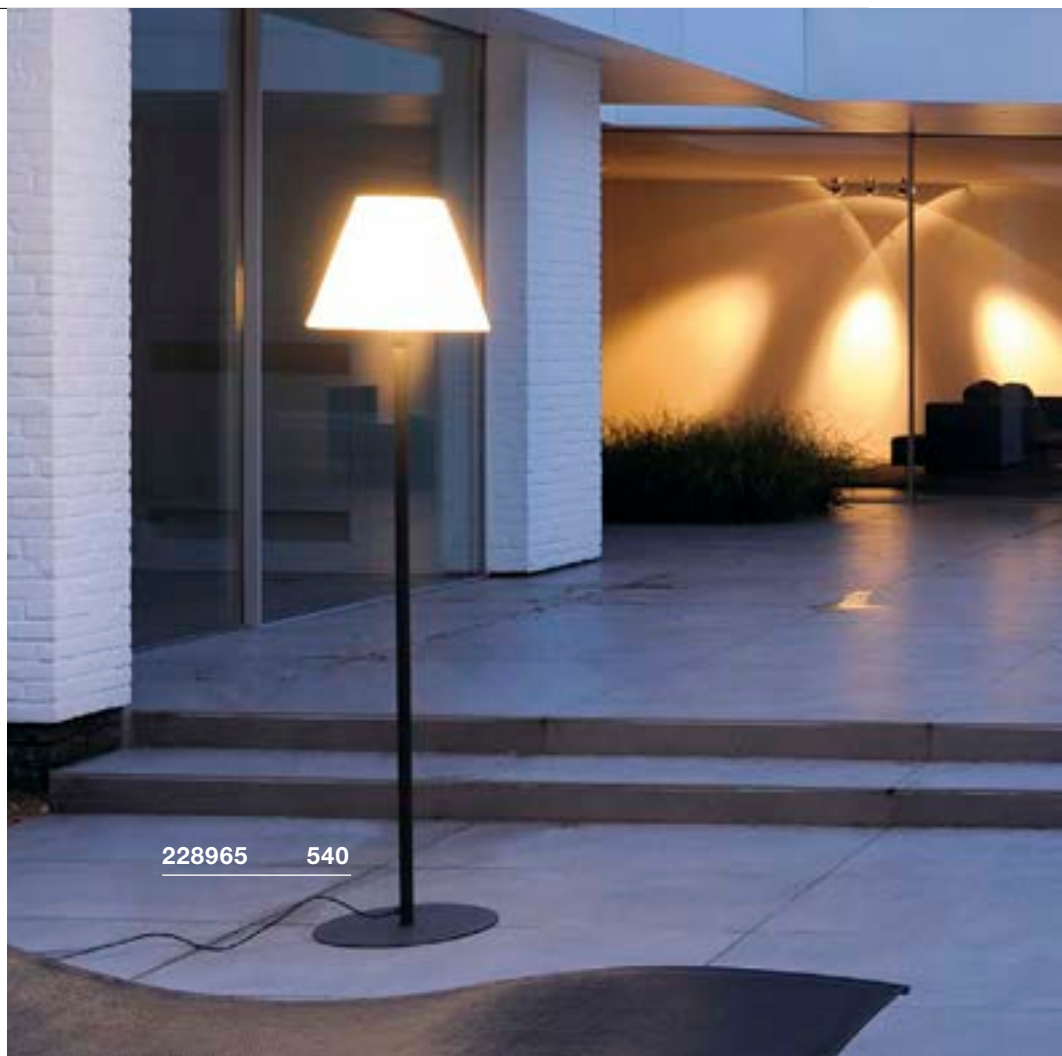

228965 540



228961 540



232095 541



231360 541

PHOTONIA
TL, E27

893

E-A++ Range A++-E



- Extra-long connecting cable with IP 2-pin mains plug

Product details

220-240V ~50/60Hz
Material: Aluminium / Glass



Dimensioned drawing

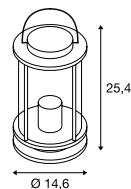

Note

IP 2-pin mains plug

Recommended lamp

E27 5W 330°
2000K 500lm EEL=A+
5kWh/1000h
Item no. 560741



LED E27 4.5W 280°
2700K 530lm EEL=A++
5kWh/1000h
Item no. 1002123



Lamp details

max. 60W
Ø: 9 cm max. L: 15 cm max.

Variant	Item no.
■ anthracite	232095

LISENNE
TL, E27

890

E-A++ Range A++-E



- Basalt and smoked glass
- Switch on underside of luminaire

Product details

230V ~50/60Hz
Material: Basalt / Glass

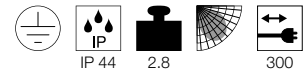

Dimensioned drawing

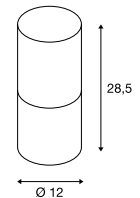

Note

IP 2-pin mains plug

Recommended lamp

LED E27 7.1W 330°
2700K 806lm EEL=A+
8kWh/1000h
Item no. 1001756



Lamp details

max. 23W
Ø: 5.9 cm max. L: 15 cm max.

Variant	Item no.
■ grey / brown	231360

CUBIX
FL, QPAR51

E-A++ Range
A++-E

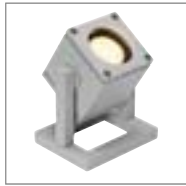

• Mobile luminaire

Product details

230V ~50Hz
Material: Aluminium / Glass



Dimensioned drawing

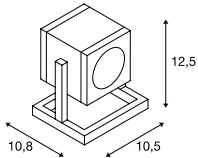

Note

IP 2-pin mains plug

Recommended lamp

LED GU10 5.5W 38°
2700K 400lm EEL=A+
6kWh/1000h
Item no. 1001030



Lamp details

max. 25W QPAR51

Variant	Item no.
GU10 QPAR51	
 grey	132832
GU10 QPAR51	
 anthracite	132835



132832 542

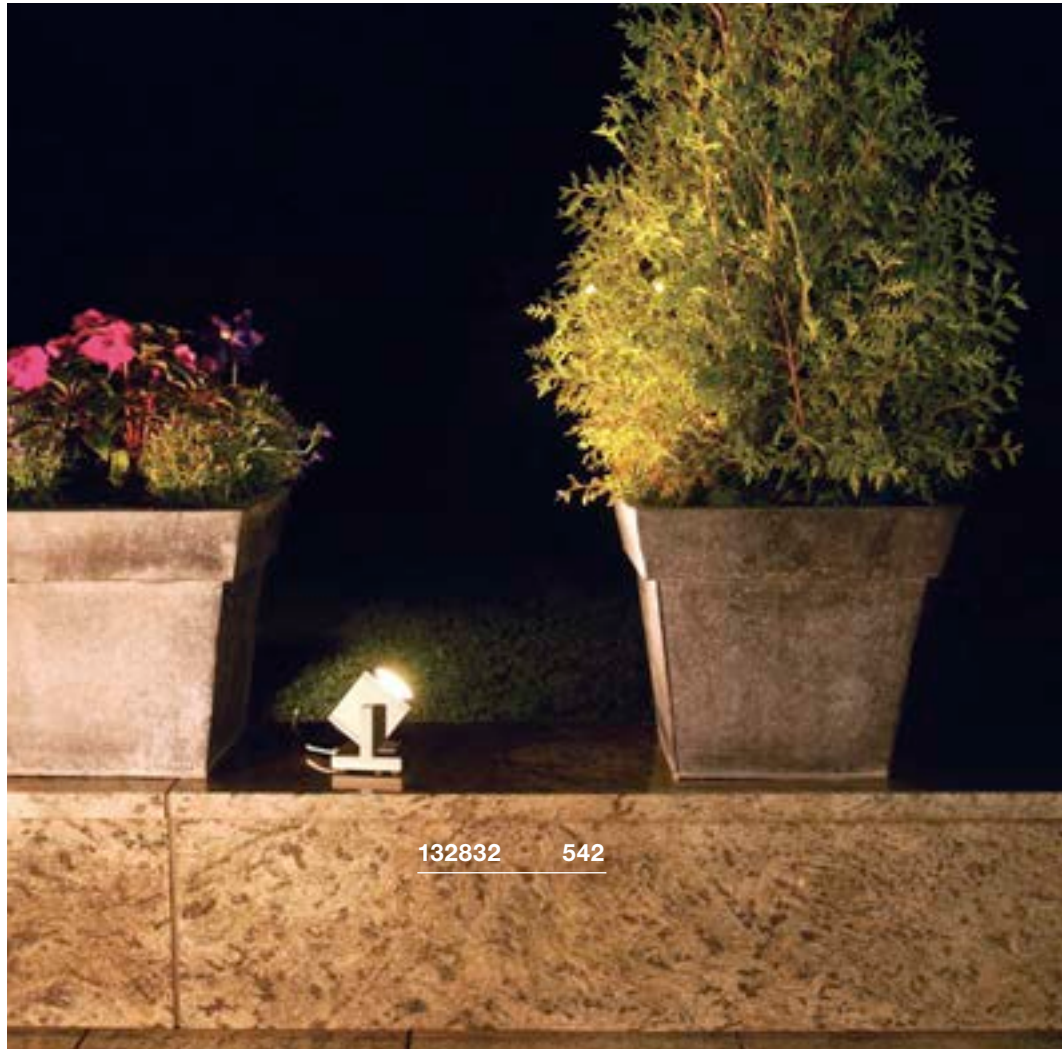

132832 542



230435 543

CONE FL, E27

E-A++ Range
A++-E



Product details

220-240V ~50/60Hz
Material: Aluminium / Glass



IP 54



2.55

Dimensioned drawing

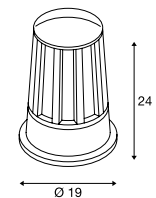

Note

Material thickness, mounting surface: 20 mm

Recommended lamp

LED E27 14.5W 200°
2700K 1521lm EEL=A+
15kWh/1000h

Item no. 560422



LED E27 7W 280°
2700K 790lm EEL=A++
7kWh/1000h

Item no. 1002124



Lamp details

max. 100W
L: 15 cm max.

Variant	Item no.
E27 ■ anthracite	230435

RUSTY® CONE
FL, E14

A-A++ Range A+-E



- Rusty steel
- Each fitting is unqu
- Small walkway light for entrance and garden

Product details

230V ~50Hz
Material: FeCSI-Steel / Polycarbonate (PC)

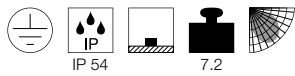

Dimensioned drawing

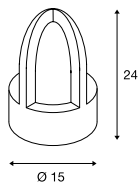

Recommended lamp

E14 3.4W 260°
3000K 250lm EEL=A+
4kWh/1000h
Item no. 560362



LED E14 6.5W 280°
3000K 480lm EEL=A+
7kWh/1000h
Item no. 560372



Lamp details

max. 40W C35
Ø: 4.8 cm max. L: 13.9 cm max.

Variant	Item no.
E14 C35	
rust	229430

RUSTY® CONE 40/70
Pole, E27

A-A++ Range A+-E



- Rusty steel
- Each fitting is unqu

Product details

230V ~50Hz
Material: FeCSI-Steel / Polycarbonate (PC)

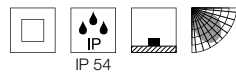

Dimensioned drawing

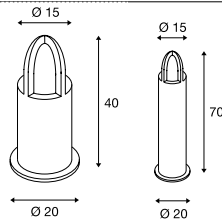

Recommended accessories

■ IP68 connection box, 3-pole

Item no. 228730



■ Earth spike

Item no. 229423



Recommended lamp

E27 9W 240°
3000K 810lm EEL=A+
10kWh/1000h
Item no. 1001031



Lamp details

max. 11W
Ø: 4.8 cm max. L: 13.9 cm max.

Variant	Item no.
E27 H: 40 cm 12.2 kg	
rust	229431
E27 H: 70 cm 18.8 kg	
rust	229432

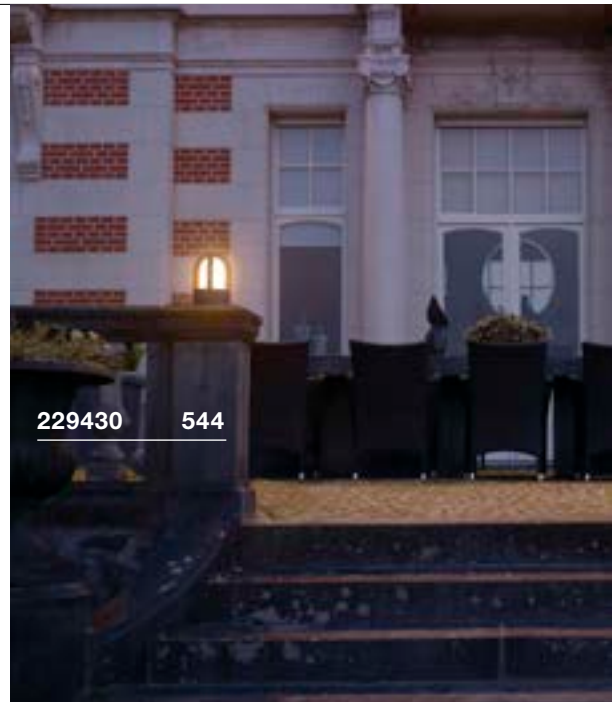

229430 544

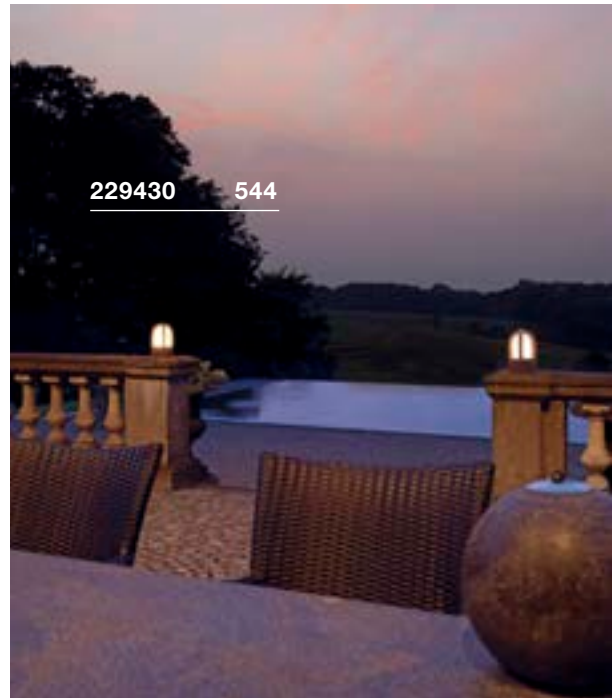

229430 544



229431 544



229021 545



229020 545

RUSTY® 40/70
Pole, E27

A-A++ Range A++-E



- Rusty steel
- Each fitting is unique

Product details

230V ~50Hz
Material: FeCSi-Steel / Polycarbonate (PC)

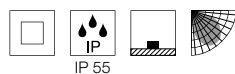

Dimensioned drawing

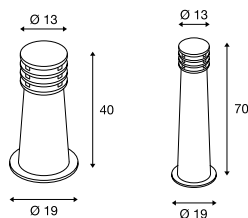

Recommended accessories

- IP68 connection box, 3-pole
Item no. 228730
- Earth spike
Item no. 229022

Recommended lamp

- E27 4.7W 360°
3000K 380lm EEL=A+
5kWh/1000h
Item no. 551532
- LED E27 9W 240°
3000K 810lm EEL=A+
10kWh/1000h
Item no. 1001031

Lamp details

max. 11W
Ø: 4.8 cm max. L: 13.9 cm max.

Variant	Item no.
E27 H: 40 cm 11 kg ■ rust	229020
E27 H: 70 cm 17.5 kg ■ rust	229021

RUSTY® 40/70
Pole

A-A++ Range A++-E

LED INSIDE



- Rusty steel
- Each fitting is unique
- 240V LED

Product details

220-240V ~50/60Hz
Total consumption: 8.6W
Material: FeCSi-Steel / Polycarbonate (PC)

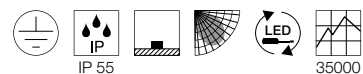

Dimensioned drawing

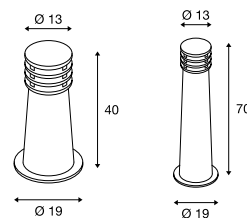

Note

Open cable end

Recommended accessories

- IP68 connection box, 3-pole
Item no. 228730
- Earth spike
Item no. 229022

Variant	Item no.
70lm 3000K CRI>80 H: 40 cm 11 kg ■ rust	233407
70lm 3000K CRI>80 H: 70 cm 17.5 kg ■ rust	233417

LISENNE 40/70
Pole, E27



E-A++ Range A++-E



• Basalt and smoked glass

Product details

230V ~50/60Hz
Material: Basalt / Glass

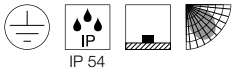

Dimensioned drawing

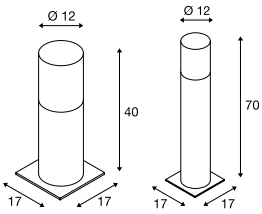

Recommended accessories

■ Earth spike
Item no. 229422



Recommended lamp

LED E27 7.1W 330°
2700K 806lm EEL=A+
8kWh/1000h
Item no. 1001756



Lamp details

max. 23W
Ø: 5.9 cm max. L: 15 cm max.

Variant	Item no.
E27 H: 40 cm 5.65 kg ■ grey / brown	1000665
E27 H: 70 cm 12.4 kg ■ grey / brown	1000666



1000665 546



232075 547



230465 547

PHOTONIA
Pole, E27



E-A++ Range A++-E



OTOS GLAS
Pole, E27

A-A++ Range A++-E



Product details

220-240V ~50/60Hz
Material: Aluminium / Glass



Dimensioned drawing

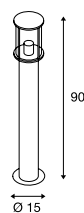

Note

Open cable end

Recommended accessories

- Concrete anchor
Item no. 232085
- IP68 connection box, 3-pole
Item no. 228730

Recommended lamp

E27 5W 330°
2000K 500lm EEI=A+
5kWh/1000h
Item no. 560741

Lamp details

max. 60W
Ø: 9 cm max. L: 15 cm max.

Variant	Item no.
E27	
■ anthracite	232075

Product details

230V ~50Hz
Material: Aluminium / Glass

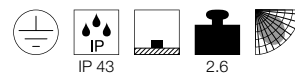

Dimensioned drawing

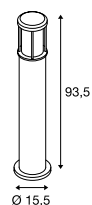

Recommended accessories

- Screw set
Item no. 228753
- IP68 connection box, 3-pole
Item no. 228730

Recommended lamp

LED E27 14.5W 200°
2700K 1521lm EEI=A+
15kWh/1000h
Item no. 560422

LED E27 6.8W 330°
2700K 806lm EEI=A++
7kWh/1000h
Item no. 560762

Lamp details

max. 15W
Ø: 6.5 cm max. L: 14.5 cm max.

Variant	Item no.
E27	
■ anthracite	230465

GLOO PURE 27/44/70
Pole, E27



E-A++ Range A++-E



Product details

230V ~50Hz
Material: Aluminium / Glass

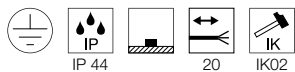

Dimensioned drawing

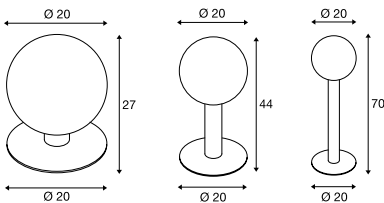

Note

Open cable end

Recommended accessories

■ IP68 connection box, 3-pole
Item no. 228730

■ Earth spike
Item no. 231234



Recommended lamp

E27 9W 240°
3000K 810lm EEL=A+
10kWh/1000h
Item no. 1001031



LED E27 15W 240°
3000K 1521lm EEL=A+
15kWh/1000h
Item no. 1001033



Lamp details

max. 23W
Ø: 4.8 cm max. L: 18 cm max.

Variant	Item no.
E27 H: 27 cm 1.5 kg	
■ anthracite/matt transparent	1001999
E27 H: 44 cm 1.7 kg	
■ anthracite/matt transparent	1002000
E27 H: 70 cm 1.9 kg	
■ anthracite/matt transparent	1002001

ALPA CONE 100
Pole, E27

A-A++ Range A++-E



Product details

220-240V ~50/60Hz
Material: Aluminium / Polycarbonate (PC)

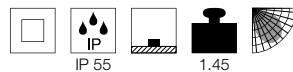

Dimensioned drawing

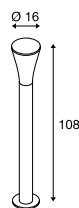

Note

Open cable end

Recommended accessories

■ IP68 connection box, 3-pole
Item no. 228730

■ Earth spike
Item no. 228722

Concrete anchor
Item no. 228712



Recommended lamp

E27 9W 240°
3000K 810lm EEL=A+
10kWh/1000h
Item no. 1001031



LED E27 12W 240°
3000K 1055lm EEL=A+
12kWh/1000h
Item no. 1001032



Lamp details

max. 24W
Ø: 5.2 cm max. L: 17.5 cm max.

Variant	Item no.
E27	
■ grey	228922
E27	
■ anthracite	228925



1001999 548



228925 548

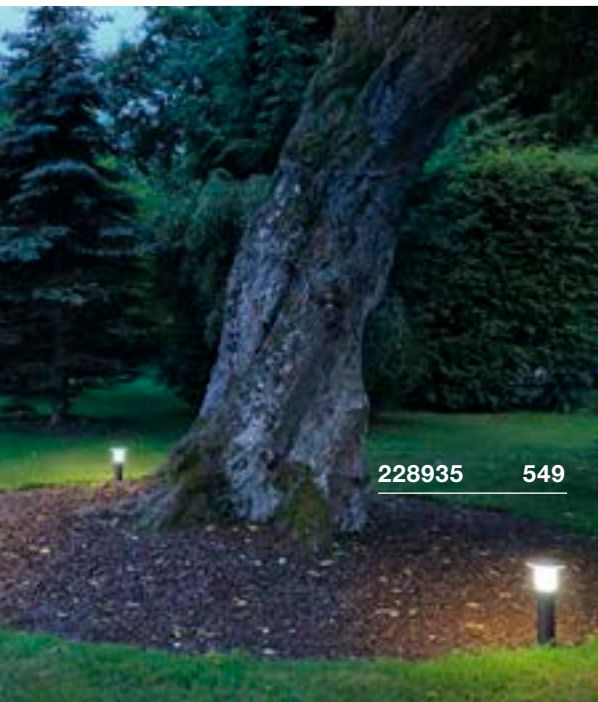

228935 549

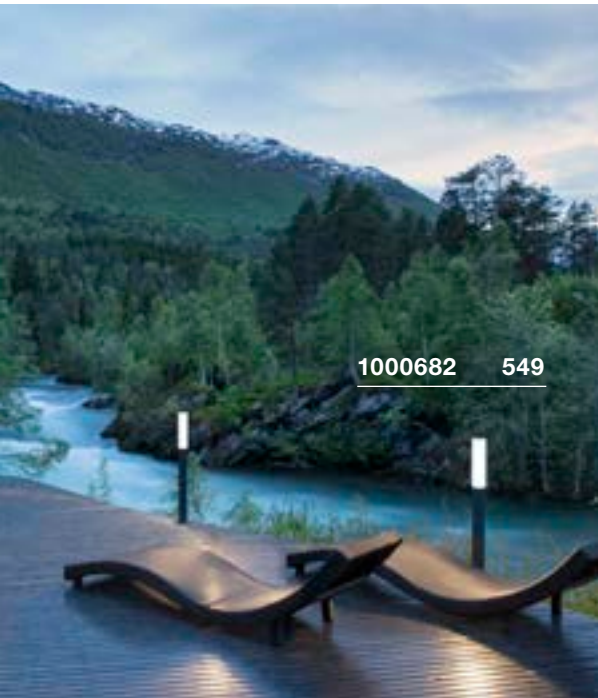

1000682 549

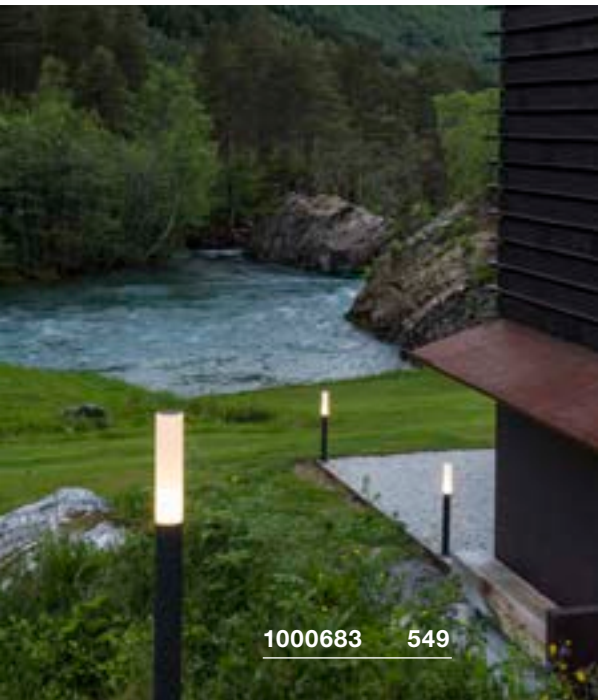

1000683 549

ALPA MUSHROOM 45/75 Pole, E27

A-A++ Range A++-E



Product details

220-240V ~50/60Hz
Material: Aluminium / Polycarbonate (PC)

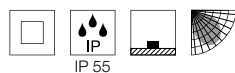

Dimensioned drawing

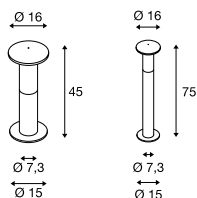

Note

Open cable end

Recommended accessories

■ IP68 connection box, 3-pole

Item no. 228730

■ Earth spike

Item no. 228722

■ Concrete anchor

Item no. 228712

Recommended lamp

E27 15W 240°
3000K 1521lm EEL=A+
15kWh/1000h

Item no. 1001033

Lamp details

max. 24W
Ø: 5.2 cm max. L: 16 cm max.

Variant	Item no.
E27 H: 45 cm 0.9 kg ■ anthracite	228935
E27 H: 75 cm 2 kg ■ anthracite	228945

APONI 90/120 Pole, TRIAC

A-A++ Range A++-E

LED INSIDE

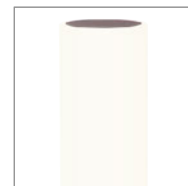

• 240V LED

Product details

220-240V ~50/60Hz
Total consumption: 8W
Material: Aluminium
Dimmable: Triac L

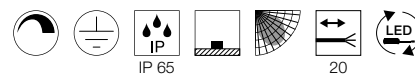

Dimensioned drawing

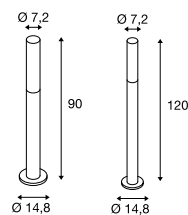

Note

Open cable end

Recommended accessories

■ IP68 connection box, 3-pole

Item no. 228730

Variant	Item no.
440lm 3000K CRI>80 H: 90 cm 1.466 kg ■ anthracite	1000682
440lm 3000K CRI>80 H: 120 cm 1.845 kg ■ anthracite	1000683

LIGHT PIPE 60/90/140
Pole, TRIAC



A-A++ Range A++-E

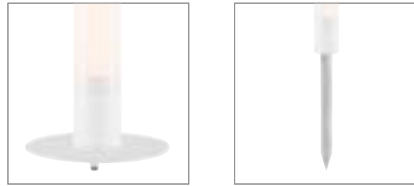
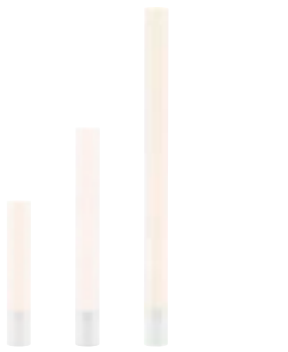

• Suitable for indoor and outdoor use

Product details

220-240V ~50/60Hz
Total consumption: 11W
Material: Aluminium / Polymethylacrylate (PMMA)
Dimmable: Triac C, Triac L

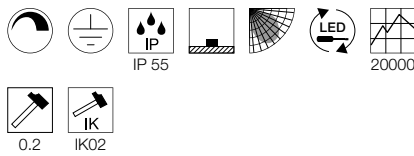

Dimensioned drawing

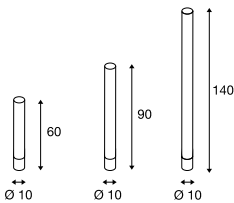

Note

Luminaire supplied without a mounting plate
Indoor installation plate with foot switch on the connection lead
Outdoor installation plate without foot switch, with IP44 shock-proof 2-pin plug

Recommended accessories

- Earth spike
Item no. 234430
- Outdoor installation plate
Item no. 234431
- Indoor installation plate
Item no. 234441

Variant	Item no.
630lm 2700K CRI>80 H: 60 cm 1.5 kg <input type="checkbox"/> white	234401
630lm 2700K CRI>80 H: 90 cm 1.71 kg <input type="checkbox"/> white	234411
630lm 2700K CRI>80 H: 140 cm 2.06 kg <input type="checkbox"/> white	234421

MOLAT
Pole, E27



E-A++ Range A++-E



Product details

230V ~50/60Hz
Material: Aluminium / Glass



Dimensioned drawing

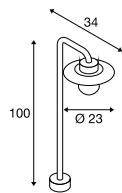

Recommended accessories

- Earth spike
Item no. 230060

Recommended lamp

E27 7.1W 330°
2700K 806lm EEL=A+
8kWh/1000h
Item no. 560741

LED E27 9W 240°
3000K 810lm EEL=A+
10kWh/1000h
Item no. 1001031

Lamp details

max. 60W
Ø: 6.5 cm max. L: 14.5 cm max.

Variant	Item no.
E27 <input checked="" type="checkbox"/> anthracite	1000822





228110 551



231602 551

TRUST 30/60 Pole



A-A++ Range A++-E

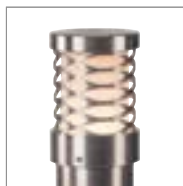

- Stainless steel 316
- 240V LED
- Sleek walkway lighting for wide range of outdoor arrangements

Product details

220-240V ~50/60Hz
 Total consumption: 8.6W
 Material: Stainless Steel 316

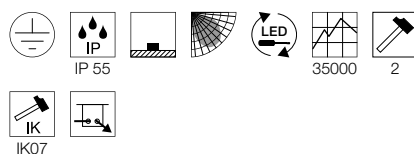

Dimensioned drawing

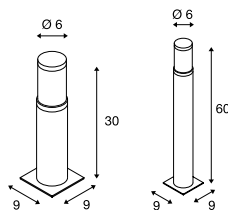

Recommended accessories

- IP68 connection box, 3-pole
Item no. 228730
- Earth spike
Item no. 227922
- Grid, helical
Item no. 1000449
- Grid, circular
Item no. 228130

Variant	Item no.
400lm 3000K CRI>80 H: 30 cm 1.4 kg	228100
400lm 3000K CRI>80 H: 60.5 cm 2.25 kg	228110

BIG NAILS PLUS 50/80 Pole, E27



A-A+ Range A++-E



- Stainless steel 304

Product details

230V ~50Hz
 Material: Stainless Steel 304 / Acrylic

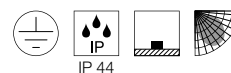

Dimensioned drawing

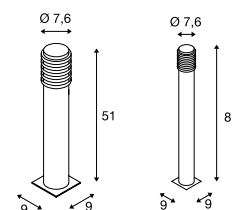

Recommended accessories

- IP68 connection box, 3-pole
Item no. 228730
- Earth spike
Item no. 227922

Recommended lamp

- E27 12W 240°
3000K 1055lm EEL=A+
12kWh/1000h
Item no. 1001032
- LED E27 15W 240°
3000K 1521lm EEL=A+
15kWh/1000h
Item no. 1001033

Lamp details

max. 23W
 Ø: 4.8 cm max. L: 14.8 cm max.

Variant	Item no.
E27 H: 50 cm 1.13 kg	231602
E27 H: 80 cm 1.54 kg	231612

BIG NAILS 50/80 Pole



A-A++ Range A++-E



Product details

230V ~50Hz
Total consumption: 8.5W
Material: Stainless Steel 316

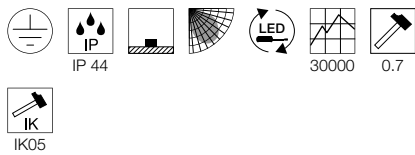

Dimensioned drawing

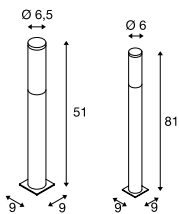

Recommended accessories

■ Earth spike
Item no. **227922**

Variant	Item no.
480lm 3000K CRI>80 H: 50 cm 0.9 kg ■ stainless steel	1001997
480lm 3000K CRI>80 H: 80 cm 1.235 kg ■ stainless steel	1001998

BIG NAILS 50/80 Pole, E27



A-A+ Range A++-E



Product details

230V ~50Hz
Material: Stainless Steel 304 / Polycarbonate (PC)

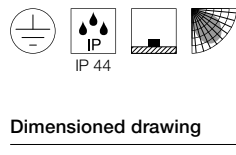

Dimensioned drawing

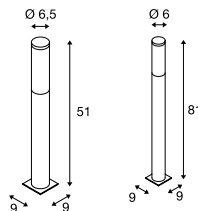

Recommended accessories

■ Earth spike
Item no. **227922**

Recommended lamp

E27 4.7W 360°
3000K 380lm EEL=A+
5kWh/1000h
Item no. **551532**

LED E27 9W 240°
3000K 810lm EEL=A+
10kWh/1000h
Item no. **1001031**

Lamp details

max. 15W
Ø: 4.5 cm max. L: 17 cm max.

Variant	Item no.
E27 H: 51 cm 1.1 kg ■ stainless steel	229162
E27 H: 81 cm 1.6 kg ■ stainless steel	229172



229162 552



229172 552



1001491 553



1001493 553

ROX ACRYL 30/60/90 Pole, TRIAC  895



Product details

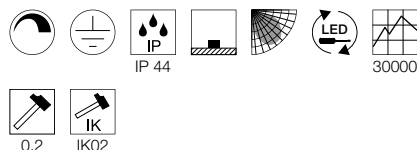

220-240V ~50/60Hz
 Total consumption: 12W
 Material: Stainless Steel 316
 Dimmable: Triac C, Triac L



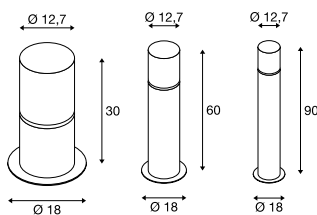



Dimensioned drawing



Recommended accessories

-  T-connector box
Item no. 228726
-  Concrete anchor
Item no. 1001494
-  Earth spike
Item no. 231234

Variant	Item no.
690lm 3000K CRI>80 H: 30 cm 1.55 kg  stainless steel	1001491
690lm 3000K CRI>80 H: 60 cm 2.55 kg  stainless steel	1001492
690lm 3000K CRI>80 H: 90 cm 3.45 kg  stainless steel	1001493

ROX ACRYL 30/60/90 Pole, E27  895



Product details

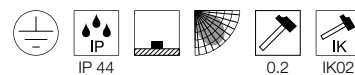

220-240V ~50/60Hz
 Material: Stainless Steel 304

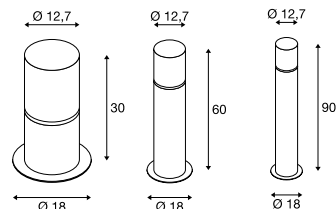

Dimensioned drawing



Recommended accessories

-  T-connector box
Item no. 228726
-  Concrete anchor
Item no. 1001494
-  Earth spike
Item no. 231234

Recommended lamp

- LED E27 9.1W 240°
2700K 760lm EEL=A+
10kWh/1000h
Item no. 560402 
- LED E27 14.5W 200°
2700K 1521lm EEL=A+
15kWh/1000h
Item no. 560422 

Lamp details

max. 20W
 Ø: 6 cm max. L: 15 cm max.

Variant	Item no.
E27 H: 30 cm 1.1 kg  stainless steel	1001488
E27 H: 60 cm 2.1 kg  stainless steel	1001489
E27 H: 90 cm 3 kg  stainless steel	1001490

VAP SLIM 30/60/90
Pole, E27



- Stainless steel 304
- Sleek walkway light for wide range of outdoor arrangements

Product details

230V ~50Hz
Material: Stainless steel 304



Dimensioned drawing

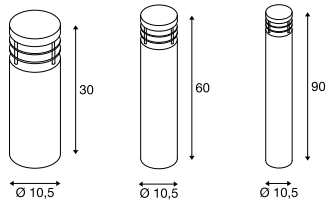

Recommended accessories

- Earth spike
Item no. 230060
- Concrete anchor
Item no. 230061

Recommended lamp

E27 9W 240°
3000K 810lm EEL=A+
10kWh/1000h
Item no. 1001031

Lamp details

max. 20W
Ø: 5 cm max. L: 12.6 cm max.

Variant	Item no.
E27 H: 30 cm 1.5 kg ■ matt stainless steel	230063
E27 H: 60 cm 2.5 kg ■ matt stainless steel	230066
E27 H: 90 cm 3.4 kg ■ matt stainless steel	230069

VAP 40/70/100
Pole, E27



- Stainless steel 304

Product details

230V ~50Hz
Material: Stainless steel 304

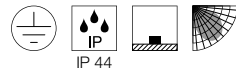

Dimensioned drawing

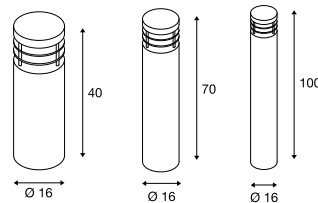

Recommended accessories

- IP68 connection box, 3-pole
Item no. 228730
- Concrete anchor
Item no. 229059

Recommended lamp

E27 9W 240°
3000K 810lm EEL=A+
10kWh/1000h
Item no. 1001031

Lamp details

max. 23W
Ø: 5.2 cm max. L: 12.1 cm max.

Variant	Item no.
E27 H: 40 cm 4.4 kg ■ stainless steel	229054
E27 H: 70 cm 6 kg ■ stainless steel	229057
E27 H: 100 cm 7.6 kg ■ stainless steel	229050





231595 555



231475 555

F-POL Pole, E27



A-A++ Range A++-E



Product details

230V ~50Hz
Material: Aluminium / Polycarbonate (PC)

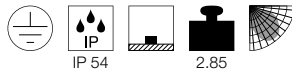

Dimensioned drawing

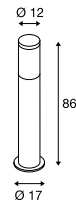

Recommended accessories

■ IP68 connection box, 3-pole
Item no. 228730



Recommended lamp

E27 15W 240°
3000K 1521lm EEL=A+
15kWh/1000h
Item no. 1001033



Lamp details

max. 20W
Ø: 5 cm max. L: 14.8 cm max.

Variant	Item no.
E27	
■ anthracite	231595

C-POL Pole, E27



A-A++ Range A++-E

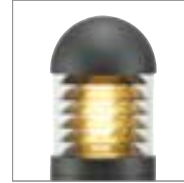

Product details

230V ~50Hz
Material: Aluminium / Polycarbonate (PC)

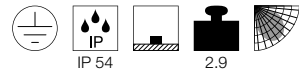

Dimensioned drawing

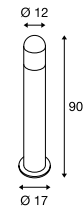

Recommended accessories

■ IP68 connection box, 3-pole
Item no. 228730



Recommended lamp

E27 9W 240°
3000K 810lm EEL=A+
10kWh/1000h
Item no. 1001031



Lamp details

max. 24W
Ø: 5.2 cm max. L: 17.3 cm max.

Variant	Item no.
E27	
■ anthracite	231475

POLE PARC
90/150/200
Pole



A-A++ Range
A+-E

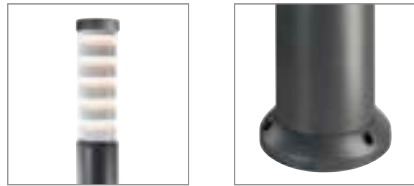

- Technical lighting system for targeted floor illumination
- Homogeneous, rotation-symmetrical light distribution
- Modern design for discreet, glare-free lighting

Product details

100-240V ~50/60Hz | 1450mA
Material: Aluminium / Plastic

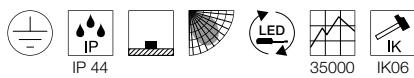

Dimensioned drawing

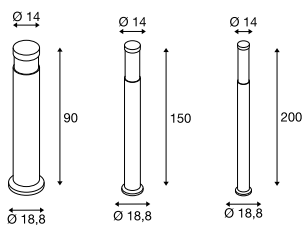

Recommended accessories

■ IP68 connection box, 3-pole
Item no. **228730**



Variant	Item no.
1000lm 3000K CRI>80 90 cm 5.2 kg 145mA 21W ■ anthracite	1000760
1800lm 3000K CRI>80 150 cm 8.3 kg 840mA 33W ■ anthracite	1000761
2600lm 3000K CRI>80 200 cm 11.5 kg 1430mA 50W ■ anthracite	1000762

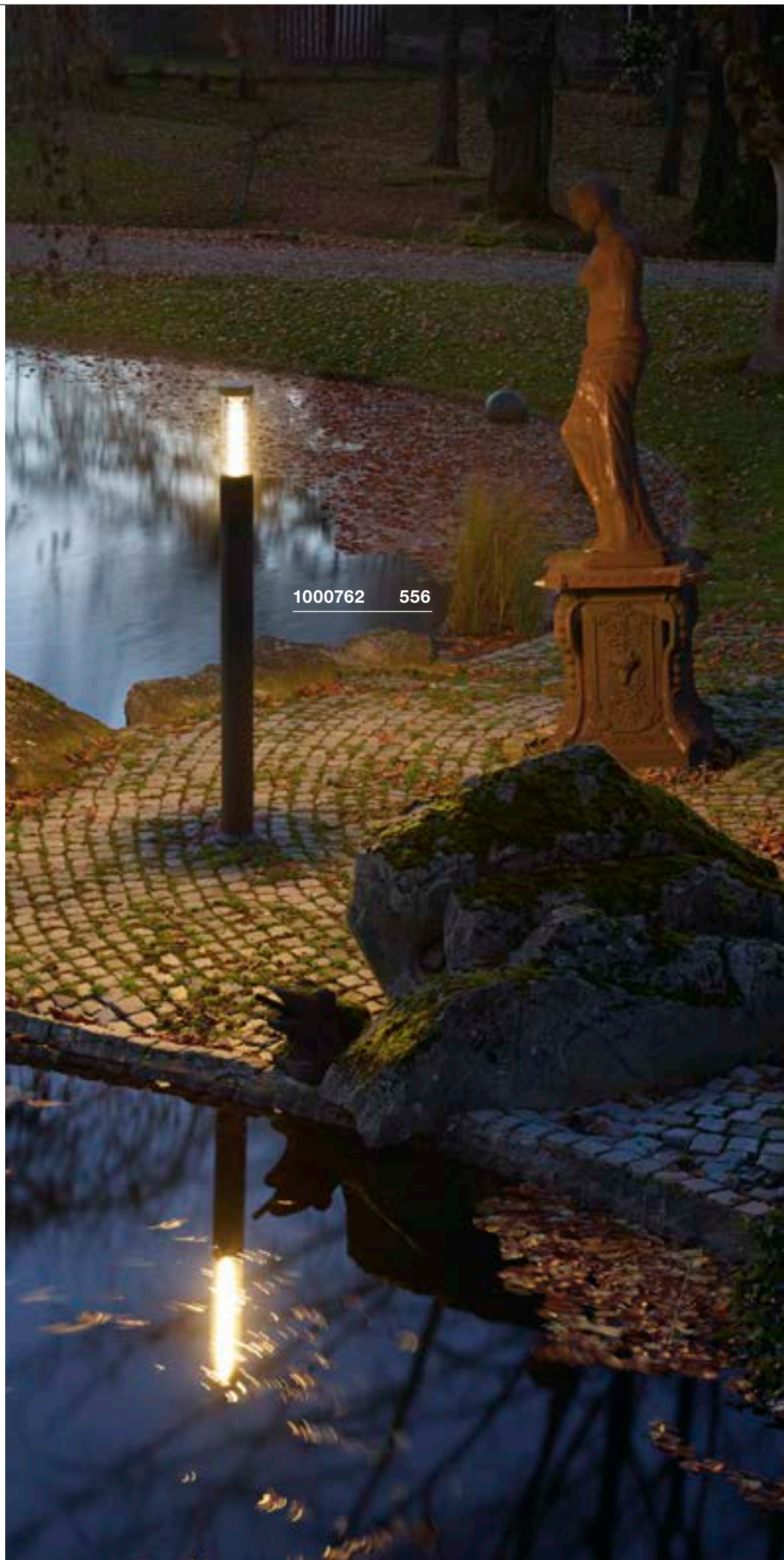

1000762 556



231225 557

GRAFIT 30/60
Pole, E27



A-A++ Range A++-E



Product details

230V ~50Hz
Material: Aluminium / Plastic

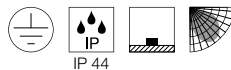

Dimensioned drawing

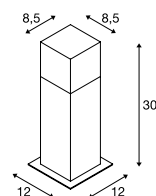

Recommended accessories

- Screw set
Item no. 228752
- Earth spike
Item no. 231230



Recommended lamp

LED E27 9.1W 240°
2700K 760lm EEL=A+
10kWh/1000h
Item no. 560402



Lamp details

max. 11W
Ø: 6 cm max. L: 11.5 cm max.

Variant	Item no.
E27 H: 30 cm 0.8 kg ■ anthracite	231215
E27 H: 60 cm 1.4 kg ■ anthracite	231225

LOGS 40/70
Pole



A-A++ Range
A++-E



Product details

100-240V ~50/60Hz | 500mA
Total consumption: 8W
Material: Aluminium

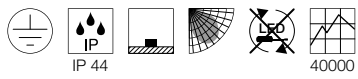

Dimensioned drawing

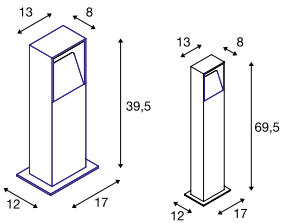

Recommended accessories

- IP68 connection box, 3-pole
Item no. 228730
- Earth spike
Item no. 231230
- Screw set
Item no. 228754
- Concrete anchor
Item no. 232119



Variant	Item no.
420lm 3000K CRI>80 H: 39.5 cm 2 kg	
■ anthracite	232115
420lm 3000K CRI>80 H: 69.5 cm 2.8 kg	
■ anthracite	232125



232125 558

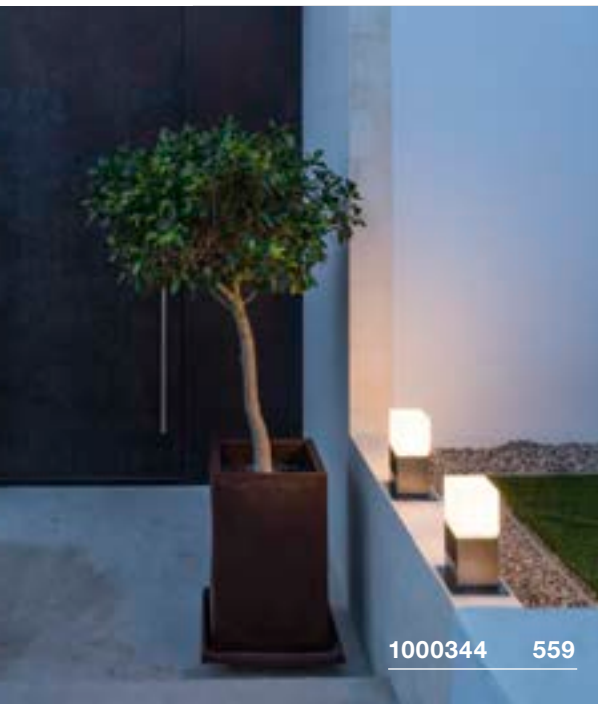

1000344 559



1000346 559



1000416 559

SQUARE POLE
30/60/90
Pole, TRIAC



A-A++ Range A++-E



- Luminaire made from stainless steel 304
- Modern design for walkway lighting
- Diffuse light distribution for brightening the surroundings

Product details

220-240V ~50/60Hz
Material: Stainless Steel 304

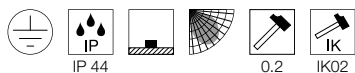

Dimensioned drawing

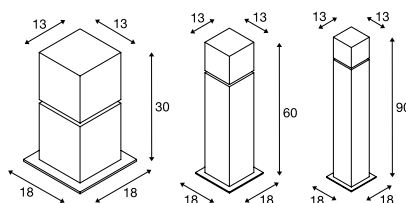

Recommended accessories

- IP68 connection box, 3-pole
Item no. 228730
- Concrete anchor
Item no. 1000343
- Earth spike
Item no. 231234

Recommended lamp

- LED E27 9.1W 240°
2700K 760lm EEL=A+
10kWh/1000h
Item no. 560402
- LED E27 9W 240°
2700-6500K 806lm EEL=A+
9kWh/1000h
Item no. 1001916

Lamp details

max. 20W
Ø: 6 cm max. L: 15 cm max.

Variant	Item no.
E27 H: 30 cm 1.2 kg ■ stainless steel	1000344
E27 H: 60 cm 2.5 kg ■ stainless steel	1000345
E27 H: 90 cm 3.9 kg ■ stainless steel	1000346

SQUARE POLE
30/60/90
Pole, TRIAC



A-A++ Range A++-E



- Luminaire made from high-quality 316 stainless steel
- Modern design for walkway lighting
- Diffuse light distribution for brightening the surroundings

Product details

220-240V ~50/60Hz
Total consumption: 12W
Material: Stainless Steel 316
Dimmable: Triac C, Triac L

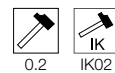

Dimensioned drawing

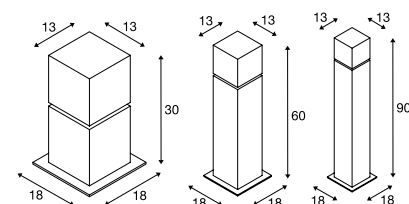

Recommended accessories

- IP68 connection box, 3-pole
Item no. 228730
- Concrete anchor
Item no. 1000343
- Earth spike
Item no. 231234

Variant	Item no.
760lm 3000K CRI>80 H: 30 cm 2 kg ■ stainless steel	1000416
760lm 3000K CRI>80 H: 60 cm 3.4 kg ■ stainless steel	1000417
760lm 3000K CRI>80 H: 90 cm 4.7 kg ■ stainless steel	1000418

RUSTY® 40/70
Pole, E27



- Rusty steel
- Each fitting is unique

Product details

230V ~50Hz
Material: FeCSi-Steel / Polycarbonate (PC)

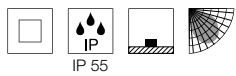

Dimensioned drawing

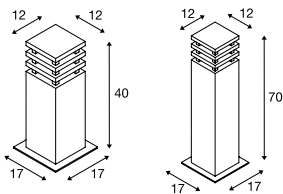

Recommended accessories

- IP68 connection box, 3-pole
Item no. 228730
- Earth spike
Item no. 229422

Recommended lamp

- E27 4.7W 360°
3000K 380lm EEL=A+
5kWh/1000h
Item no. 551532
- LED E27 9W 240°
3000K 810lm EEL=A+
10kWh/1000h
Item no. 1001031

Lamp details

max. 11W
Ø: 4.8 cm max. L: 13.9 cm max.

Variant	Item no.
E27 H: 40 cm 11 kg ■ rust	229420
E27 H: 71 cm 22 kg ■ rust	229421

RUSTY® 40/70
Pole



- Rusty steel
- Each fitting is unique
- 240V LED

Product details

220-240V ~50/60Hz
Total consumption: 8.6W
Material: FeCSi-Steel / Polycarbonate (PC)

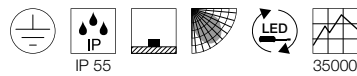

Dimensioned drawing

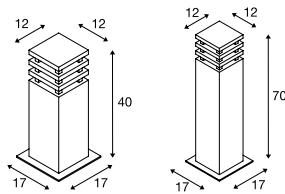

Note

Open cable end

Recommended accessories

- IP68 connection box, 3-pole
Item no. 228730
- Earth spike
Item no. 229422

Variant	Item no.
90lm 3000K CRI>80 H: 40 cm 11 kg ■ rust	233427
90lm 3000K CRI>80 H: 71 cm 22 kg ■ rust	233437



229420 560



231411 561



231410 561



231410 561

ARROCK GRANITE 40/70

Pole, square, E27

A-A++ Range A++-E



- Natural stone, granite, stainless steel
- Natural look with glare-free lighting effect

Product details

230V ~50Hz
Material: Granite / Stainless Steel 304

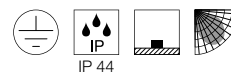

IP 44

Dimensioned drawing

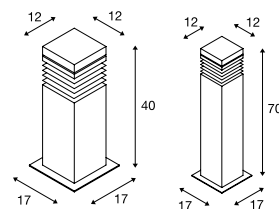

Recommended accessories

- IP68 connection box, 3-pole
Item no. 228730
- Earth spike
Item no. 229422



Recommended lamp

E27 9W 240°
3000K 810lm EEL=A+
10kWh/1000h
Item no. 1001031



Lamp details

max. 15W
Ø: 5.2 cm max. L: 11.5 cm max.

Variant	Item no.
E27 H: 40 cm 11 kg ■ grey / chrome	231410
E27 H: 70 cm 22.5 kg ■ grey / chrome	231411

ARROCK ARC
Pole, QPAR51

E-A++ Range
A++-E

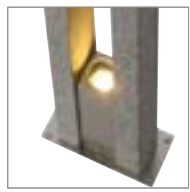

- Natural stone, granite, stainless steel
- Flat design with extraordinary lighting effect

Product details

230V ~50Hz
Material: Granite / Stainless Steel 304

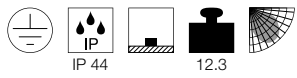

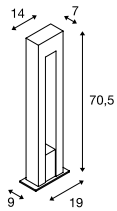

Dimensioned drawing





Recommended accessories

Earth spike 
Item no. 231233

Recommended lamp

LED GU10 5.5W 38°  
2700K 400lm EEL=A+
6kWh/1000h
Item no. 1001030

LED GU10 7.2W 36°  
4000K 540lm EEL=A+
8kWh/1000h
Item no. 1001564

Lamp details

max. 35W QPAR51
Ø: 5 cm max. L: 7.6 cm max.

Variant	Item no.
GU10 QPAR51	
grey / chrome	231420



231420 562



231817 563



231455 563

SLOTS 45 Pole



A-A++ Range A++-E



- Indirect light emission
- Unusual lighting effect for safe footin

Product details

220-240V ~50/60Hz
Total consumption: 6.3W
Material: Aluminium



Dimensioned drawing

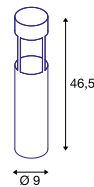

SLOTS 65 Pole



A-A++ Range A++-E

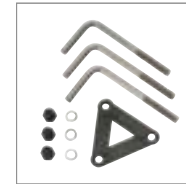

- Indirect light emission
- Unusual lighting effect for safe footin

Product details

220-240V ~50/60Hz
Total consumption: 6.3W
Material: Aluminium



Dimensioned drawing

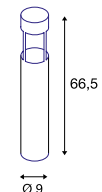

Recommended accessories

- IP68 connection box, 3-pole
Item no. 228730
- screw set
Item no. 228753



Variant	Item no.
200lm 3000K CRI>80	
■ anthracite	231815
200lm 3000K CRI>80	
■ rust	231817

Recommended accessories

- IP68 connection box, 3-pole
Item no. 228730
- screw set
Item no. 228753



Variant	Item no.
200lm 3000K CRI>80	
■ anthracite	231455
200lm 3000K CRI>80	
■ rust	231457

BOOKAT
Pole, TRIAC

A-A++ Range A++-E

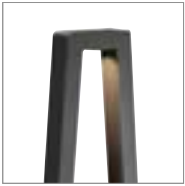

• 240V LED

Product details

230V ~50Hz
Total consumption: 13W
Material: Aluminium
Dimmable: Triac C, Triac L

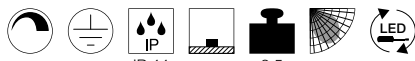

50000

Dimensioned drawing

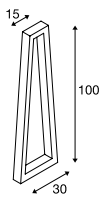

Note

Open cable end

Recommended accessories

■ IP68 connection box, 3-pole
Item no. **228730**



Variant	Item no.
370lm 3000K CRI>80	
■ anthracite	231855

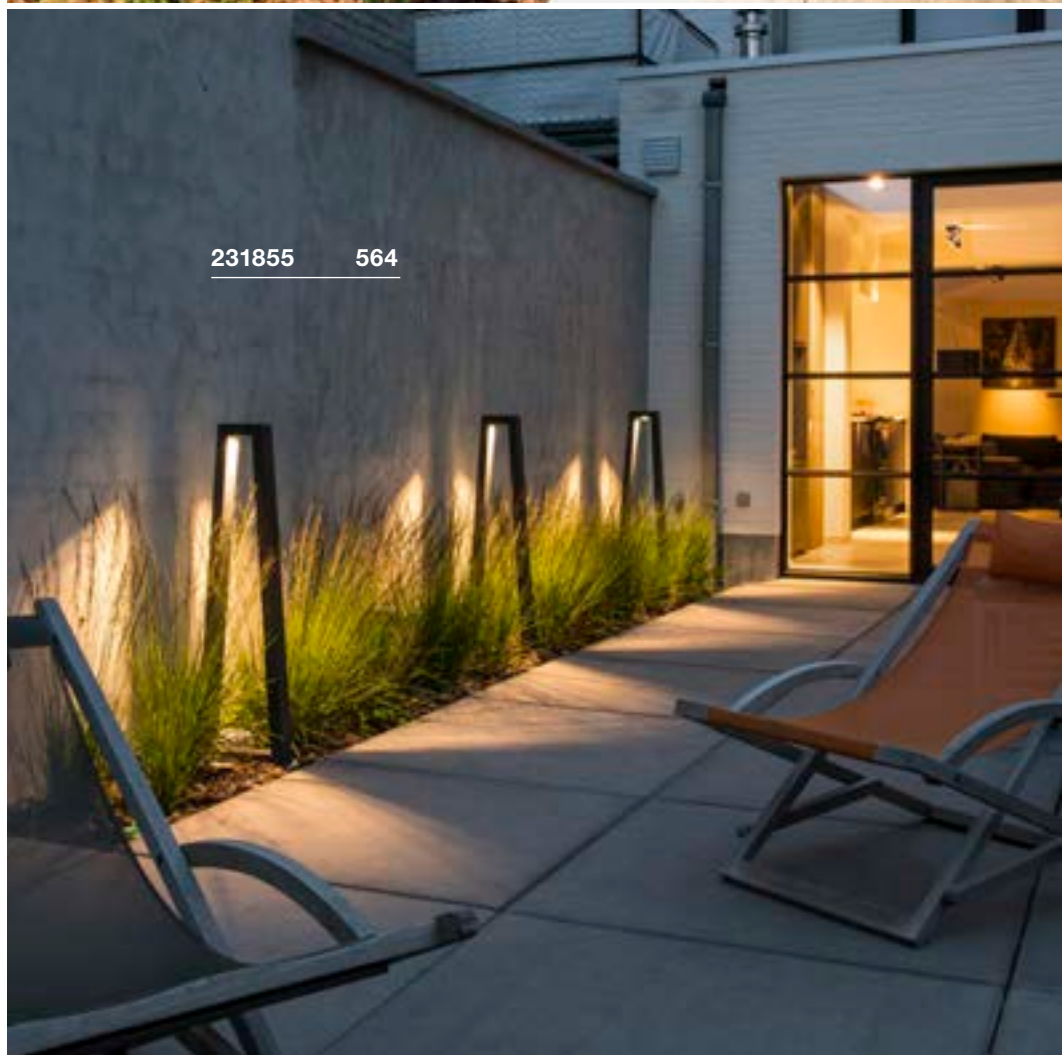



1000801 565

RASCALI 45/65 Pole



A-A++ Range A++-E



- Unusual design
- Axis-symmetrical light distribution for accentuating paths and surfaces

Product details

220-240V ~50Hz
 Total consumption: 8W
 Material: Aluminium

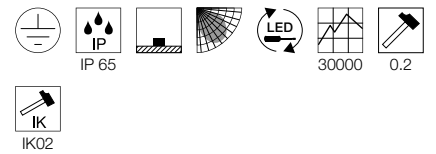

Dimensioned drawing

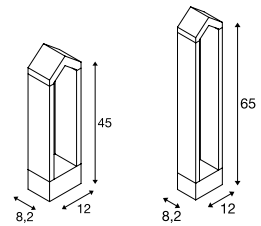

Variant	Item no.
360lm 3000K CRI>80 H: 45 cm 2.25 kg ■ anthracite	100799
360lm 3000K CRI>80 H: 65 cm 2.8 kg ■ anthracite	1000801

H-POL 30/60 Pole

A-A++ Range A++-E



- One-sided light emission

Product details

100-277V ~50/60Hz | 500mA
 Material: Aluminium / Plastic
 Installation dimensions:
 W: 11.8 cm L: 11.8 cm D: 10 cm

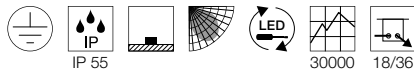

Dimensioned drawing

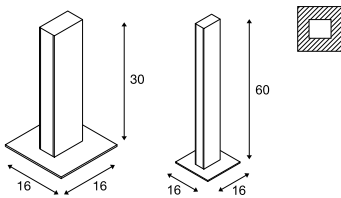

Note

The product is intended for inground installation. A large mounting pot is available for optimum inground installation. Installation dimensions of the optional installation pot:
 L: 14 cm W: 14 cm D: 16 cm.

Recommended accessories

■ Installation pot
 Item no. **232195**

Variant	Item no.
350lm 3000K CRI>80 9W H: 36 cm 1.4 kg ■ anthracite	232155
700lm 3000K CRI>80 18W H: 66 cm 2.3 kg ■ anthracite	232165

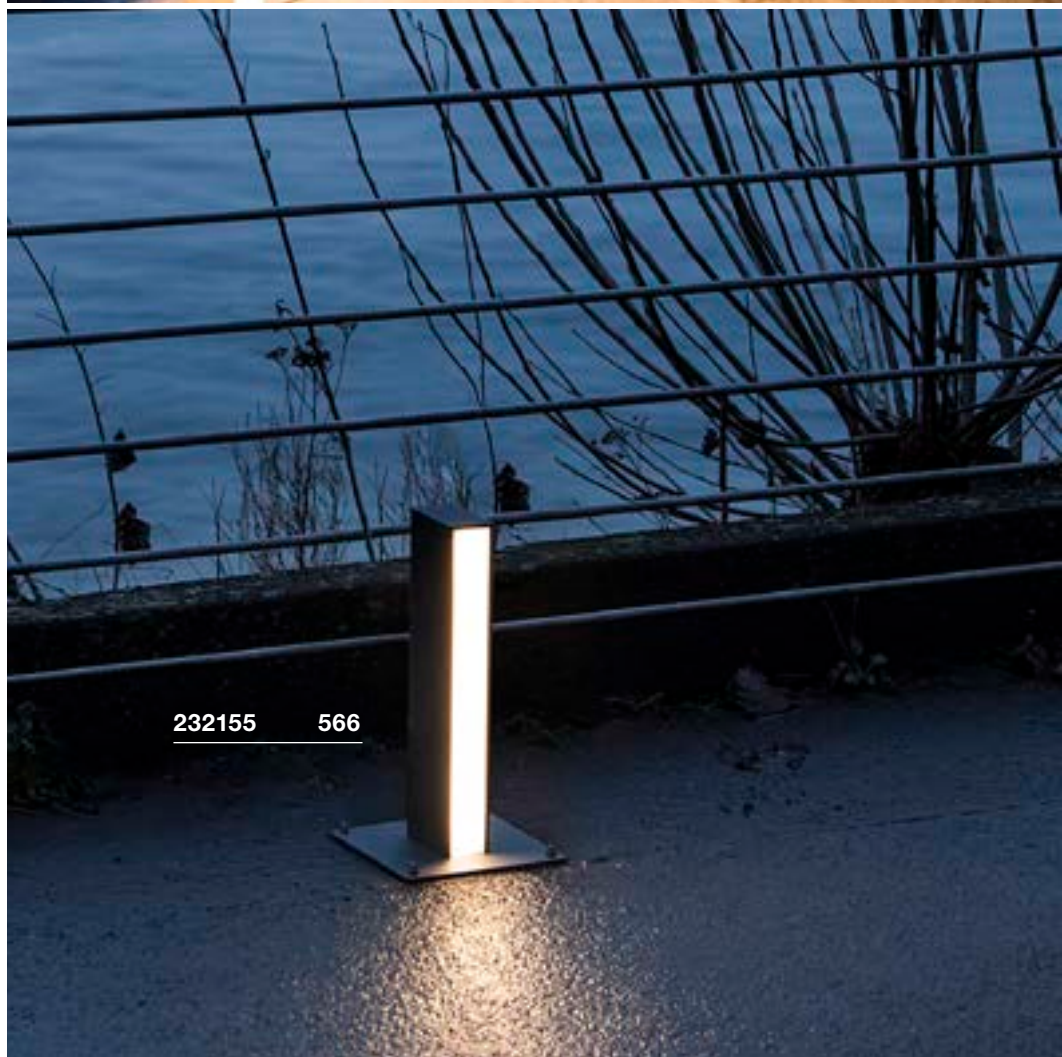
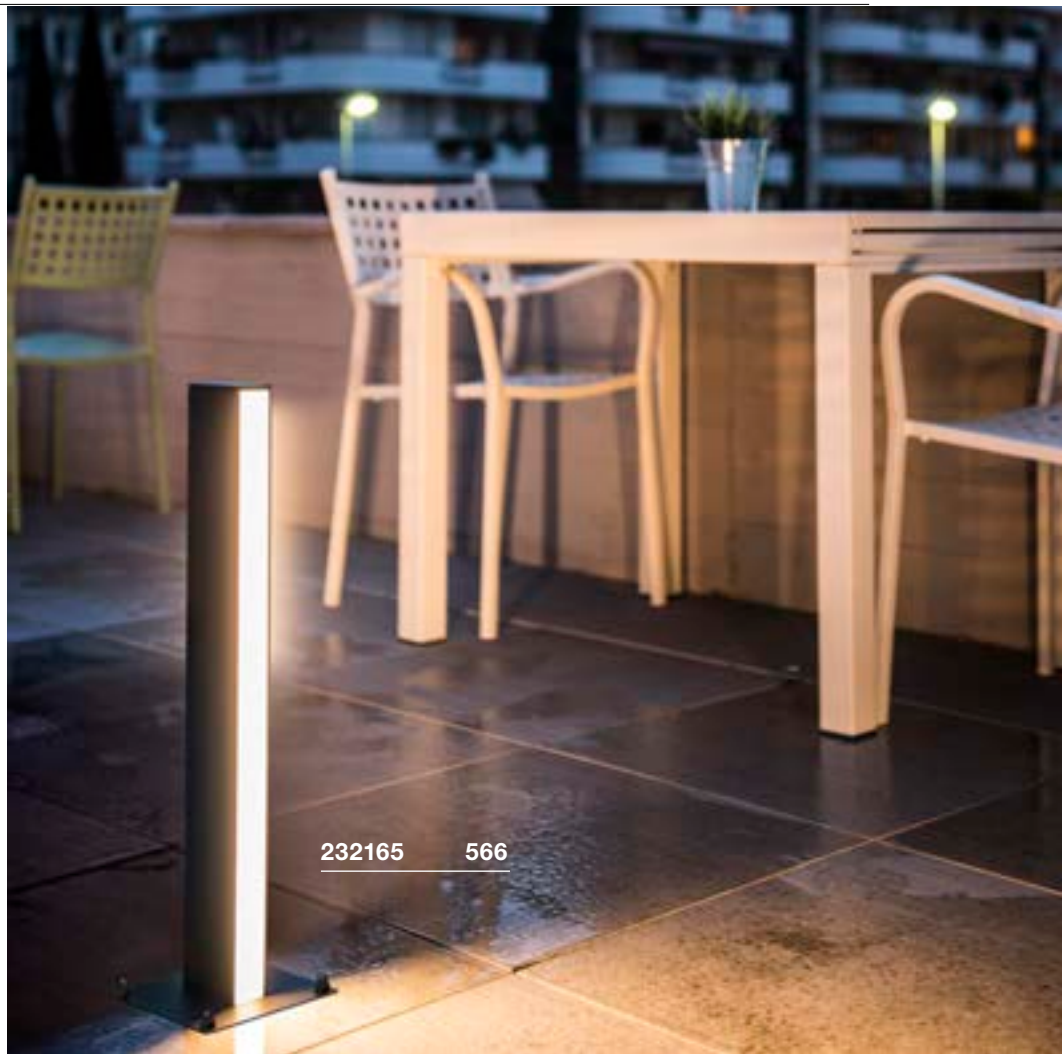



232175 567

H-POL TWIN 30/60 Pole

A-A++ Range A++-E

LED INSIDE



- Two-sided light emission

Product details

220-240V ~50/60Hz | 1000mA
 Material: Aluminium / Plastic
 Installation dimensions:
 W: 11.8 cm L: 11.8 cm D: 10 cm

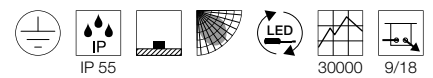

Dimensioned drawing

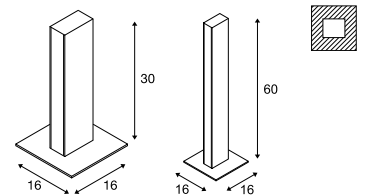

Note

The product is intended for inground installation. A large mounting pot is available for optimum inground installation. Installation dimensions of the optional mounting pot:
 L: 14 cm W: 14 cm D:16 cm.

Recommended accessories

■ Installation pot
 Item no. 232195

Variant	Item no.
Direct: 350lm 3000K CRI>80 Indirect: 350lm 3000K CRI>80 18W H: 36 cm 1.6 kg	
■ anthracite	232175
Direct: 700lm 3000K CRI>80 Indirect: 700lm 3000K CRI>80 35W H: 66 cm 2.5 kg	
■ anthracite	232185

SLOTBOX 40/70
Pole

A-A++ Range A++-E

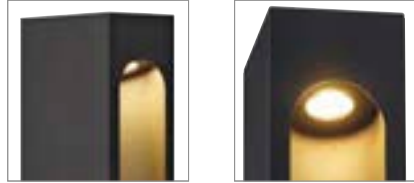

Product details

200-240V ~50/60Hz | 700mA
Total consumption: 8W
Material: Aluminium

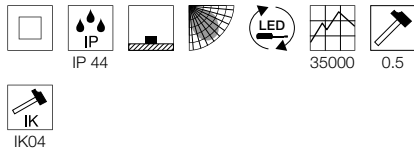

Dimensioned drawing

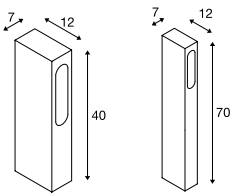

Note

Open cable end

Recommended accessories

■ IP68 connection box, 3-pole
Item no. 228730



Variant	Item no.
160lm 3000K CRI>80 H: 40 cm 1.45 kg ■ anthracite	232135
160lm 3000K CRI>80 H: 70 cm 2.1 kg ■ anthracite	232145



232135 568

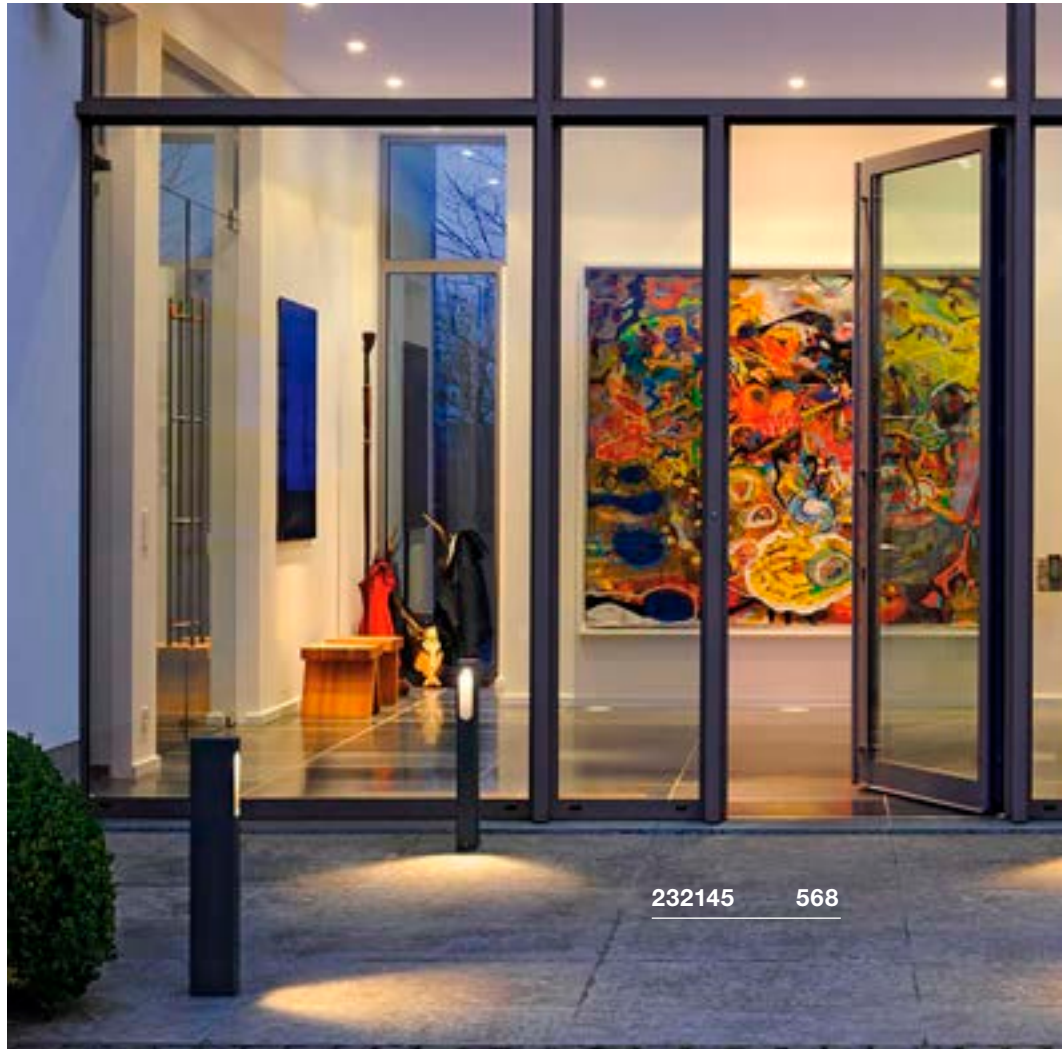

232145 568



1002958 569

FLATT 65/100 Pole

887

A-A++ Range A++-E

LED INSIDE

NEW



- Switchable light colour

Product details

100-240V ~50/60Hz | 350mA
 Total consumption: 9.7W
 Material: Aluminium / Aluminium

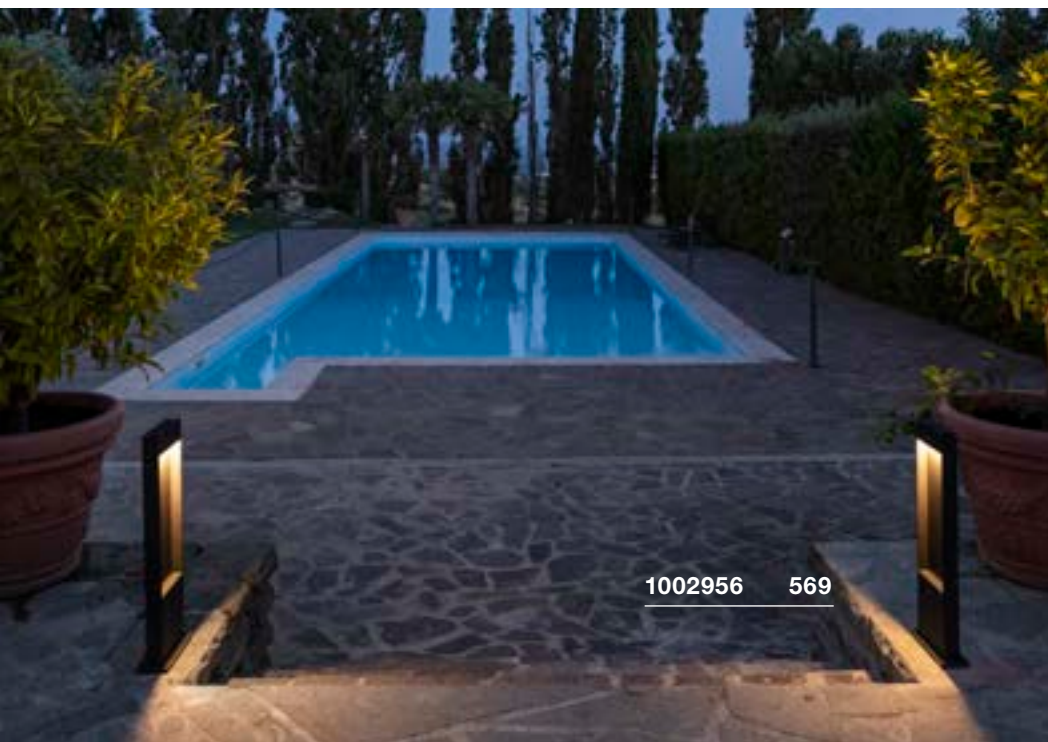
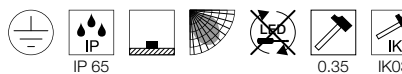

1002956 569

Variant	Item no.
400lm 3000/4000K CRI80 L: 18 cm W: 4.5 cm H: 65 cm 3.2 kg ■ matt anthracite / matt anthracite	1002956
400lm 3000/4000K CRI80 L: 18 cm W: 4.5 cm H: 65 cm 3.2 kg ■ matt anthracite / matt brown	1002957
400lm 3000/4000K CRI80 L: 18 cm W: 4.5 cm H: 100 cm 4.47 kg ■ matt anthracite / matt anthracite	1002958
400lm 3000/4000K CRI80 L: 18 cm W: 4.5 cm H: 100 cm 4.47 kg ■ matt anthracite / matt brown	1002959

ARROCK STONE 50/70
Pole



- Basalt / stainless steel
- Unusual lighting effect

Product details

100-240V ~50/60Hz | 700mA
Total consumption: 9W
Material: Granite / Stainless Steel 304

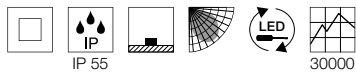

Dimensioned drawing

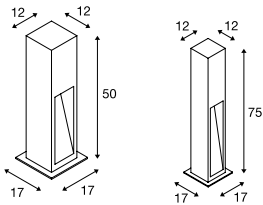

Recommended accessories

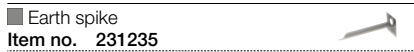

Variant	Item no.
330lm 3000K CRI>80 H: 50 cm 15.5 kg grey	231370
330lm 3000K CRI>80 H: 75 cm 22.2 kg grey	231371

ARROCK SLOT
Pole, QPAR51



- Natural stone, granite, stainless steel
- Unusual lighting effect, natural look

Product details

230V ~50Hz
Material: Granite / Stainless Steel 304

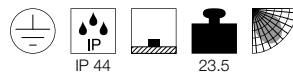

Dimensioned drawing

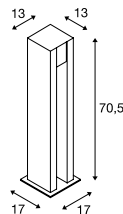

Note

Open cable end

Recommended accessories



Recommended lamp

LED GU10 3.7W 36°
2700K 260lm EEL=A+
4kWh/1000h
Item no. 560122

Lamp details

max. 4W LED GU10 51mm

Variant	Item no.
GU10 LED GU10 51mm grey / chrome	231440

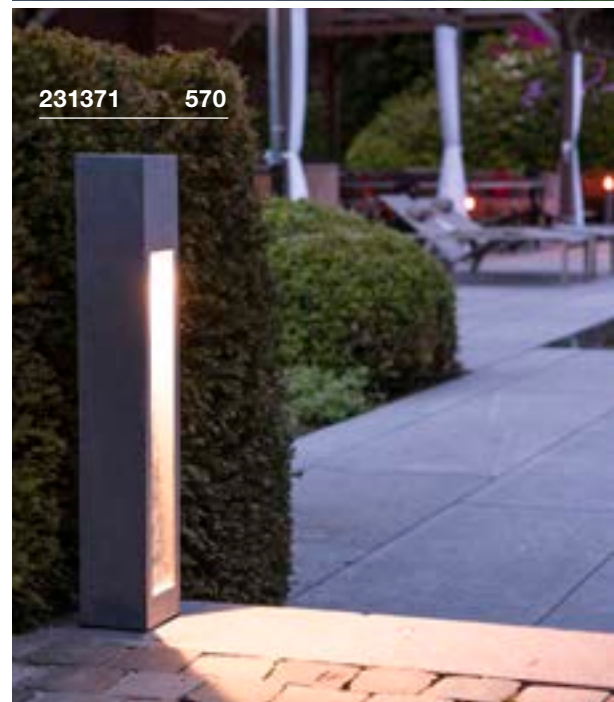
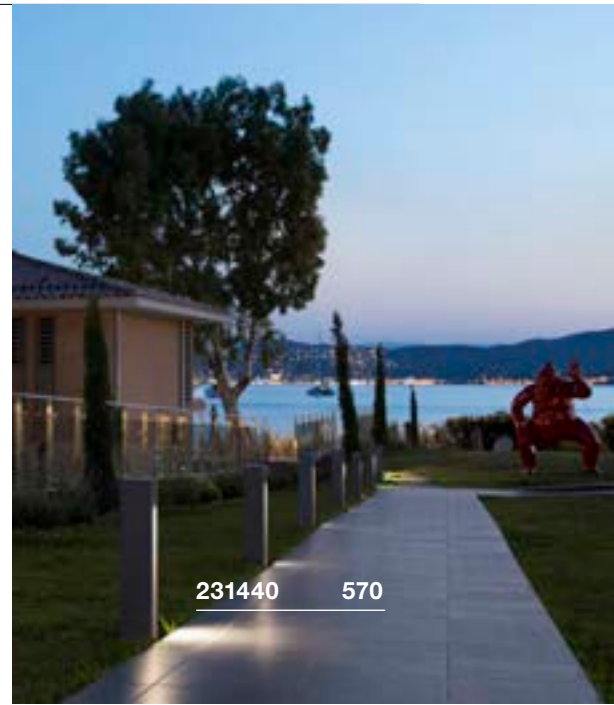



229411 571



229410 571



233447 571

RUSTY® SLOT 50/80 Pole, E27

A-A++ Range A++-E



- Rusty steel
- Each fitting is unique
- Unusual lighting effect

Product details

230V ~50Hz
Material: FeCSI-Steel / Polycarbonate (PC)

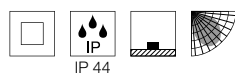

Dimensioned drawing

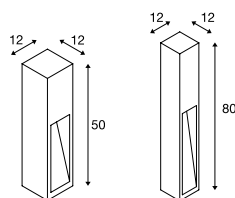

Recommended accessories

- IP68 connection box, 3-pole
Item no. 228730
- Earth spike
Item no. 231230

Recommended lamp

- E27 4.7W 360°
3000K 380lm EEL=A+
5kWh/1000h
Item no. 551532
- LED E27 9W 240°
3000K 810lm EEL=A+
10kWh/1000h
Item no. 1001031

Lamp details

max. 11W
Ø: 4.8 cm max. L: 13.9 cm max.

Variant	Item no.
E27 H: 50 cm 12.5 g ■ rust	229410
E27 H: 80 cm 18.5 g ■ rust	229411

RUSTY® SLOT 50/80 Pole

A-A++ Range A++-E

LED INSIDE



- Rusty steel
- Each fitting is unique
- Unusual lighting effect

Product details

220-240V ~50/60Hz
Total consumption: 8.6W
Material: FeCSI-Steel / Polycarbonate (PC)

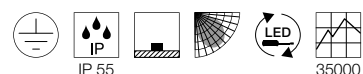

Dimensioned drawing

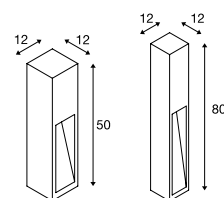

Note

Open cable end

Recommended accessories

- IP68 connection box, 3-pole
Item no. 228730
- Earth spike
Item no. 231230

Variant	Item no.
30lm 3000K CRI>80 H: 50 cm 12.5 g ■ rust	233447
30lm 3000K CRI>80 H: 80 cm 18.5 g ■ rust	233457

BENDO 80/220
Pole, TRIAC



A-A++ Range A++-E

LED INSIDE



reddot award 2018 winner

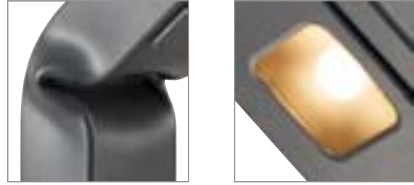

- 240V LED
- Exclusive design for an extraordinary outdoor area

Product details

220-240V ~50/60Hz
Material: Aluminium / Glass
Dimmable: Triac C, Triac L

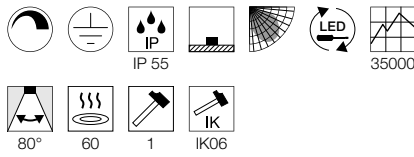

Dimensioned drawing

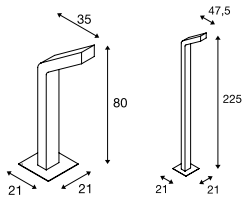

Recommended accessories

- Concrete anchor
Item no. **231849**
- IP68 connection box, 3-pole
Item no. **228730**
- T-connector box
Item no. **228726**

Variant	Item no.
700lm 3000K CRI>80 H: 80 cm 11W 2.7 kg ■ anthracite	231835
1800lm 3000K CRI>80 H: 225 cm 31W 7.3 kg ■ anthracite	231845



reddot award 2018 winner

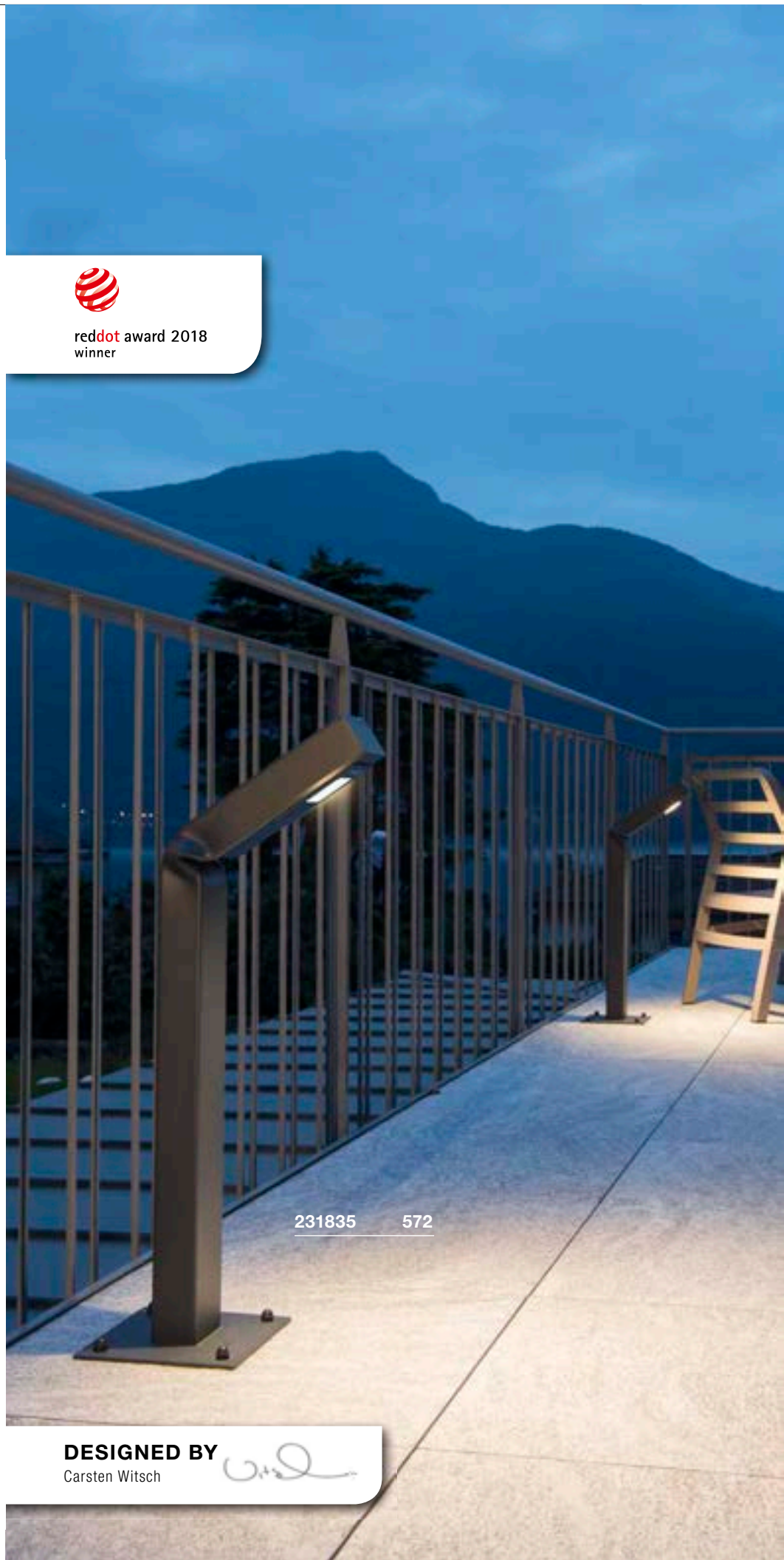

231835 572

DESIGNED BY
Carsten Witsch





230090 573



230090 573



1001824 573

RUSTY® PATHLIGHT Pole, TCR-TSE

B-A++ Range A++-E



- Rusty steel
- Each fitting is unique
- Straight-lined, natural look

Product details

230V ~50Hz
Material: FeCSi-Steel / Polycarbonate (PC)

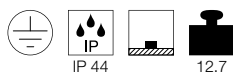

Dimensioned drawing

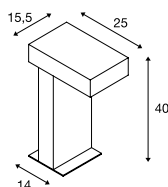

Recommended accessories

- IP68 connection box, 3-pole
Item no. 228730
- Earth spike
Item no. 229422



Recommended lamp

GX53 3W 120°
3000K 250lm EEL=A++
3kWh/1000h
Item no. 551372



Lamp details

max. 9W TCR-TSE
Ø: 7.5 cm max. L: 2.7 cm max.

Variant	Item no.
GX53 TCR-TSE	
■ rust	230090

RUSTY® PATHLIGHT 40/70 Pole

A-A++ Range A++-E



LED INSIDE



- Rusty steel
- Each fitting is unique

Product details

220-240V ~50/60Hz
Total consumption: 8.9W
Material: FeCSi-Steel / Polycarbonate (PC)

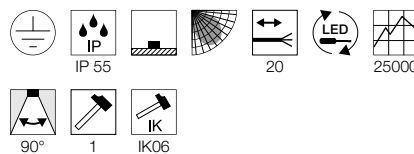

Dimensioned drawing

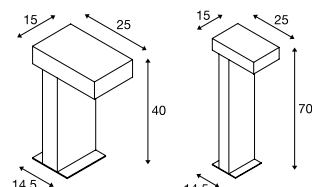

Note

Open cable end

Recommended accessories

- IP68 connection box, 3-pole
Item no. 228730
- Earth spike
Item no. 229422



Variant	Item no.
400lm 3000K CRI>80 H: 40 cm 12.5 kg	
■ rust	1001823
400lm 3000K CRI>80 H: 70 cm 18.9 kg	
■ rust	1001824

ABRIDOR 60/100
Pole



A-A++ Range A++-E

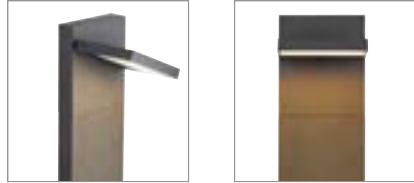

- Switchable light colour
- Tilting lamp head

Product details

100-277V ~50/60Hz | 300mA
 Total consumption: 14W
 Material: Aluminium
 Product dimensions: 14 cm W: 3.6 cm H: 60 cm

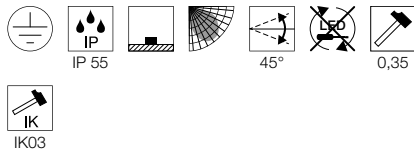

Note

Open cable end

Recommended accessories

■ IP68 connection box, 3-pole
Item no. 228730

Variant	Item no.
750lm 3000/4000K CRI80 H: 60 cm 2.3 kg ■ matt anthracite	1002991
750lm 3000/4000K CRI80 H: 100 cm 3.4 kg ■ matt anthracite	1002992



1002992 574

231355 641



231305 575



232294 575



232294 575

IPERI 50 Pole



A-A++ Range A++-E



QUADRASYL 75 Pole, TCR-TSE



B-A++ Range A++-E



- Walkway light for entrance and garden

Product details

230V ~50Hz
Total consumption: 5W
Material: Aluminium / Plastic



Dimensioned drawing

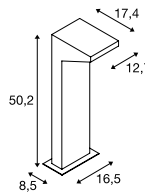

Product details

220-240V ~50/60Hz
Material: Aluminium

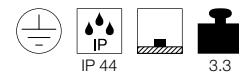

Dimensioned drawing

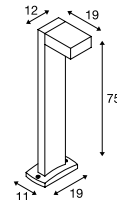

Recommended accessories

■ Earth spike
Item no. 231231

Recommended accessories

■ T-connector box
Item no. 228726

Recommended lamp

GX53 3W 120°
3000K 250lm EEL=A++
3kWh/1000h
Item no. 551372

Lamp details

max. 11W TCR-TSE
Ø: 7.5 cm max. L: 2.7 cm max.

Variant	Item no.
320lm 4000K CRI>70	
■ anthracite	231305

Variant	Item no.
GX53 TCR-TSE	
■ grey	232294
GX53 TCR-TSE	
■ anthracite	232295

TRAPECCO
Pole

 898

A-A++ Range A++-E



MALU
Pole

 890

A-A++ Range A++-E



reddot award 2019 winner



- Unusual design
- Homogeneous illumination of paths and areas
- Extremely wide light distribution

Product details

230V ~50Hz
Total consumption: 10W
Material: Aluminium

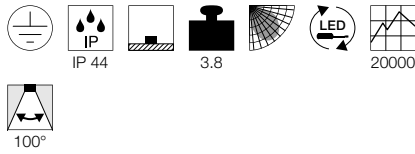

Dimensioned drawing

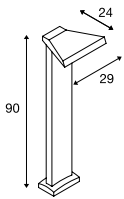

Note

Open cable end

Product details

220-240V ~50/60Hz
Total consumption: 9.2W
Material: Aluminium / Glass

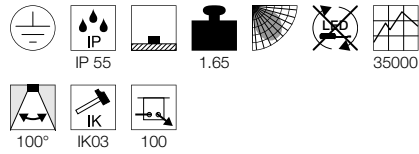

Dimensioned drawing

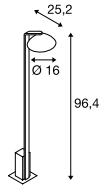

Note

Integrated connection box

Recommended accessories

■ IP68 connection box, 3-pole
Item no. 228730



Variant	Item no.
850lm 3000K CRI>80 ■ anthracite	231765

Variant	Item no.
360lm 3000K CRI>80 ■ anthracite	1002158

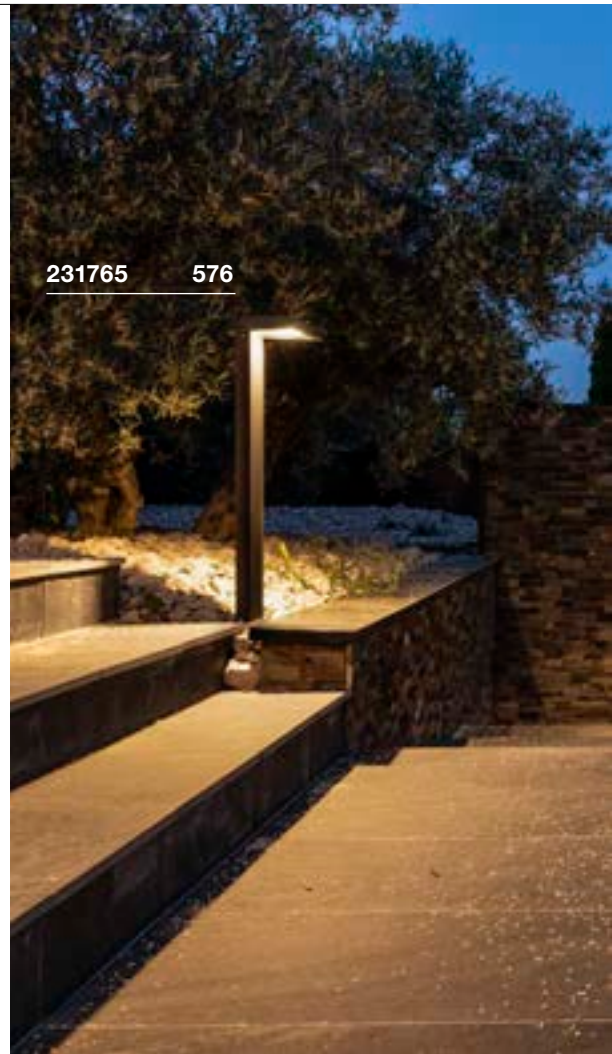

231765 576



reddot award 2019 winner

1002158 576

DESIGNED BY
Philippe Stephant

Philippe Stephant



228545 577



1002907 577

ENOLA C Pole



A-A++ Range A++-E



Product details

100-240V ~50/60Hz | 500mA
Total consumption: 12W
Material: Aluminium / Glass

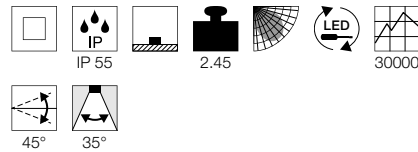

Dimensioned drawing

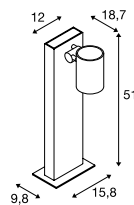

Note

Open cable end

Recommended accessories

■ IP68 connection box, 3-pole
Item no. 228730



Variant	Item no.
800lm 3000K CRI>80 ■ anthracite	228545

ESKINA 30/80 Pole



A-A++ Range A++-E



Product details

220-240V ~50/60Hz | 350mA
Total consumption: 14.5W
Material: Aluminium
Dimmable: Triac C

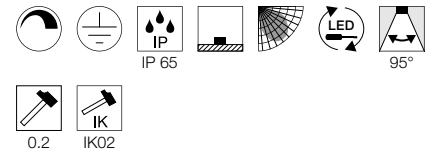

Dimensioned drawing

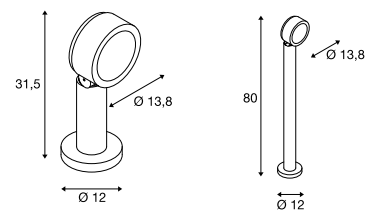

Note

1002906 - IP 2-pin mains plug
1002907 - Open cable end

Recommended accessories

■ Earth spike
Item no. 230060



Variant	Item no.
1000lm 3000/4000K CRI>80 Ø: 31.5 cm 1.3 kg ■ matt anthracite	1002906
1000lm 3000/4000K CRI>80 Ø: 80 cm 1.89 kg ■ matt anthracite	1002907

THEO PATHLIGHT
Pole, single



A-A++ Range A++-E



THEO PATHLIGHT
Pole, double



A-A++ Range A++-E



Product details

200-240V ~50/60Hz
Material: Aluminium
Product dimensions: W: 14 cm H: 72.5 cm

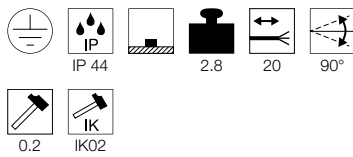

Product details

200-240V ~50/60Hz
Material: Aluminium
Product dimensions: W: 21.2 cm H: 72.5 cm

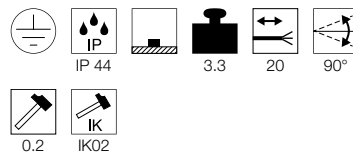

Note

Open cable end

Note

Open cable end

Recommended lamp

LED GU10 3.7W 36°
2700K 260lm EEL=A+
4kWh/1000h
Item no. 560122



Recommended lamp

LED GU10 3.7W 36°
2700K 260lm EEL=A+
4kWh/1000h
Item no. 560122



Lamp details

max. 7W

Variant	Item no.
GU10 ■ matt anthracite	1002870

Lamp details

2x max. 7W

Variant	Item no.
GU10 ■ matt anthracite	1002871



1002871 578



1003001 579

QUAD POLE

894

A-A++ Range A++-E

LED INSIDE

NEW

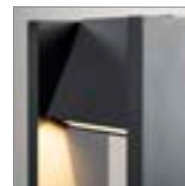

- Tilting lamp head

Product details

100-277V ~50/60Hz | 500mA
 Total consumption: 18W
 Material: Aluminium / Glass
 Product dimensions: L: 12 cm W: 23 cm H: 90 cm

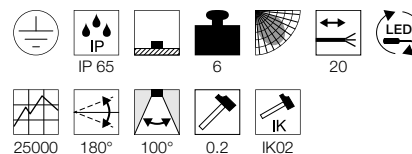

Dimensioned drawing

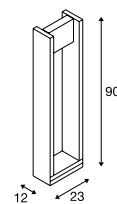

Note

Open cable end

Recommended accessories

■ IP68 connection box, 3-pole
 Item no. 228730



Variant	Item no.
1550lm 3000K CRI>80 ■ matt anthracite	1003001

HELIA
Pole, single, TRIAC



A-A++ Range A++-E



- 240V LED

Product details

220-240V ~50/60Hz
Total consumption: 8W
Material: Aluminium / Glass
Dimmable: Triac C, Triac L

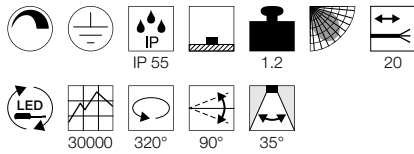

Dimensioned drawing

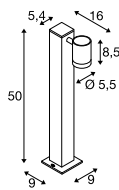

Note

Open cable end

Recommended accessories

- Earth spike
Item no. 1000736
- IP68 connection box, 3-pole
Item no. 228730

Variant	Item no.
450lm 3000K CRI>80 ■ anthracite	1002198

HELIA SENSOR
Single



A-A++ Range A++-E



- Integrated infrared sensor
- 240V LED

Product details

220-240V ~50/60Hz
Total consumption: 8W
Material: Aluminium

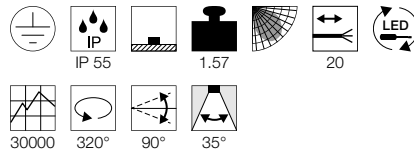

Dimensioned drawing

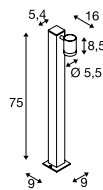

Note

Open cable end

Recommended accessories

- Earth spike
Item no. 1000736
- IP68 connection box, 3-pole
Item no. 228730

Variant	Item no.
450lm 3000K CRI>80 ■ anthracite	1002199

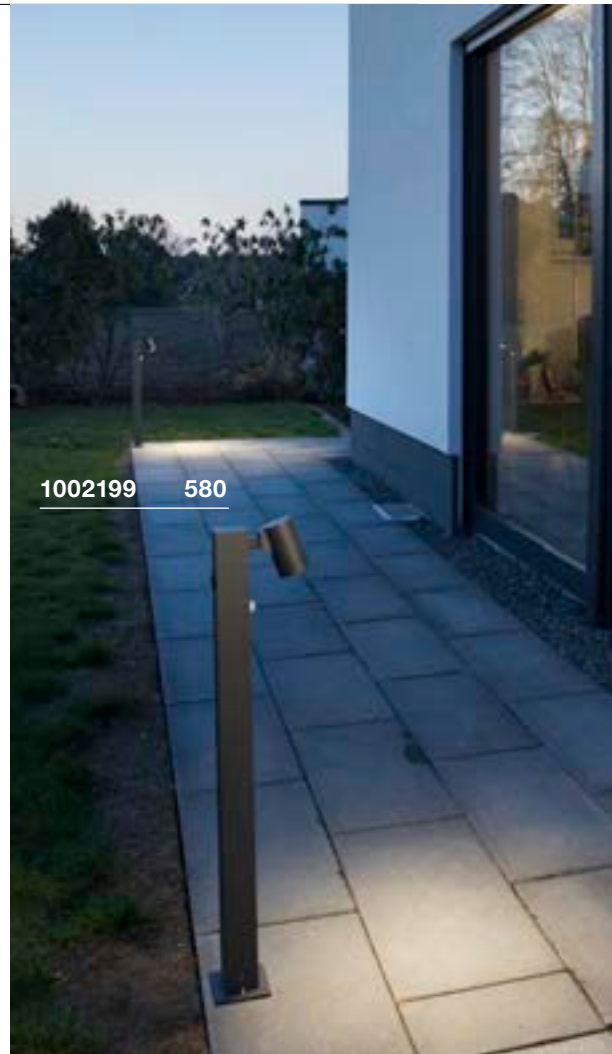

1002199 580

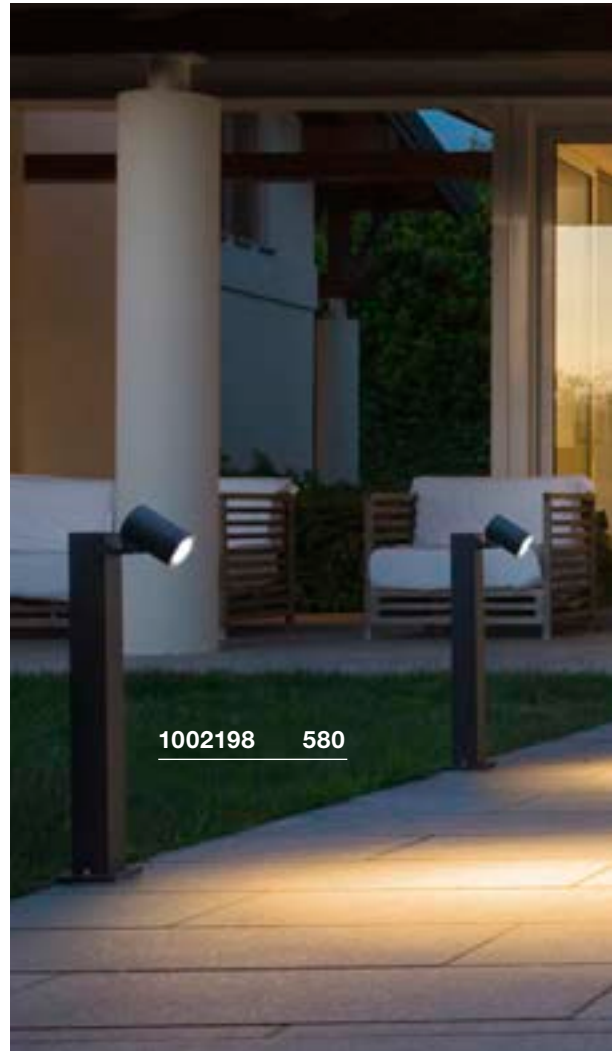

1002198 580



1002200 581

HELIA
Pole, double, TRIAC



A-A++ Range A++-E



• 240V LED

Product details

220-240V ~50/60Hz
Total consumption: 16W
Material: Aluminium / Glass
Dimmable: Triac C, Triac L

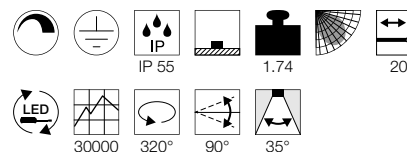

Dimensioned drawing

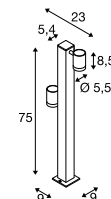

Note

Open cable end

Recommended accessories

- Earth spike
Item no. 1000736
- IP68 connection box, 3-pole
Item no. 228730

Variant	Item no.
900lm 3000K CRI>80 ■ anthracite	1002200

SITRA 360 Pole, TCR-TSE



B-A++ Range A++-E



231505 582

Product details

230V ~50Hz
Material: Aluminium / Glass



Dimensioned drawing

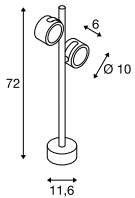

Recommended accessories

Earth spike
Item no. 230060

Recommended lamp

GX53 3W 120°
3000K 250lm EEL=A++
3kWh/1000h
Item no. 551372



LED GX53 8.2W 120°
4000K 620lm EEL=A+
9kWh/1000h
Item no. 550074



Lamp details

2x max. 9W TCR-TSE
Ø: 7.5 cm max. L: 3.5 cm max.

Variant	Item no.
GX53 TCR-TSE	
anthracite	231505



233285 583



MYRA SPOT
Double, GU10



A-A++ Range A++-E



- Can be extended
- Unusual design for safe footing

Product details

220-240V ~50/60Hz
Material: Aluminium



Dimensioned drawing

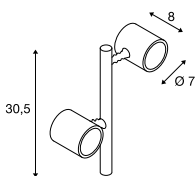

Note

The luminaire height can be increased by max. 2 extension rods.
Open cable end

Recommended accessories

- Screw set
Item no. 228752
- Concrete anchor
Item no. 228712
- Extension rod 30 cm
Art. Nr. 233164
- Stand
Item no. 233144
- Extension rod 30 cm
Item no. 233165
- Stand
Item no. 233145

Recommended lamp

- LED GU10 3.7W 36°
2700K 260lm EEL=A+
4kWh/1000h
Item no. 560122

Lamp details

2x max. 4.5W LED GU10 51mm
Ø: 5 cm max. L: 5.7 cm max.

Variant	Item no.
GU10 LED GU10 51mm ■ grey	233184
GU10 LED GU10 51mm ■ anthracite	233185

HELIA
Pole, single, TRIAC



A-A++ Range A++-E



- 240V LED

Product details

220-240V ~50/60Hz
Total consumption: 8W
Material: Aluminium
Dimmable: Triac C, Triac L

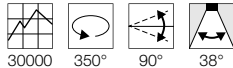

Dimensioned drawing

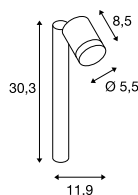

Note

The luminaire height can be increased by max. 2 extension rods.
Open cable end

Recommended accessories

- Extension rod 30 cm
Item no. 233165
- Stand
Item no. 233145
- Screw set
Item no. 228752
- Concrete anchor
Item no. 228712

Variant	Item no.
450lm 3000K CRI>80 ■ anthracite	233275

HELIA
Pole, double, TRIAC



A-A++ Range A++-E



- 240V LED

Product details

220-240V ~50/60Hz
Total consumption: 16W
Material: Aluminium
Dimmable: Triac C, Triac L

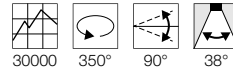
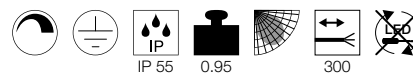

Dimensioned drawing

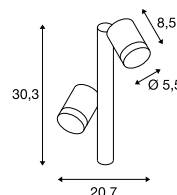

Note

The luminaire height can be increased by max. 2 extension rods.
Open cable end

Recommended accessories

- Extension rod 30 cm
Item no. 233165
- Stand
Item no. 233145
- Screw set
Item no. 228752
- Concrete anchor
Item no. 228712

Variant	Item no.
900lm 3000K CRI>80 ■ anthracite	233285

THE SUN'S COMING UP.

FLOODLIGHTS CREATE
DYNAMIC LIGHT EMPHASIS.

Do you want effective outdoor lighting
If so, discover the wide range of floodlights which make individual
lighting possible. On buildings, squares, pavements and in gardens.





231035 589

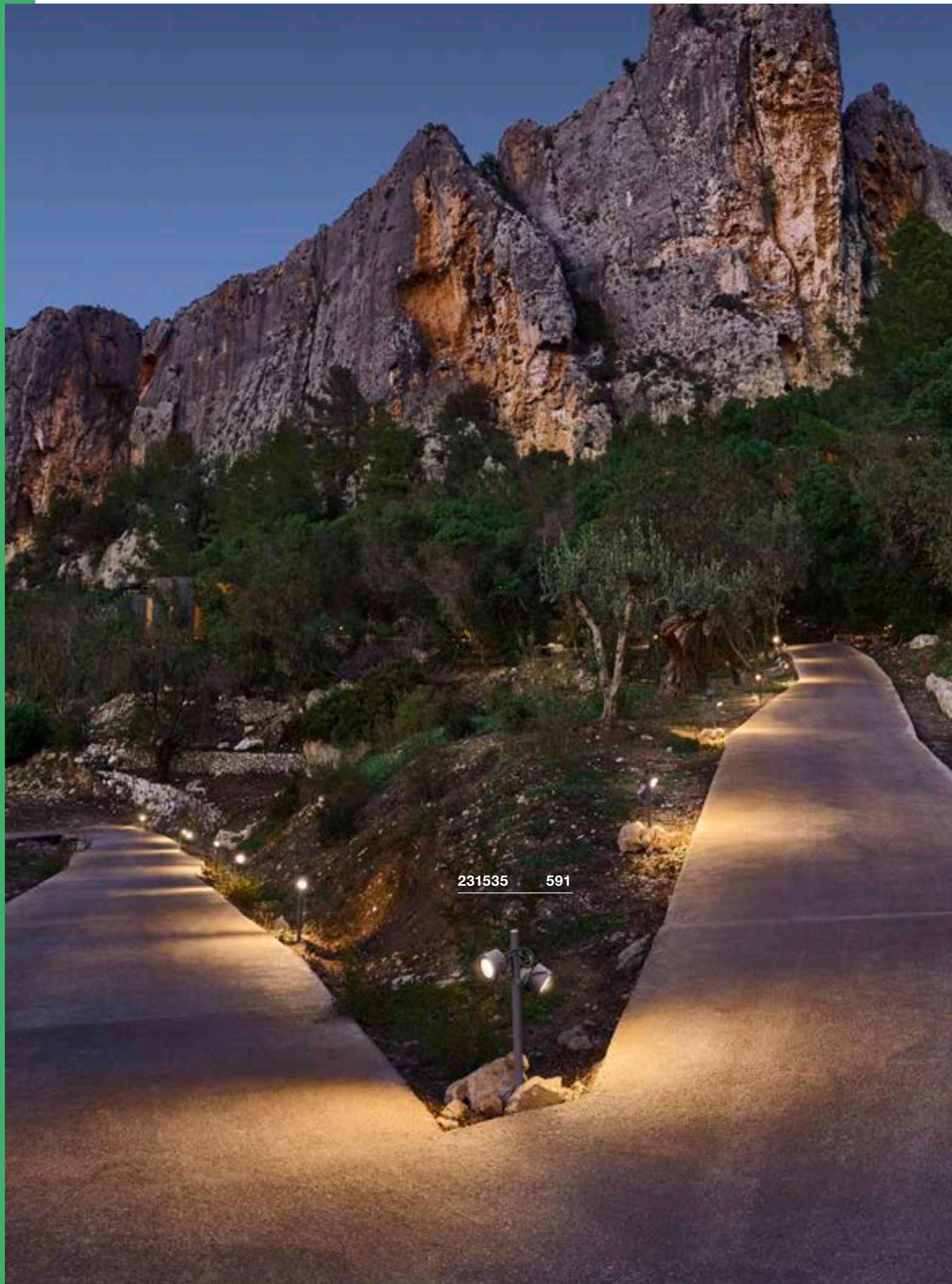

231535 591

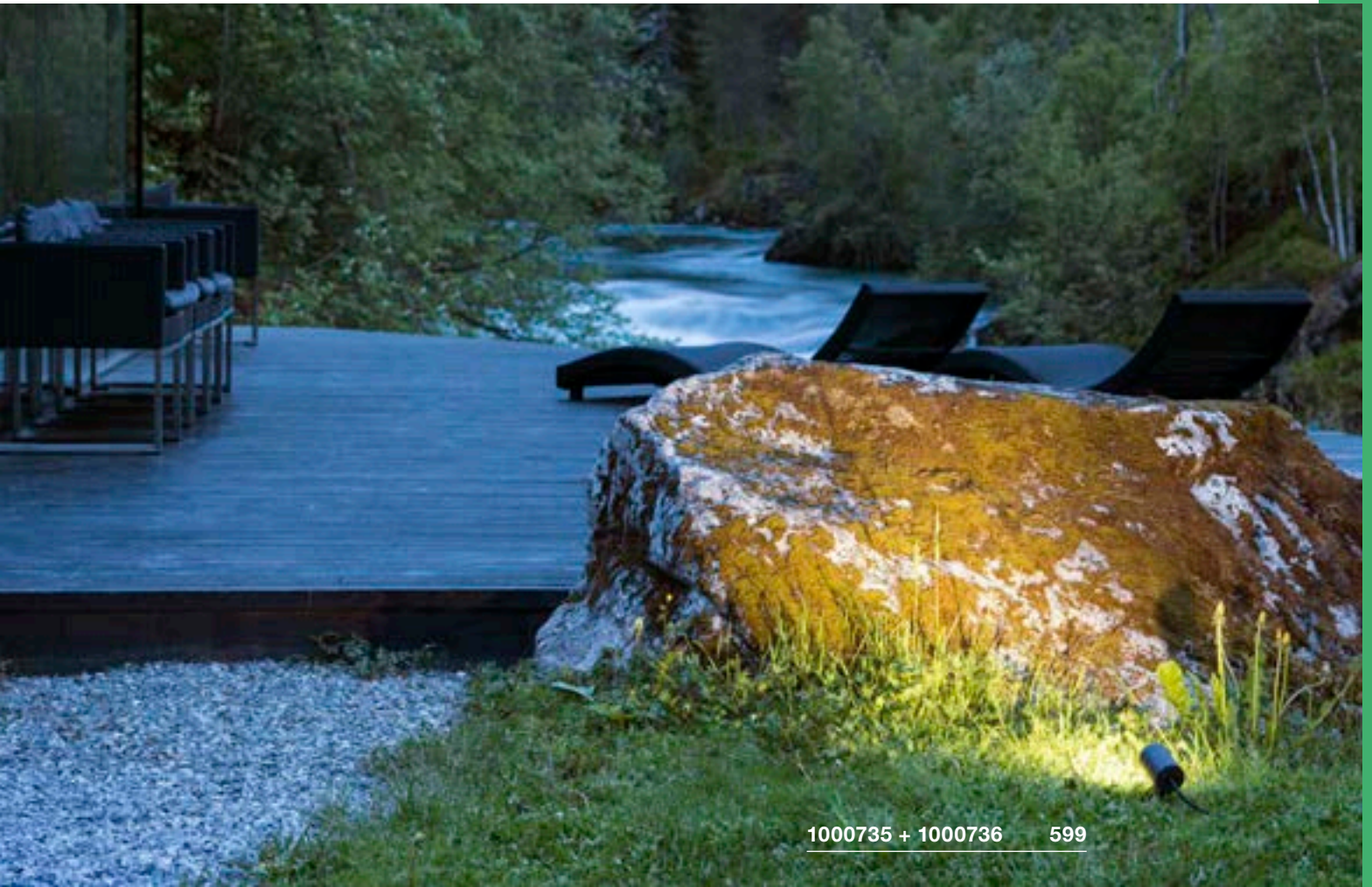

1000735 + 1000736 599

SPOT

							
588	588	589	589	590	590	591	591
							
593	593	595	597	597	597	598	598
							
599	599	600	601	603	603	603	604
							
604	605	605	606	606	607	607	608
							
609	609						

 Other luminaires and variants can be found online at www.slv.com

NAUTILUS 10
SP, round, QPAR51



E-A++ Range A++-E



BIG NAUTILUS
SP, round, QPAR51



B-A++ Range A++-E



Product details

230V ~50Hz
Material: Aluminium

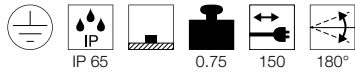

Product details

230V ~50Hz
Material: Aluminium



Dimensioned drawing

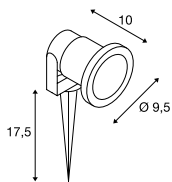

Dimensioned drawing

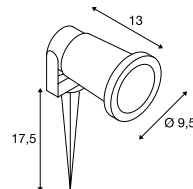

Note

IP 2-pin mains plug
Earth spike incl.

Note

IP 2-pin mains plug
Earth spike incl.

Recommended lamp

LED GU10 5.5W 38°
2700K 400lm EEL=A+
6kWh/1000h
Item no. 1001030



Recommended lamp

LED GU10 5.5W 38°
2700K 400lm EEL=A+
6kWh/1000h
Item no. 1001030



LED GU10 5.1W 48°
2700-6500K 350lm EEL==A+
6kWh/1000h
Item no. 1001918



LED GU10 5.1W 48°
2700-6500K 350lm EEL==A+
6kWh/1000h
Item no. 1001918



Lamp details

max. 35W QPAR51
L: 5.7 cm max.

Lamp details

max. 11W QPAR51
Ø: 5 cm max. L: 8.3 cm max.

Variant	Item no.
GU10 QPAR51	
■ grey	227418

Variant	Item no.
GU10 LED GU10 51mm	
■ black	227410
■ rust	1001964
■ green	1001965

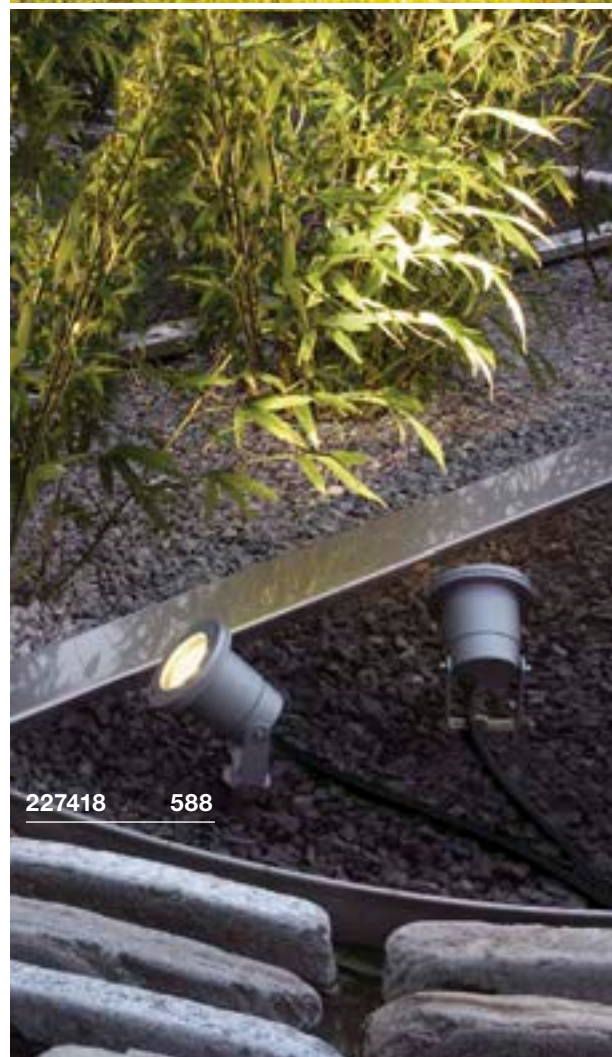

227418 588



231035 589

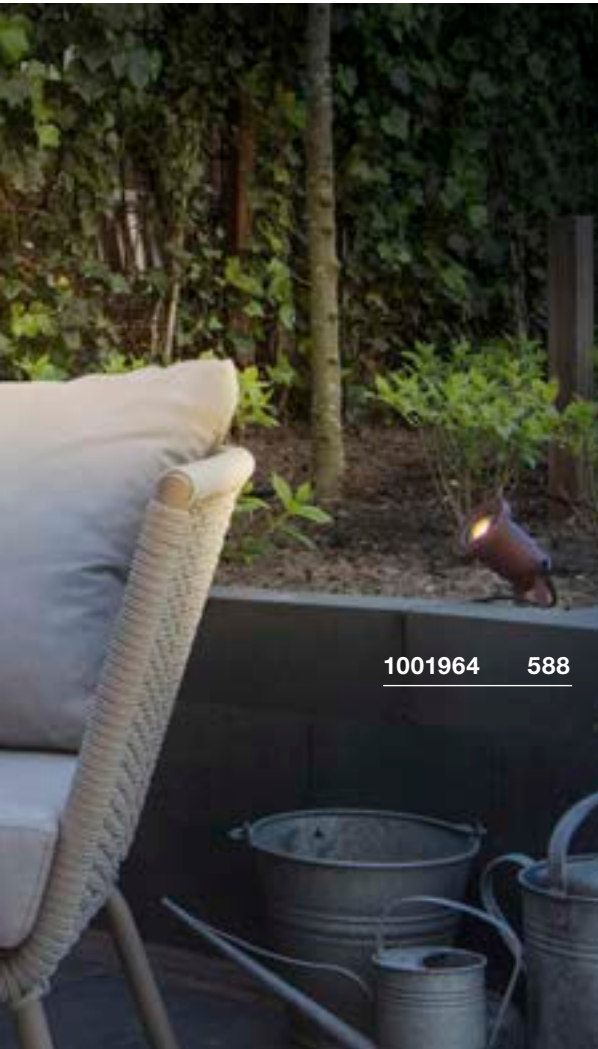

1001964 588

NAUTILUS 10
SP, round, QPAR51



E-A++ Range A++-E



- Stainless steel 316

Product details

230V ~50Hz
Material: Stainless Steel 316



Dimensioned drawing

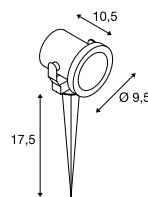

Note

IP 2-pin mains plug
Earth spike incl.

Recommended lamp

GU10 4.3W 40°
3000K 245lm EEL=A+
5kWh/1000h
Item no. 551253



LED GU10 5.6W 60°
2200-6700K 350lm EEL=A+
6kWh/1000h
Item no. 1001919



Lamp details

max. 25W QPAR51
Ø: 5 cm max. L: 5.7 cm max.

Variant	Item no.
GU10 QPAR51	
■ matt stainless steel	229740

NAUTILUS 10
SP, square



A-A++ Range A++-E



- Ideal for targeted accentuation of objects and areas

Product details

100-240V ~50/60Hz | 700mA
Total consumption: 8.5W
Material: Aluminium / Glass

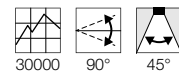

Dimensioned drawing

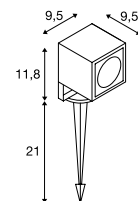

Note

IP 2-pin mains plug
Earth spike incl.

Variant	Item no.
620lm 3000K CRI>80	
■ anthracite	231035
620lm 3000K CRI>80	
■ rust	1001937
620lm 3000K CRI>80	
■ green	1001938

LED SPIKE
SP



LED
INSIDE



- Ideal for targeted accentuation of objects and areas

Product details

100-240V ~50/60Hz | 240mA
Total consumption: 6W
Material: Aluminium / Glass

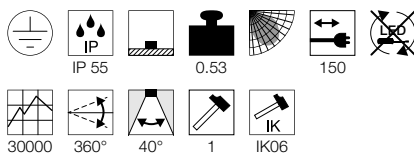

Dimensioned drawing

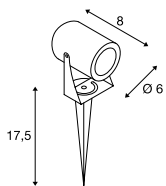

Note

IP 2-pin mains plug
Earth spike incl.

SYNA
SP



LED
INSIDE

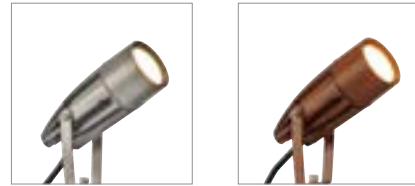

- 240V LED

Product details

220-240V ~50/60Hz
Total consumption: 8.6W
Material: Aluminium / Glass

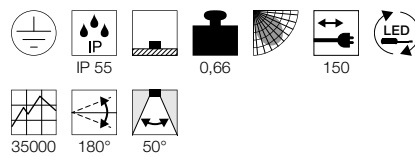

Dimensioned drawing

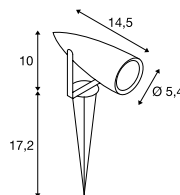

Note

IP 2-pin mains plug
Earth spike incl.



1002201 590



227507 590

Variant	Item no.
400lm 3000K CRI>80 ■ anthracite	1002201
400lm 3000K CRI>80 ■ green	1002202
400lm 3000K CRI>80 ■ rust	1002203

Variant	Item no.
470lm 3000K CRI>80 ■ grey / transparent	227504
470lm 3000K CRI>80 ■ anthracite	227505
470lm 3000K CRI>80 ■ rust	227507
470lm 3000K CRI>80 ■ green	227508



231535 591



231535 591

SITRA 360 SPIKE
SP, single, TCR-TSE



B-A++ Range A++-E



Product details

230V ~50Hz
Material: Aluminium / Glass



Dimensioned drawing

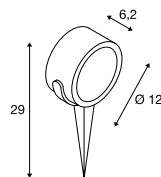

Note

IP 2-pin mains plug
Earth spike incl.

Recommended lamp

GX53 3W 120°
3000K 250lm EEL=A++
3kWh/1000h
Item no. 551372

LED GX53 8.2W 120°
4000K 620lm EEL=A+
9kWh/1000h
Item no. 550074

Lamp details

max. 9W TCR-TSE
Ø: 7.5 cm max. L: 3.5 cm max.

Variant	Item no.
GX53 TCR-TSE ■ anthracite	231525

SITRA 360 SPIKE
SP, double, TCR-TSE



B-A++ Range A++-E



Product details

230V ~50Hz
Material: Aluminium / Glass



Dimensioned drawing

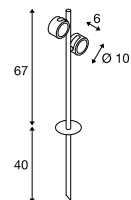

Note

IP 2-pin mains plug
Earth spike incl.

Recommended lamp

GX53 3W 120°
3000K 250lm EEL=A++
3kWh/1000h
Item no. 551372

LED GX53 8.2W 120°
4000K 620lm EEL=A+
9kWh/1000h
Item no. 550074

Lamp details

2x max. 9W TCR-TSE
Ø: 7.5 cm max. L: 3.5 cm max.

Variant	Item no.
GX53 TCR-TSE ■ anthracite	231535



231682 593



CV SPOT
SP, short

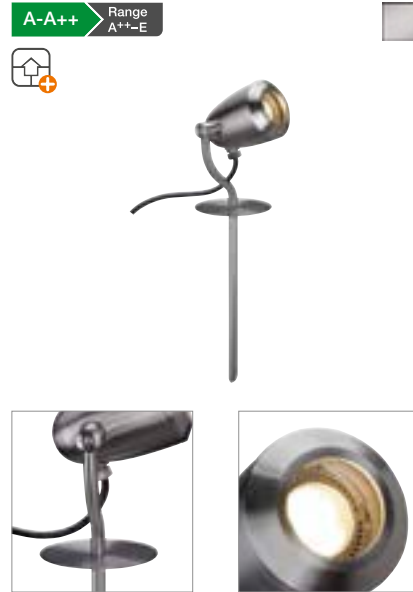

- Stainless steel 304

Product details

230V ~50Hz
Material: Stainless Steel 304



Dimensioned drawing

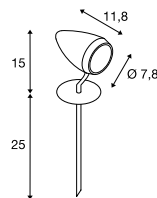

Note

IP 2-pin mains plug
Earth spike incl.

Recommended lamp

LED GU10 3.7W 36°
2700K 260lm EEL=A+
4kWh/1000h
Item no. 560122



Lamp details

max. 4W LED GU10 51mm
Ø: 5 cm max. L: 5.7 cm max.

Variant	Item no.
GU10 LED GU10 51mm ■ matt stainless steel	231672

CV SPOT
SP, long



- Stainless steel 304

Product details

230V ~50Hz
Material: Stainless Steel 304



Dimensioned drawing

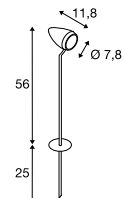

Note

IP 2-pin mains plug
Earth spike incl.

Recommended lamp

LED GU10 3.7W 36°
2700K 260lm EEL=A+
4kWh/1000h
Item no. 560122



Lamp details

max. 4W LED GU10 51mm
Ø: 5 cm max. L: 5.7 cm max.

Variant	Item no.
GU10 LED GU10 51mm ■ matt stainless steel	231682



229090 595

**NAUTILUS
SP, QR-C51** 892C-A+  Range
A++-E

- Stainless steel 304

Product details

12V ~50Hz

Material: Stainless Steel 304 / Glass



IP 67



1



150

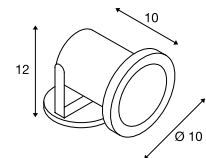

180°

Dimensioned drawing**Recommended accessories**

- Transformer 12V AC | 60VA IP44
Item no. 227160

**Recommended lamp**

GU5.3 3.8W 40°
2700K 245lm EEL=A+
5kWh/1000h
Item no. 551242



LED GU5.3 3.8W 40°
3000K 245lm EEL=A+
5kWh/1000h
Item no. 551243

**Lamp details**

max. 35W QR-C51

Variant	Item no.
GX5.3 QR-C51 ■ stainless steel	229090



229741 597

NAUTILUS 10 SPOT SP, QPAR51 

E-A++ Range A++-E



• Stainless steel 316

Product details

230V ~50Hz
Material: Stainless Steel 316

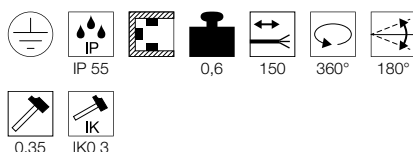

Dimensioned drawing

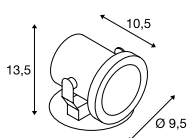

Note

Suitable plugs and other accessories can be found in our accessories chapter. Open cable end

Recommended accessories

■ IP68 connection box, 3-pole
Item no. 228730 

Recommended lamp

GU10 4.3W 40°
3000K 245lm EEL=A+
5kWh/1000h
Item no. 551253 

LED GU10 5.6W 60°
2200-6700K 350lm EEL=A+
6kWh/1000h
Item no. 1001919 

Lamp details

max. 25W QPAR51
Ø: 5 cm max. L: 6 cm max.

Variant	Item no.
■ stainless steel	229741

NAUTILUS SP 

A-A++ Range A++-E



• Stainless steel 316

Product details

220-240V ~50/60Hz
Total consumption: 9W
Material: Stainless Steel 316

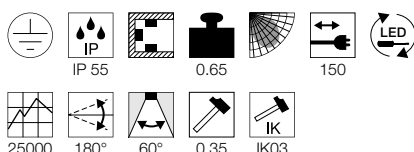

Dimensioned drawing

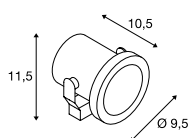

Note

IP 2-pin mains plug

Recommended accessories

■ Plate installation
Item no. 1001963 
■ Plastic earth spike
Item no. 900011 

NAUTILUS SPOT SP, PAR38, E27 

D-A+ Range A++-E

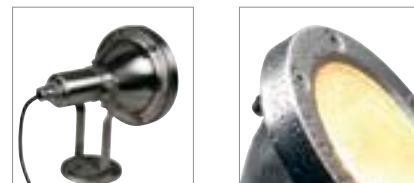

• Stainless steel 304

Product details

230V ~50Hz
Material: Stainless Steel 304

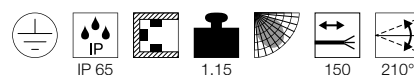

Dimensioned drawing

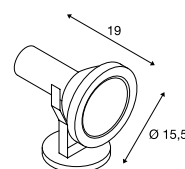

Note

Suitable plugs and other accessories can be found in our accessories chapter. Open cable end

Recommended accessories

■ IP68 connection box, 3-pole
Item no. 228730 

Recommended lamp

E27 17W 45°
3000K 1430lm EEL=A+
17kWh/1000h
Item no. 560473 

Lamp details

max. 80W PAR38
optional: QPAR30

Variant	Item no.
■ stainless steel	229100

DASAR® PROJECTOR
SP, 12/24V



Product details

12V/24V DC
Material: Stainless Steel 316 / Glass

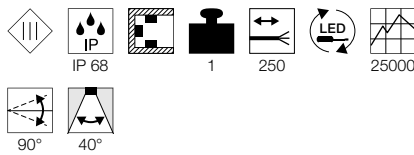

Dimensioned drawing

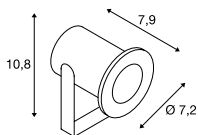

Note

Connection box 229269 provides enough room for the recommended power supply, see accessories chapter
Open cable end

Recommended accessories

- LED power supply 24V DC | 12W
Item no. 470502
- LED power supply, 12V DC | 12W
Item no. 470507
- Earth spike stainless steel 316
Item no. 233580
- Installation plate stainless steel 316
Item no. 233582
- Plastic earth spike
Item no. 900011

Variant	Item no.
360lm 3000K CRI>80 <input checked="" type="checkbox"/> stainless steel	233570

DASAR® PROJECTOR
SP, 230V

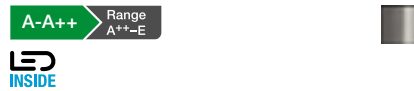

Product details

220-240V ~50/60Hz | 400mA
Total consumption: 5.5W
Material: Stainless Steel 316 / Glass

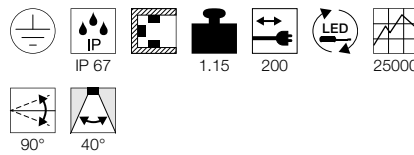

Dimensioned drawing

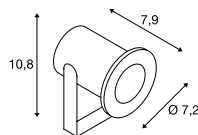

Note

IP 2-pin mains plug

Recommended accessories

- Earth spike stainless steel 316
Item no. 233580
- Installation plate stainless steel 316
Item no. 233582
- Plastic earth spike
Item no. 900011

Variant	Item no.
300lm 3000K CRI>80 <input checked="" type="checkbox"/> stainless steel	233571

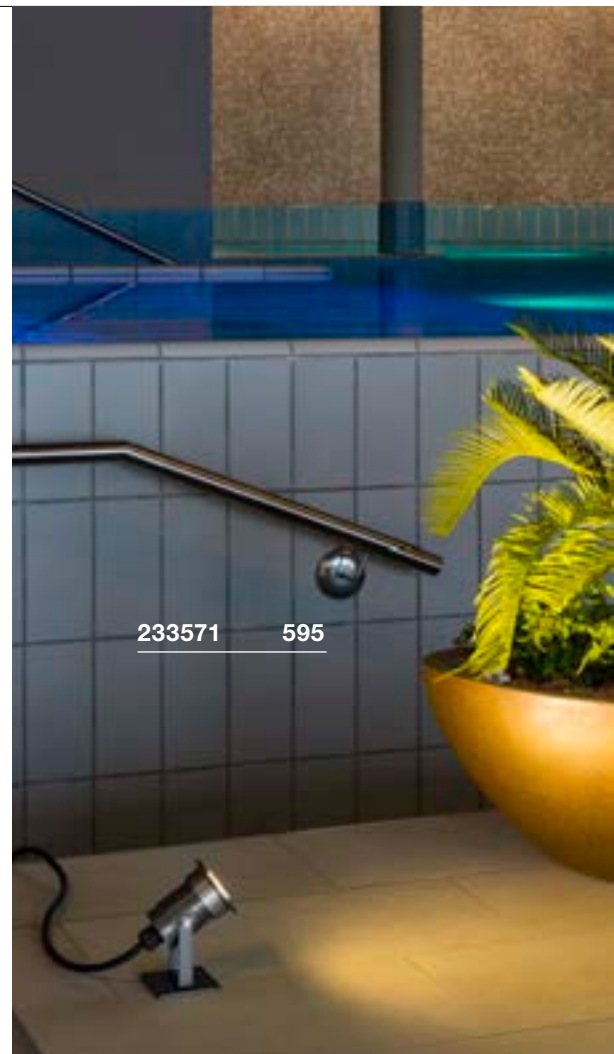



1000735 599



1000735 599

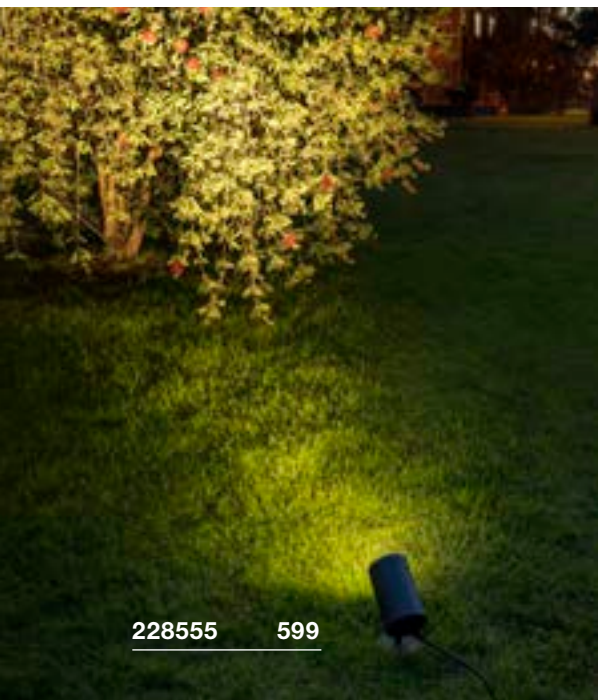

228555 599

HELIA SPOT S
SP, single, TRIAC



A-A++ Range A++-E



Product details

220-240V ~50/60Hz
Total consumption: 8W
Material: Aluminium
Dimmable: Triac C, Triac L

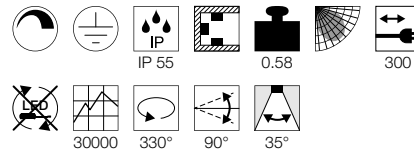

Dimensioned drawing

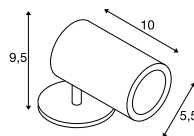

Note

IP 2-pin mains plug

Recommended accessories

■ Earth spike
Item no. 1000736

Variant	Item no.
480lm 3000K CRI>80 ■ anthracite	1000735

HELIA SPOT L
SP, single, TRIAC



A-A++ Range A++-E



• 240V LED

Product details

220-240V ~50/60Hz
Total consumption: 17W
Material: Aluminium / Glass
Dimmable: Triac C, Triac L

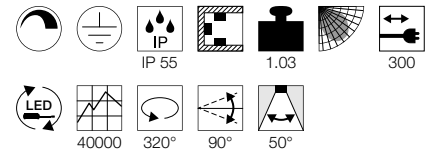

Dimensioned drawing

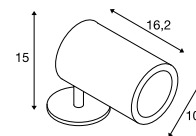

Note

IP 2-pin mains plug

Recommended accessories

■ Earth spike
Item no. 228560

Variant	Item no.
1050lm 3000K CRI>80 ■ anthracite	228555

SPOODI 15
SP

A-A++ Range
A++-E



Product details

230V ~50Hz
Total consumption: 10W
Material: Aluminium / Glass

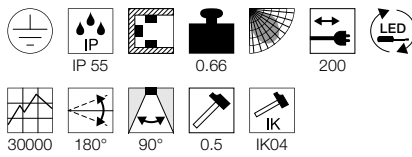

Dimensioned drawing

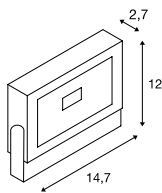

Note

IP 2-pin mains plug

Recommended accessories

- Plastic earth spike
Item no. 900011
- Wall bracket 50 cm
Item no. 234340
- Wall bracket 80 cm
Item no. 234350

Variant	Item no.
760lm 3000K CRI>80 ■ black	232800
830lm 4000K CRI>80 ■ black	232810



232800 600



232820 601

SPOODI 20 SP

A-A++ Range A++-E

LED INSIDE



Product details

230V ~50Hz
 Total consumption: 30W
 Material: Aluminium / Glass

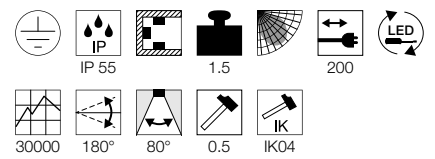

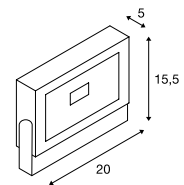

Dimensioned drawing



Note

IP 2-pin mains plug

Recommended accessories

- Plastic earth spike
 Item no. 900011 
- Wall bracket 50 cm
 Item no. 234340 
- Wall bracket 80 cm
 Item no. 234350 

Variant	Item no.
2365lm 3000K CRI>80	
■ black	232820
2680lm 4000K CRI>80	
■ black	232830



232850 603

LOUNGE
VVCCID

SPOODI 31 SP

A-A++ Range A++-E

LED INSIDE



Product details

230V ~50Hz
Total consumption: 60W
Material: Aluminium / Glass

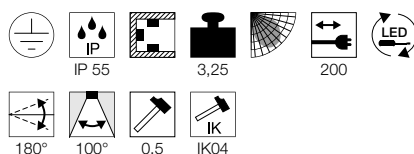

Dimensioned drawing

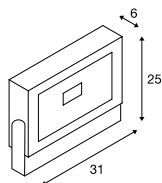

Note

IP 2-pin mains plug

Recommended accessories

- Wall bracket 50cm
Item no. 234340
- Wall bracket 80cm
Item no. 234350

Variant	Item no.
5100lm 3000K CRI>80 ■ black	232840
5500lm 4000K CRI>80 ■ black	232850

SPOODI 13 SP, SENSOR

A-A++ Range A++-E

LED INSIDE



Product details

220-240V ~50/60Hz
Total consumption: 11W
Material: Aluminium / Glass

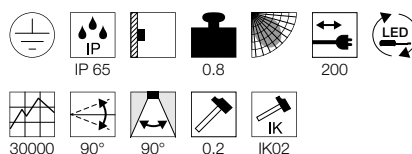

Dimensioned drawing

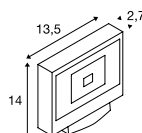

Note

Detection angle 110°, max. detection distance 8m, day/night mode, adjustable activation time
IP 2-pin mains plug
Remote control incl.

Variant	Item no.
800lm 3000K CRI>80 ■ black	232860
800lm 3000K CRI>80 ■ grey / transparent	232864
870lm 4000K CRI>80 ■ black	232870
870lm 4000K CRI>80 ■ grey / transparent	232874

SPOODI 20 SP, SENSOR

A-A++ Range A++-E

LED INSIDE



Product details

220-240V ~50/60Hz
Total consumption: 30W
Material: Aluminium / Glass

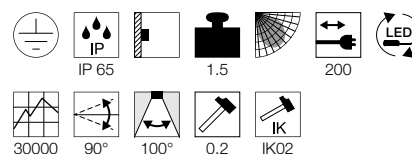

Dimensioned drawing

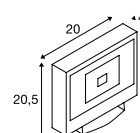

Note

Detection angle 110°, max. detection distance 8m, day/night mode, adjustable activation time
IP 2-pin mains plug
Remote control incl.

Variant	Item no.
2250lm 3000K CRI>80 ■ black	232880
2250lm 3000K CRI>80 ■ grey / transparent	232884
2500lm 4000K CRI>80 ■ black	232890
2500lm 4000K CRI>80 ■ grey / transparent	232894

OUTDOOR BEAM 11
SP

A-A++ Range A++-E

LED INSIDE

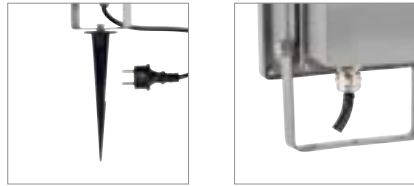

OUTDOOR BEAM 22
SP

A-A++ Range A++-E

LED INSIDE



Product details

220-240V ~50/60Hz | 120mA
Total consumption: 11W
Material: Aluminium / Glass

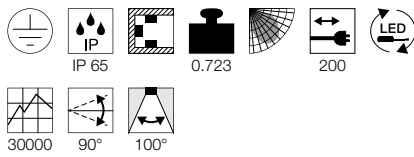

Dimensioned drawing

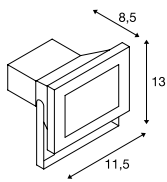

Note

IP 2-pin mains plug

Recommended accessories

- Plastic earth spike
Item no. 900011
- Wall bracket 50 cm
Item no. 234344
- Wall bracket 80 cm
Item no. 234354

Variant	Item no.
800lm 5700K CRI>80 ■ grey / transparent	1001633
725lm 3000K CRI>80 ■ grey / transparent	1001634

Product details

220-240V ~50/60Hz | 760mA
Total consumption: 32W
Material: Aluminium / Glass

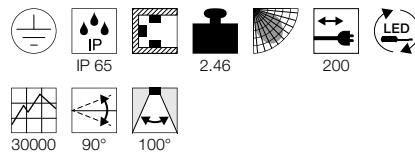

Dimensioned drawing

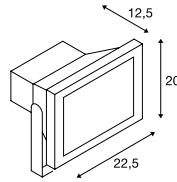

Note

IP 2-pin mains plug

Recommended accessories

- Plastic earth spike
Item no. 900011
- Wall bracket 50 cm
Item no. 234344
- Wall bracket 80 cm
Item no. 234354

Variant	Item no.
2900lm 5700K CRI>80 ■ grey / transparent	1001635
2900lm 3000K CRI>80 ■ grey / transparent	1001636



1001634 604

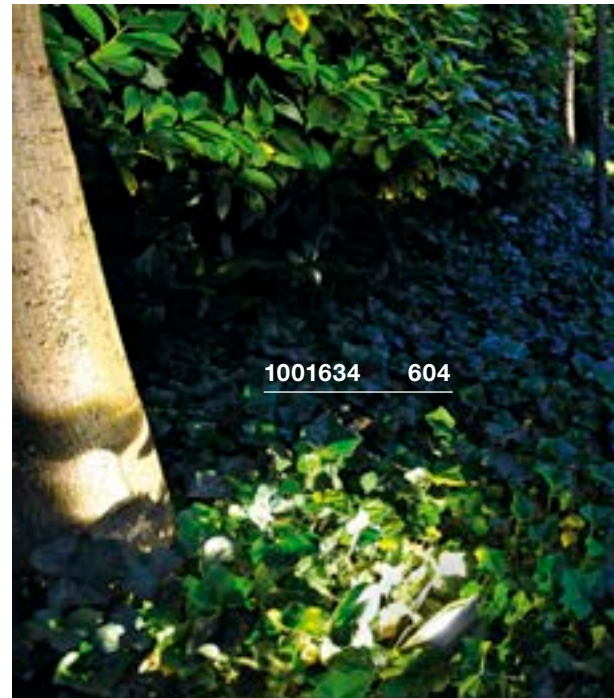

1001634 604



1001636 604



OUTDOOR BEAM 28 SP

A-A++ Range A++-E
LED INSIDE



Product details

220-240V ~50/60Hz | 640mA
 Total consumption: 54W
 Material: Aluminium / Glass

30000 90° 100°

Dimensioned drawing

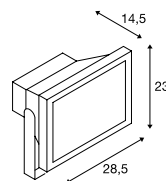

Note

IP 2-pin mains plug

Recommended accessories

- Wall bracket 50 cm
Item no. 234344
- Wall bracket 80 cm
Item no. 234354

Variant	Item no.
5100lm 5700K CRI>80 ■ grey / transparent	1001637
5100lm 3000K CRI>80 ■ grey / transparent	1001638

231072 605

FLAC BEAM® SP

A-A++ Range A++-E
LED INSIDE



Product details

220-240V ~50/60Hz
 Material: Aluminium

30000 120° 170° 60° 0,5 IK04

Dimensioned drawing

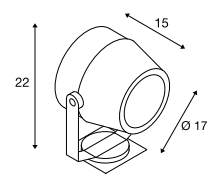

Note

IP 2-pin mains plug

Variant	Item no.
1250lm 3000K CRI>80 18W ■ grey	231092
1800lm 3000K CRI>80 27W ■ grey	231072

FLOOD LIGHT 25 SP

A-A++ Range A+-E



FLOOD LIGHT 32 SP

A-A++ Range A+-E



Product details

220-240V ~50/60Hz | 760mA
Total consumption: 32W
Material: Aluminium / Glass

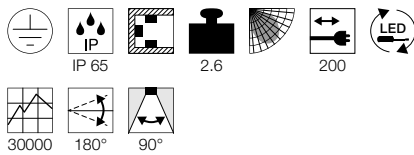

Dimensioned drawing

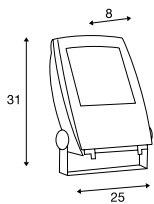

Note

IP 2-pin mains plug

Product details

220-240V ~50/60Hz | 1150mA
Total consumption: 81W
Material: Aluminium / Glass

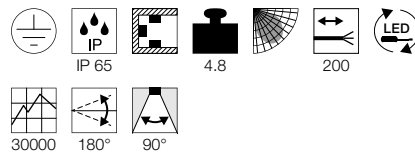

Dimensioned drawing

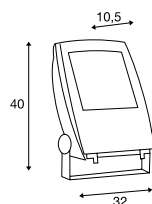

Note

Open cable end

Recommended accessories

- Plastic earth spike
Item no. 900011
- Wall bracket 50 cm
Item no. 234340
- Wall bracket 80 cm
Item no. 234350

Recommended accessories

- Wall bracket 50 cm
Item no. 234340
- Wall bracket 80 cm
Item no. 234350
- IP68 connection box, 3-pole
Item no. 228730

Variant	Item no.
2350lm 5700K CRI>80 ■ matt black	1001642
2200lm 3000K CRI>80 ■ matt black	1001643

Variant	Item no.
7200lm 5700K CRI>80 ■ matt black	1001644
6300lm 3000K CRI>80 ■ matt black	1001645





234205 607



234215 607

WILRON S
SP

A-A++ Range A++-E



Product details

100-277V ~50/60Hz | 500mA
Total consumption: 20W
Material: Aluminium / Glass

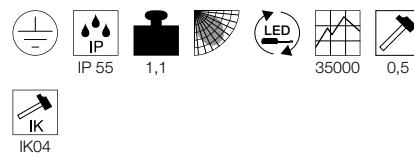

Dimensioned drawing

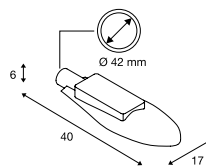

Note

A wall bracket [234225] is needed for installation.
A wall bracket [234245] is needed for installation in facade corners.
The lamp is suitable for a connecting piece with a diameter of 40mm.

Recommended accessories

- Wall bracket
Item no. 234225
- Corner wall bracket
Item no. 234245

Variant	Item no.
2010lm 4000K CRI>80 ■ anthracite	234205

WILRON L
SP

A-A++ Range A++-E

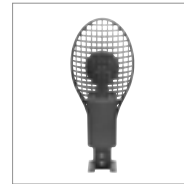

Product details

220-240V ~50/60Hz | 1500mA
Total consumption: 65W
Material: Aluminium / Glass

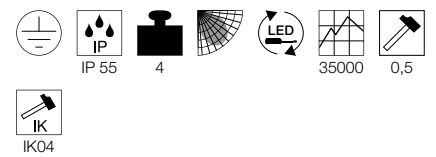

Dimensioned drawing

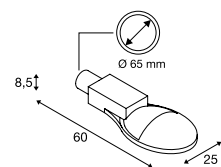

Note

A wall bracket [234235] is needed for installation.
A wall bracket [234255] is needed for installation in facade corners.
The lamp is suitable for a connecting piece with a diameter of 60mm.

Recommended accessories

- Wall bracket
Item no. 234235
- Corner connector
Item no. 234255

Variant	Item no.
5900lm 4000K CRI>80 ■ anthracite	234215

VANO WING
SP, 1-10V

A-A++ Range A++-E



- Asymmetric light distribution
- Homogeneous illumination of vertical surfaces

Product details

120-277V ~50/60Hz | 525mA
Material: Aluminium / Glass
Dimmable: 1-10V

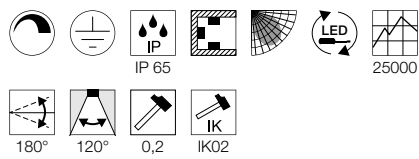

Dimensioned drawing

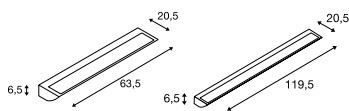

Variant	Item no.
1500lm 3000K CRI>80 35W B: 63.5 cm 3.29 kg grey / transparent	227734
3340lm 3000K CRI>80 48W B: 119.5 cm 6 kg grey / transparent	227744



227734 608



227744 608



229482 609



229482 609

GALEN SP, TRIAC

A-A++ Range A++-E

LED INSIDE



- 240V LED
- IP plug connector

Product details

220-240V ~50/60Hz
 Total consumption: 18W
 Material: Aluminium / Glass
 Dimmable: Triac C, Triac L

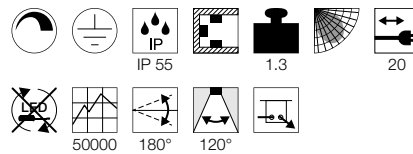

Dimensioned drawing

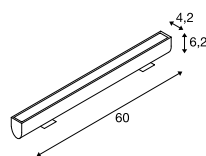

Recommended accessories

- Connection lead 500 cm
Item no. 231960
- Connection cable 100 cm
Item no. 231961



Variant	Item no.
850lm 3000K CRI>80	
■ grey / matt transparent	231954
850lm 3000K CRI>80	
■ anthracite	231955

GALEN 100 SP

A-A++ Range A++-E

LED INSIDE



Product details

24V DC
 Total consumption: 25W
 Material: Aluminium / Glass

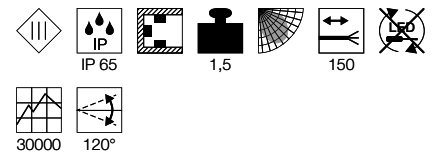

Dimensioned drawing

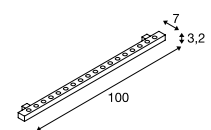

Note

Open cable end

Recommended accessories

- LED power supply 24V DC | 36W
Item no. 470544
- LED power supply 24V DC | 60W
Item no. 470506



Variant	Item no.
1070lm 6500K CRI>70	
■ grey / transparent	229481
970lm 3000K CRI>70	
■ grey / transparent	229482

BRINGING LIGHT INTO THE DARK.

PRACTICAL WALL AND CEILING LIGHTS.

They beam out, even under the worst weather conditions: Our wall and ceiling lights are robust, energy-efficient and powerful. However, as well as all of the functionality you can also choose between different designs. Do you prefer modern? Traditional? Round? Or would you like square?



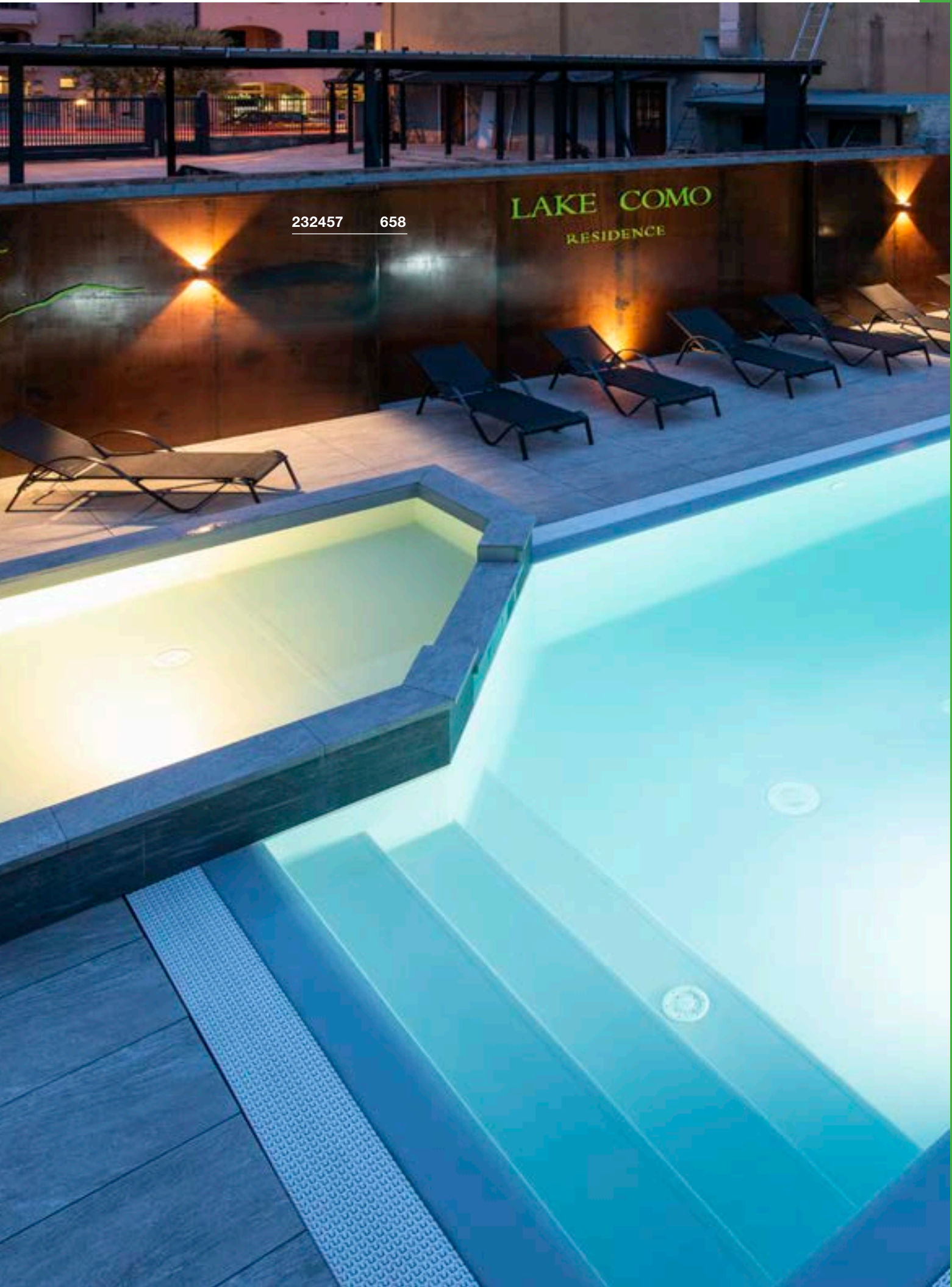

















































































232457 658



1002900 660

WALL AND CEILING LIGHTS

							
614	614	614	616	617	618	618	619
							
619	620	620	620	622	623	624	625
							
626	627	627	628	629	629	629	630
							
631	632	632	633	633	634	635	636
							
637	637	638	639	639	639	640	640
							
641	641	641	642	643	643	644	644

 645	 645	 646	 646	 647	 648	 649	 649
 650	 650	 651	 652	 653	 653	 654	 654
 654	 655	 655	 656	 656	 657	 657	 658
 658	 659	 660	 661	 661	 662	 663	 663
 664	 665	 665	 666	 666	 668	 668	 669
 670	 670	 670	 671	 671	 672	 672	 673
 674	 675	 675	 675	 676	 676	 676	 677
 677	 678	 678	 678	 679	 680	 680	 681
 681	 682	 682	 683	 684	 684	 684	 687
 687	 687	 688	 689	 689	 689	 690	 690
 690	 691	 691					

 Other luminaires and variants can be found online at www.slv.com

PHOTONIA
WL, E27



E-A++ Range A++-E



GLOO PURE
WL, E27



E-A++ Range A++-E



MOLAT
WL, E27



E-A++ Range A++-E

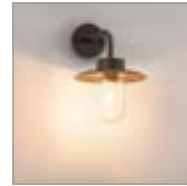

Product details

220-240V ~50/60Hz
Material: Aluminium / Glass



Product details

230V ~50Hz
Material: Aluminium / Glass

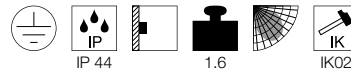

Product details

230V ~50/60Hz
Material: Aluminium / Glass



Dimensioned drawing

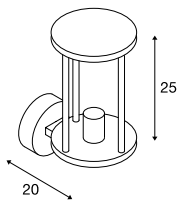

Dimensioned drawing

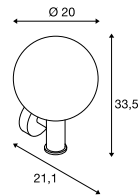

Dimensioned drawing

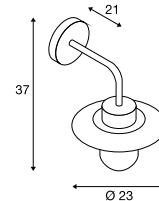

Recommended lamp

E27 5W 330°
2000K 500lm EEL=A+
5kWh/1000h
Item no. 560741



LED E27 7W 280°
2700K 790lm EEL=A++
7kWh/1000h
Item no. 1002127



Recommended lamp

E27 4.7W 360°
3000K 380lm EEL=A+
5kWh/1000h
Item no. 551532



LED E27 12W 240°
3000K 1055lm EEL=A+
12kWh/1000h
Item no. 1001032



Recommended lamp

LED E27 4.8W 330°
2700K 470lm EEL=A++
5kWh/1000h
Item no. 560752



LED E27 5W 330°
2000K 500lm EEL=A+
5kWh/1000h
Item no. 560741



Lamp details

max. 60W
Ø: 9 cm max. L: 15 cm max.

Lamp details

max. 23W
Ø: 4.8 cm max. L: 18 cm max.

Lamp details

max. 60W
Ø: 6.5 cm max. L: 14.5 cm max.

Variant	Item no.
E27	
■ anthracite	232045

Variant	Item no.
E27	
■ anthracite / matt transparent	1002002

Variant	Item no.
E27	
■ anthracite	1000820

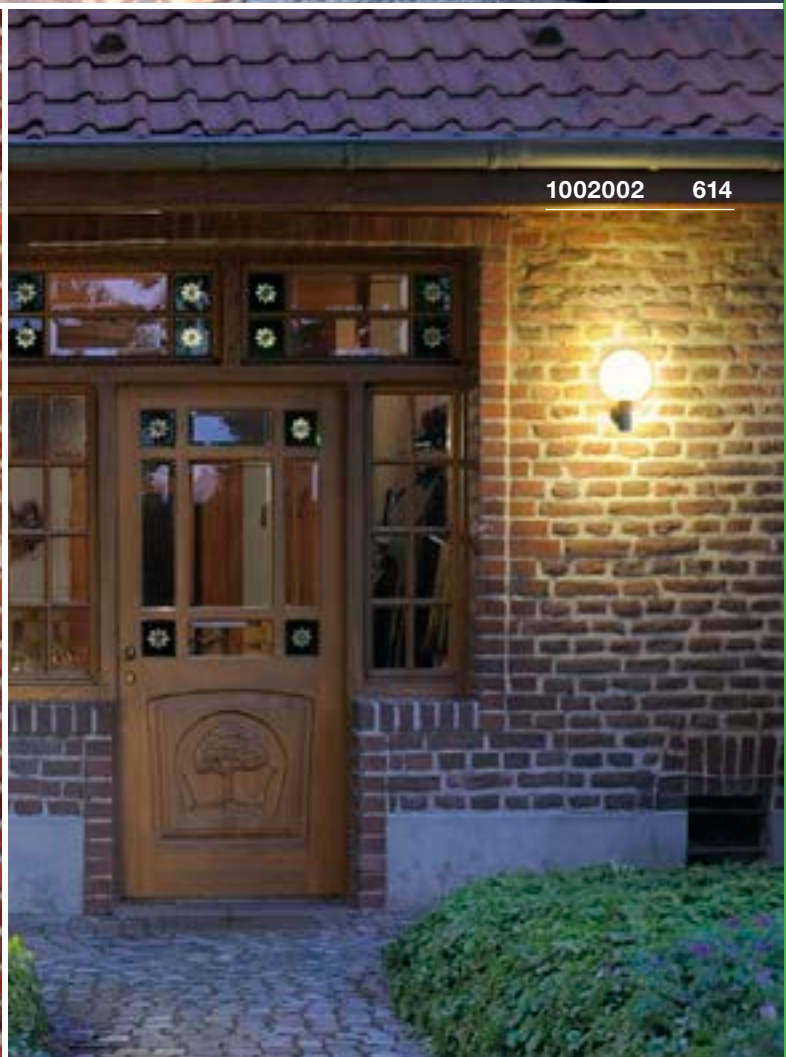
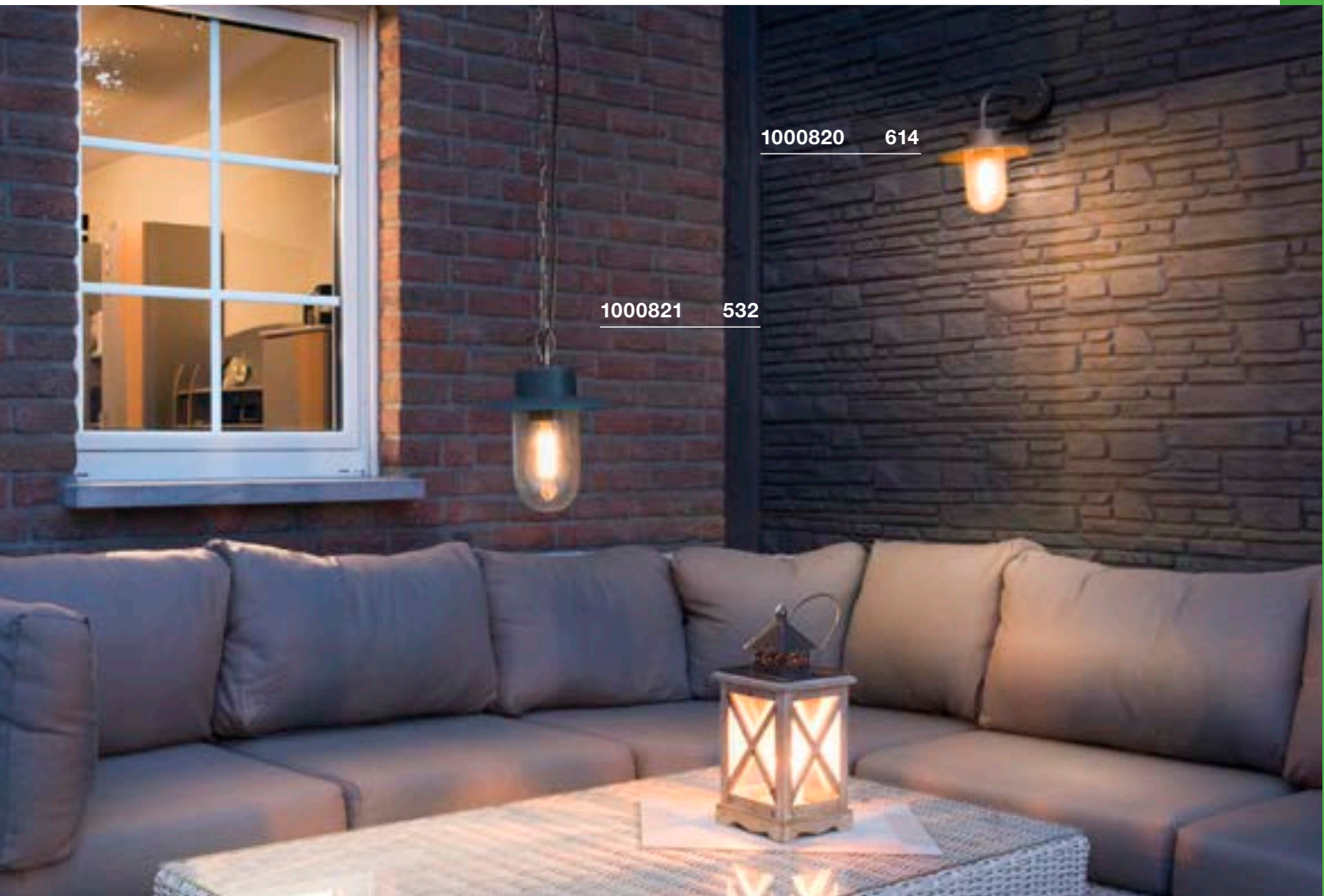

SLOTS
WL



A-A++ Range
A++-E



Product details

220-240V ~50/60Hz
Total consumption: 6.3W
Material: Aluminium / Glass

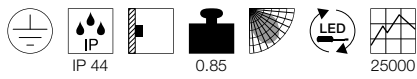

Dimensioned drawing

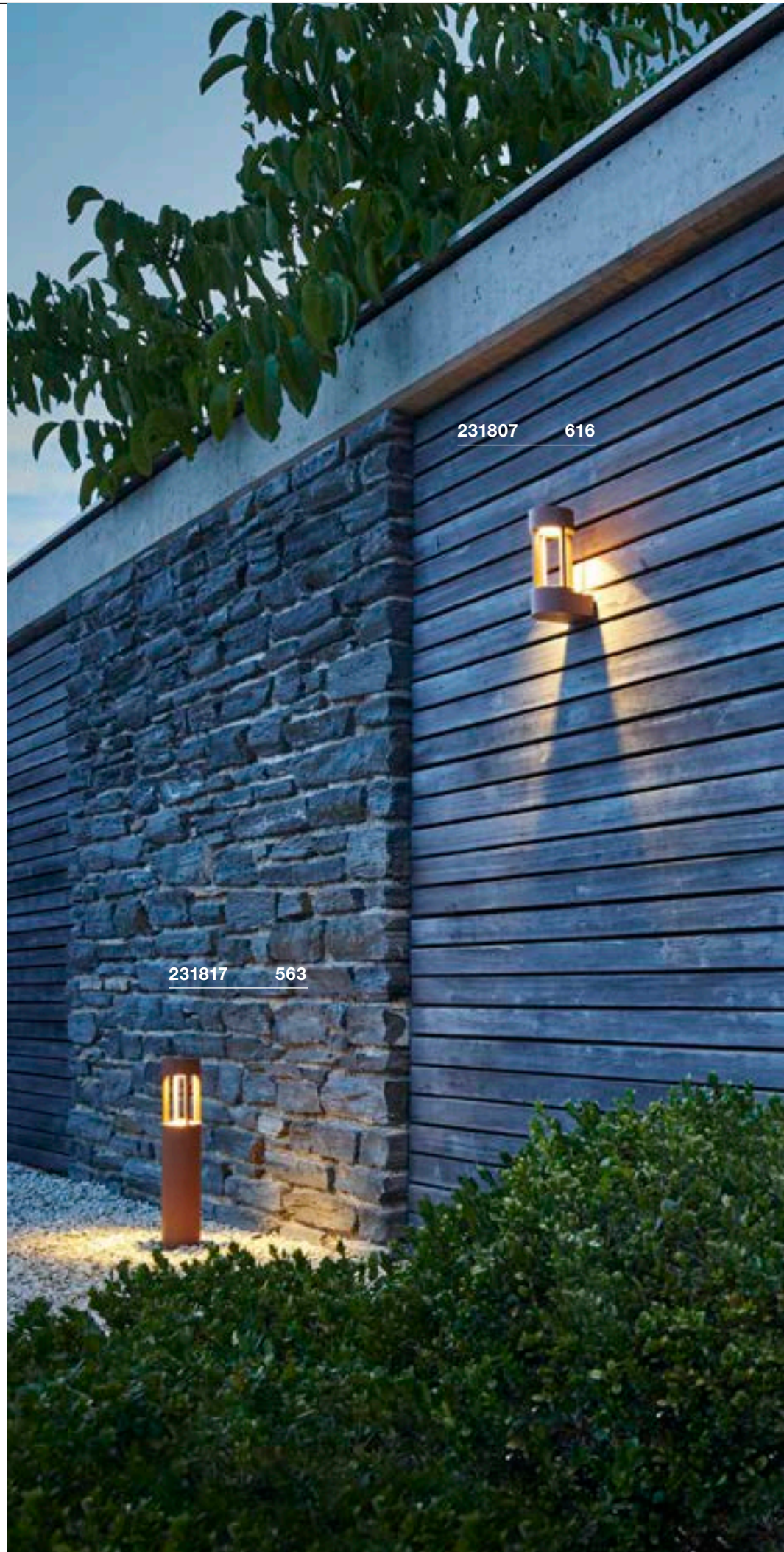
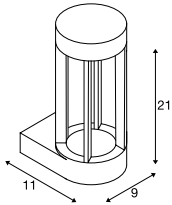

Variant	Item no.
140lm 3000K CRI>80	
■ anthracite	231805
140lm 3000K CRI>80	
■ rust	231807



1000681 617

1000682 549

APONI
WL, TRIAC

883

A-A++ Range A++-E

LED
INSIDE



• 240V LED

Product details

220-240V ~50/60Hz
Total consumption: 8W
Material: Aluminium
Dimmable: Triac L

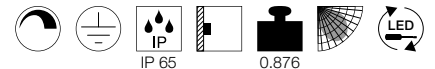

30000

Dimensioned drawing

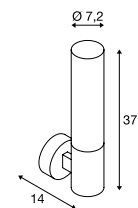

Variant	Item no.
440lm 3000K CRI>80 ■ anthracite	1000681

F-POL
WL, E27



C-POL
WL, E27



A-A++ Range
A++-E

A-A++ Range
A++-E



- Highly polished reflector for effective lighting
- Diffuse light distribution for illuminating the surroundings of the building

- Highly polished reflector for effective lighting
- Diffuse light distribution for illuminating the surroundings of the building

Product details

230V ~50Hz
Material: Aluminium / Polycarbonate (PC)

Product details

230V ~50Hz
Material: Aluminium / Polycarbonate (PC)

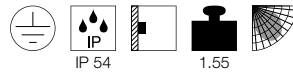
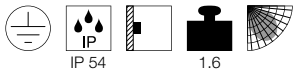

Dimensioned drawing

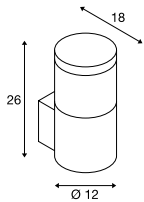

Dimensioned drawing

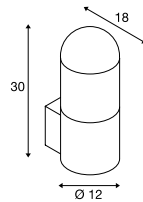

Recommended lamp

E27 12W 240°
3000K 1055lm EEL=A+
12kWh/1000h
Item no. 1001032



Recommended lamp

E27 15W 240°
3000K 1521lm EEL=A+
15kWh/1000h
Item no. 1001033



Lamp details

max. 20W
Ø: 5 cm max. L: 14 cm max.

Lamp details

max. 24W
Ø: 5.2 cm max. L: 17.3 cm max.

Variant	Item no.
E27	
■ anthracite	231585

Variant	Item no.
E27	
■ anthracite	231465



231585 618



231465 618



228120 + 1000449 619

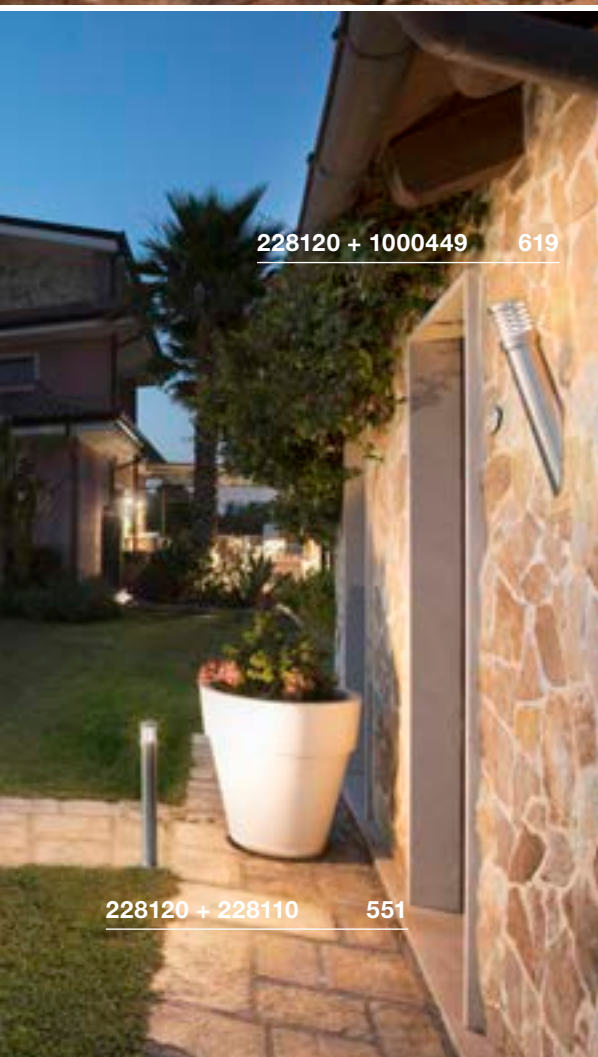

228120 + 1000449 619

228120 + 228110 551

TRUST
WL



A-A++ Range A++-E

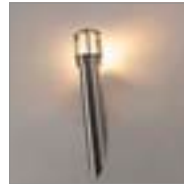

- 240V LED
- Stainless steel 316

Product details

220-240V ~50/60Hz
Total consumption: 8.6W
Material: Stainless Steel 316



Dimensioned drawing

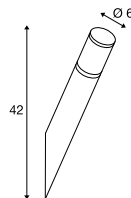

Recommended accessories

- IP68 connection box, 3-pole
Item no. 228730
- Grid, circular
Item no. 228130
- Grid, helical
Item no. 1000449

Variant	Item no.
400lm 3000K CRI>80	
■ Stainless steel	228120

BIG NAILS
WL, E27



A-A++ Range A++-E



- Stainless steel 304
- Sleek design, glare-free outdoor lighting

Product details

230V ~50Hz
Material: Stainless Steel 304 / Polycarbonate (PC)

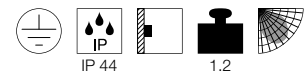

Dimensioned drawing

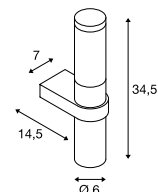

Recommended lamp

E27 4.7W 360°
3000K 380lm EEL=A+
5kWh/1000h
Item no. 551532



LED E27 12W 240°
3000K 1055lm EEL=A+
12kWh/1000h
Item no. 1001032



Lamp details

max. 15W
Ø: 4.5 cm max. L: 17 cm max.

Variant	Item no.
E27	
■ Stainless steel	229182

**GRAFIT
WL, E27**



A-A++ Range A++-E



**SQUARE
WL, E27**



A-A++ Range A++-E



**SQUARE
WL, TRIAC**



A-A++ Range A++-E



- Luminaire made from high-quality 316 stainless steel
- Modern design
- Diffuse light distribution for illuminating the surroundings of the building

Product details

230V ~50Hz
Material: Aluminium / Plastic

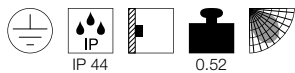

Product details

220-240V ~50/60Hz
Material: Stainless Steel 304



Product details

220-240V ~50/60Hz
Total consumption: 12W
Material: Stainless Steel 316
Dimmable: Triac C, Triac L

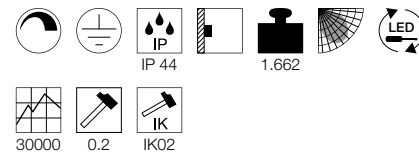

Dimensioned drawing

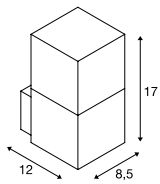

Dimensioned drawing

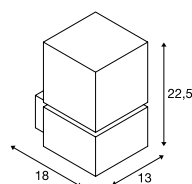

Dimensioned drawing

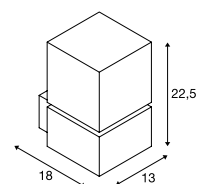

Recommended lamp

LED E27 7W 280°
2700K 790lm EEL=A++
7kWh/1000h
Item no. 1002127



LED E27 6.8W 330°
2700K 806lm EEL=A++
7kWh/1000h
Item no. 560762



Recommended lamp

LED E27 4.5W 280°
2700K 530lm EEL=A++
5kWh/1000h
Item no. 1002123



LED E27 7W 280°
2700K 790lm EEL=A++
7kWh/1000h
Item no. 1002124



Lamp details

max. 11W
Ø: 6 cm max. L: 11.5 cm max.

Lamp details

max. 20W
Ø: 7 cm max. L: 13 cm max.

Variant	Item no.
E27	
■ anthracite	231205

Variant	Item no.
E27	
■ Stainless steel	1000336

Variant	Item no.
760lm 3000K CRI>80	
■ Stainless steel	1000834



KERAS ELT
WL, E27A-A++ Range
A++-E

- Unusual design

Product details

230V ~50Hz
Material: Aluminium / Polycarbonate (PC)



IP 54



1.6



Dimensioned drawing

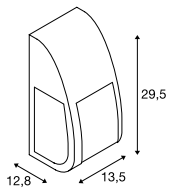

Recommended lamp

LED E27 14.5W 200°
2700K 1521lm EEL=A+
15kWh/1000h
Item no. 560422



LED E27 9W 240°
2700-6500K 806lm EEL=A+
9kWh/1000h
Item no. 1001916



Lamp details

max. 25W
Ø: 7 cm max. L: 17.5 cm max.

Variant	Item no.
E27	
■ grey	227174
E27	
■ anthracite	227176

227174 622



230445 623

MERIDIAN WL, E27

A-A++ Range
A++-E

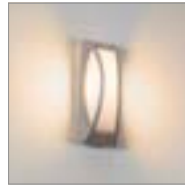

Product details

230V ~50Hz

Material: Aluminium / Polycarbonate (PC)



IP 54



1.25



Dimensioned drawing

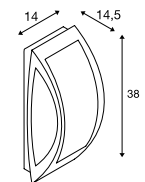

Recommended lamp

LED E27 9.1W 240°
2700K 760lm EEL=A+
10kWh/1000h

Item no. 560402



LED E27 9W 240°
2700-6500K 806lm EEL=A+
9kWh/1000h

Item no. 1001916



Lamp details

max. 25W

Ø: 7 cm max. L: 17.5 cm max.

Variant	Item no.
E27	
■ grey	230444
E27	
■ anthracite	230445

QUADRULO SENSOR WL, E27

E-A++ Range
A++-E

NEW



Product details

230V ~50Hz
Material: Aluminium / Glass

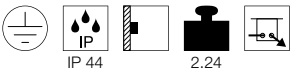

Dimensioned drawing

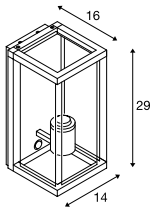

Recommended lamp

LED E27 4.5W 280°
2700K 530lm EEL=A++
5kWh/1000h
Item no. 1002123



LED E27 5W 330°
2000K 500lm EEL=A+
5kWh/1000h
Item no. 560741



Lamp details

max. 15W
Ø: 8 cm max. L: 18 cm max.

Variant	Item no.
E27	
■ anthracite	1002402



1002402 624



1002403 625

QUADRULO WL, E27

E-A++ Range
A++-E

NEW



Product details

230V ~50Hz
Material: Aluminium / Glass



IP 44



2.21

Dimensioned drawing

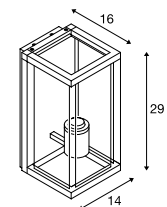

Recommended lamp

LED E27 4.5W 280°
2700K 530lm EEL=A++
5kWh/1000h
Item no. 1002123



LED E27 5W 330°
2000K 500lm EEL=A+
5kWh/1000h
Item no. 560741



Lamp details

max. 15W
Ø: 8 cm max. L: 18 cm max.

Variant	Item no.
E27 ■ anthracite	1002403

MERIDIAN BOX WL, E27

A-A++ Range
A++-E



Product details

230V ~50Hz

Material: Aluminium / Polycarbonate (PC)

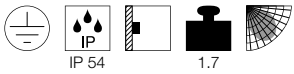

Dimensioned drawing

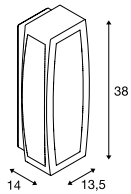

Recommended lamp

LED E27 7.1W 330°
2700K 806lm EEL=A+
8kWh/1000h

Item no. 1001756



LED E27 5W 330°
2000K 500lm EEL=A+
5kWh/1000h

Item no. 560741



Lamp details

max. 25W

Ø: 7 cm max. L: 17.5 cm max.

Variant	Item no.
E27	
■ anthracite	230655
E27	
■ rust	230657



230655

626

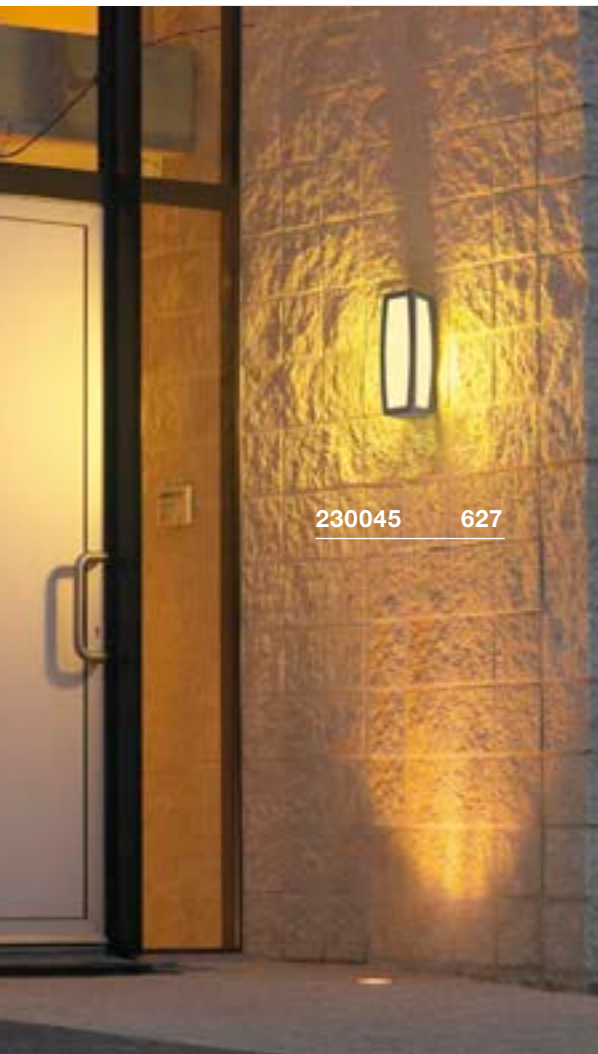

230045 627



230044 627

MERIDIAN BOX
WL, E27



Product details

230V ~50Hz
Material: Aluminium / Polycarbonate (PC)

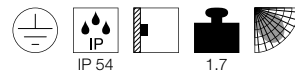

Dimensioned drawing

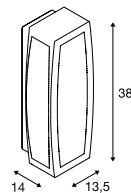

Recommended lamp

LED E27 7.1W 330°
2700K 806lm EEL=A+
8kWh/1000h
Item no. 1001756



LED E27 5W 330°
2000K 500lm EEL=A+
5kWh/1000h
Item no. 560741



Lamp details

max. 25W
Ø: 7 cm max. L: 17.5 cm max.

Variant	Item no.
E27	
■ grey	230044
E27	
■ anthracite	230045

MERIDIAN BOX
WL, E27, MR



Product details

230V ~50Hz
Material: Aluminium / Polycarbonate (PC)

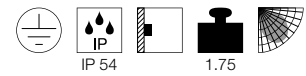

Dimensioned drawing

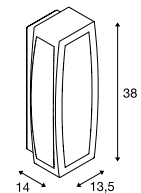

Note

Motion sensor: Detection angle: 180° detection distance: 1-5 m
The switch-on ambient brightness and switch-on delay can be adjusted.

Recommended lamp

E27 9W 240°
3000K 810lm EEL=A+
10kWh/1000h
Item no. 1001031



LED E27 12W 240°
3000K 1055lm EEL=A+
12kWh/1000h
Item no. 1001032



Lamp details

max. 25W
Ø: 7 cm max. L: 17.5 cm max.

Variant	Item no.
E27	
■ grey	230084
E27	
■ anthracite	230085

ENOLA C
WL



A-A++ Range
A++-E



228511 628

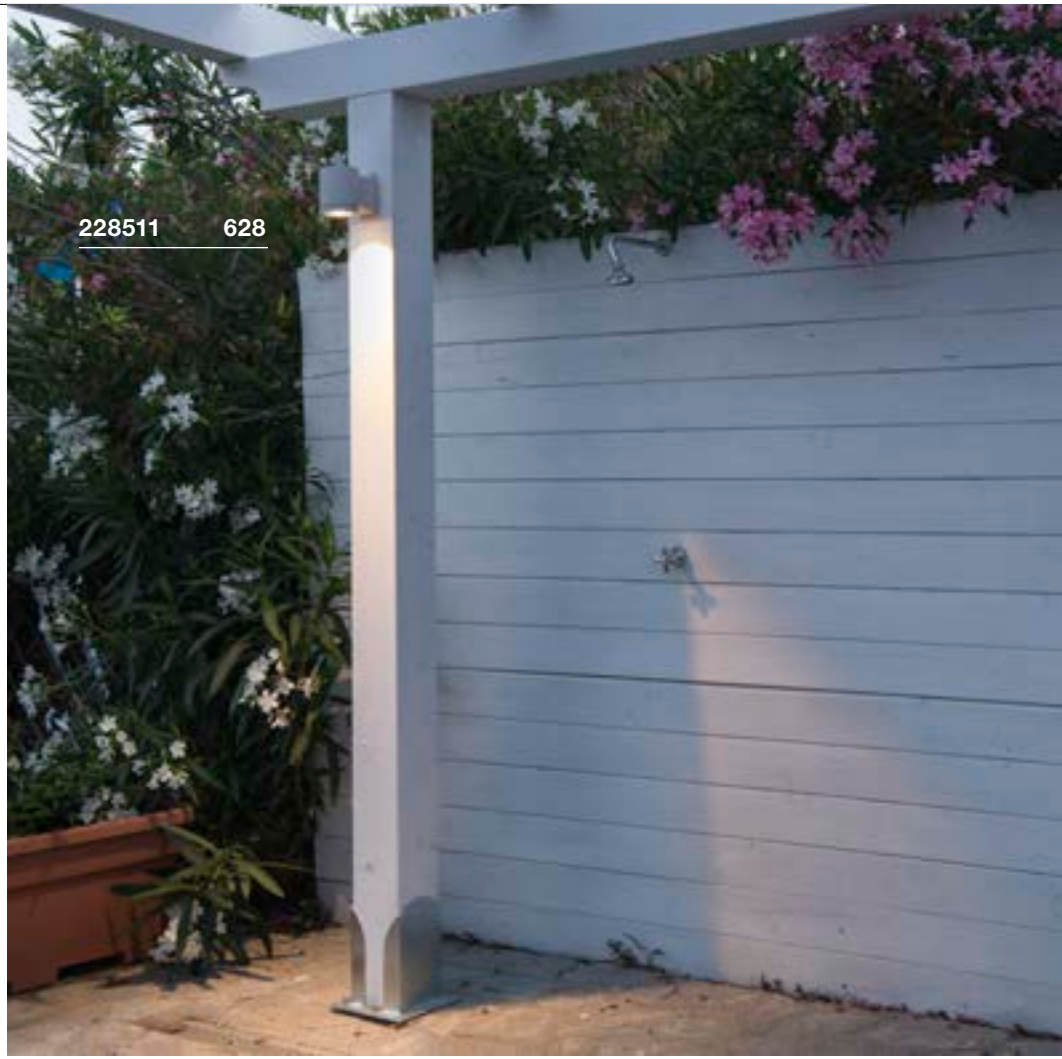

Product details

100-240V ~50/60Hz | 500mA
Total consumption: 12W
Material: Aluminium / Glass

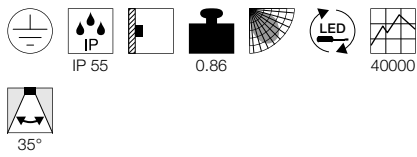

Dimensioned drawing

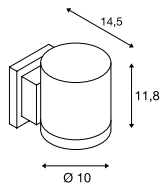

Recommended accessories

- Frame for surface mounting
Item no. 233211
- Frame for surface mounting
Item no. 233215



Variant	Item no.
900lm 3000K CRI>80 <input type="checkbox"/> white	228511
900lm 3000K CRI>80 <input checked="" type="checkbox"/> anthracite	228515

233255 629



HELIA
WL, TRIAC



A-A++ Range A++-E



• 240V LED

Product details

220-240V ~50/60Hz
Total consumption: 8W
Material: Aluminium / Glass
Dimmable: Triac C, Triac L

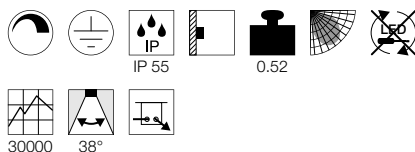

Dimensioned drawing

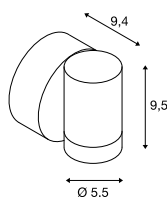

SITRA
WL, TCR-TSE



B-A++ Range A++-E



Product details

230V ~50Hz
Material: Aluminium / Glass

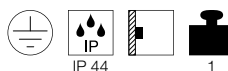

Dimensioned drawing

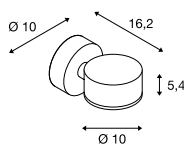

Recommended lamp

GX53 4.2W 35°
3000K 200lm EEL=A
5kWh/1000h
Item no. 550092



LED GX53 7.5W 120°
4000K 620lm EEL=A+
8kWh/1000h
Item no. 1001221



Lamp details

max. 9W TCR-TSE
Ø: 7.5 cm max. L: 3.5 cm max.

Variant	Item no.
450lm 3000K CRI>80 ■ anthracite	233225

Variant	Item no.
GX53 TCR-TSE ■ anthracite	230355

SITRA
WL



A-A++ Range A++-E

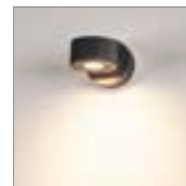

Product details

220-240V ~50/60Hz
Total consumption: 9W
Material: Aluminium / Glass

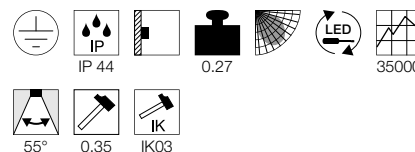

Dimensioned drawing

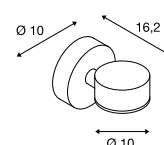

Variant	Item no.
450lm 3000K CRI>80 ■ anthracite	1002016
450lm 3000K CRI>80 □ white	1002017

ROX
WL, QPAR111

895

E-A++ Range
A++-E

- High-quality brushed finis

Product details

230V ~50Hz
Material: Aluminium / Glass



IP 44



0.9

Dimensioned drawing

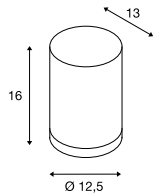

1000333 630

Recommended lamp

LED GU10 10W 38°
3000K 630lm EEL=A+
10kWh/1000h

Item no. 1001029



LED GU10 13W 30°
4000K 1300lm EEL=A+
13kWh/1000h

Item no. 1001243



Lamp details

max. 50W QPAR111

Variant	Item no.
GU10 QPAR111	
■ brushed aluminium	1000333



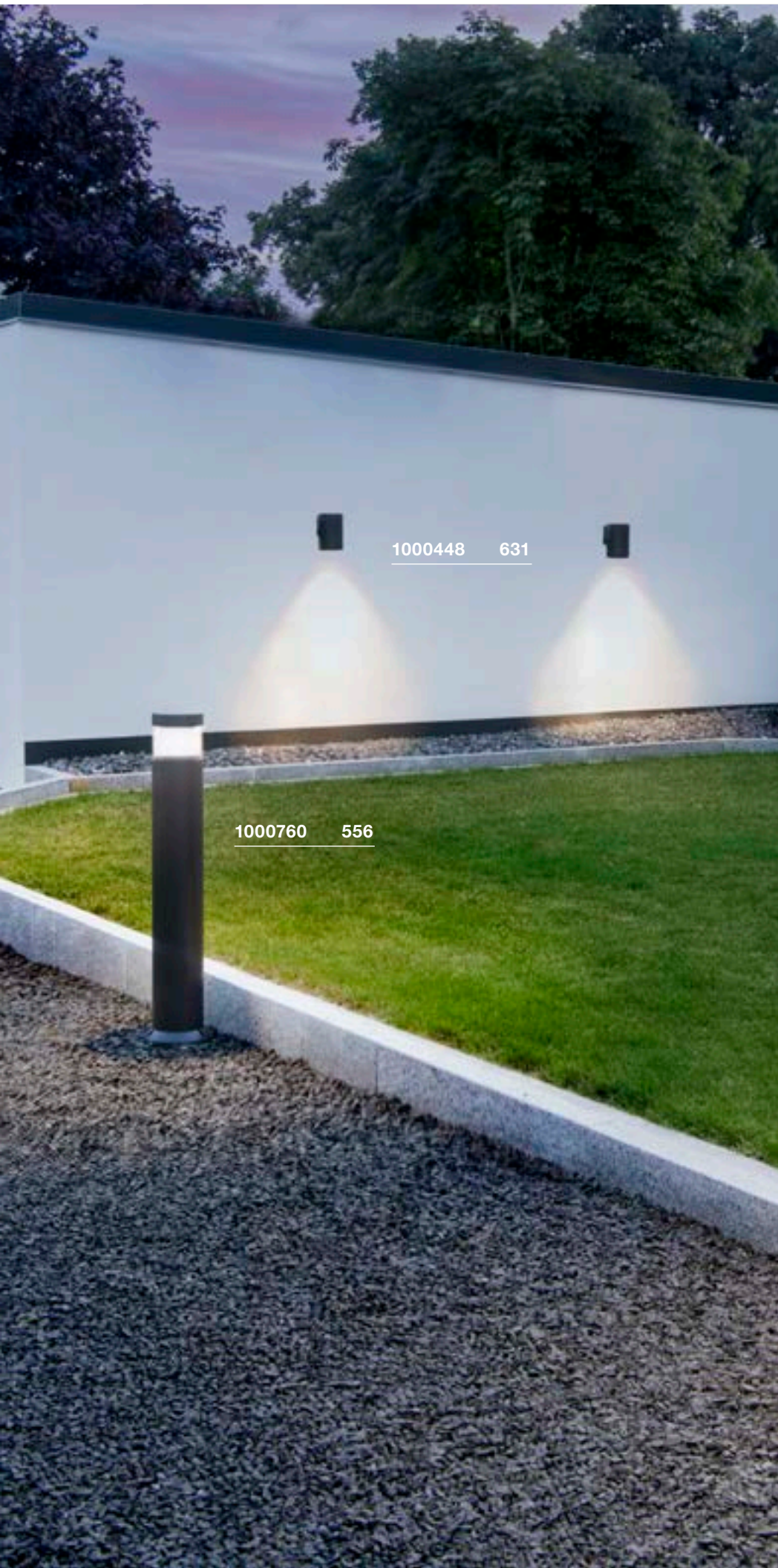

1000448 631

1000760 556

POLE PARC
WL

894

A-A++ Range A++-E

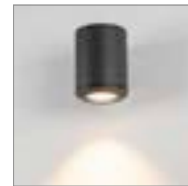

- Ideal for effective accentuation of the building architecture
- Rotation-symmetric light distribution

Product details

100-240V ~50/60Hz | 700mA
Total consumption: 28W
Material: Aluminium / Glass

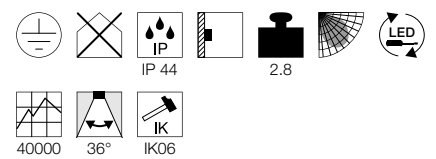

Dimensioned drawing

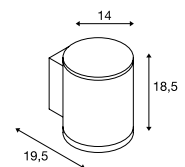

Variant	Item no.
2900lm 3000K CRI>80 ■ anthracite	1000448

DOWNUNDER OUT
Round

A-A++ Range A++-E



NEW



- The light colour can be set using a switch during installation

Product details

100-277V ~50/60Hz | 500mA
Total consumption: 4.5W
Material: Aluminium



Dimensioned drawing

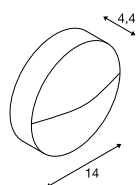

DOWNUNDER OUT
Square

A-A++ Range A++-E



NEW



- The light colour can be set using a switch during installation

Product details

100-277V ~50/60Hz | 500mA
Total consumption: 4.5W
Material: Aluminium



Dimensioned drawing

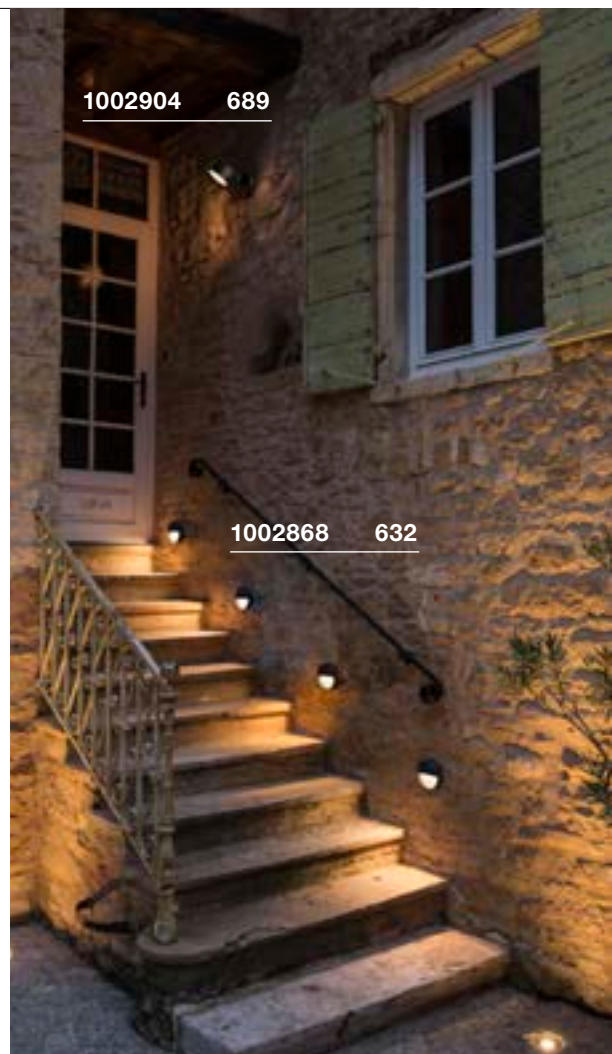
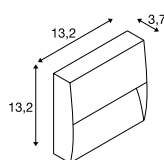

1002904 689



1002868 632

1002869 632

Variant	Item no.
140lm 3000/4000K CRI>80 ■ matt anthracite	1002868

Variant	Item no.
150lm 3000/4000K CRI>80 ■ matt anthracite	1002869



231010 633

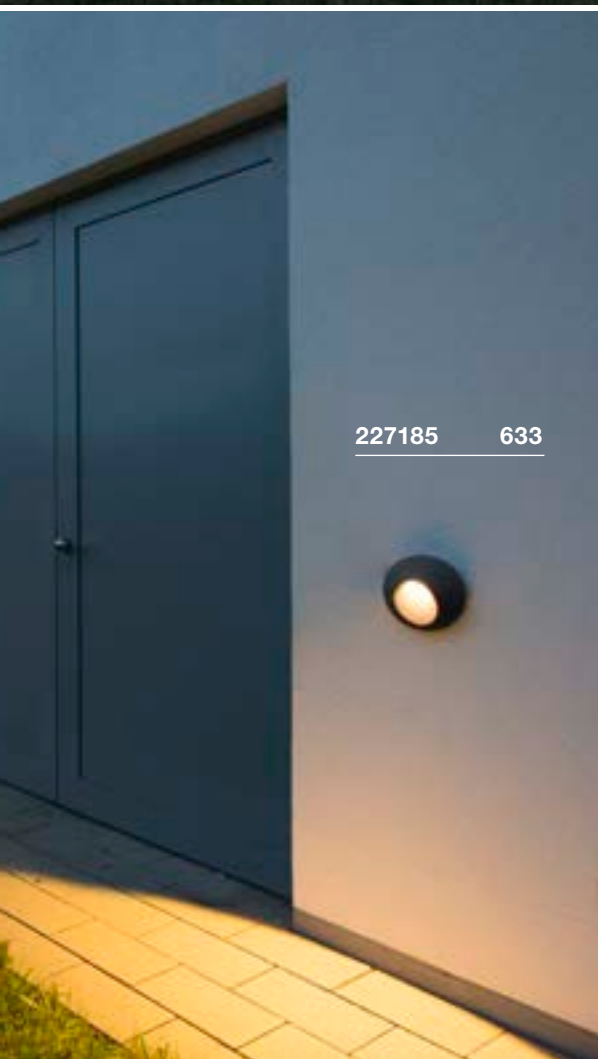

227185 633

PEMA®
WL

A-A++ Range A++-E

LED INSIDE

Color swatches: white, grey, anthracite



Product details

230V ~50Hz
Total consumption: 4.7W
Material: Aluminium

IP 44 0.3 30000

Dimensioned drawing

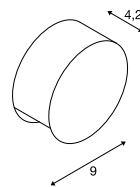

Note

Protection class IP44 only when mounted with the light emission opening pointing downwards.

Variant	Item no.
125lm 3000K CRI>80 white	231010
125lm 3000K CRI>80 grey	231012
125lm 3000K CRI>80 anthracite	231015

DELO
WL

A-A++ Range A++-E

LED INSIDE

Color swatches: anthracite



Product details

100-240V ~50/60Hz | 500mA
Total consumption: 5.8W
Material: Aluminium / Glass

IP 55 0.8 30000



Dimensioned drawing

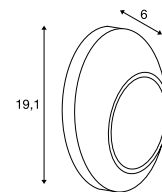

Note

Protection class IP55 only when mounted with the light emission opening pointing downwards.

Variant	Item no.
170lm 3000K CRI>80 anthracite	227185

RASCALI
WL



894

A-A++ Range
A++-E



- Unusual design
- Aesthetic accentuation of outdoor areas

Product details

220-240V ~50Hz
Total consumption: 8W
Material: Aluminium

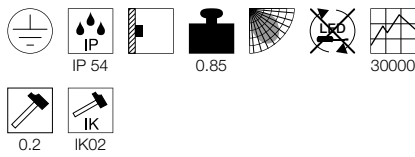

Dimensioned drawing

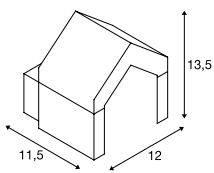

1000797 634



Variant	Item no.
330lm 3000K CRI>80 ■ anthracite	1000797



227195 635

WALLYX
WL, QPAR51E-A++ Range
A++-E

Product details

220-240V ~50/60Hz
Material: Aluminium / Glass



IP 44



0.67

Dimensioned drawing

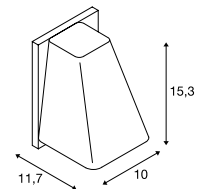

Recommended lamp

LED GU10 7.2W 36°
3000K 520lm EEL=A+
8kWh/1000h

Item no. 1001563



LED GU10 5.5W 38°
2700K 400lm EEL=A+
6kWh/1000h

Item no. 1001030



Lamp details

max. 50W QPAR51
L: 7.6 cm max.

Variant	Item no.
GU10 QPAR51 grey / transparent	227194
GU10 QPAR51 anthracite	227195
GU10 QPAR51 bronze	227198



reddot award 2018
winner



DESIGNED BY
Carsten Witsch



"Form, function, processing and ease of use should be harmonious in a product. Good design is characterized not only by the appearance of the products, but also by its functionality."

**BENDO
WL, TRIAC**



A-A++ Range
A++-E

LED
INSIDE

reddot award 2018
winner



• 240V LED

Product details

220-240V ~50/60Hz
Total consumption: 12W
Material: Aluminium / Glass
Dimmable: Triac C, Triac L

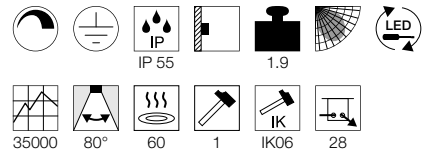

Dimensioned drawing

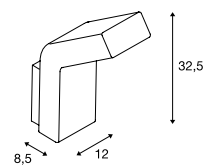

Variant	Item no.
820lm 3000K CRI>80 ■ anthracite	231865



232405 637

MERVALED SENSOR WL

A-A++ Range A++-E

LED INSIDE



- Integrated infrared sensor

Product details

220-240V ~50/60Hz | 300mA
 Total consumption: 14W
 Material: Aluminium / Acrylic

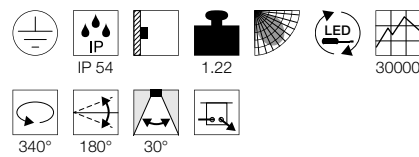

Dimensioned drawing

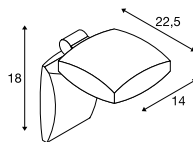

Note

Detection angle/range: 140°/8 m day/night mode the sensitivity and the switch-on time can be adjusted.

Variant	Item no.
1000lm 3000K CRI>80 ■ anthracite	232405

MERVALED WL

A-A++ Range A++-E

LED INSIDE



Product details

220-240V ~50/60Hz | 300mA
 Total consumption: 14W
 Material: Aluminium / Acrylic

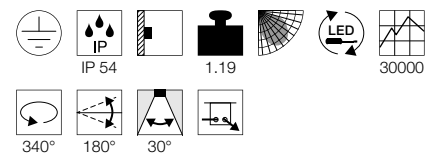

Dimensioned drawing

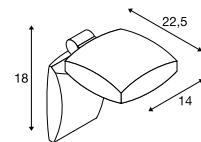

Variant	Item no.
1000lm 3000K CRI>80 ■ anthracite	232415

ABRIDOR
WL



A-A++ Range A++-E

LED INSIDE

NEW



- Switchable light colour
- Tilting lamp head

Product details

100-277V ~50/60Hz | 300mA
 Total consumption: 14W
 Material: Aluminium
 Product dimensions:
 L: 14 cm H: 16 cm D: 17.5 cm

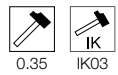
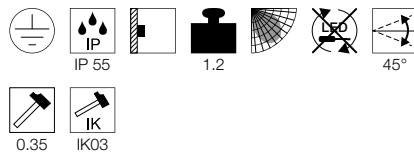

1002989 638

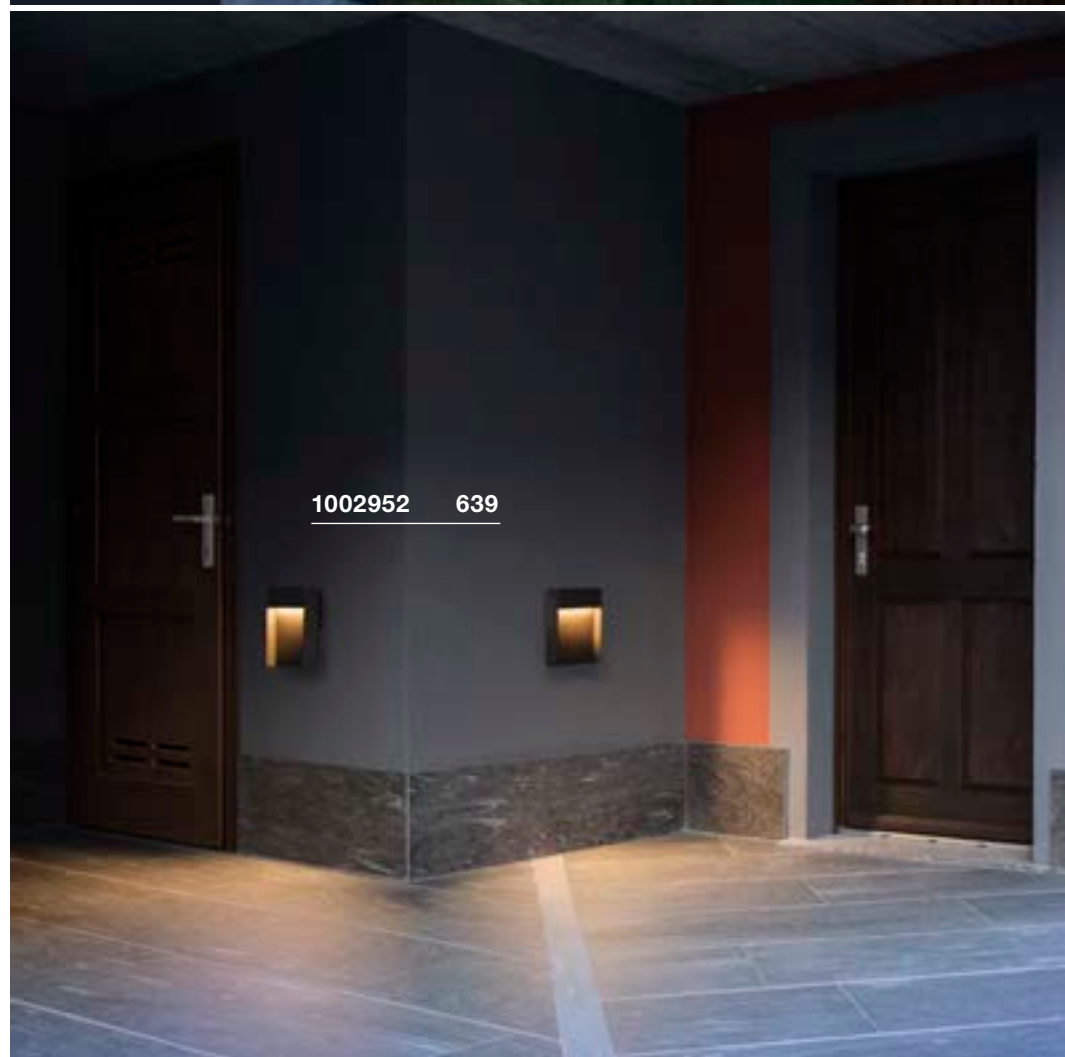

1002952 639

Variant	Item no.
750lm 3000/4000K CRI>80 ■ matt anthracite	1002989

ABRIDOR SENSOR WL



A-A++ Range A++-E



- Switchable light colour
- Tilting lamp head
- With integrated infrared motion detector

Product details

100-277V ~50/60Hz | 500mA
 Total consumption: 14W
 Material: Aluminium
 Product dimensions:
 L: 14 cm H: 16 cm D: 17.5 cm

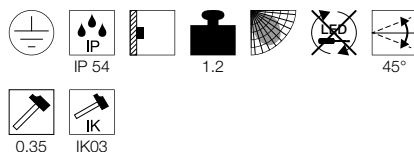

FLATT WL



A-A++ Range A++-E



- Switchable light colour

Product details

100-277V ~50/60Hz | 300mA
 Total consumption: 14W
 Material: Aluminium / Aluminium
 Product dimensions:
 W: 18 cm H: 23 cm D: 7 cm

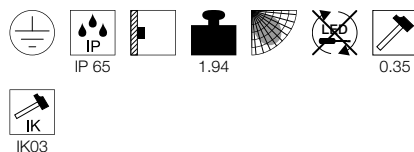

FLATT SENSOR WL



A-A++ Range A++-E



- Switchable light colour
- With integrated infrared motion detector

Product details

100-277V ~50/60Hz | 500mA
 Total consumption: 16W
 Material: Aluminium / Aluminium
 Product dimensions:
 W: 18 cm H: 23 cm D: 7 cm

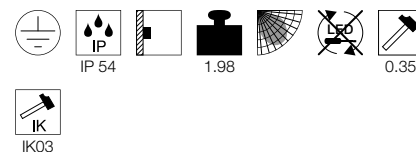

Variant	Item no.
750lm 3000/4000K CRI80 ■ matt anthracite	1002990

Variant	Item no.
460lm 3000/4000K CRI80 ■ matt anthracite / matt anthracite	1002952
500lm 3000/4000K CRI80 ■ matt anthracite / matt brown	1002953

Variant	Item no.
600lm 3000/4000K CRI80 ■ matt anthracite / matt anthracite	1002954
600lm 3000/4000K CRI80 ■ matt anthracite / matt brown	1002955

ORDI
WL

A-A++ Range A++-E



ORDI SENSOR
WL

A-A++ Range A++-E



- With integrated infrared motion detector

Product details

220-240V ~50/60Hz
Total consumption: 9W
Material: Aluminium

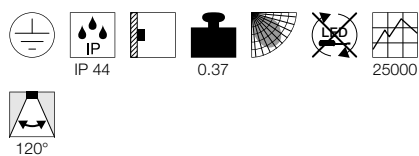

Dimensioned drawing

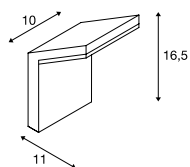

Product details

220-240V ~50/60Hz
Total consumption: 9W
Material: Aluminium

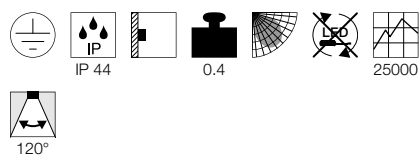

Dimensioned drawing

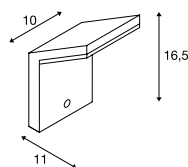

Note

Sensor range adjustable up to 9 m,
detection angle 120°

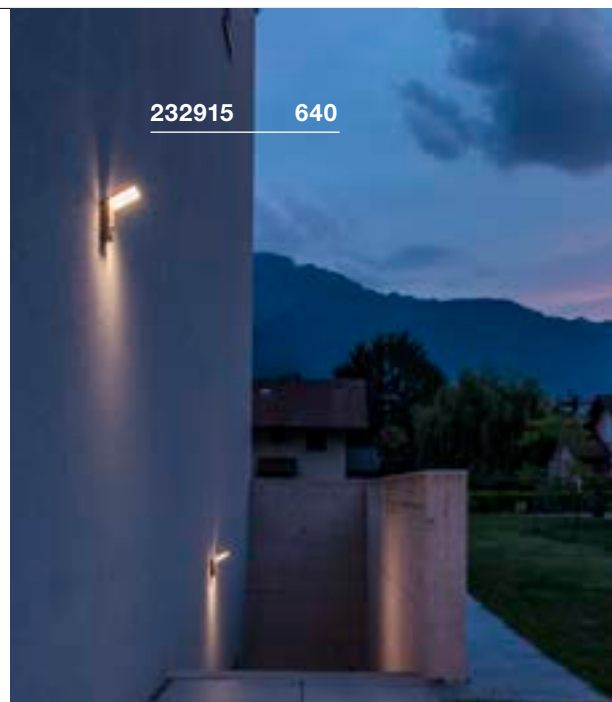

232915 640



231351 641

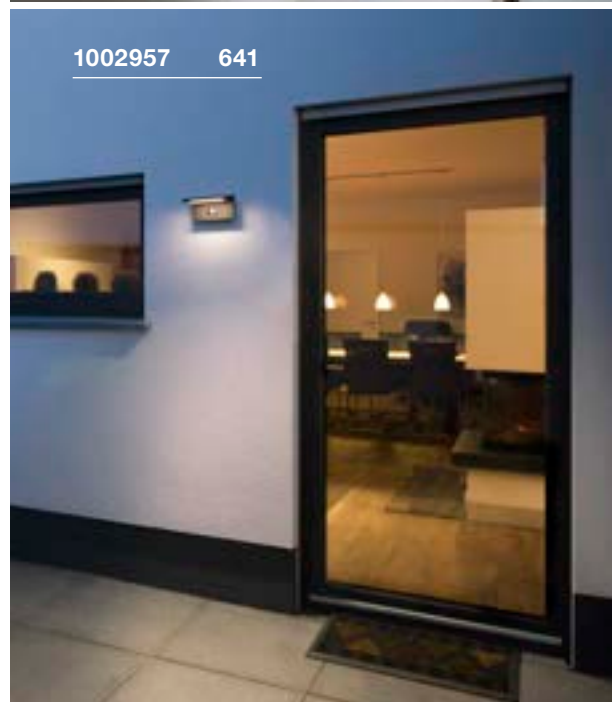

1002957 641

Variant	Item no.
500lm 3000K CRI>80 ■ anthracite	232905

Variant	Item no.
500lm 3000K CRI>80 ■ anthracite	232915

ANGOLUX WL

A-A++ Range A++-E
LED INSIDE



Product details

220-240V ~50/60Hz | 80mA
 Total consumption: 7.6W
 Material: Aluminium / Plastic

Dimensioned drawing

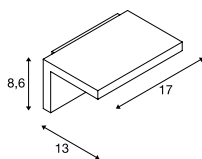

Note

Protection class IP44 only when mounted with the light emission opening pointing downwards.

Variant	Item no.
500lm 3000K CRI>80 □ white	231351
500lm 3000K CRI>80 ■ anthracite	231355

ANGOLUX SENSOR WL

A-A++ Range A++-E
LED INSIDE

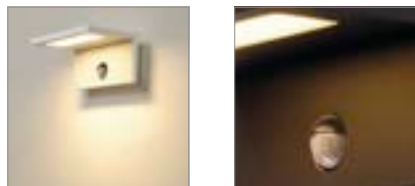

Product details

100-240V ~50/60Hz | 240mA
 Total consumption: 9.8W
 Material: Aluminium / Plastic

Dimensioned drawing

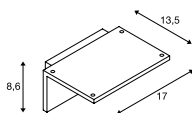

Note

Detection angle 120°, max. detection distance 9 m, adjustable actuation sensitivity and activation time
 Protection class IP44 only when mounted with the light emission opening pointing downwards

Variant	Item no.
560lm 3000K CRI>80 ■ anthracite	1001969
560lm 3000K CRI>80 □ white	1001970

ANGOLUX SOLAR WL

A-A++ Range A++-E
LED INSIDE



Product details

Battery operated
 Total consumption: 1.8W
 Material: Aluminium

Dimensioned drawing

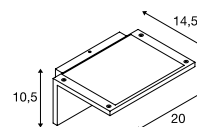

Note

Motion sensor & solar panel incl.
 Battery 3.7V 2200mAh incl.

Variant	Item no.
150lm 3000K CRI>80 ■ anthracite	1002597

IPER
WL

888

A-A++ Range
A++-ELED
INSIDE

231315 642

Product details

230V ~50Hz

Total consumption: 5W

Material: Aluminium / Plastic



IP 44



0.5



25000

Dimensioned drawing

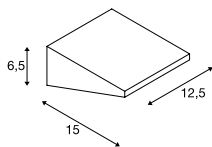

Note

Protection class IP44 only when mounted with the light emission opening pointing downwards.

Variant	Item no.
320lm 4000K CRI>70	
■ anthracite	231315



230034 643



1002071 643

PEMA®
WL, E27

A-A++ Range A++-E

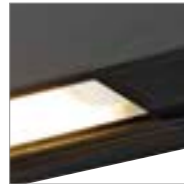

Product details

230V ~50Hz
Material: Aluminium / Glass

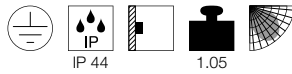

Dimensioned drawing

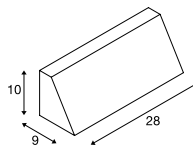

Note

Protection class IP44 only when mounted with the light emission opening pointing downwards.

Recommended lamp

E27 9W 240°
3000K 810lm EEL=A+
10kWh/1000h
Item no. 1001031



LED E27 15W 240°
3000K 1521lm EEL=A+
15kWh/1000h
Item no. 1001033



Lamp details

max. 15W
Ø: 4.5 cm max. L: 21 cm max.

Variant	Item no.
E27	
■ black	230030
E27	
■ grey / transparent	230034

PEMA®
WL

A-A++ Range A++-E



LED
INSIDE

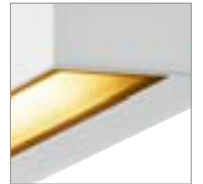
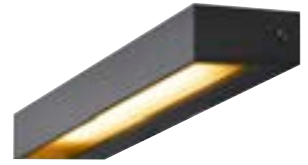

Product details

230V ~50Hz
Total consumption: 7.7W
Material: Aluminium / Glass

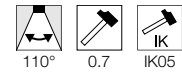

Dimensioned drawing

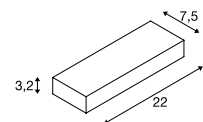

Note

Protection class IP54 only when mounted with the light emission opening pointing downwards.

Variant	Item no.
450lm 3000K CRI>80	
■ anthracite	1002069
450lm 3000K CRI>80	
□ white	1002070
450lm 3000K CRI>80	
■ grey / transparent	1002071

MALU
WL



A-A++ Range A++-E



reddot award 2019 winner



- Unusual design
- Homogeneous illumination
- Extremely wide light distribution

Product details

220-240V ~50/60Hz
Total consumption: 9.2W
Material: Aluminium / Glass

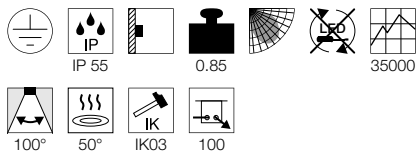

Dimensioned drawing

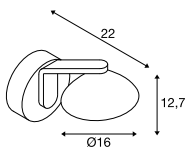

TRAPECCO DOWN
WL



A-A++ Range A++-E



Product details

230V ~50Hz
Total consumption: 10W
Material: Aluminium

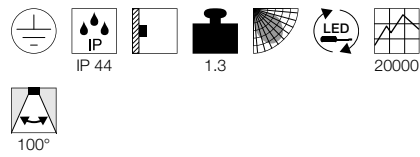

Dimensioned drawing

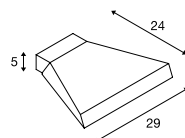

1002155 644



reddot award 2019 winner

DESIGNED BY
Philippe Stephant

Philippe Stephant

102155 644



Variant	Item no.
360lm 3000K CRI>80 ■ anthracite	1002155

Variant	Item no.
850lm 3000K CRI>80 ■ anthracite	231745



232285 645

QUADRASYL
WL, TCR-TSE



B-A++ Range A++-E

QUADRASYL
CW, TCR-TSE



B-A++ Range A++-E



• Panel: Stainless steel 304

Product details

230V ~50Hz
Material: Aluminium / Glass

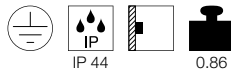

Product details

230V ~50Hz
Material: Aluminium / Stainless Steel 304

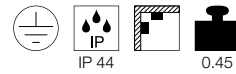

Dimensioned drawing

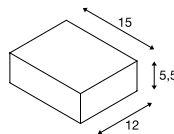

Dimensioned drawing

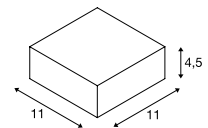

Note

Attached to the rear



231745 644

Recommended lamp

GX53 3W 120°
3000K 250lm EEL=A++
3kWh/1000h
Item no. 551372



Lamp details

max. 11W TCR-TSE
Ø: 7.5 cm max. L: 2.7 cm max.

Variant	Item no.
■ anthracite	232285

Recommended lamp

GX53 3W 120°
3000K 250lm EEL=A++
3kWh/1000h
Item no. 551372



Lamp details

max. 9W TCR-TSE
Ø: 7.5 cm max. L: 2.7 cm max.

Variant	Item no.
■ grey	111482

QUAD
WL



A-A++ Range
A++-E

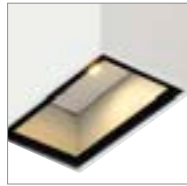

BIG QUAD
WL



A-A++ Range
A++-E

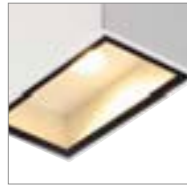

Product details

200-240V ~50/60Hz | 700mA
Total consumption: 4.6W
Material: Aluminium / Glass



Dimensioned drawing

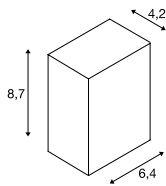

Product details

100-277V ~50/60Hz | 350mA
Total consumption: 4.5W
Material: Aluminium / Glass



Dimensioned drawing

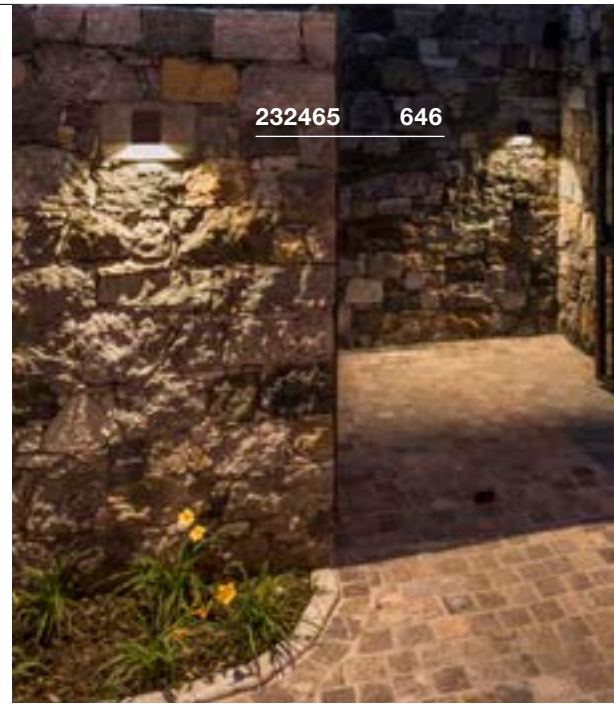
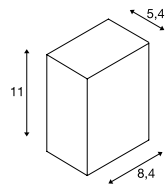

232465 646

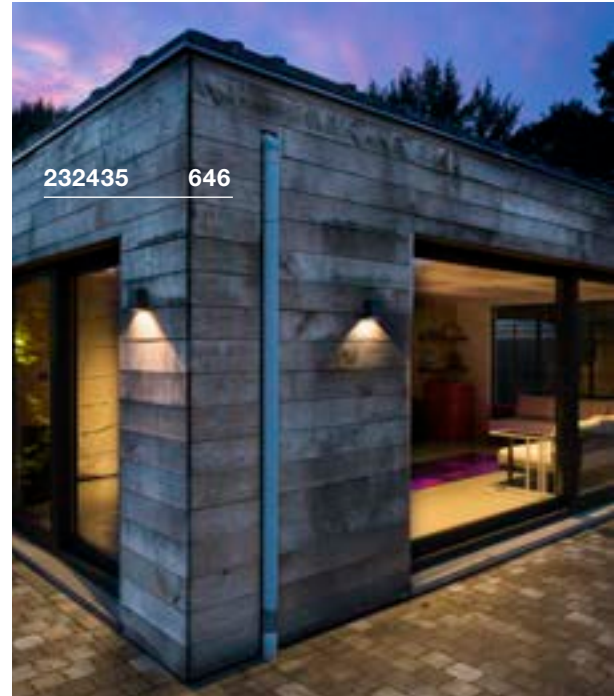

232435 646

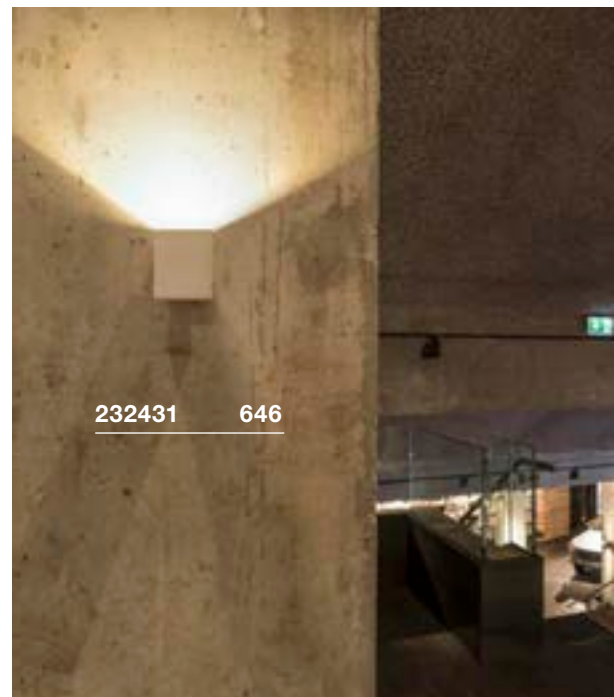

232431 646

Variant	Item no.
100lm 3000K CRI>80	
□ white	232461
80lm 3000K CRI>80	
■ anthracite	232465

Variant	Item no.
290lm 3000K CRI>80	
□ white	232431
260lm 3000K CRI>80	
■ anthracite	232435



1002605 647

SAIL
WL
 889
A-A++ Range
A++-ELED
INSIDE

NEW

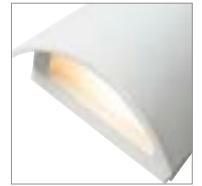
**Product details**



200-240V ~50Hz
Total consumption: 18W
Material: Aluminium

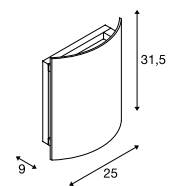

1

IK06

Dimensioned drawing

Variant	Item no.
400lm 3000K CRI>80	
■ anthracite	1002605 
590lm 3000K CRI>80	
□ white	1002606 

VILUA S
WL

A-A++ Range
A++-E

LED
INSIDE

NEW



Product details

100-277V ~50/60Hz | 700mA
Total consumption: 8.3W
Material: Aluminium / Glass

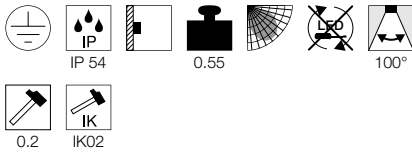

Dimensioned drawing

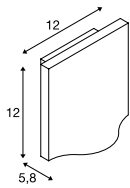

1002503 648



1002504 649

Variant	Item no.
405lm 3000K CRI>80 ■ anthracite	1002503

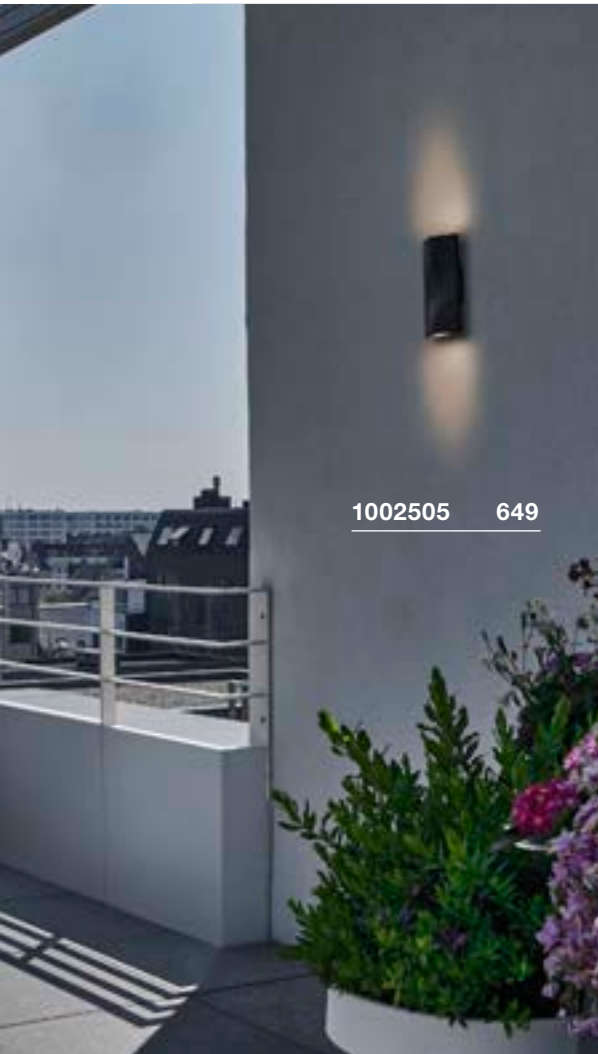

1002505 649



1002504 649

VILUA L WL

A-A++ Range A++-E

LED INSIDE

NEW



Product details

100-277V ~50/60Hz | 350mA
Total consumption: 16W
Material: Aluminium / Glass

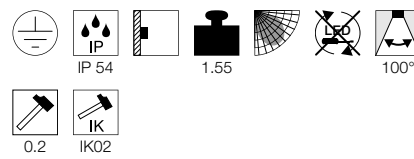

Dimensioned drawing

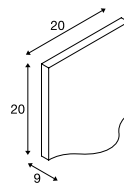

VILUA UP/DOWN, WL

A-A++ Range A++-E

LED INSIDE

NEW



Product details

100-277V ~50/60Hz | 700mA
Total consumption: 16W
Material: Aluminium / Glass

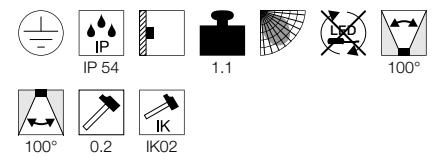

Dimensioned drawing

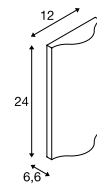

Variant	Item no.
■ anthracite	1002504

Variant	Item no.
Up: 392lm 3000K CRI>80 Down: 392lm 3000K CRI>80 ■ anthracite	1002505

THEO
WL, QPAR51



E-A++ Range A++-E



BIG THEO
WL, QPAR111



E-A++ Range A++-E



Product details

230V ~50Hz
Material: Aluminium / Glass

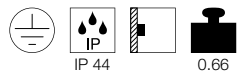

Dimensioned drawing

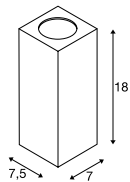

Recommended lamp

LED GU10 7.2W 36°
4000K 540lm EEL=A+
8kWh/1000h
Item no. 1001566



LED GU10 5.5W 38°
2700K 400lm EEL=A+
6kWh/1000h
Item no. 1001030



Lamp details

max. 35W QPAR51

Variant	Item no.
GU10 QPAR51	
□ white	229521
GU10 QPAR51	
■ grey / transparent	229524
GU10 QPAR51	
■ anthracite	229525

Product details

230V ~50Hz
Material: Aluminium / Glass

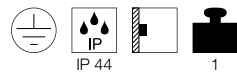

Dimensioned drawing

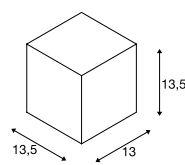

Recommended lamp

GU10 7W 13°
3000K 660lm EEL==A+
8kWh/1000h
Item no. 1001568



LED GU10 13W 140°
2700K 1000lm EEL==A+
13kWh/1000h
Item no. 1001244



Lamp details

max. 75W QPAR111

Variant	Item no.
GU10 QPAR111	
□ white	229561
GU10 QPAR111	
■ grey / transparent	229564
GU10 QPAR111	
■ anthracite	229565

229525

650



229561

650





234525 651



234521 651

BIG THEO
WL

885

A-A++ Range A++-E



LED INSIDE



Product details

100-277V ~50/60Hz | 500mA
Total consumption: 21W
Material: Aluminium / Glass

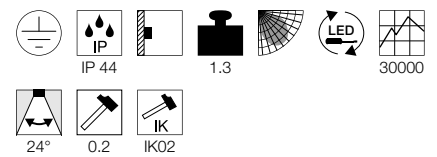

Dimensioned drawing

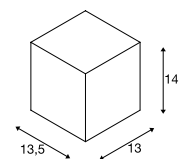

Variant	Item no.
2000lm 3000K CRI>80 white	234521
2000lm 3000K CRI>80 grey / transparent	234524
2000lm 3000K CRI>80 anthracite	234525

DELWA
WL

A-A++ Range A++-E

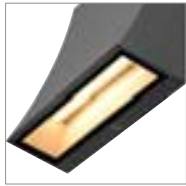

Product details

100-240V ~50/60Hz | 700mA
Total consumption: 10W
Material: Aluminium / Glass

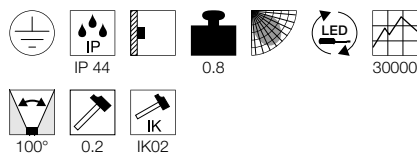

Dimensioned drawing

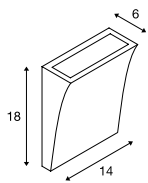

230791 652

Variant	Item no.
910lm 3000K CRI>80 □ white	1000340
910lm 3000K CRI>80 ■ grey	1000341
910lm 3000K CRI>80 ■ anthracite	1000342

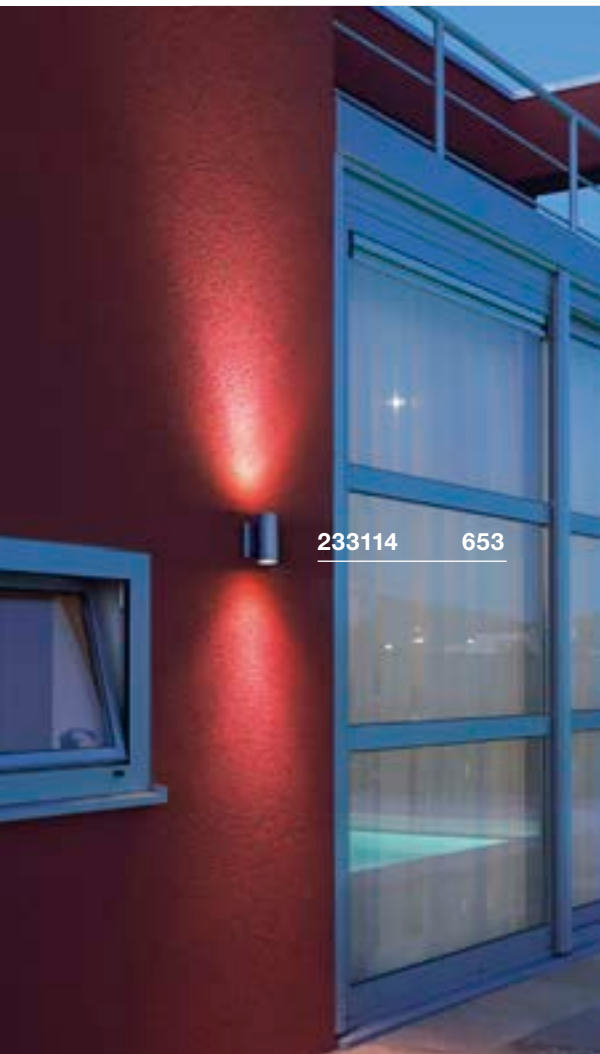

233114 653

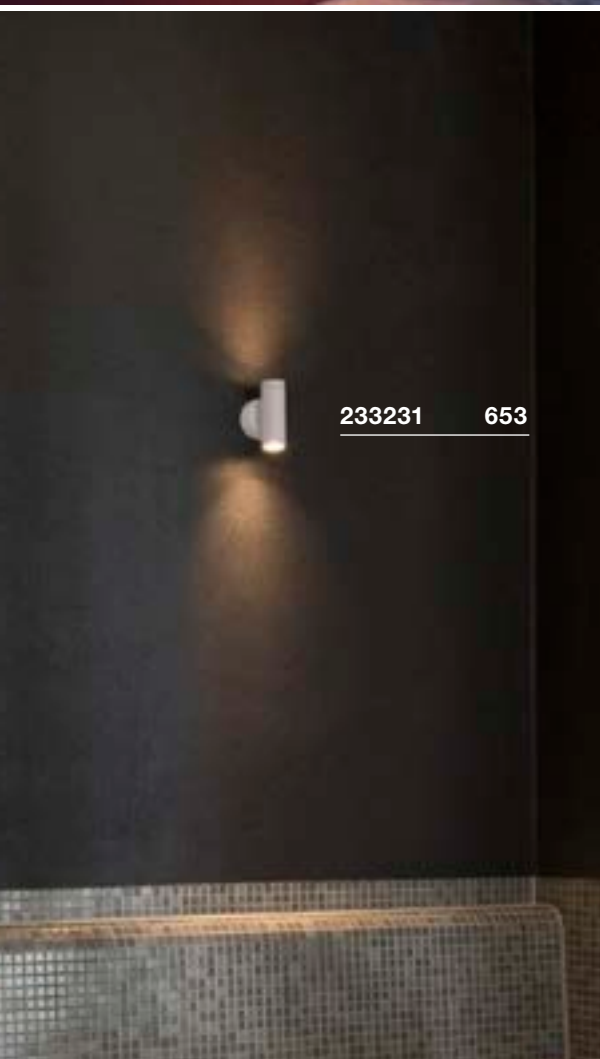

233231 653

MYRA UP/DOWN WL, QPAR51



E-A++ Range A++-E



Product details

220-240V ~50/60Hz
Material: Aluminium / Glass



Dimensioned drawing

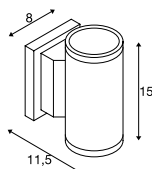

Recommended accessories

- Frame for surface mounting
Item no. 233214
- Frame for surface mounting
Item no. 233215

Recommended lamp

LED GU10 4.3W 40°
2700K 365lm EEL=A++
5kWh/1000h
Item no. 560142



LED GU10 4.3W 40°
3000K 375lm EEL=A++
5kWh/1000h
Item no. 560143



Lamp details

2x max. 35W QPAR51
Ø: 5 cm max. L: 5.7 cm max.

Variant	Item no.
GU10 QPAR51	
■ grey	233114
GU10 QPAR51	
■ anthracite	233115

HELIA UP/DOWN WL, TRIAC



A-A++ Range A++-E

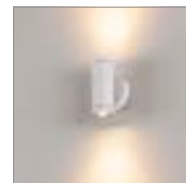

• 240V LED

Product details

220-240V ~50/60Hz
Total consumption: 12W
Material: Aluminium / Glass
Dimmable: Triac C, Triac L

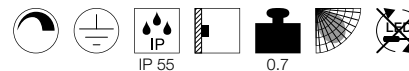

Dimensioned drawing

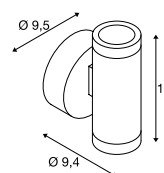

Variant	Item no.
Up: 350lm 3000K CRI>80 Down: 350lm 3000K CRI>80	
□ white	233231
Up: 350lm 3000K CRI>80 Down: 350lm 3000K CRI>80	
■ anthracite	233235

SITRA UP/DOWN WL, TCR-TSE



B-A++ Range A++-E



SITRA UP/DOWN WL



A-A++ Range A++-E



ASTINA WL, QPAR51



B-A++ Range A++-E



Product details

230V ~50Hz
Material: Aluminium / Glass

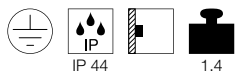

Product details

220-240V ~50/60Hz
Total consumption: 17W
Material: Aluminium / Glass

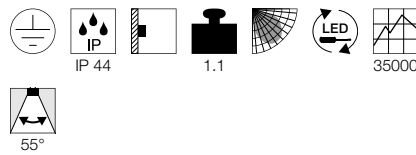

Product details

230V ~50Hz
Material: Aluminium / Glass

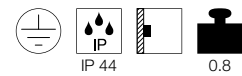

Dimensioned drawing

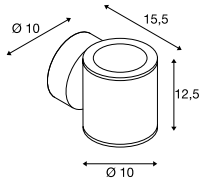

Dimensioned drawing

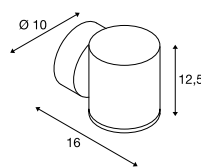

Dimensioned drawing

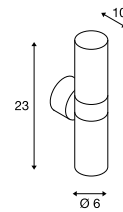

Recommended lamp

GX53 3W 120°
3000K 250lm EEL=A++
3kWh/1000h
Item no. 551372



Lamp details

2x max. 9W TCR-TSE
Ø: 7.5 cm max. L: 3.5 cm max.

Variant	Item no.
GX53 TCR-TSE	
■ anthracite	230365

Variant	Item no.
Up: 488lm 3000K CRI>80 Down: 488lm 3000K CRI>80	
■ anthracite	1002018
Up: 488lm 3000K CRI>80 Down: 488lm 3000K CRI>80	
□ white	1002041

Recommended lamp

GU10 4.3W 40°
2700K 245lm EEL=A+
5kWh/1000h
Item no. 551252



LED GU10 5.1W 48°
2700-6500K 350lm EEL=A+
6kWh/1000h
Item no. 1001918



Lamp details

2x max. 11W TCR50-SE
L: 9 cm max.

Variant	Item no.
GU10 TCR50-SE	
□ white	228771
GU10 TCR50-SE	
■ anthracite	228775
GU10 TCR50-SE	
□ matt aluminium	228776



228775 654



233302 655

**ASTINA STEEL
WL, QPAR51**



E-A++ Range A++-E

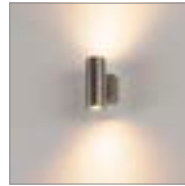

- Luminaire made from stainless steel 304
- Narrow beam characteristic for contoured accentuation of vertical surfaces

Product details

230V ~50Hz
Material: Stainless Steel 304

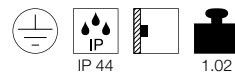

Dimensioned drawing

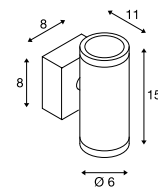

Recommended lamp

LED GU10 3.7W 36°
2700K 260lm EEL=A+
4kWh/1000h
Item no. 560122



LED GU10 4.3W 40°
2700K 365lm EEL=A++
5kWh/1000h
Item no. 560142



Lamp details

2x max. 35W QPAR51
Ø: 5.1 cm max. L: 5.7 cm max.

Variant	Item no.
GU10 QPAR51	
■ Stainless steel	233302

**ASTINA STEEL
WL**



A-A++ Range A++-E

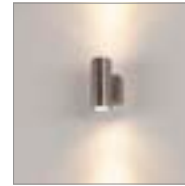

- Luminaire made from high-quality stainless steel 316
- Narrow beam characteristic for contoured accentuation of vertical surfaces

Product details

100-277V ~50/60Hz | 350mA
Total consumption: 8.7W
Material: Stainless Steel 316

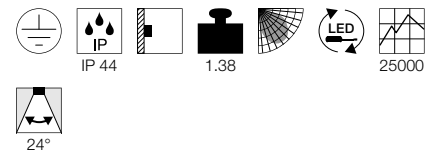

Dimensioned drawing

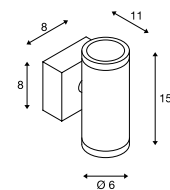

Variant	Item no.
510lm 3000K CRI>80	
■ Stainless steel	233312

ROX UP/DOWN
WL, QPAR111



E-A++ Range A++-E

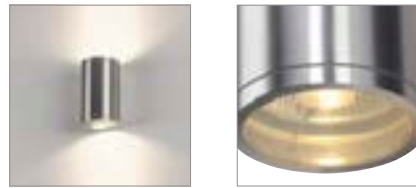

• High-quality brushed finis

Product details

230V ~50Hz
Material: Aluminium / Glass

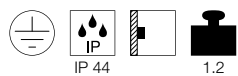

Dimensioned drawing

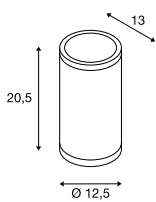

Recommended lamp

LED GU10 10W 38°
3000K 630lm EEL=A+
10kWh/1000h
Item no. 1001029



LED GU10 13W 30°
4000K 1300lm EEL=A+
13kWh/1000h
Item no. 1001243



Lamp details

2x max. 50W QPAR111

Variant	Item no.
GU10 QPAR111 brushed aluminium	1000334

ENOLA C UP/DOWN
WL



A-A++ Range A++-E



Product details

220-240V ~50/60Hz | 500mA
Total consumption: 23W
Material: Aluminium / Glass



Dimensioned drawing

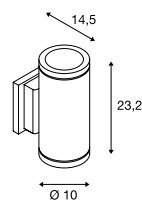

Recommended accessories

□ Frame for surface mounting
Item no. 233211
■ Frame for surface mounting
Item no. 233215



Variant	Item no.
1800lm 3000K CRI>80 white	228521
1800lm 3000K CRI>80 anthracite	228525

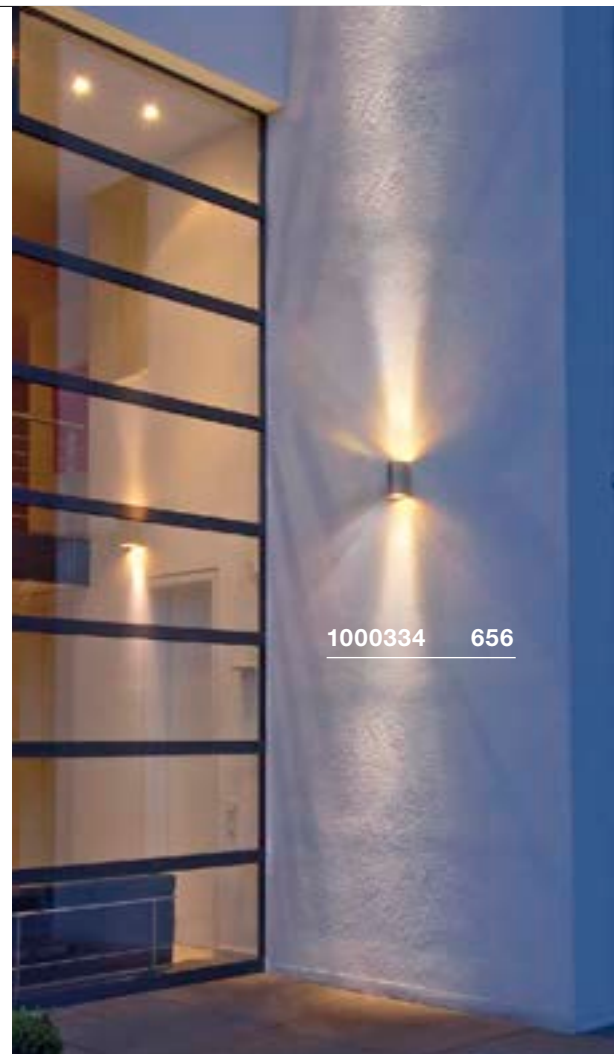

1000334 656

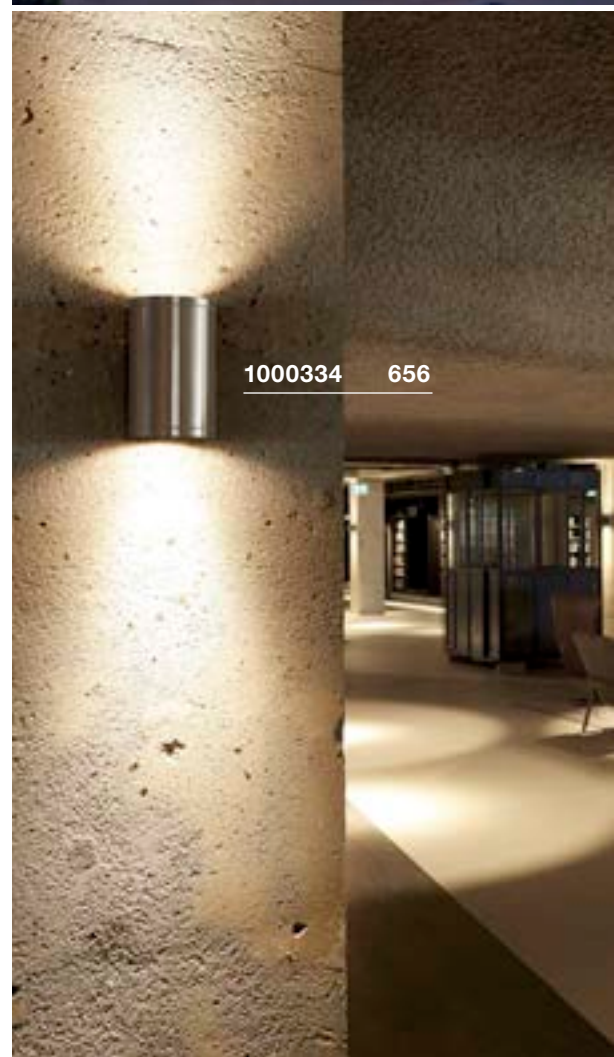

1000334 656



1000446 657

229072 682

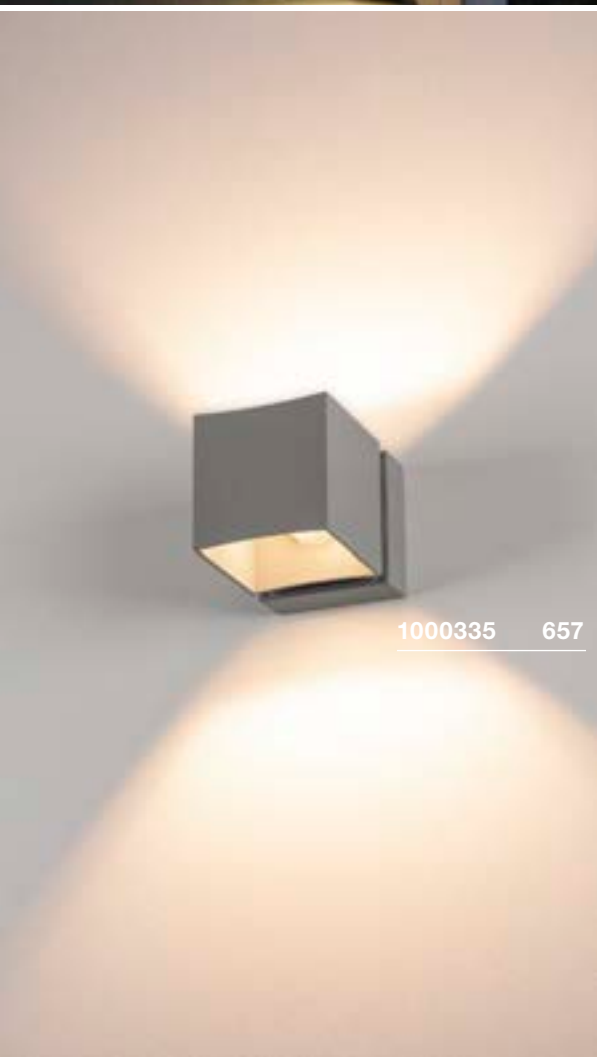

1000335 657

POLE PARC UP/DOWN WL  894

A-A++ Range A++-E



- Direct/indirect rotation-symmetric light distribution
- Ideal for effective accentuation of the building architecture

Product details

100-240V ~50/60Hz | 700mA
Total consumption: 56W
Material: Aluminium / Glass

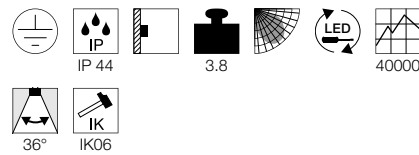

Dimensioned drawing

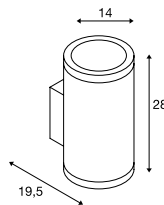

SQUARE TURN WL, G9  896

D-A+ Range A++-E

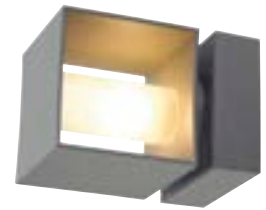

- Front part can be rotated by 360°

Product details

230V ~50Hz
Material: Aluminium / Glass



Dimensioned drawing

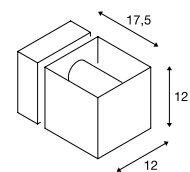

Recommended lamp

G9 2.5W
2700K 180lm EEL=A+
3kWh/1000h
Item no. 560302

LED G9 3.5W
2800K 300lm EEL=A+
4kWh/1000h
Item no. 1002131



Lamp details

max. 42W QT14
Ø: 3.5 cm max. L: 8 cm max.

Variant	Item no.
Up: 2900lm 3000K CRI>80 Down: 2900lm 3000K CRI>80 ■ anthracite	1000446

Variant	Item no.
G9 QT14 ■ grey	1000335

QUAD UP/DOWN 12
WL



A-A++ Range A++-E



LED INSIDE



QUAD UP/DOWN 15
WL



A-A++ Range A++-E



LED INSIDE

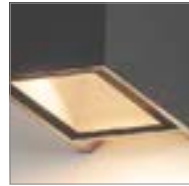
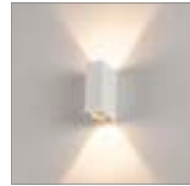

232445 658



Product details

200-240V ~50/60Hz | 700mA
Total consumption: 6.8W
Material: Aluminium / Glass

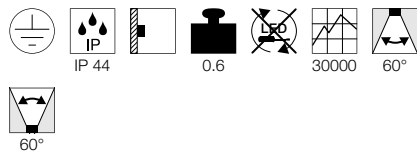

Product details

100-277V ~50/60Hz | 350mA
Total consumption: 8.6W
Material: Aluminium / Glass

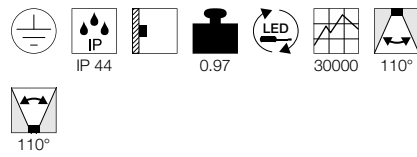

Dimensioned drawing

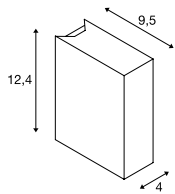

Note

Installation surface at narrow side of housing

Dimensioned drawing

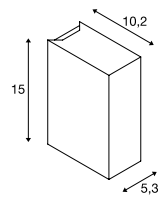

Note

Installation surface at narrow side of housing

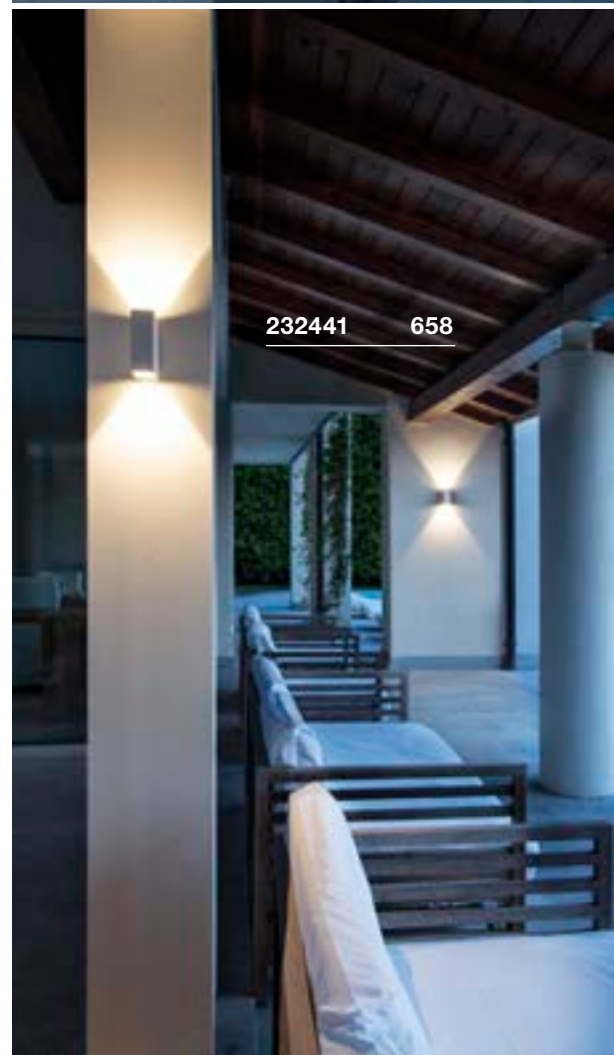

Variant	Item no.
175lm 3000K CRI>80	
□ white	232471
140lm 3000K CRI>80	
■ anthracite	232475

Variant	Item no.
290lm 3000K CRI>80	
□ white	232441
260lm 3000K CRI>80	
■ anthracite	232445



232471 658

BIG QUAD UP/DOWN WL

A-A++ Range A++-E



LED INSIDE

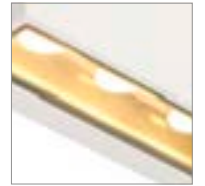

Product details

200-240V ~50/60Hz | 350mA
 Total consumption: 8.8W
 Material: Aluminium / Glass

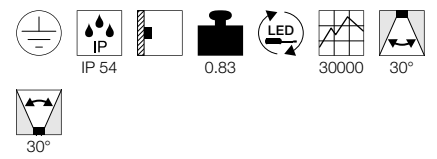

Dimensioned drawing

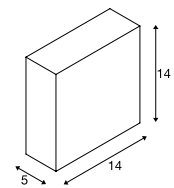

Variant	Item no.
240lm 3000K CRI>80 <input type="checkbox"/> white	232451
240lm 3000K CRI>80 <input checked="" type="checkbox"/> anthracite	232455

MANA OUT
WL



A-A++ Range
A++-E



- Narrower beam possible using provided accessory

Product details

220-240V ~50/60Hz
 Total consumption: 12W
 Material: Aluminium / Steel
 Dimmable: Triac C, Triac L
 Product dimensions:
 L: 16 cm W: 16 cm H: 9.3 cm

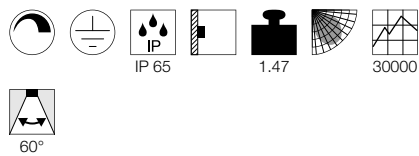

1002900 660

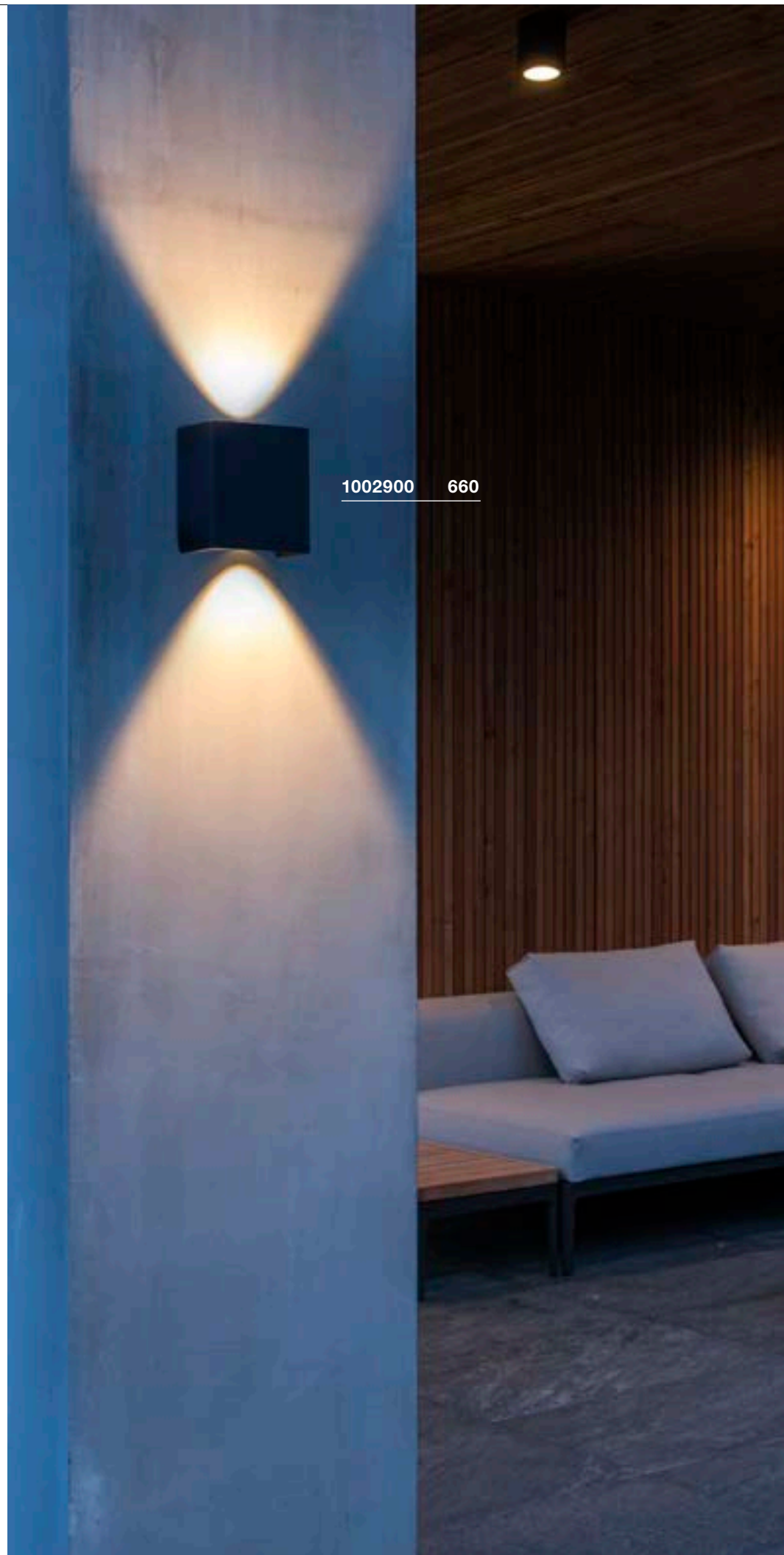

Variant	Item no.
650lm 3000K CRI>80 ■ anthracite	1002900
650lm 3000K CRI>80 ■ rust / anthracite	1002902



232495 661



232495 661

**BOX-L
WL, E27**

A-A++ Range A++-E

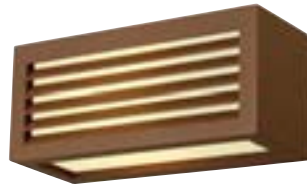

Product details

220-240V ~50/60Hz
 Material: Aluminium / Acrylic

IP 44 1.1

Dimensioned drawing

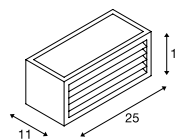

Recommended lamp

LED E27 9.1W 240°
 2700K 760lm EEL=A+
 10kWh/1000h
Item no. 560402



LED E27 9W 240°
 3000K 810lm EEL=A+
 10kWh/1000h
Item no. 1001031



Lamp details

max. 18W
 Ø: 6 cm max. L: 17.5 cm max.

Variant	Item no.
E27 white	232491
E27 anthracite	232495
E27 rust	232497

**BOX-L
WL**

A-A++ Range A++-E



Product details

220-240V ~50/60Hz
 Total consumption: 19W
 Material: Aluminium / Acrylic

IP 44 1.2 30000
 0.7 IK05

Dimensioned drawing

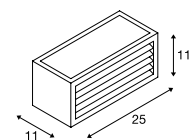

Variant	Item no.
480lm 3000K CRI>80 white	1002037
480lm 3000K CRI>80 anthracite	1002035
480lm 3000K CRI>80 rust	1002036

BOX UP/DOWN
WL, QT-DE12D-C Range
A++-E

232485 662

Product details

220-240V ~50/60Hz

Material: Aluminium / Glass

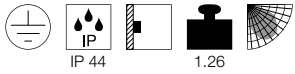

IP 44

1.26

Dimensioned drawing

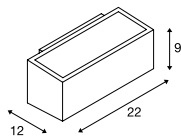

Recommended lamp

R7s 78mm 5.5W 330°
3000K 530lm EEL=A+
6kWh/1000h

Item no. 560332



Lamp details

max. 80W QT-DE12

Variant	Item no.
R7s 78mm QT-DE12	
□ white	232481
R7s 78mm QT-DE12	
■ anthracite	232485



1002033 663

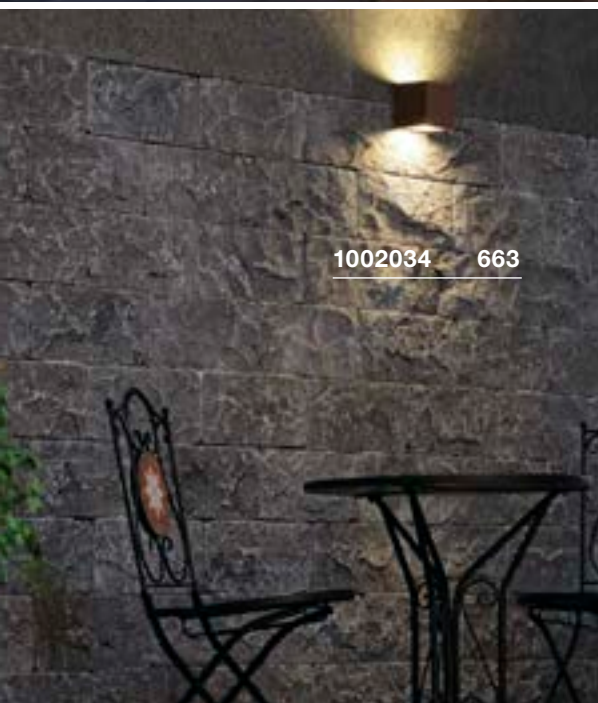

1002034 663



1002034 663

SITRA CUBE
WL, TCR-TSE



B-A++ Range A++-E



SITRA CUBE
WL



A-A++ Range A++-E



LED INSIDE

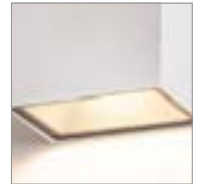

Product details

220-240V ~50/60Hz
Material: Aluminium / Glass

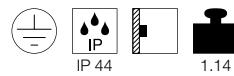

Dimensioned drawing

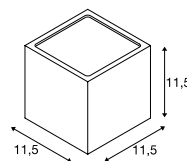

Product details

100-277V ~50/60Hz | 500mA
Total consumption: 10W
Material: Aluminium / Glass

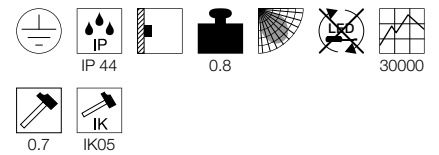

Dimensioned drawing

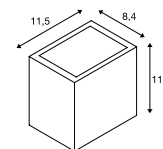

Recommended lamp

GX53 3W 120°
3000K 250lm EEL=A++
3kWh/1000h
Item no. 551372



Lamp details

2x max. 9W TCR-TSE
Ø: 7.5 cm max. L: 2.7 cm max.

Variant	Item no.
GX53 TCR-TSE	
white	232531
GX53 TCR-TSE	
anthracite	232535
GX53 TCR-TSE	
rust	232537

Variant	Item no.
Up: 560lm 3000K CRI>80 Down: 560lm 3000K CRI>80	
anthracite	1002032
Up: 560lm 3000K CRI>80 Down: 560lm 3000K CRI>80	
white	1002033
Up: 560lm 3000K CRI>80 Down: 560lm 3000K CRI>80	
rust	1002034

LOGS
WL



A-A++ Range
A++-E



LED
INSIDE

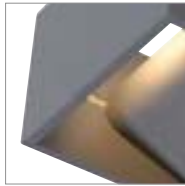
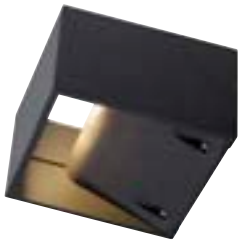

Product details

100-240V ~50/60Hz | 500mA
Total consumption: 8W
Material: Aluminium



Dimensioned drawing

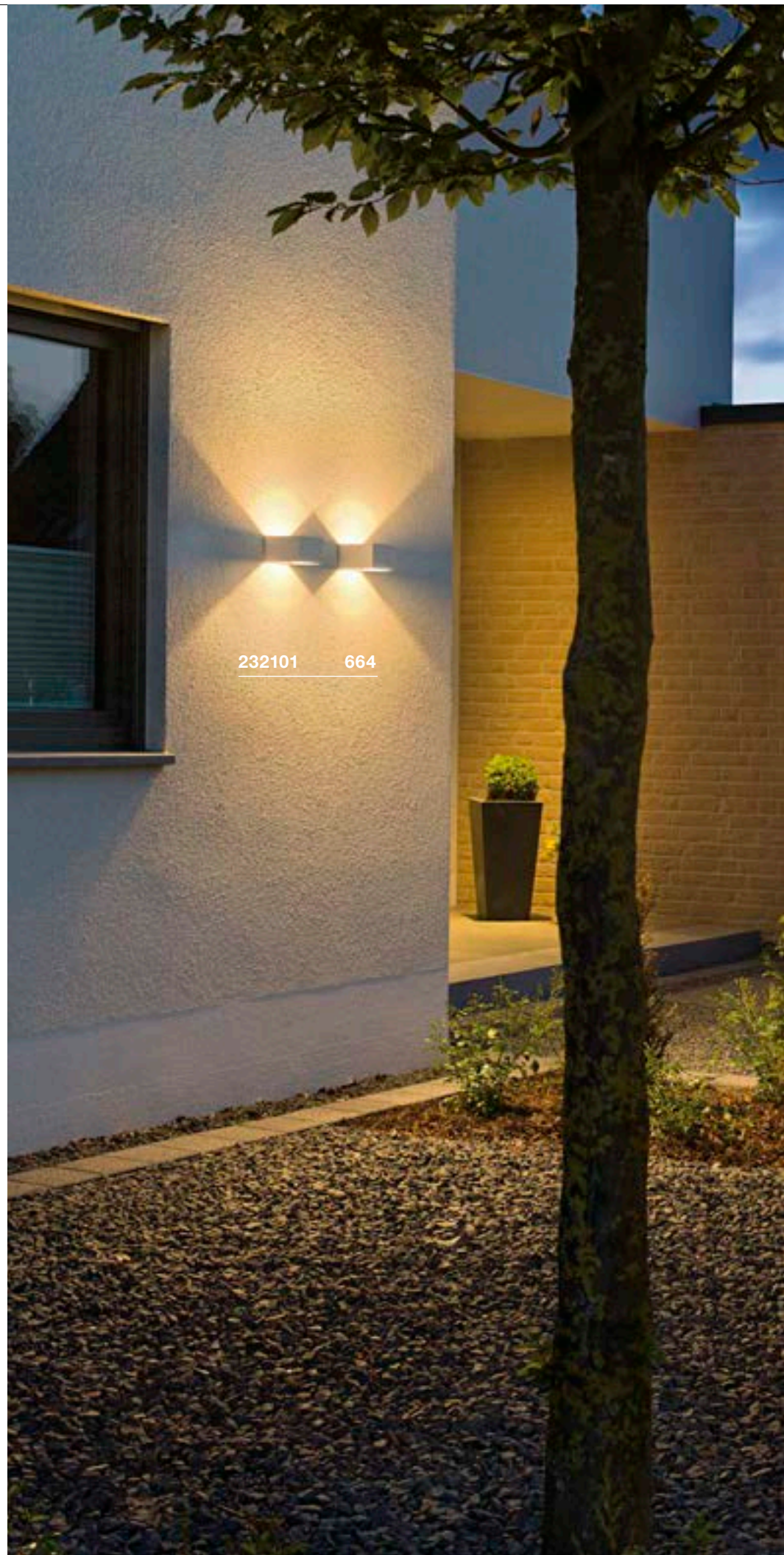
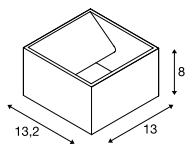

232101 664

Variant	Item no.
650lm 3000K CRI>80 white	232101
550lm 3000K CRI>80 grey	232104
420lm 3000K CRI>80 anthracite	232105



229535 665



229532 665

THEO UP/DOWN
WL, QPAR51



E-A++ Range A++-E



Product details

220-240V ~50/60Hz
Material: Aluminium / Glass

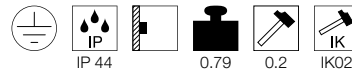

Dimensioned drawing

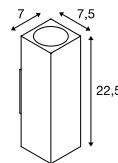

Recommended lamp

LED GU10 7W 25/40/55°
3000K 300lm EEL=A
7kWh/1000h
Item no. 560603



LED GU10 4.3W 40°
2700K 365lm EEL=A++
5kWh/1000h
Item no. 560142



Lamp details

2x max. 35W QPAR51

Variant	Item no.
GU10 QPAR51	
□ white	229531
GU10 QPAR51	
▒ grey / transparent	229532
GU10 QPAR51	
■ anthracite	229535
GU10 QPAR51	
□ matt aluminium	1000331

BIG THEO UP/DOWN
WL, QPAR111



E-A++ Range A++-E



Product details

230V ~50Hz
Material: Aluminium / Glass



Dimensioned drawing

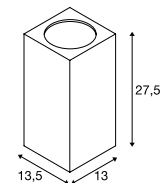

Recommended lamp

LED GU10 10W 38°
3000K 630lm EEL=A+
10kWh/1000h
Item no. 1001029



LED GU10 7.3W 13°
4000K 660lm EEL=A+
8kWh/1000h
Item no. 1000942



Lamp details

2x max. 75W QPAR111

Variant	Item no.
GU10 QPAR111	
□ white	229571
GU10 QPAR111	
▒ grey / transparent	229574
GU10 QPAR111	
■ anthracite	229575

BIG THEO FLOOD UP/DOWN WL



A-A++ Range A++-E



BIG THEO BEAM UP/ FLOOD DOWN WL



A-A++ Range A++-E



Product details

100-240V ~50/60Hz | 1000mA
 Total consumption: 42W
 Material: Aluminium / Glass

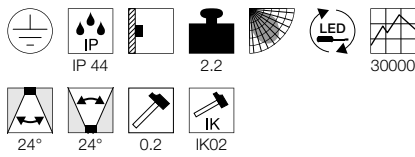

Dimensioned drawing

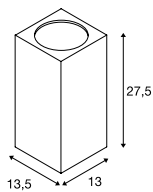

Product details

120-240V ~50/60Hz | 500mA
 Total consumption: 29W
 Material: Aluminium / Glass

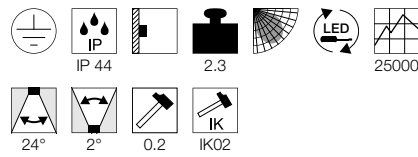

Dimensioned drawing

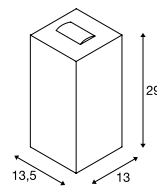

Variant	Item no.
Up: 2000lm 3000K CRI>80 Down: 2000lm 3000K CRI>80	
white	234501
Up: 2000lm 3000K CRI>80 Down: 2000lm 3000K CRI>80	
grey / transparent	234504
Up: 2000lm 3000K CRI>80 Down: 2000lm 3000K CRI>80	
anthracite	234505

Variant	Item no.
Flood: 2000lm 3000K CRI>80 Beam: 130lm 3000K CRI>80	
white	234511
Flood: 2000lm 3000K CRI>80 Beam: 130lm 3000K CRI>80	
grey / transparent	234514
Flood: 2000lm 3000K CRI>80 Beam: 130lm 3000K CRI>80	
anthracite	234515





234504 666

OUT-BEAM UP/DOWN
WL, QT-DE12

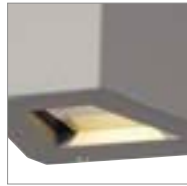

OUT-BEAM UP/DOWN
WL

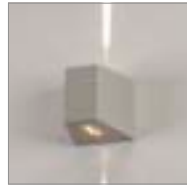

Product details

230V ~50/60Hz
Material: Aluminium / Glass

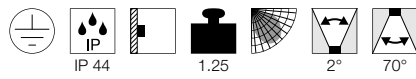

Dimensioned drawing

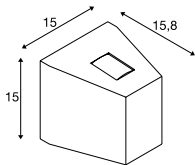

Product details

120-277V ~50/60Hz | 500mA
Total consumption: 15W
Material: Aluminium / Glass

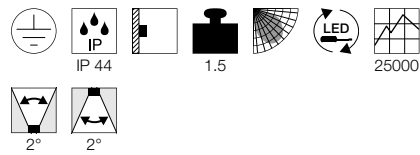

Dimensioned drawing

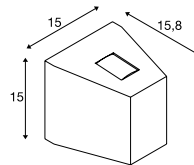

Lamp details

80W QT-DE12
L: 7.8 cm max.

Variant	Item no.
R7s 78mm QT-DE12 ■ grey	1000587
R7s 78mm QT-DE12 ■ anthracite	1000588

Variant	Item no.
Up: 50lm 3000K CRI>80 Down: 50lm 3000K CRI>80	229694
■ grey / transparent Up: 50lm 3000K CRI>80 Down: 50lm 3000K CRI>80 ■ anthracite	229695



1000587 668

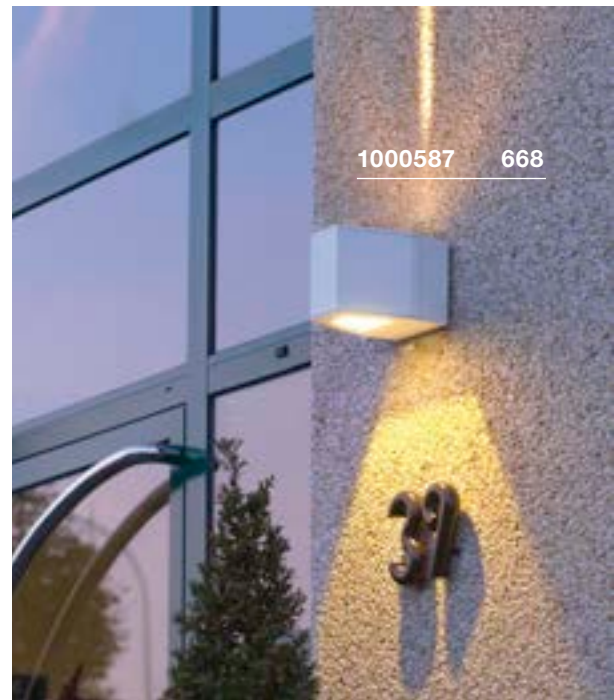

1000587 668

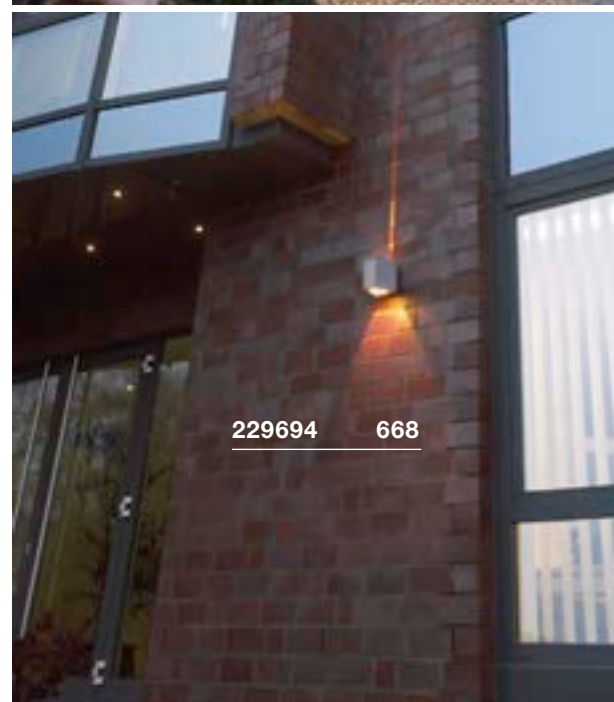

229694 668

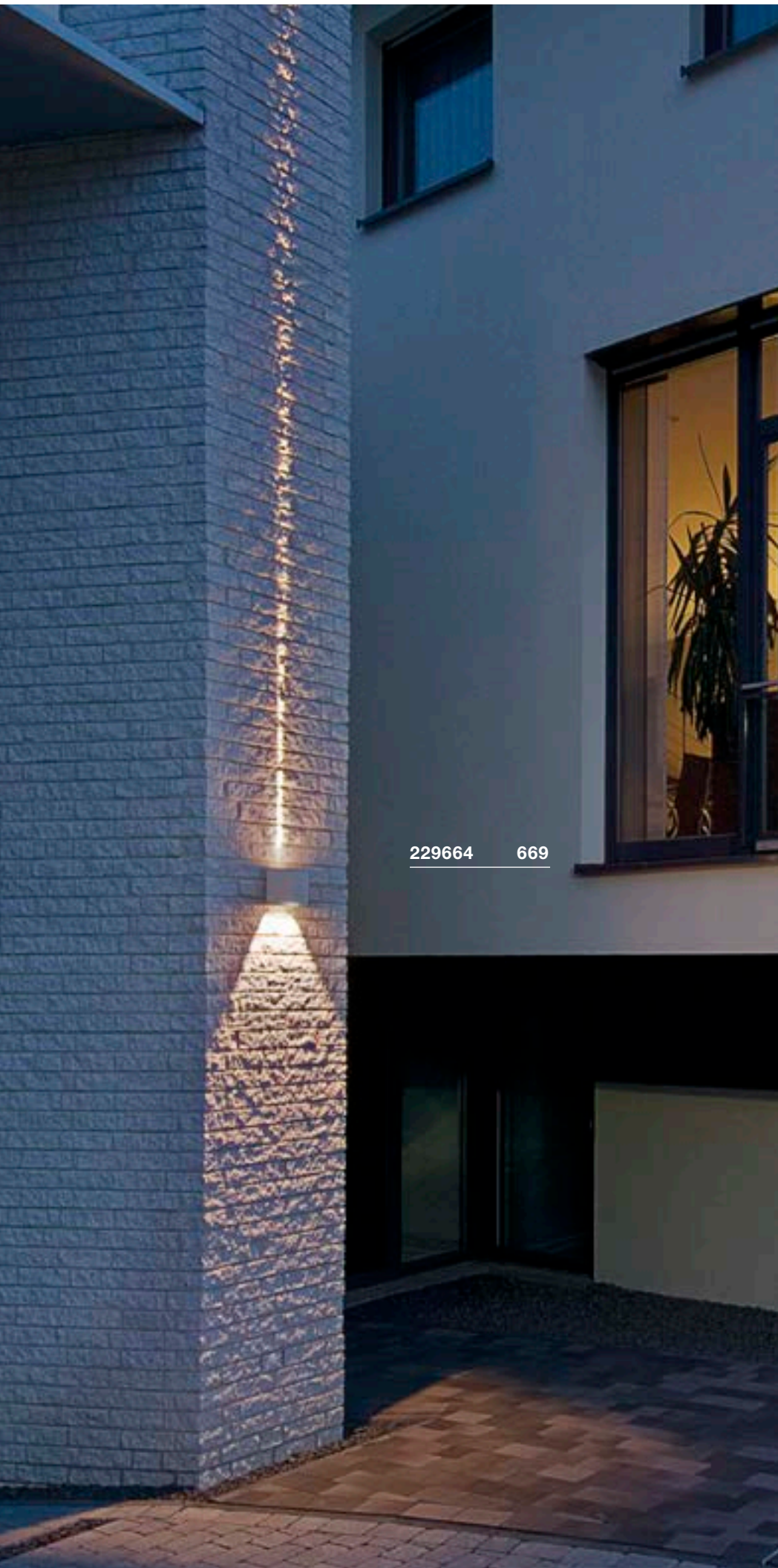

229664 669

OUT-BEAM UP/FLOOD DOWN WL

A-A++ Range A++-E

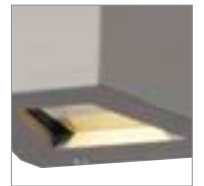

Product details

120-277V ~50/60Hz | 500mA
 Total consumption: 18W
 Material: Aluminium / Glass

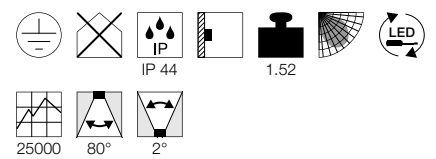

Dimensioned drawing

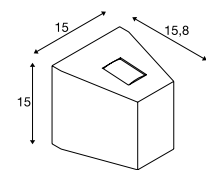

Variant	Item no.
Flood: 690lm 3000K CRI>80 Beam: 50lm 3000K CRI>80	229664
grey / transparent	
Flood: 690lm 3000K CRI>80 Beam: 50lm 3000K CRI>80	229665
anthracite	

ESKINA D
Display



A-A++ Range A++-E



• Switchable light colour

Product details

220-240V ~50/60Hz | 350mA
Total consumption: 14.5W
Material: Aluminium
Dimmable: C

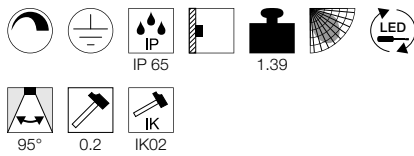

Dimensioned drawing

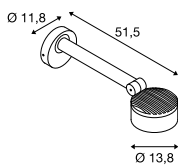

TODAY PRO
Display

A-A++ Range A++-E



Product details

220-240V ~50/60Hz | 640mA
Total consumption: 29W
Material: Aluminium

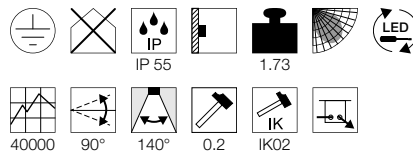

Dimensioned drawing

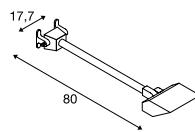

TODAY
Display

A-A++ Range A++-E



Product details

220-240V ~50/60Hz | 640mA
Total consumption: 29W
Material: Aluminium

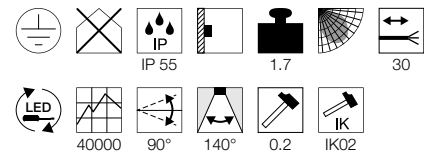

Dimensioned drawing

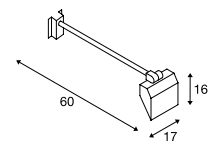

Note

Open cable end

Variant	Item no.
1000lm 3000/4000K CRI>80	
■ matt anthracite	1002905

Variant	Item no.
2800lm 4000K CRI>70	
■ black	1000880
2800lm 4000K CRI>70	
□ white	1000881
2800lm 4000K CRI>70	
■ grey	1000882

Variant	Item no.
2800lm 4000K CRI>70	
■ black	227700
2800lm 4000K CRI>70	
□ white	227701



MYRA DISPLAY
WL, straight, QPAR51

892

E-A++ Range A++-E



Product details

220-240V ~50/60Hz
Material: Aluminium

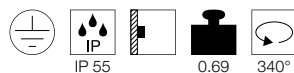

Dimensioned drawing

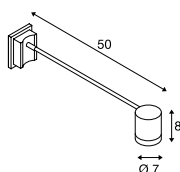

Recommended accessories

■ Frame for surface mounting

Item no. 233214

■ Frame for surface mounting

Item no. 233215

Recommended lamp

LED GU10 7.2W 36°
4000K 540lm EEL=A+
8kWh/1000h

Item no. 1001564

LED GU10 4.3W 40°
2700K 365lm EEL=A++
5kWh/1000h

Item no. 560142

Lamp details

max. 50W QPAR51
Ø: 5 cm max. L: 5.7 cm max.

Variant	Item no.
GU10 QPAR51	
■ grey	233124
GU10 QPAR51	
■ anthracite	233125

MYRA DISPLAY
WL, curved, QPAR51

892

E-A++ Range A++-E



Product details

220-240V ~50/60Hz
Material: Aluminium

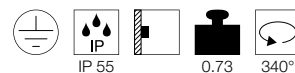

Dimensioned drawing

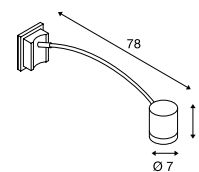

Recommended accessories

■ Frame for surface mounting

Item no. 233214

■ Frame for surface mounting

Item no. 233215

Recommended lamp

GU10 5.5W 36°
2800K 420lm EEL=A+
6kWh/1000h

Item no. 1001217

LED GU10 3.7W 36°
2700K 260lm EEL=A+
4kWh/1000h

Item no. 560122

Lamp details

max. 50W QPAR51
Ø: 5 cm max. L: 5.7 cm max.

Variant	Item no.
GU10 QPAR51	
■ grey	233134
GU10 QPAR51	
■ anthracite	233135

PHOTONIA
CL, E27



E-A++ Range A++-E



Product details

220-240V ~50/60Hz
Material: Aluminium / Glass



Dimensioned drawing

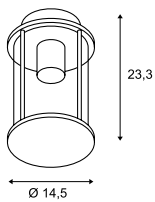

Recommended lamp

LED E27 7.1W 330°
2700K 806lm EEL=A+
8kWh/1000h
Item no. 1001756



LED E27 5W 330°
2000K 500lm EEL=A+
5kWh/1000h
Item no. 560741



Lamp details

max. 60W
Ø: 9 cm max. L: 15 cm max.

Variant	Item no.
E27	
■ anthracite	232055

MOLAT
CL, E27



E-A++ Range A++-E



Product details

230V ~50/60Hz
Material: Aluminium / Glass



Dimensioned drawing

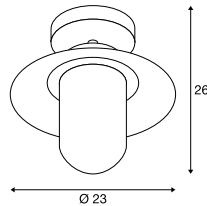

Recommended lamp

LED E27 4.8W 330°
2700K 470lm EEL=A++
5kWh/1000h
Item no. 560752



LED E27 4.5W 280°
2200-2700K 500lm EEL=A++
5kWh/1000h
Item no. 1002125



Lamp details

max. 60W
Ø: 6.5 cm max. L: 14.5 cm max.

Variant	Item no.
E27	
■ anthracite	1000823



232055 672



1000823 672

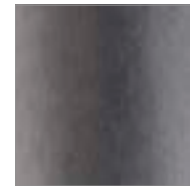

231361 673

LISENNE
CL, E27
 890
E-A++ Range
A++-E

- Basalt and smoked glass

Product details

230V ~50/60Hz
Material: Basalt / Glass



IP 44



2.6



Dimensioned drawing

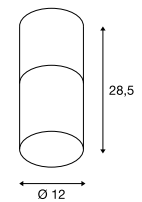

Recommended lamp

LED E27 7.1W 330°
2700K 806lm EEL=A+
8kWh/1000h
Item no. 1001756



Lamp details

max. 23W
Ø: 5.9 cm max. L: 15 cm max.

Variant	Item no.
E27 ■ grey / brown	231361

SITRA
CL, TCR-TSE

896

B-A++

Range
A++-E

Product details

230V ~50Hz
Material: Aluminium / Glass



IP 44

0.66

Dimensioned drawing

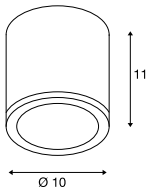

Recommended lamp

GX53 3W 120°
3000K 250lm EEL=A++
3kWh/1000h
Item no. 551372



LED GX53 8.2W 120°
4000K 620lm EEL=A+
9kWh/1000h
Item no. 550074



Lamp details

max. 9W TCR-TSE
Ø: 7.5 cm max. L: 3.5 cm max.

Variant	Item no.
GX53 TCR-TSE	
white	231541
GX53 TCR-TSE	
anthracite	231545



231541

674

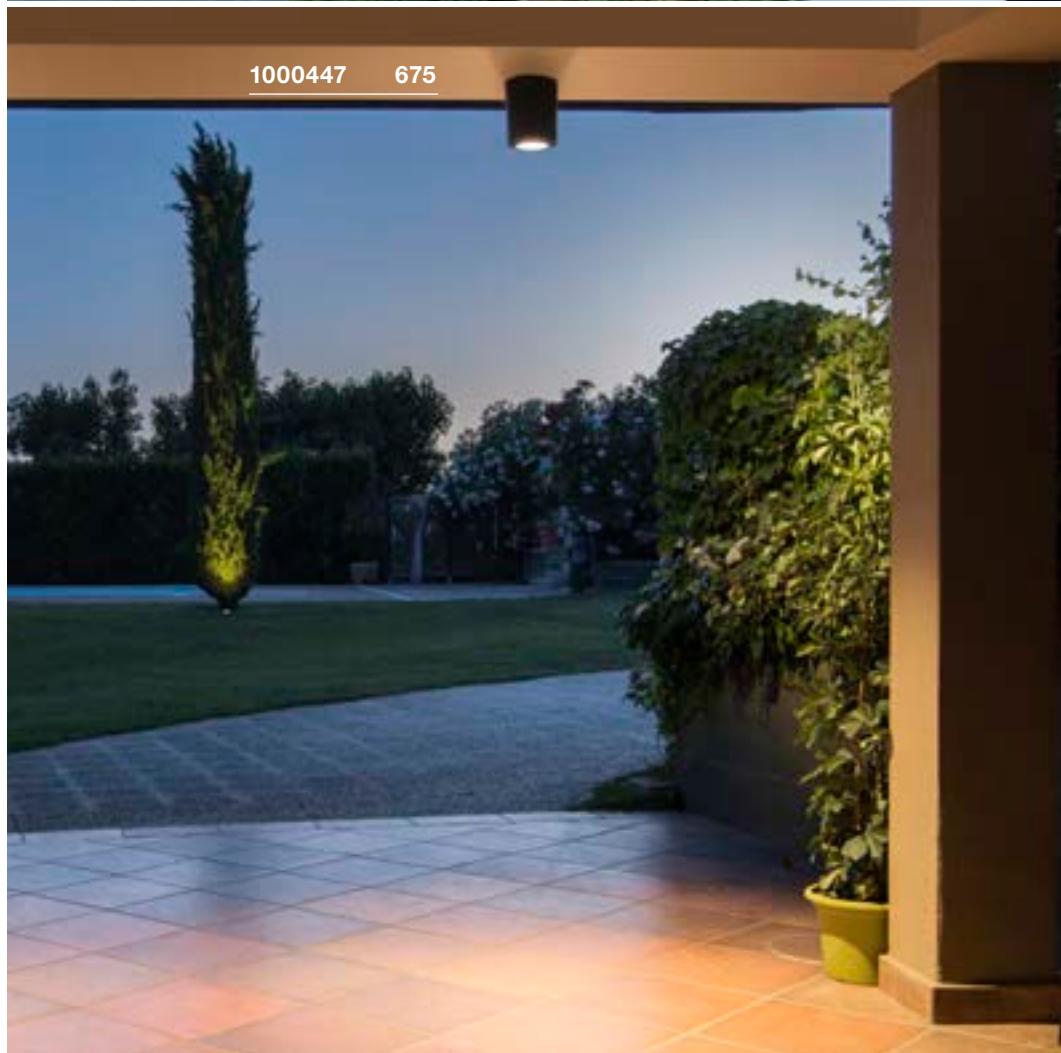

1000447

675

ENOLA C
CL



A-A++ Range A++-E



ENOLA C
CL, TRIAC



A-A++ Range A++-E



POLE PARC
CL



A-A++ Range A++-E



- Premium LED with CRI>90

Product details

100-240V ~50/60Hz | 500mA
Total consumption: 12W
Material: Aluminium / Glass

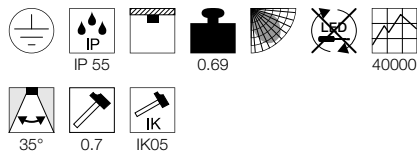

Dimensioned drawing

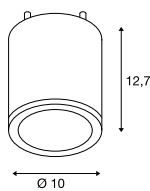

Product details

220-240V ~50/60Hz | 350mA
Total consumption: 15W
Material: Aluminium / Glass
Dimmable: Triac C, Triac L

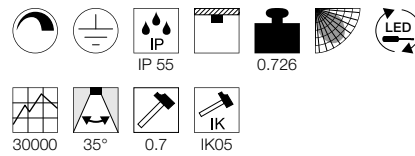

Dimensioned drawing

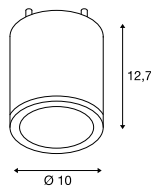

Product details

100-240V ~50/60Hz | 700mA
Total consumption: 28W
Material: Aluminium / Glass

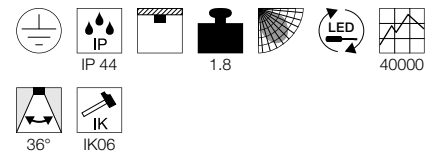

Dimensioned drawing

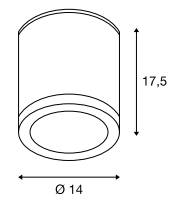

Variant	Item no.
900lm 3000K CRI>80 ■ anthracite	228505

Variant	Item no.
725lm 2000-3000K CRI>90 ■ anthracite	1002154

Variant	Item no.
2900lm 3000K CRI>80 ■ anthracite	1000447

ROX
CL, GX53



B-A++ Range A+-E



- High-quality brushed finis

Product details

230V ~50Hz
Material: Aluminium / Glass

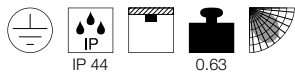

Dimensioned drawing

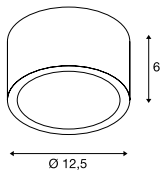

Recommended lamp

GX53 7.5W 25°
3000K 450lm EEL=A
8kWh/1000h
Item no. 550082



LED GX53 7.5W 120°
4000K 620lm EEL=A+
8kWh/1000h
Item no. 1001221



Lamp details

max. 11W TCR-TSE
Ø: 7.5 cm max. L: 3.5 cm max.

Variant	Item no.
GX53 TCR-TSE	
■ matt aluminium	1000339

ROX
CL, QPAR111



E-A++ Range A+-E



- High-quality brushed finis

Product details

230V ~50Hz
Material: Aluminium / Glass

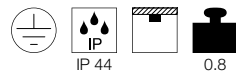

Dimensioned drawing

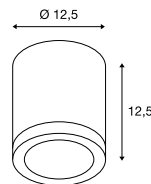

Recommended lamp

GU10 7.9W 25°
2700K 730lm EEL=A+
8kWh/1000h
Item no. 560702



LED GU10 9W 25°
2700-6500K 765lm EEL=A+
9kWh/1000h
Item no. 1001920



Lamp details

max. 50W QPAR111

Variant	Item no.
GU10 QPAR111	
■ brushed aluminium	1000332

ROX ACRYL
CL, E27



A-A++ Range A+-E



- High-quality brushed finis

Product details

230V ~50Hz
Material: Aluminium / Acrylic

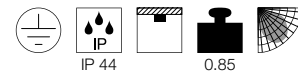

Dimensioned drawing

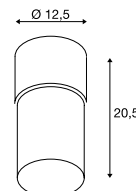

Recommended lamp

LED E27 9.1W 240°
2700K 760lm EEL=A+
10kWh/1000h
Item no. 560402



LED E27 9W 240°
2700-6500K 806lm EEL=A+
9kWh/1000h
Item no. 1001916



Lamp details

max. 20W
Ø: 6 cm max. L: 15 cm max.

Variant	Item no.
E27	
■ matt aluminium	1000338



1000332 676



1000338 676

SQUARE C
CL, E27



A-A++ Range A++-E



Product details

220-240V ~50/60Hz
Material: Stainless Steel 304



Dimensioned drawing

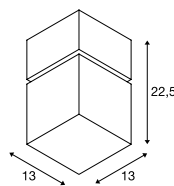

Recommended lamp

LED E27 7W 280°
2700K 790lm EEL=A++
7kWh/1000h
Item no. 1002124



LED E27 9W 240°
3000K 810lm EEL=A+
10kWh/1000h
Item no. 1001031



Lamp details

max. 20W
Ø: 7 cm max. L: 13 cm max.

Variant	Item no.
E27	
■ Stainless steel	1000337

SQUARE
CL, TRIAC



A-A++ Range A++-E



Product details

220-240V ~50/60Hz
Total consumption: 12W
Material: Stainless Steel 316
Dimmable: Triac C, Triac L

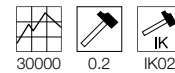
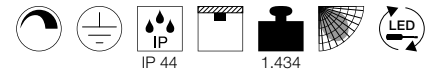

Dimensioned drawing

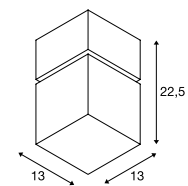

Variant	Item no.
760lm 3000K CRI>80	
■ Stainless steel	1000835

THEO
CL, QPAR51



E-A++ Range A++-E



BIG THEO
CL



A-A++ Range A++-E



BIG THEO
CL, QPAR111



E-A++ Range A++-E



Product details

230V ~50Hz
Material: Aluminium / Glass

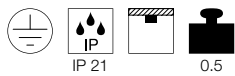

Dimensioned drawing

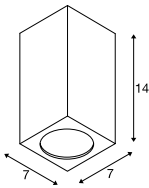

Recommended lamp

LED GU10 7.2W 36°
3000K 520lm EEL=A+
8kWh/1000h
Item no. 1001561



LED GU10 7.2W 36°
4000K 540lm EEL=A+
8kWh/1000h
Item no. 1001564



Lamp details

max. 35W QPAR51
Ø: 5 cm max. L: 6.8 cm max.

Variant	Item no.
GU10 QPAR51 □ white	229581
GU10 QPAR51 ▨ grey / transparent	229584
GU10 QPAR51 ■ anthracite	229585

Product details

100-277V ~50/60Hz | 500mA
Total consumption: 21W
Material: Aluminium / Glass

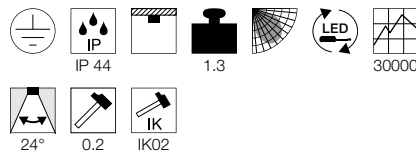

Dimensioned drawing

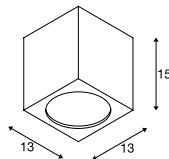

Recommended lamp

GU10 7W 13°
3000K 660lm EEL=A+
8kWh/1000h
Item no. 1001568



LED GU10 7.9W 40°
4000K 760lm EEL=A+
8kWh/1000h
Item no. 560734



Lamp details

max. 75W QPAR111

Variant	Item no.
GU10 QPAR111 □ white	229551
GU10 QPAR111 ▨ grey / transparent	229554
GU10 QPAR111 ■ anthracite	229555



1002157 679



DESIGNED BY
Philippe Stephant *Philippe Stephant*

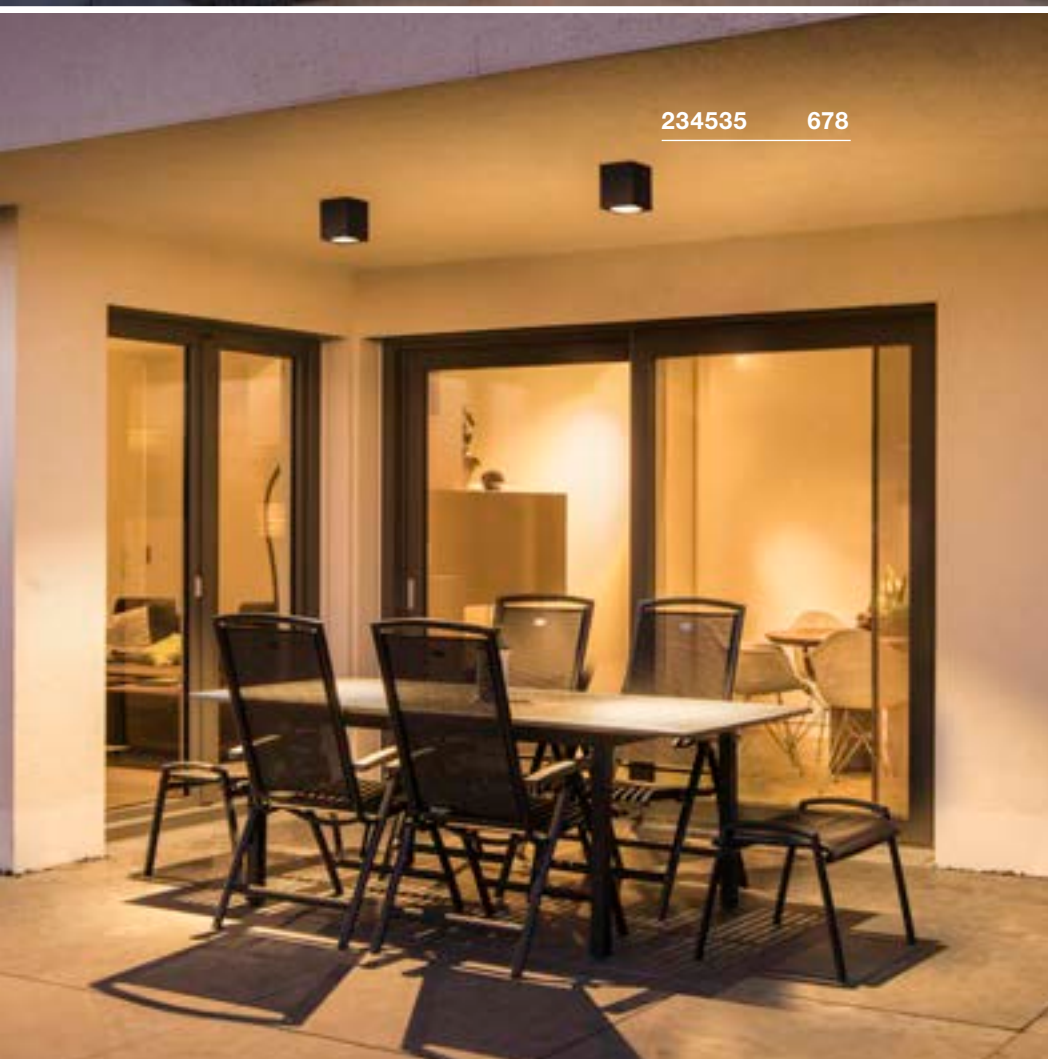

234535 678

MALU
CL

890

A-A++ Range A++-E



- Unusual design
- Homogeneous illumination

Product details

220-240V ~50/60Hz
Total consumption: 9.2W
Material: Aluminium / Glass

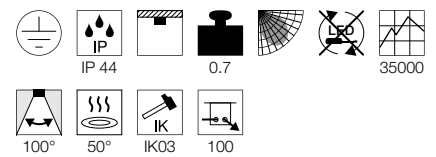

Dimensioned drawing

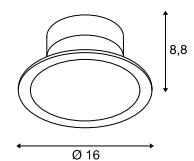

Variant	Item no.
360lm 3000K CRI>80 ■ anthracite	1002157

AINOS
CW



AINOS
CW Sensor



- Motion sensor with microwave technology integrated into the luminaire housing

Product details

100-277V ~50/60Hz | 500mA
Total consumption: 21W
Material: Aluminium / Polycarbonate (PC)

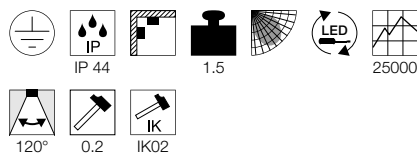

Dimensioned drawing

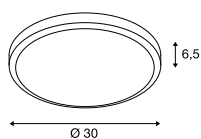

Product details

100-277V ~50/60Hz | 500mA
Total consumption: 22W
Material: Aluminium / Polycarbonate (PC)

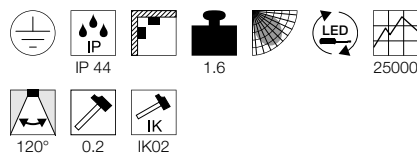

Dimensioned drawing

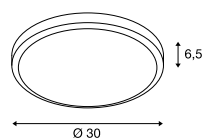

Note

Motion sensor: The detection angle of the sensor is 360°. The detection distance, switch-on ambient brightness and switch-on delay are adjustable.

Variant	Item no.
1430lm 3000K CRI>80	
□ white	229961
1430lm 3000K CRI>80	
■ anthracite	229965

Variant	Item no.
1430lm 3000K CRI>80	
□ white	229971
1430lm 3000K CRI>80	
■ anthracite	229975





1001909/10/11 681

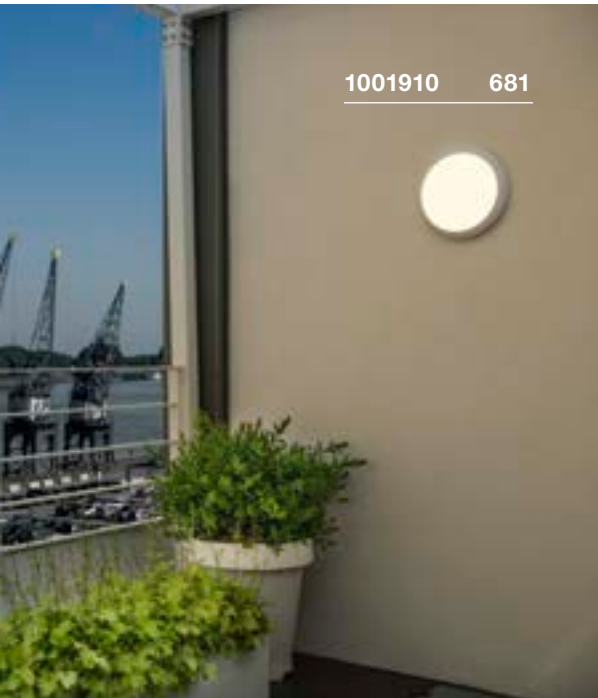

1001910 681

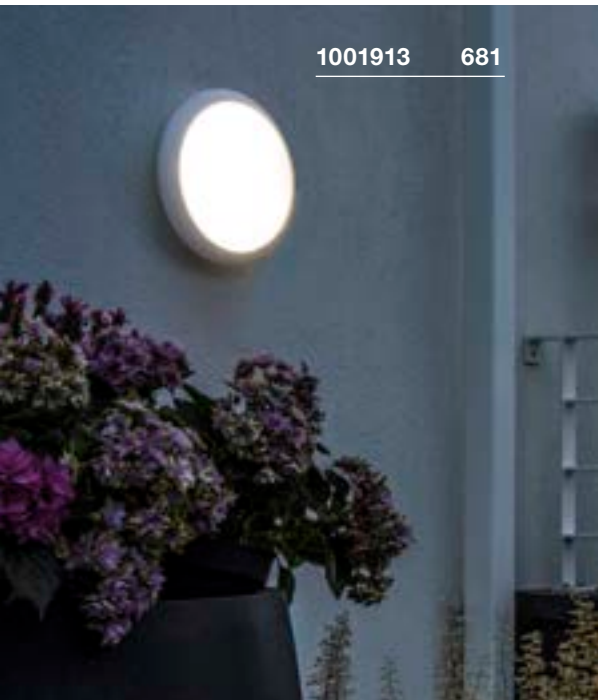

1001913 681

RUBA 10/16/20
CW

A-A++ Range A++-E



- CCT 3000K or 4000K selectable using switch
- The light colour can be set using a switch during installation

Product details

220-240V ~50/60Hz | 600mA
Material: Polycarbonate (PC)

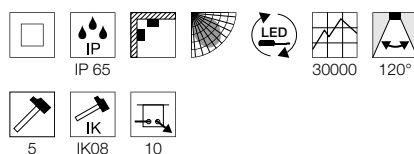

Dimensioned drawing

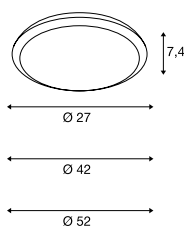

RUBA 10/16/20
CW, Sensor

A-A++ Range A++-E



- CCT 3000K or 4000K selectable using switch
- The light colour can be set using a switch during installation
- Motion sensor with microwave technology integrated into the luminaire housing

Product details

220-240V ~50/60Hz | 700mA
Material: Polycarbonate (PC)

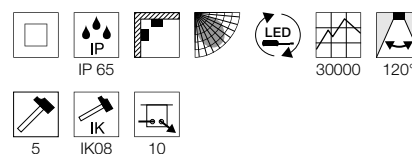

Dimensioned drawing

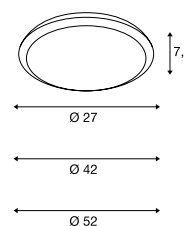

Variant	Item no.
1050lm 3000/4000K CRI>80 13W Ø: 27 cm 0.8 kg □ white	1001909
2230lm 3000/4000K CRI>80 24W Ø: 42 cm 1.1 kg □ white	1001910
2500lm 3000/4000K CRI>80 27W Ø: 52 cm 1.6 kg □ white	1001911

Variant	Item no.
1050lm 3000/4000K CRI>80 13W Ø: 27 cm 0.8 kg □ white	1001912
2230lm 3000/4000K CRI>80 24W Ø: 42 cm 1.1 kg □ white	1001913
2500lm 3000/4000K CRI>80 27W Ø: 52 cm 1.6 kg □ white	1001914

BULAN GRID
CW, E27



• Simple design for a wide range of application areas

Product details

230V ~50Hz
Material: Aluminium / Polycarbonate (PC)

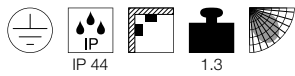

Dimensioned drawing

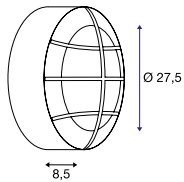

Recommended lamp

E27 9W 240°
3000K 810lm EEL=A+
10kWh/1000h
Item no. 1001031



LED E27 15W 240°
3000K 1521lm EEL=A+
15kWh/1000h
Item no. 1001033



Lamp details

2x max. 25W
Ø: 5.2 cm max. L: 17.3 cm max.

Variant	Item no.
E27	
white	229081
E27	
grey / matt transparent	229084
E27	
anthracite	229085

BULAN
CW, E14

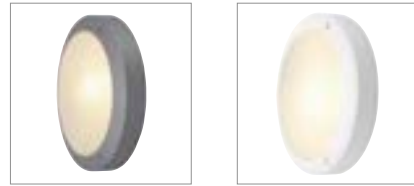

Product details

230V ~50Hz
Material: Aluminium / Glass

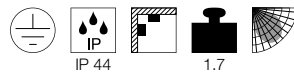

Dimensioned drawing

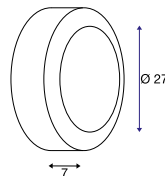

Recommended lamp

LED E14 6.5W 280°
3000K 480lm EEL=A+
7kWh/1000h
Item no. 560372



Lamp details

max. 60W C35
Ø: 4.8 cm max. L: 13 cm max.

Variant	Item no.
E14 C35	
white	229071
E14 C35	
grey / transparent	229072
E14 C35	
anthracite	229075



229087 682



229071 682



LIPA
CW, TRIAC

A-A++ Range A++-E



LED INSIDE



- Colour temperature 3000K or 4000K selectable using switch
- Unusual design

Product details

220-240V ~50/60Hz | 500mA
 Total consumption: 24W
 Material: Aluminium / Polycarbonate (PC)
 Dimmable: Triac C

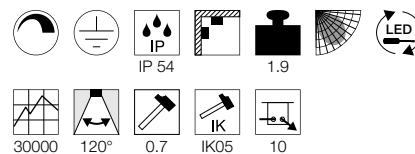

Dimensioned drawing

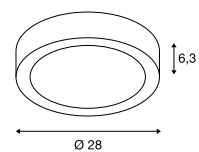

Variant	Item no.
1600lm 3000/4000K CRI>80	
white	1001855
1500lm 3000/4000K CRI>80	
anthracite	1001856

TERANG 200
CW

A-A++ Range A++-E

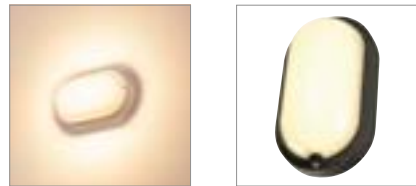
- 240V LED

Product details

220-240V ~50Hz
Total consumption: 11W
Material: Aluminium / Polycarbonate (PC)

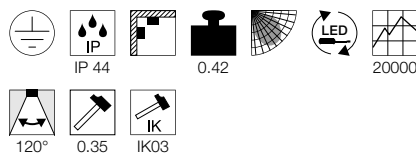

Dimensioned drawing

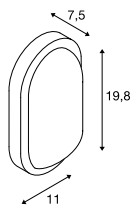

TERANG 270
CW

A-A++ Range A++-E

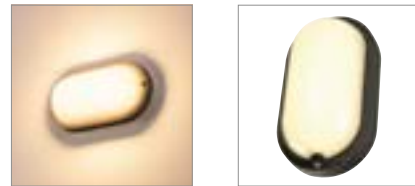
- 240V LED

Product details

220-240V ~50Hz
Total consumption: 22W
Material: Aluminium / Polycarbonate (PC)

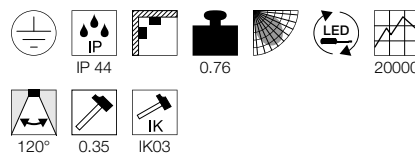

Dimensioned drawing

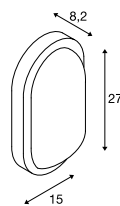

TERANG 270
CW, Sensor

A-A++ Range A++-E



- 240V LED
- Motion sensor with microwave technology integrated in the luminaire housing

Product details

220-240V ~50Hz
Total consumption: 23W
Material: Aluminium / Polycarbonate (PC)

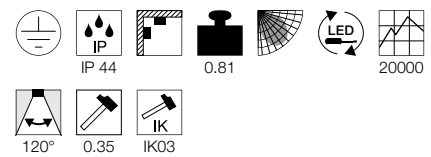

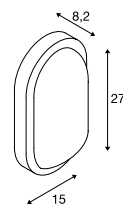
Dimensioned drawing



Note

Motion sensor: The detection angle of the sensor is 360°. The detection distance, switch-on ambient brightness and switch-on delay can be adjusted.

Variant	Item no.
680lm 3000K CRI>80 white	229931
680lm 3000K CRI>80 anthracite	229935

Variant	Item no.
1300lm 3000K CRI>80 white	229941
1300lm 3000K CRI>80 anthracite	229945

Variant	Item no.
1300lm 3000K CRI>80 white	229951
1300lm 3000K CRI>80 anthracite	229955



229955 684

1001316 687



IMPERVA 120 CW

A-A++ Range A++-E
LED INSIDE

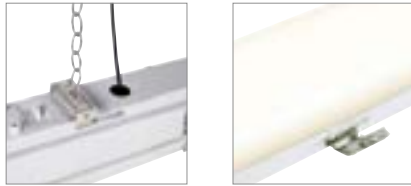

- High IP protection class
- Extremely hard-wearing luminaire housing

Product details

220-240V ~50/60Hz | 700mA
Total consumption: 40W
Material: Polycarbonate (PC)

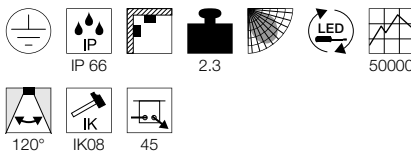

Dimensioned drawing

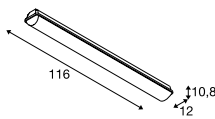

Note

Suspension chain not included

Variant	Item no.
4200lm 3000K CRI>80 ■ grey	1001314
4600lm 4000K CRI>80 ■ grey	1001315

IMPERVA 150 CW

A-A++ Range A++-E
LED INSIDE

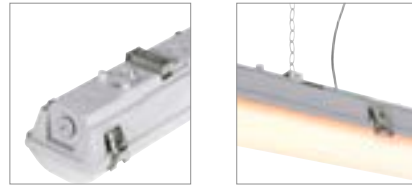

- High IP protection class
- Extremely hard-wearing luminaire housing

Product details

220-240V ~50/60Hz | 1050mA
Total consumption: 55W
Material: Polycarbonate (PC)

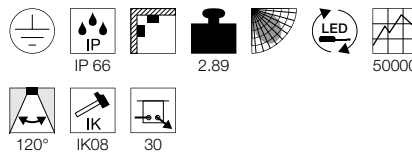

Dimensioned drawing

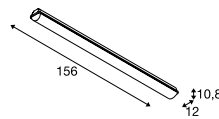

Note

Suspension chain not included

Variant	Item no.
6600lm 3000K CRI>80 ■ grey	1001316
7100lm 4000K CRI>80 ■ grey	1001317

ALMINO PD, quad, UGR<19



A-A++ Range A++-E
LED INSIDE



- Extremely suitable for industrial areas, warehouse and logistical areas
- Efficient basic lighting with limited direct glare, UGR<19
- Extremely hard-wearing housing

Product details

220-240V ~50/60Hz | 1200mA
Total consumption: 190W
Material: Steel / Polycarbonate (PC)

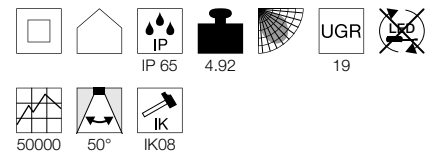

Dimensioned drawing

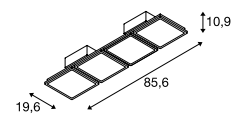

Recommended accessories

- Suspension set 3m
Item no. 1002196
- Installation bracket
Item no. 1002197



Variant	Item no.
24000lm 4000K CRI>80 ■ grey / white	1002194

NAUTILUS 25
CL



892

A-A++ Range
A++-E

NEW



1002867 688



Product details

220-240V ~50/60Hz
Material: Aluminium

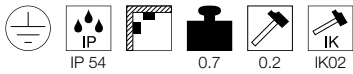

Dimensioned drawing

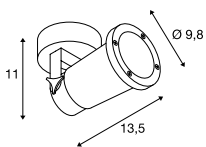

Recommended accessories

■ Installation plate
Item no. 1002884



Lamp details

max. 11W
Ø: 5 cm max. L: 8.3 cm max.

Variant	Item no.
GU10	
■ matt black	1002867

231055 689



NAUTILUS
WL, square



A-A++ Range A++-E



NAUTILUS 10
WL, square



A-A++ Range A++-E



ESKINA SPOT/
SPOT SENSOR
CW



A-A++ Range A++-E



- Switchable light colour
- 1002904 with infrared motion sensor

Product details

100-240V ~50/60Hz | 700mA
Total consumption: 9W
Material: Aluminium / Glass

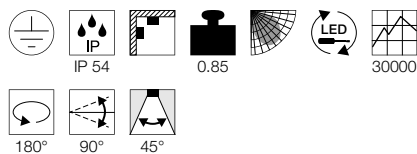

Dimensioned drawing

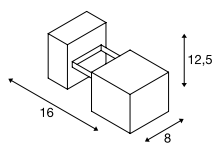

Product details

100-277V ~50/60Hz | 350mA
Total consumption: 17W
Material: Aluminium / Glass

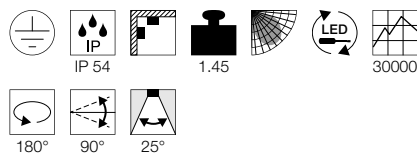

Dimensioned drawing

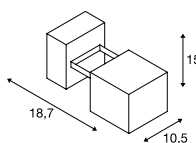

Product details

220-240V ~50/60Hz | 350mA
Total consumption: 14.5W
Material: Aluminium
Dimmable: Triac C

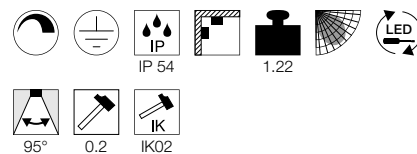

Dimensioned drawing

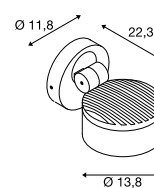

Note

Item no. 1002904 – Motion sensor: Detection angle: 100° detection distance: max. 10 m
The switch-on ambient brightness and switch-on delay can be adjusted.

Variant	Item no.
520lm 3000K CRI>80 ■ anthracite	231045

Variant	Item no.
950lm 3000K CRI>80 ■ anthracite	231055

Variant	Item no.
1000lm 3000/4000K CRI>80 ■ matt anthracite	1002903
1000lm 3000/4000K CRI>80 ■ matt anthracite	1002904

SITRA 360
CW, TCR-TSE



B-A++ Range A++-E



MYRA
CW, single, QPAR51



E-A++ Range A++-E

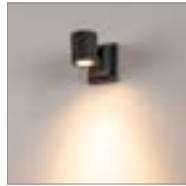

MYRA
WL, double, QPAR51



E-A++ Range A++-E

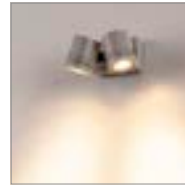

Product details

230V ~50Hz
Material: Aluminium / Glass

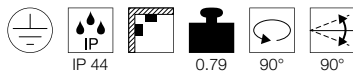

Dimensioned drawing

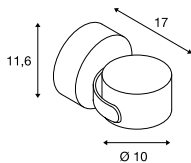

Product details

230V ~50Hz
Material: Aluminium / Glass

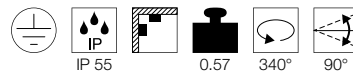

Dimensioned drawing

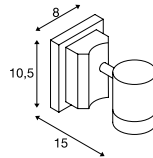

Product details

220-240V ~50/60Hz
Material: Aluminium / Glass

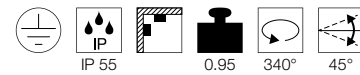

Dimensioned drawing

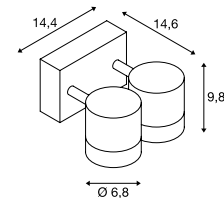

Note

Adapter frame available for surface mounting

Recommended accessories

Frame for surface mounting

Item no. 233214

Frame for surface mounting

Item no. 233215

Recommended lamp

GX53 3W 120°
3000K 250lm EEL=A++
3kWh/1000h
Item no. 551372



LED GX53 8.2W 120°
4000K 620lm EEL=A+
9kWh/1000h
Item no. 550074



Lamp details

max. 9W TCR-TSE
Ø: 7.5 cm max. L: 3.5 cm max.

Variant	Item no.
GX53 TCR-TSE	
■ anthracite	231515

Recommended lamp

LED GU10 7.2W 36°
4000K 540lm EEL=A+
8kWh/1000h
Item no. 1001565



LED GU10 7.2W 36°
2700K 520lm EEL=A+
8kWh/1000h
Item no. 1001560



Lamp details

max. 50W QPAR51
Ø: 5 cm max. L: 5.7 cm max.

Variant	Item no.
GU10 QPAR51	
■ grey / transparent	233104
GU10 QPAR51	
■ anthracite	233105

Recommended lamp

LED GU10 5.5W 38°
2700K 400lm EEL=A+
6kWh/1000h
Item no. 1001030



LED GU10 7.2W 36°
3000K 520lm EEL=A+
8kWh/1000h
Item no. 1001562



Lamp details

2x max. 50W QPAR51
Ø: 5 cm max. L: 5.7 cm max.

Variant	Item no.
GU10 QPAR51	
■ grey / transparent	233094
GU10 QPAR51	
■ anthracite	233095



233104 690

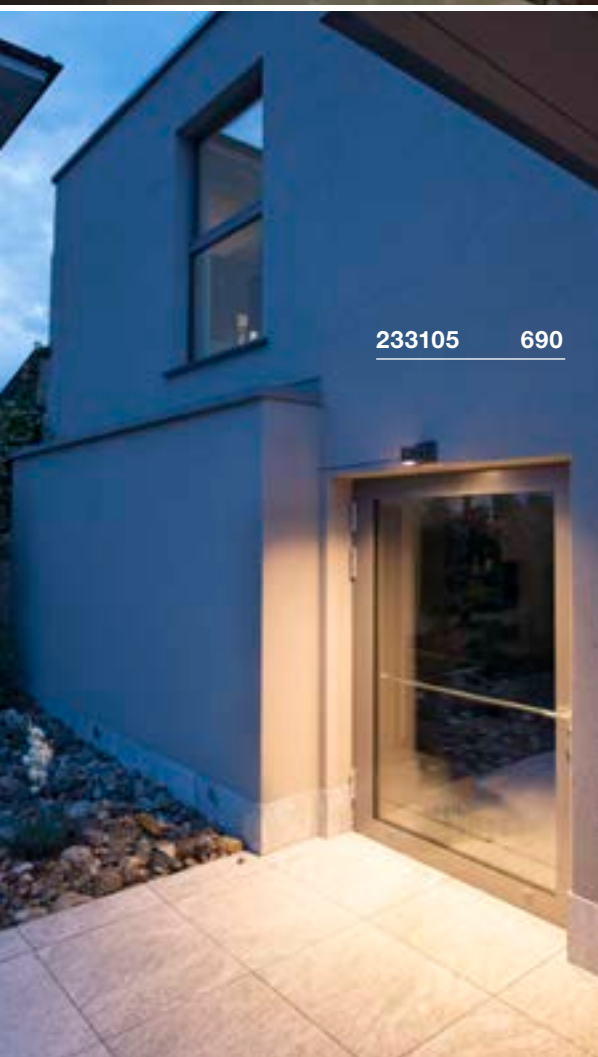

233105 690

HELIA
CW, single, TRIAC



A-A++ Range A++-E

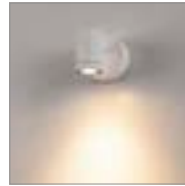

• 240V LED

Product details

220-240V ~50/60Hz
Total consumption: 8W
Material: Aluminium / Glass
Dimmable: Triac C, Triac L

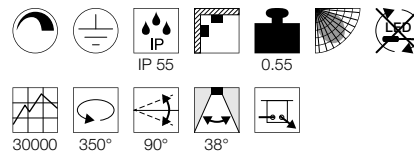

Dimensioned drawing

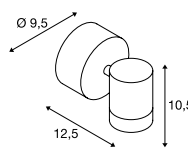

Variant	Item no.
450lm 3000K CRI>80	
■ anthracite	233245
450lm 3000K CRI>80	
□ white	233241

HELIA
CW, double, TRIAC



A-A++ Range A++-E

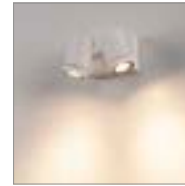

• 240V LED

Product details

220-240V ~50/60Hz
Total consumption: 16W
Material: Aluminium / Glass
Dimmable: Triac C, Triac L

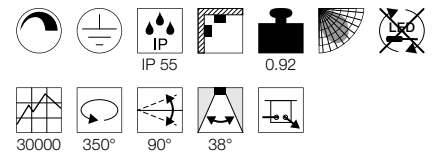

Dimensioned drawing

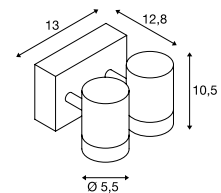

Variant	Item no.
900lm 3000K CRI>80	
■ anthracite	233255
900lm 3000K CRI>80	
□ white	233251

TOUGH COOKIE.

RECESSED FITTINGS – THE RELIABLE WAY OF LIGHTING.

Recessed fittings are a good alternative to suspended luminaires, particularly in the outdoor area, since they are individually adjustable and can be set, directed and flooded statically. And they are equipped to cope with any weather. Thanks to high-quality workmanship and materials and individual IP protection classes.

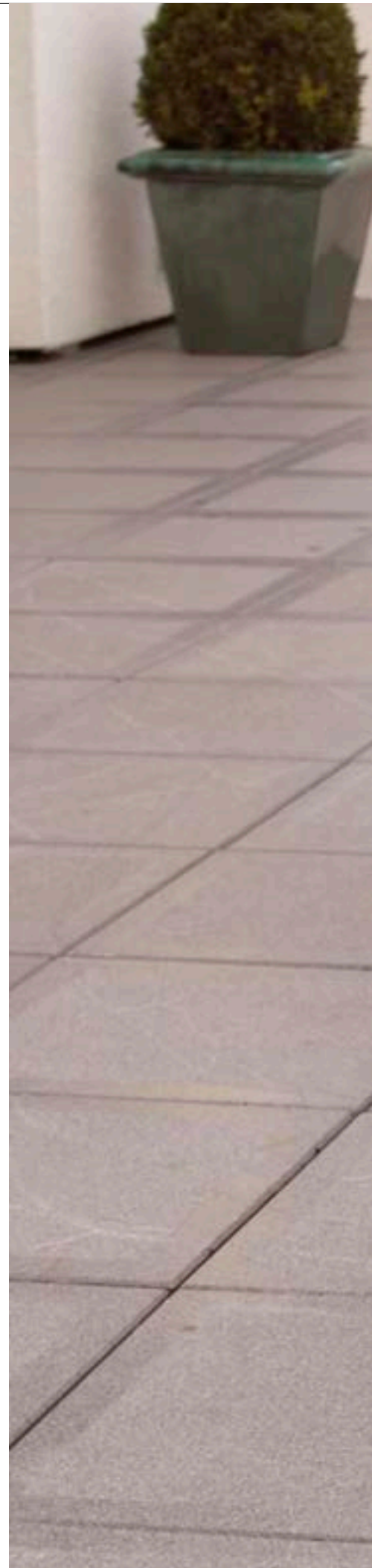



228412 722



227604 719



RECESSED FITTING



 Other luminaires and variants can be found online at www.slv.com

RECESSED WALL LIGHTS

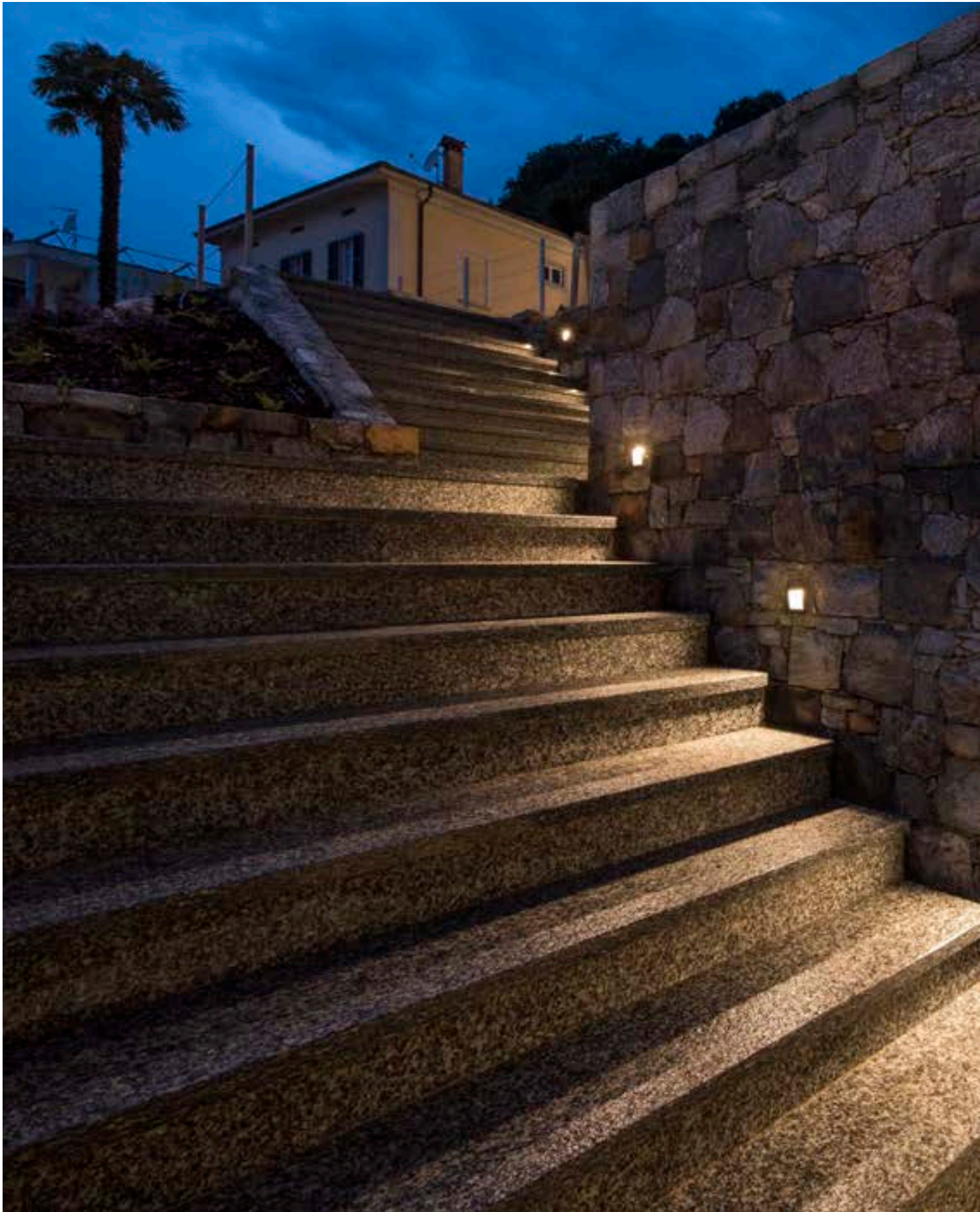

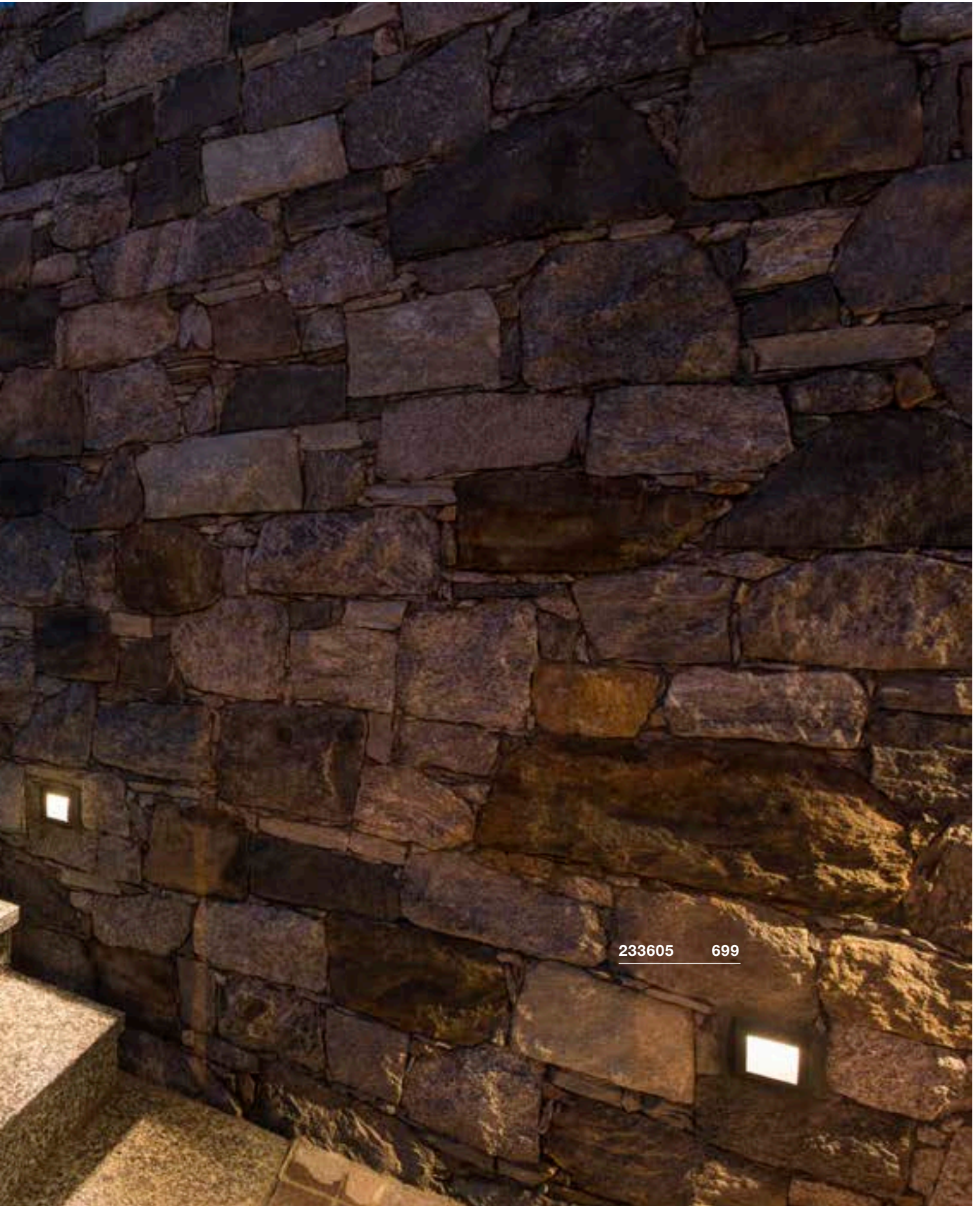

233605 699

BRICK DOWNUNDER
EL, E14

E-A++ Range A++-E



BRICK DOWNUNDER
EL

A-A++ Range A++-E



Product details

230V ~50Hz
Material: Aluminium / Glass

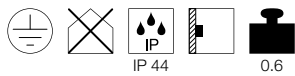

Product details

230V ~50Hz
Total consumption: 1.4W
Material: Aluminium / Glass

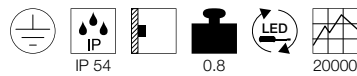

Dimensioned drawing

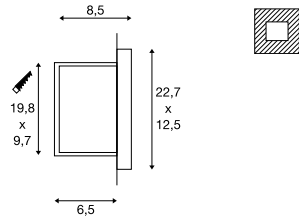

Note

No mounting pot needed.

Dimensioned drawing

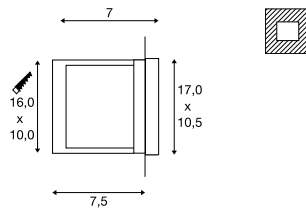

Note

Mounting pot incl.

Recommended lamp

E14 3.4W 260°
3000K 250lm EEL=A+
4kWh/1000h
Item no. 560362



LED E14 6.5W 280°
3000K 480lm EEL=A+
7kWh/1000h
Item no. 560372



Lamp details

max. 40W C35
Ø: 4.3 cm max. L: 12 cm max.

Variant	Item no.
E14 C35 grey / transparent	229062

Variant	Item no.
30lm 3000K CRI>80 grey / transparent	229702

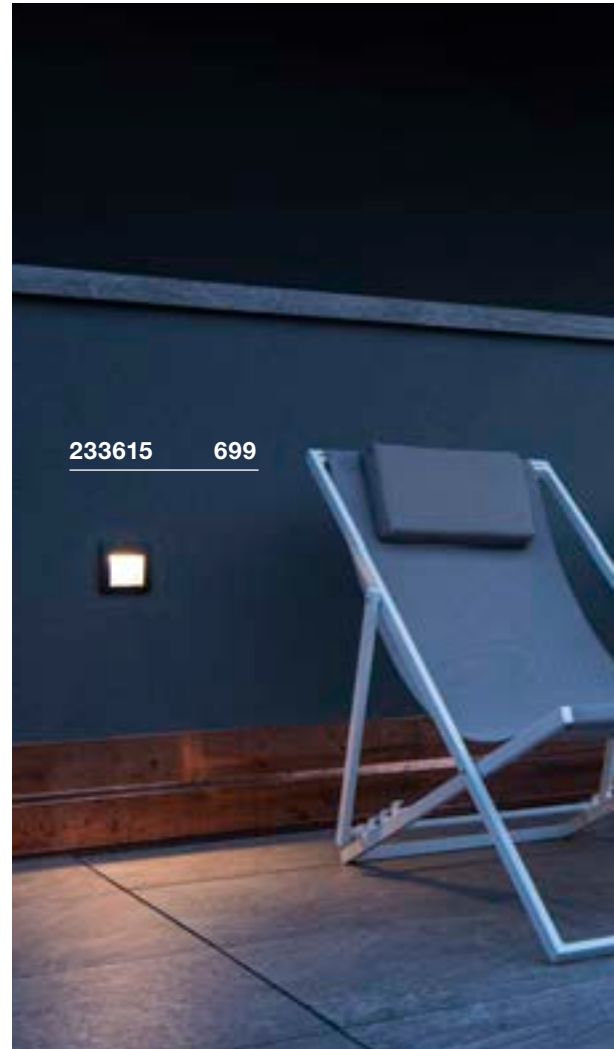



DOWNUNDER OUT S EL

A-A++ Range A++-E

LED INSIDE



Product details

220-240V ~50/60Hz | 20mA
 Total consumption: 1.7W
 Material: Aluminium / Plastic



Dimensioned drawing

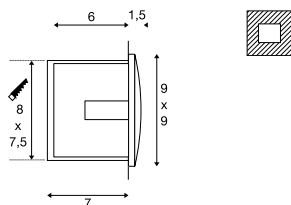

Note

Always install the luminaires with the light outlet pointing downwards. Max. connecting cable diameter 8.5 mm. Mounting pot incl.

DOWNUNDER OUT M EL

A-A++ Range A++-E

LED INSIDE



Product details

220-240V ~50/60Hz | 20mA
 Total consumption: 3.3W
 Material: Aluminium / Plastic



Dimensioned drawing

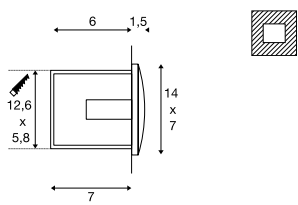

Note

Always install the luminaires with the light outlet pointing downwards. Max. connecting cable diameter 8.5 mm. Mounting pot incl.

DOWNUNDER OUT L EL

A-A++ Range A++-E

LED INSIDE



Product details

220-240V ~50/60Hz | 20mA
 Total consumption: 3.3W
 Material: Aluminium / Plastic



Dimensioned drawing

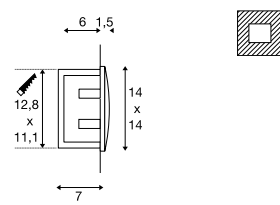

Note

Always install the luminaires with the light outlet pointing downwards. Max. connecting cable diameter 8.5 mm. Mounting pot incl.

Variant	Item no.
40lm 3000K CRI>80	
□ white	233601
25lm 3000K CRI>80	
■ anthracite	233605

Variant	Item no.
155lm 3000K CRI>80	
□ white	233621
85lm 3000K CRI>80	
■ anthracite	233625

Variant	Item no.
155lm 3000K CRI>80	
□ white	233611
85lm 3000K CRI>80	
■ anthracite	233615

ADI
EL

A-A++ Range A++-E

LED
INSIDE



Product details

100-277V ~50/60Hz | 500mA
Total consumption: 18W
Material: Aluminium / Polycarbonate (PC)

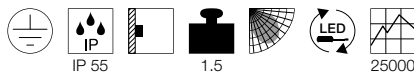

Dimensioned drawing

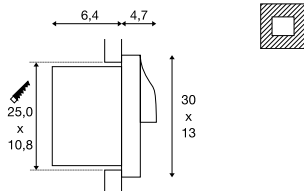

Note

Always install the luminaires with the light outlet pointing downwards.

Recommended accessories

■ Mounting pot
Item no. 233639

Variant	Item no.
870lm 3000K CRI>80 ■ anthracite	233635





BRICK MESH
EL

A-A++ Range A++-E

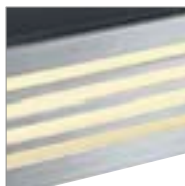

- Panel: Stainless Steel 316

Product details

100-240V ~50/60Hz | 24V DC
Total consumption: 3.7W
Material: Stainless Steel 316 / Glass



Dimensioned drawing

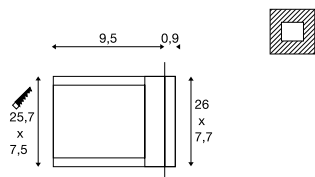

Note

Mounting pot incl.

BRICK
EL, symmetrical

A-A++ Range A++-E



- Symmetrical light emission
- Panel stainless steel 316L, housing aluminium

Product details

220-240V ~50/60Hz | 700mA
Total consumption: 11W
Material: Aluminium / Stainless Steel 316



Dimensioned drawing

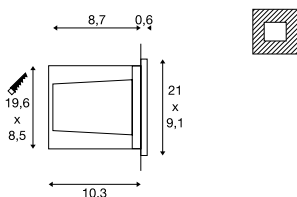

Note

Mounting pot incl.

BRICK
EL, asymmetrical

A-A++ Range A++-E

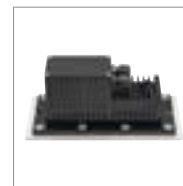

- Asymmetrical light emission
- Panel stainless steel 316L, housing aluminium

Product details

220-240V ~50/60Hz | 700mA
Total consumption: 11W
Material: Aluminium / Stainless Steel 316



Dimensioned drawing

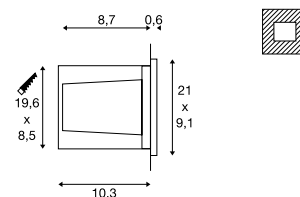

Note

Mounting pot incl.

Variant	Item no.
52lm 3000K CRI>80 ■ stainless steel	229110

Variant	Item no.
950lm 3000K CRI>80 ■ stainless steel	233650

Variant	Item no.
850lm 3000K CRI>80 ■ stainless steel	233660



RECESSED CEILING LIGHTS

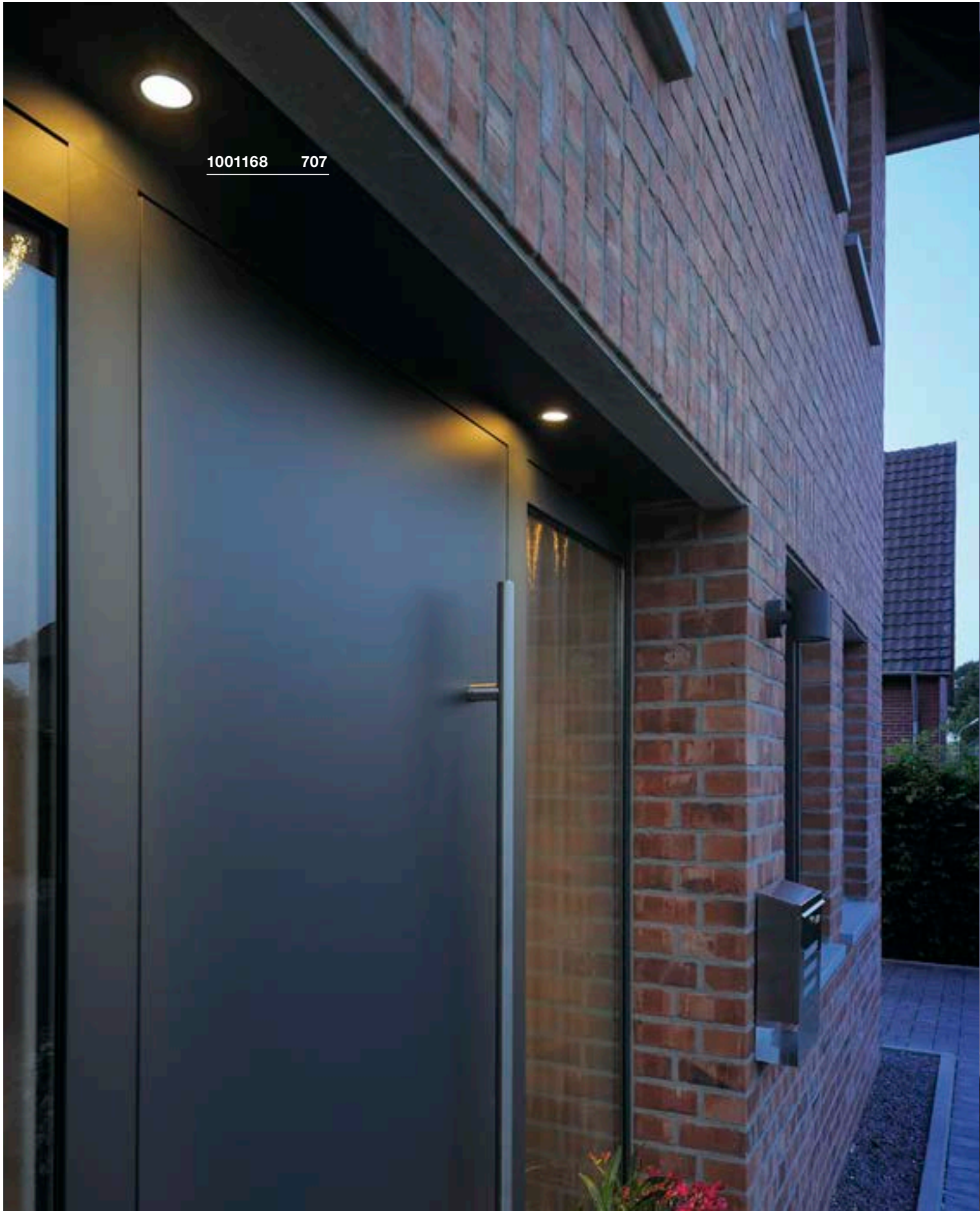

1001168 707

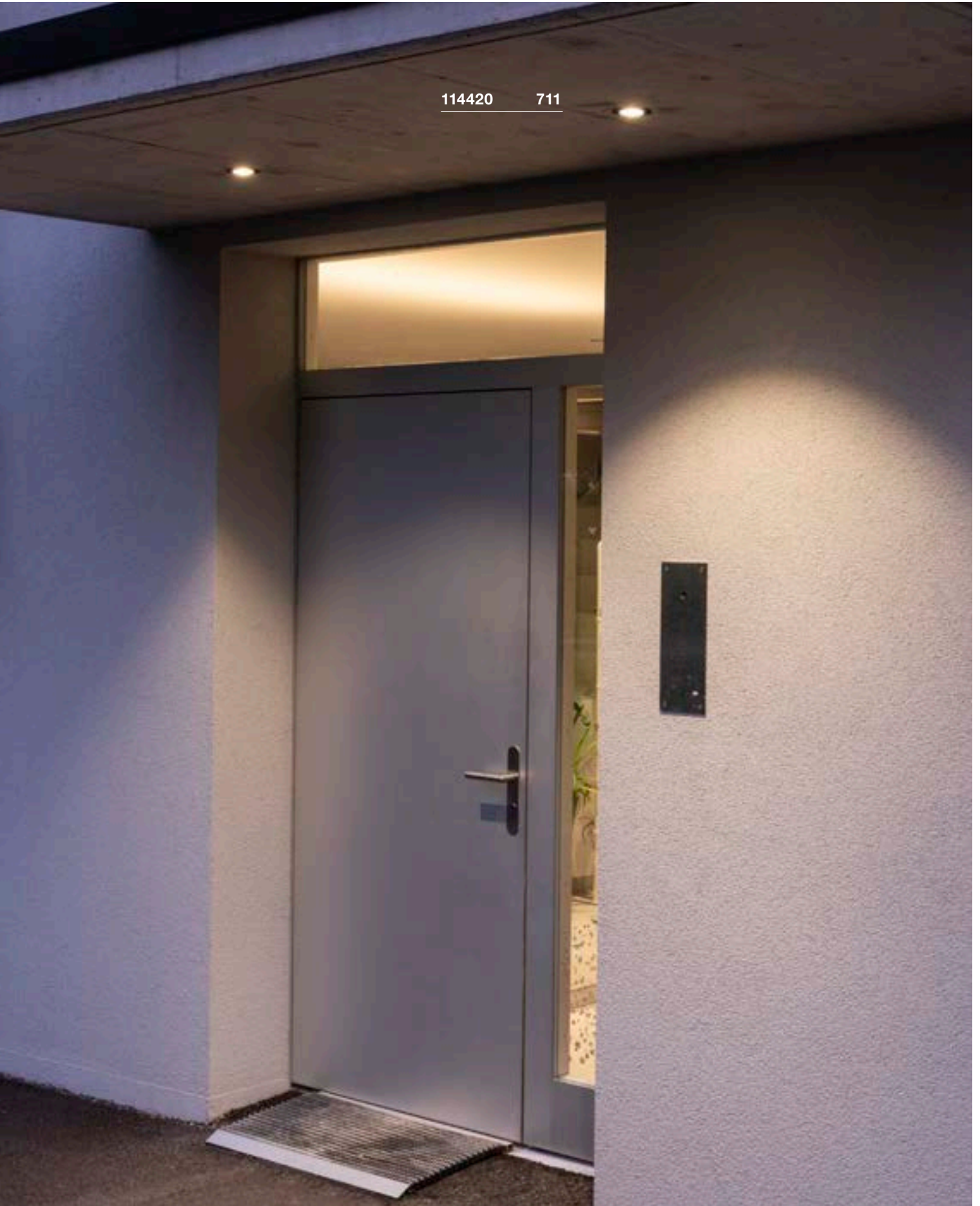

114420 711

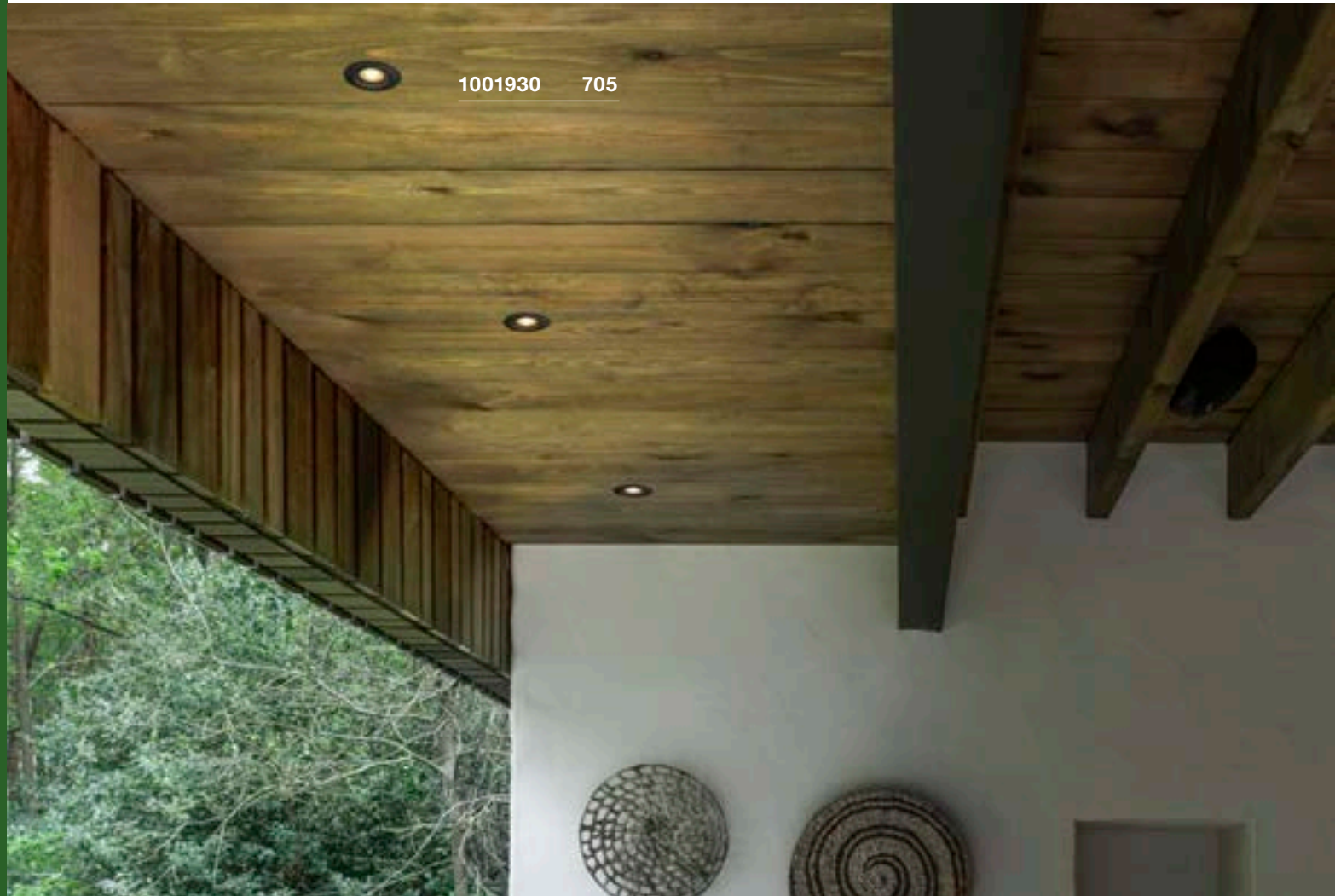
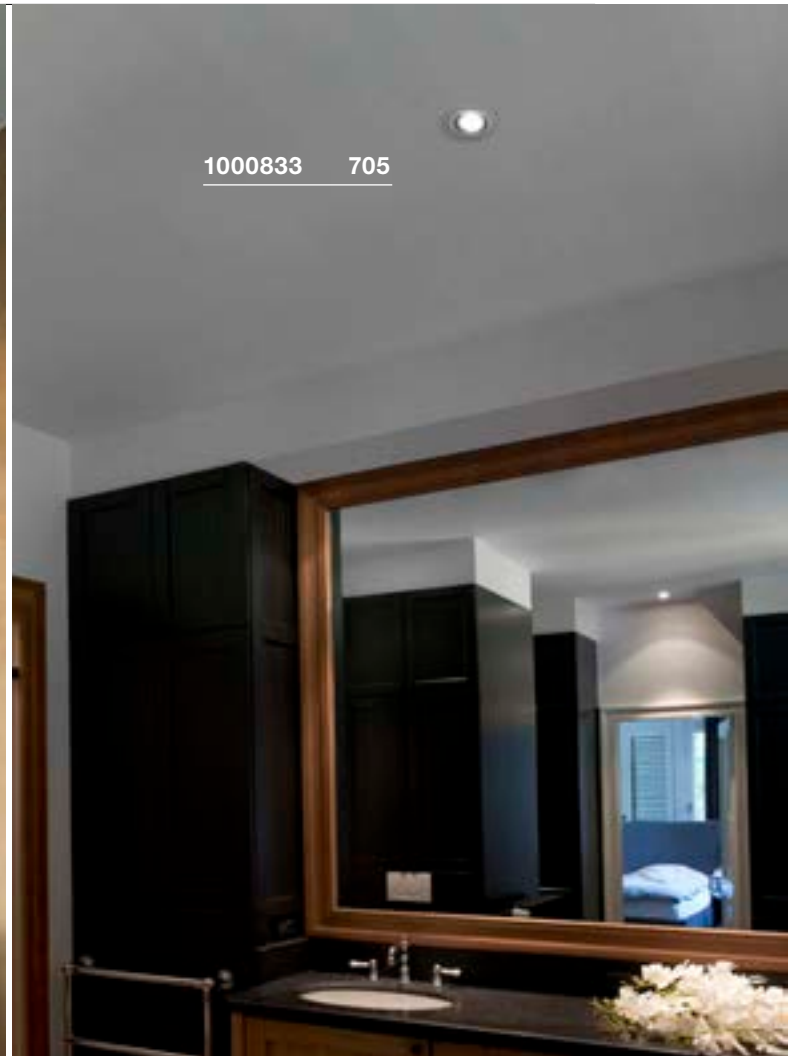

VARU
EL, QPAR51

A-A++ Range A++-E



- High IP protection class
- Resistant housing

Product details

230V-50Hz
Material: Aluminium / Glass

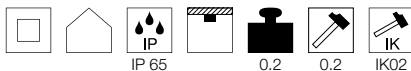

Dimensioned drawing

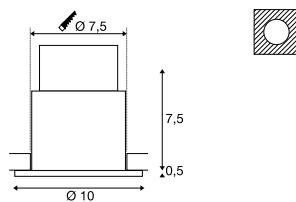

Note

Material thickness, mounting surface: 15 mm

Recommended lamp

GU10 5.5W 36°
2800K 420lm EEL=A+
6kWh/1000h
Item no. 1001217



LED GU10 7.2W 36°
2700K 520lm EEL=A+
8kWh/1000h
Item no. 1001560



Lamp details

max. 5W LED GU10 51 mm
Ø: 5 cm max. L: 4.6 cm max.

Variant	Item no.
GU10 LED GU10 51mm	
■ black	1001930
GU10 LED GU10 51mm	
□ white/black	1001931

VARU
EL

A-A++ Range A++-E



- High IP protection class
- Resistant housing
- Reduced glare due to set-back LED

Product details

350mA | 5W
Material: Aluminium / Glass

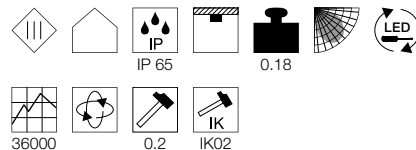

Dimensioned drawing

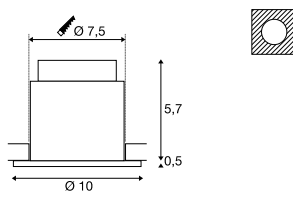

Note

Material thickness, mounting surface: 15 mm

Recommended accessories

- LED driver 350mA | 9W
Item no. 464109
- Honeycomb fil er
Item no. 1001934



Variant	Item no.
400lm 2700K CRI>80	
■ black	1001932
400lm 2700K CRI>80	
□ white/black	1001933

KINI
EL, TRIAC

A-A++ Range A++-E



- High IP protection class
- Suitable for wet rooms
- Tiltable

Product details

220-240V ~50/60Hz | 260mA
Total consumption: 12W
Material: Aluminium / Polycarbonate (PC)
Dimmable: Triac C, Triac L

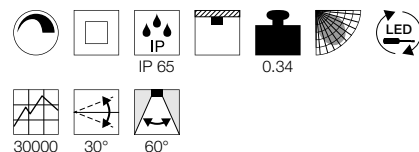

Dimensioned drawing

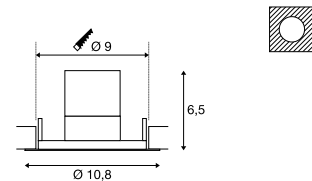

Note

Material thickness, mounting surface: 5-20 mm

Variant	Item no.
850lm 3000K CRI>80	
□ white	1000833

DOLIX OUT
EL, round, QR-C51



DOLIX OUT
EL, square, QR-C51



1001157 706

Product details

12V ~50Hz
Material: Aluminium / Glass

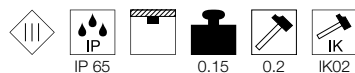

Dimensioned drawing

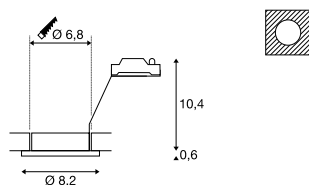

Note

Material thickness, mounting surface: 20 mm

Product details

12V ~50Hz
Material: Aluminium / Glass

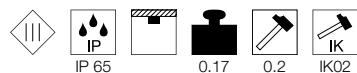

Dimensioned drawing

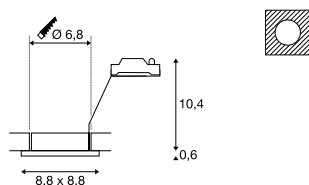

Note

Material thickness, mounting surface: 20 mm

Recommended lamp

LED GU5.3 5.5W 36°
2700K 450lm EEL=A+
7kWh/1000h
Item no. 1001574



Lamp details

max. 50W QR-C51

Variant	Item no.
GX5.3 QR-C51	
<input type="checkbox"/> white	1001157

Recommended lamp

LED GU5.3 5.5W 36°
2700K 450lm EEL=A+
7kWh/1000h
Item no. 1001574



Lamp details

max. 50W QR-C51

Variant	Item no.
GX5.3 QR-C51	
<input type="checkbox"/> white	1001161



1001167 707

DOLIX OUT
EL, round, QPAR51

E-A++ Range A++-E



Product details

220-240V ~50/60Hz
Material: Aluminium / Glass

Dimensioned drawing

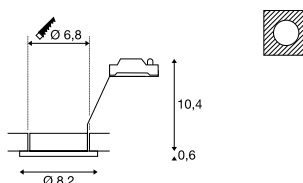

Note

Material thickness, mounting surface: 20 mm

Recommended lamp

LED GU10 5.5W 38°
2700K 400lm EEL=A+
6kWh/1000h

Item no. 1001030

LED GU10 7.2W 36°
3000K 520lm EEL=A+
8kWh/1000h

Item no. 1001562

Lamp details

max. 50W QPAR51

Variant	Item no.
GU10 QPAR51	
white	1001165
GU10 QPAR51	
chrome	1001166
GU10 QPAR51	
grey / transparent	1001167
GU10 QPAR51	
chrome	1001168

DOLIX OUT
EL, square, QPAR51

E-A++ Range A++-E



Product details

220-240V ~50/60Hz
Material: Aluminium / Glass

Dimensioned drawing

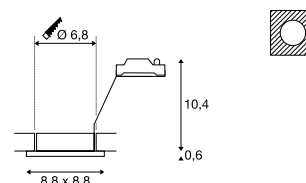

Note

Material thickness, mounting surface: 20 mm

Recommended lamp

LED GU10 5.5W 38°
2700K 400lm EEL=A+
6kWh/1000h

Item no. 1001030

LED GU10 7.2W 36°
3000K 520lm EEL=A+
8kWh/1000h

Item no. 1001562

Lamp details

max. 50W QPAR51

Variant	Item no.
GU10 QPAR51	
white	1001169
GU10 QPAR51	
chrome	1001170
GU10 QPAR51	
grey / transparent	1001171
GU10 QPAR51	
chrome	1001172

OUT 65
EL, round, TRIAC

A-A++ Range A++-E

LED INSIDE



• High IP protection class

OUT 65
EL, square, TRIAC

A-A++ Range A++-E

LED INSIDE



• High IP protection class

Product details

220-240V ~50/60Hz | 500mA
Total consumption: 11W
Material: Aluminium / Glass
Dimmable: Triac C, Triac L

40000 38°

Dimensioned drawing

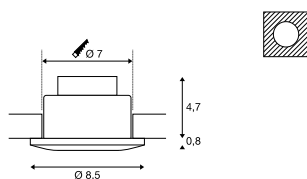

Note

Material thickness, mounting surface: 20 mm

Product details

220-240V ~50/60Hz | 500mA
Total consumption: 11W
Material: Aluminium / Glass
Dimmable: Triac C, Triac L

40000 38°

Dimensioned drawing

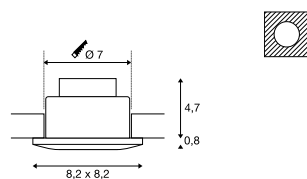

Note

Material thickness, mounting surface: 20 mm

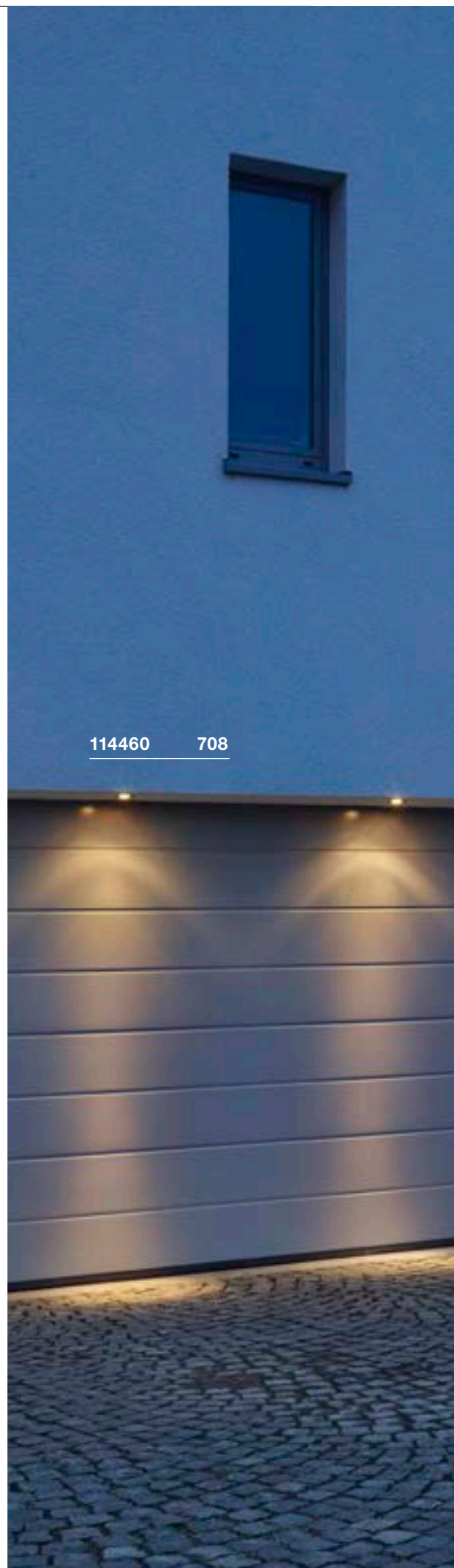

114460 708

Variant	Item no.
510lm 3000K CRI>80	
■ black	114460
640lm 3000K CRI>80	
□ white	114461

Variant	Item no.
510lm 3000K CRI>80	
■ black	114470
640lm 3000K CRI>80	
□ white	114471

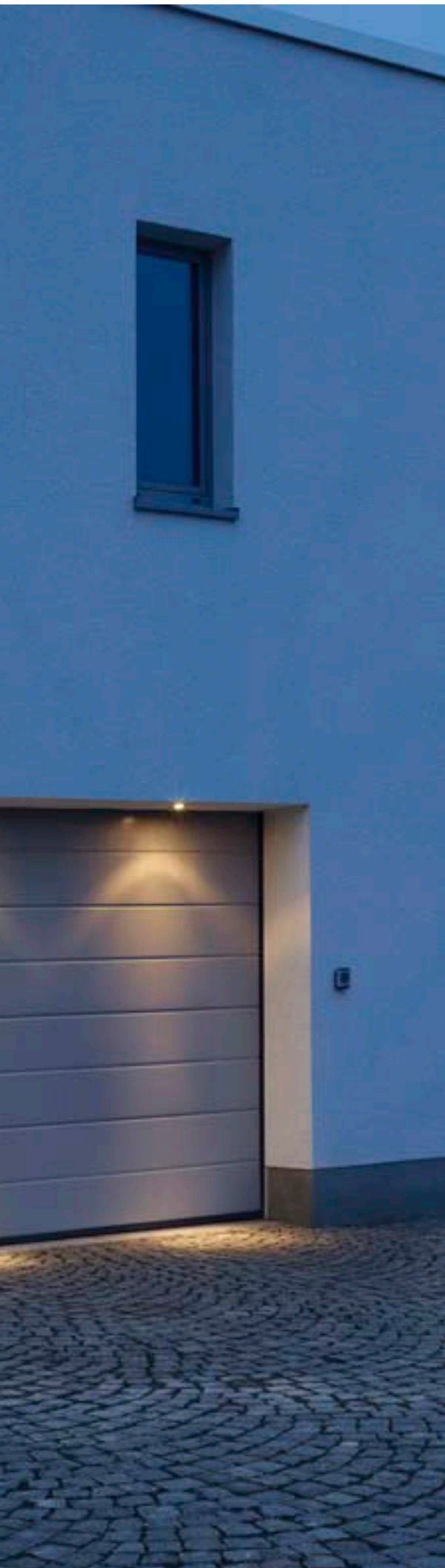

PATTA-F
EL, round, TRIAC

A-A++ Range A++-E

LED INSIDE

Home icon with plus sign



- High IP protection class

Product details

220-240V ~50/60Hz | 500mA
 Total consumption: 11W
 Material: Aluminium / Glass
 Dimmable: Triac C, Triac L

Icons: Beam spread, Square, IP 65, Glass, Mounting, Fan, LED, Dimmer

40000 38°

Dimensioned drawing

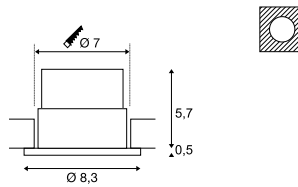

Note

Material thickness, mounting surface: 20 mm

PATTA-F
EL, square, TRIAC

A-A++ Range A++-E

LED INSIDE

Home icon with plus sign

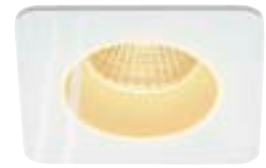

- High IP protection class

Product details

220-240V ~50/60Hz | 500mA
 Total consumption: 11W
 Material: Aluminium / Glass
 Dimmable: Triac C, Triac L

Icons: Beam spread, Square, IP 65, Glass, Mounting, Fan, LED, Dimmer

40000 38°

Dimensioned drawing

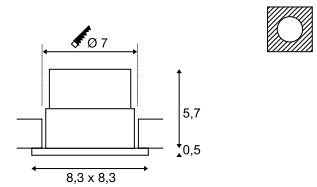

Note

Material thickness, mounting surface: 20 mm

Variant	Item no.
745lm 3000K CRI>80	
■ black	114440
860lm 3000K CRI>80	
□ white	114441

Variant	Item no.
745lm 3000K CRI>80	
■ black	114450
860lm 3000K CRI>80	
□ white	114451

PATTA-I
EL, round, TRIAC



- Premium LED with CRI>90
- Dim to Warm (1800-3000K)
- High IP protection class

Product details

220-240V ~50/60Hz | 350mA
Total consumption: 7.3W
Material: Aluminium / Glass
Dimmable: Triac C, Triac L

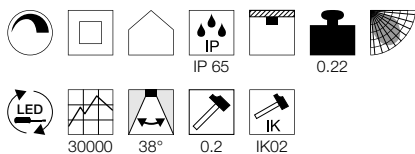

Dimensioned drawing

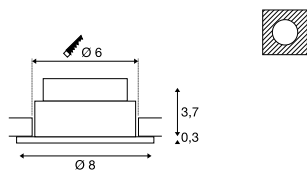

Note

Products supplied with clip springs. Leaf springs included with the product and can be exchanged. Material thickness, mounting surface: 20 mm

PATTA-I
EL, square, TRIAC

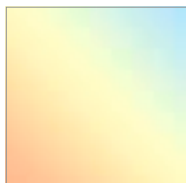

- Premium LED with CRI>90
- Dim to Warm (1800-3000K)
- High IP protection class

Product details

220-240V ~50/60Hz | 350mA
Total consumption: 7.3W
Material: Aluminium / Glass
Dimmable: Triac C, Triac L

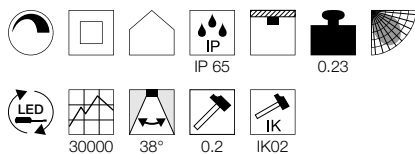

Dimensioned drawing

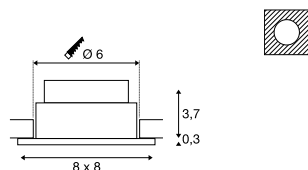

Note

Products supplied with clip springs. Leaf springs included with the product and can be exchanged. Material thickness, mounting surface: 20 mm

Variant	Item no.
440lm 1800-3000K CRI>95	
■ black	1002098
440lm 1800-3000K CRI>95	
□ matt white	1002099
440lm 1800-3000K CRI>95	
■ matt aluminium	1002100

Variant	Item no.
440lm 1800-3000K CRI95	
■ black	1002101
440lm 1800-3000K CRI95	
□ matt white	1002102
440lm 1800-3000K CRI95	
■ matt aluminium	1002103



PATTA-I
EL, round, TRIAC

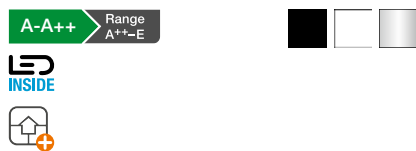

- High IP protection class

Product details

220-240V ~50/60Hz | 500mA
Total consumption: 11W
Material: Aluminium / Glass
Dimmable: Triac C, Triac L

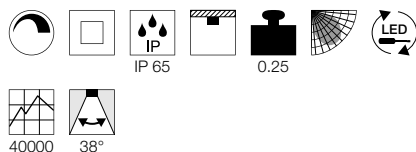

Dimensioned drawing

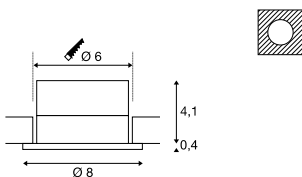

Note

Material thickness, mounting surface: 25 mm

PATTA-I
EL, square, TRIAC



- High IP protection class

Product details

220-240V ~50/60Hz | 500mA
Total consumption: 11W
Material: Aluminium / Glass
Dimmable: Triac C, Triac L

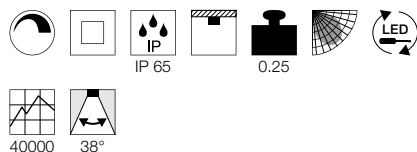

Dimensioned drawing

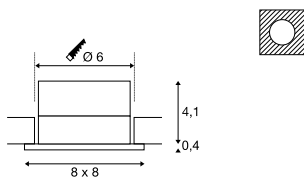

Note

Material thickness, mounting surface: 25 mm

KAMUELA ECO
EL, round, TRIAC



- Fire-resistant for at least 90 minutes in accordance with BS 476-21
- IP 65 luminaire with efficient LED technology

Product details

220-240V ~50Hz
Total consumption: 6.5W
Material: Aluminium / Plastic
Dimmable: Triac C, Triac L

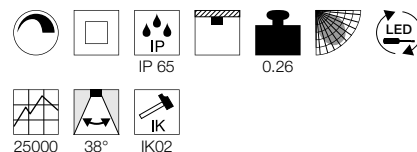

Dimensioned drawing

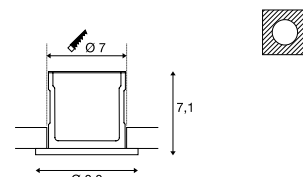

Note

Material thickness, mounting surface: 40 mm max.

Variant	Item no.
910lm 3000K CRI>80	
■ matt black	114420
910lm 3000K CRI>80	
□ matt white	114421
910lm 3000K CRI>80	
■ matt aluminium	114426

Variant	Item no.
910lm 3000K CRI>80	
■ matt black	114430
910lm 3000K CRI>80	
□ matt white	114431
910lm 3000K CRI>80	
■ matt aluminium	114436

Variant	Item no.
400lm 3000K CRI>80	
■ black	1001015
400lm 3000K CRI>80	
□ white	1001016
400lm 4000K CRI>80	
■ black	1001017
400lm 4000K CRI>80	
□ white	1001018

INGROUND FITTINGS

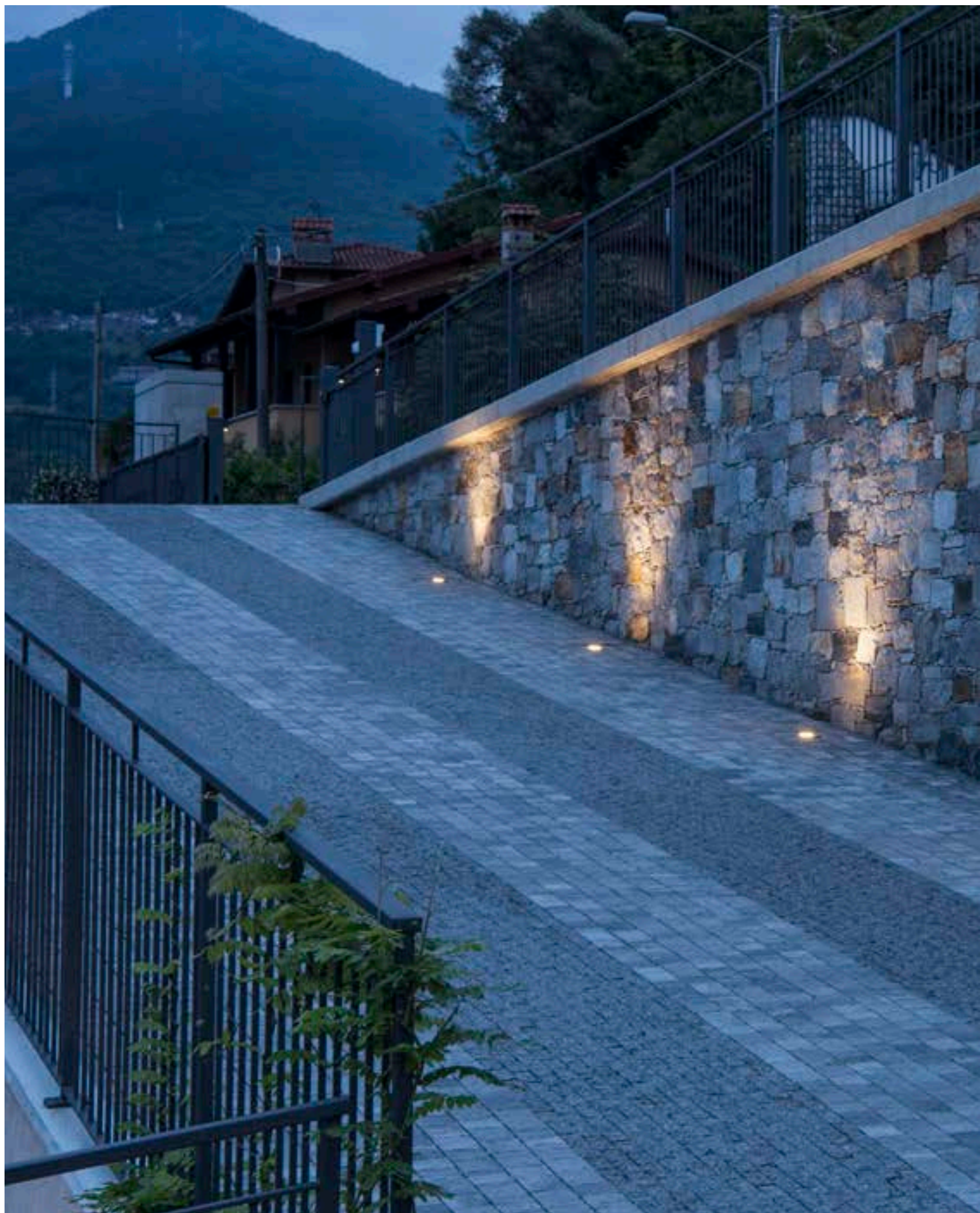

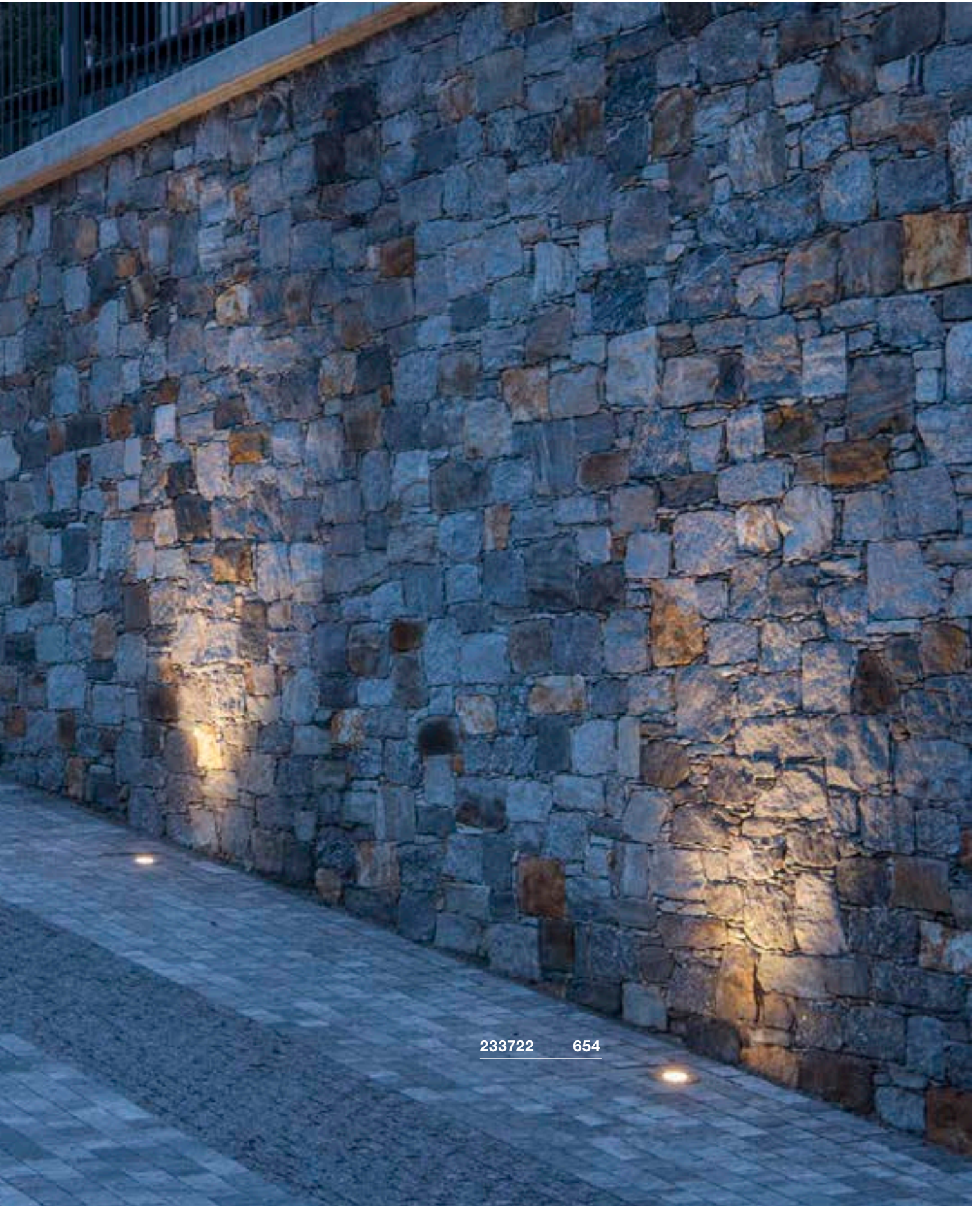

233722

654

BIG PLOT
Modules

A-A++ Range A++-E



- Stainless steel 316
- Extremely high IP protection class
- Different lighting effect can be achieved with the aid of suitable covers

Product details

220-240V ~50/60Hz 16mA
Total consumption: 5.5W
Material: Stainless steel 316L/PMMA



Dimensioned drawing

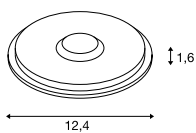

Note

Open cable end
Product is supplied without cover.
Suitable covers can be found on page 715.

Recommended accessories

■ IP68 connection box, 3-pole
Item no. 228730



Variant	Item no.
460lm 3000K CRI>80 ■ stainless steel	1001359

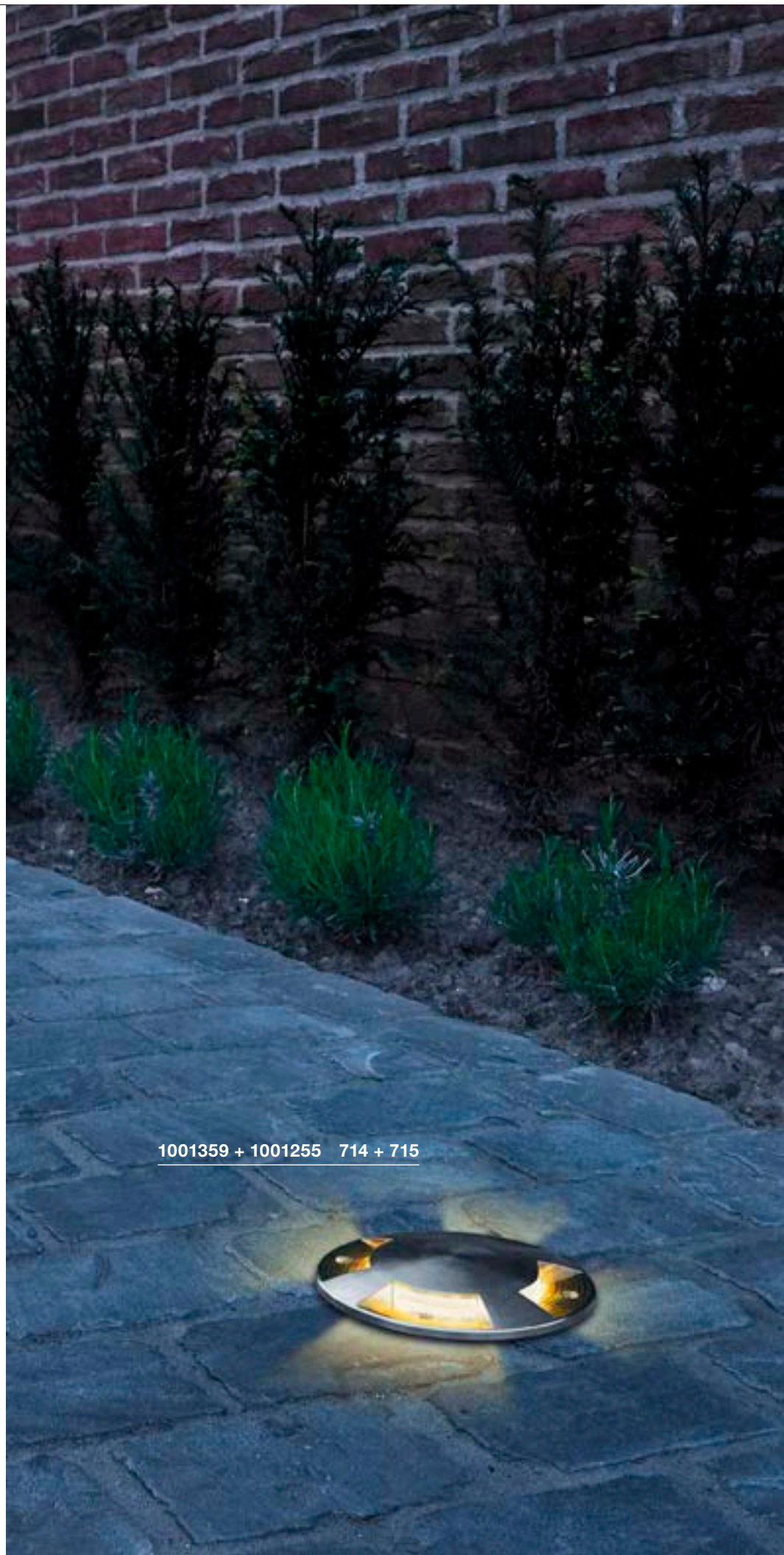

1001359 + 1001255 714 + 715

BIG PLOT
Modules

A-A++ Range A++-E



- Extremely high IP protection class
- Different lighting effect can be achieved with the aid of suitable covers

Product details

220-240V ~50/60Hz 16mA
Total consumption: 5.5W
Material: Aluminium/ PMMA



Dimensioned drawing

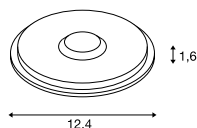

Note

Open cable end
Product is supplied without cover.
Suitable covers can be found on page 715.

Recommended accessories

■ IP68 connection box, 3-pole
Item no. 228730



Variant	Item no.
460lm 3000K CRI>80 ■ silver-grey	1001256

BIG PLOT
Cover, 2 slots

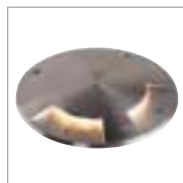

Product details

Material 1001254: Stainless steel 316
Material 1001252/1001262: Aluminium



Dimensioned drawing

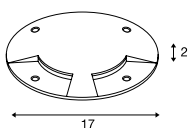

Variant	Item no.
0.91 kg 0.8 t ■ stainless steel	1001254
0.34 kg 0.5 t ■ silver-grey	1001252
0.34 kg 0.5 t ■ anthracite	1001262

BIG PLOT
Cover, 4 slots



Product details

Material 1001255: Stainless steel 316
Material 1001253/1001263: Aluminium



Dimensioned drawing

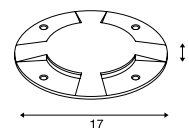

Variant	Item no.
0.85 kg 0.8 t ■ stainless steel	1001255
0.33 kg 0.5 t ■ silver-grey	1001253
0.33 kg 0.5 t ■ anthracite	1001263

TRAIL-LITE® 60
EL

A-A++ Range
A++-E



• Panel: Stainless steel 316

Product details

12V / 0.3W
Material: Stainless steel 316 / Glass



Dimensioned drawing

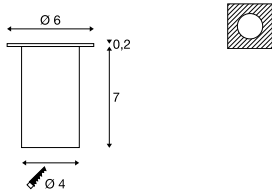

Note

Only operate with a conventional transformer.
Mounting pot included
The luminaire is suitable for installation in wood

Recommended accessories

■ Transformer 12V AC | 10VA IP44
Item no. 227140



Variant	Item no.
10lm 6500K CRI>80 brushed stainless steel	227461
10lm 3000K CRI>80 brushed stainless steel	227462

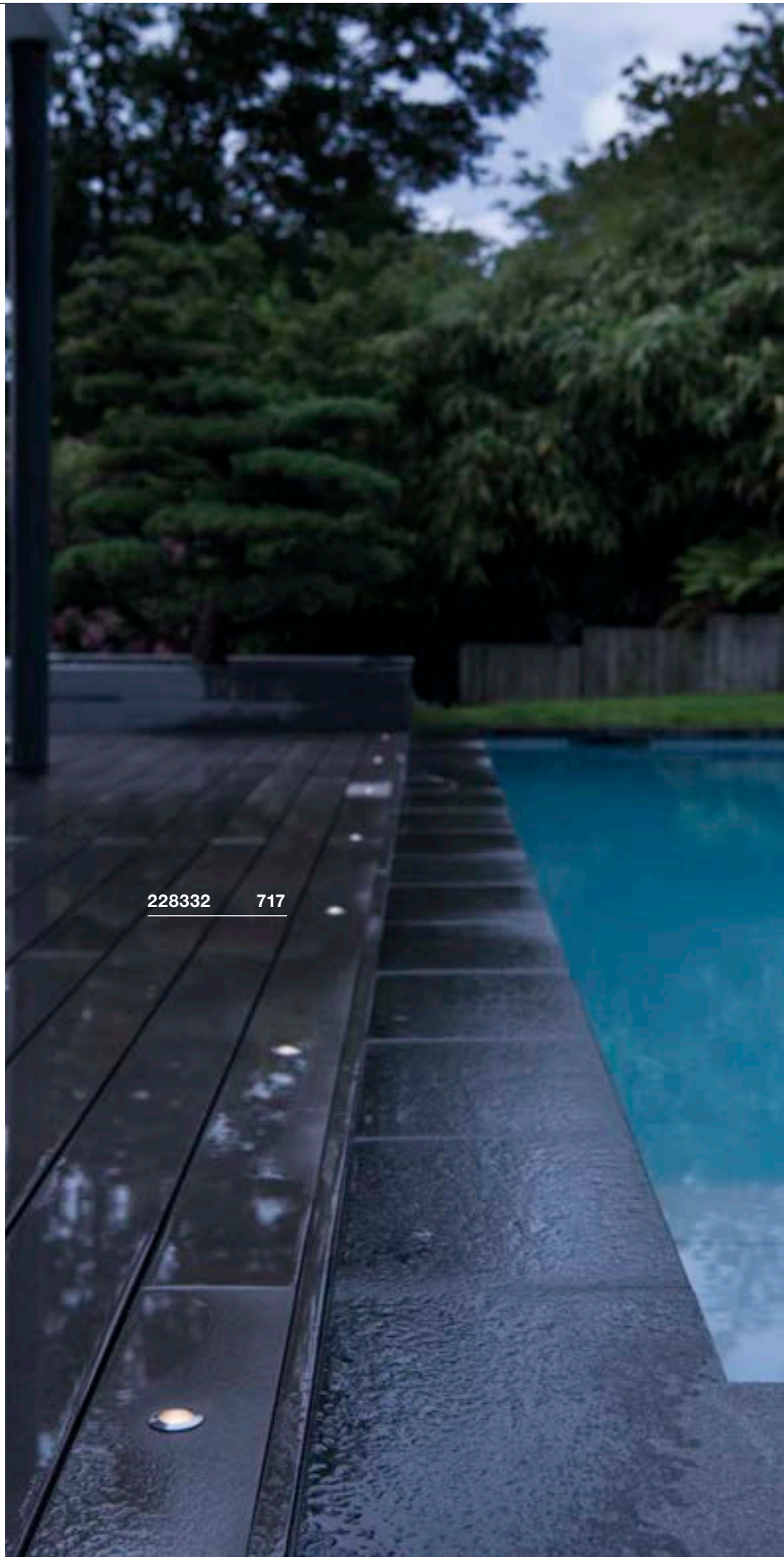

228332 717



227462 716



227461 716

POWER TRAIL-LITE®
EL, round

A-A++ Range A++-E



- Panel: Stainless steel 316
- Premium LED

Product details

350mA / 1.4W
Material: Stainless steel 316 / Glass

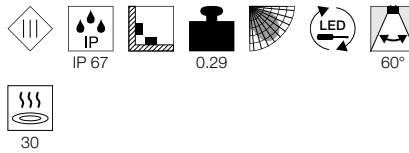

Dimensioned drawing

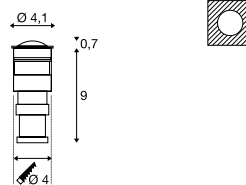

Note

Only operate with a 350mA driver. Only wire several PowerLEDs together in series!
Installation sleeve incl.
The luminaire is suitable for installation in wood.

Recommended accessories

LED driver 350mA | 3W incl. strain relief

Item no. 464108

LED driver 350mA | 9W

Item no. 464109



POWER TRAIL-LITE®
EL, square

A-A++ Range A++-E

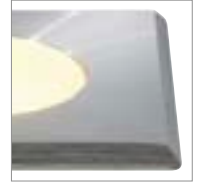

Product details

350mA / 1.4W
Material: Stainless steel 316 / Glass

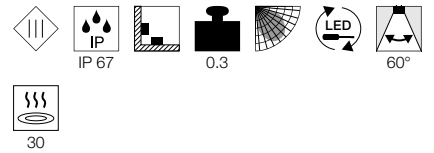

Dimensioned drawing

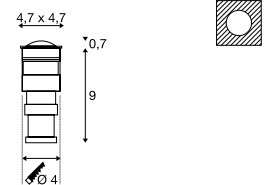

Note

Only operate with a 350mA driver. Only wire several PowerLEDs together in series!
Installation sleeve incl.
The luminaire is suitable for installation in wood.

Recommended accessories

LED driver 350mA | 3W incl. strain relief

Item no. 464108

Connection box

Item no. 229260



Variant	Item no.
45lm 3000K CRI>90	
■ stainless steel	228332
48lm 4000K CRI>90	
■ stainless steel	1002189

Variant	Item no.
45lm 3000K CRI>90	
■ stainless steel	228342

SOLASTO
EL, square/round

A-A++ Range A++-E



• Panel: Stainless steel 316

Product details

230V ~50Hz
Material: Plastic / Stainless steel 304 / Glass



Dimensioned drawing

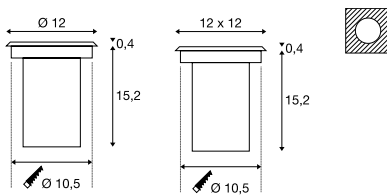

Note

Mounting pot incl.

Recommended lamp

LED GU10 5.5W 38°
2800K 500lm EEL=A+
6kWh/1000h
Item no. 1001217



LED GU10 5.5W 38°
2700K 400lm EEL=A+
6kWh/1000h | 3 Step-Dim
Item no. 1001030



Lamp details

6W max.

Variant	Item no.
GU10 LED GU10 51mm ○ ■ stainless steel	227680
GU10 LED GU10 51mm □ ■ stainless steel	227684



227684 718



227680 718

WETSY
EL, square/round

A-A++ Range A++-E

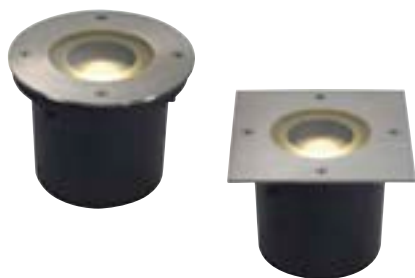

- Panel: Stainless steel 316

Product details

220-240V ~50/60Hz
Total consumption: 6.3W
Material: Stainless steel 316 / Aluminium / Glass

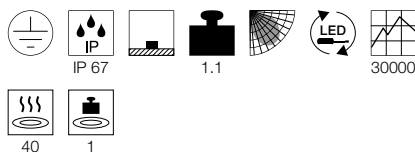

Dimensioned drawing

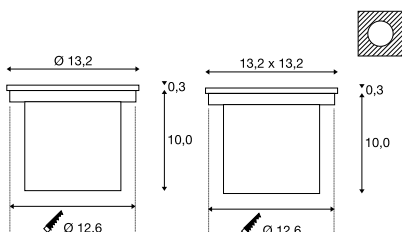

Note

Mounting pot incl.

ROCCI
EL, round

A-A++ Range A++-E



- Panel: Stainless steel 316
- Premium LED

Product details

200-240V ~50/60Hz 700mA
Total consumption: 9.8W
Material: Stainless steel 316 / Aluminium / Glass

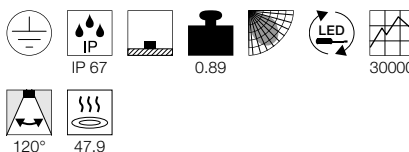

Dimensioned drawing

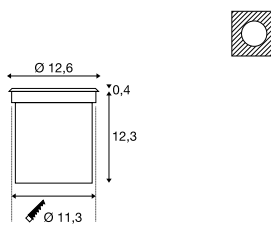

Note

Mounting pot incl.

ROCCI
EL, square

A-A++ Range A++-E



- Panel: Stainless steel 316
- Premium LED

Product details

200-240V ~50/60Hz 700mA
Total consumption: 9.8W
Material: Stainless steel 316 / Aluminium / Glass

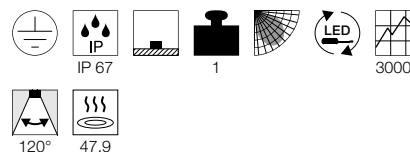

Dimensioned drawing

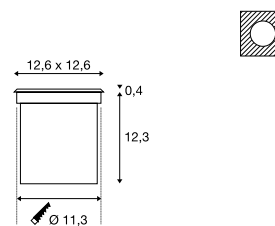

Note

Mounting pot incl.

Recommended accessories

■ IP68 connection box, 3-pole
Item no. 228730



Variant	Item no.
300lm 3000K CRI>80 ○ ■ stainless steel	230170
300lm 3000K CRI>80 □ ■ stainless steel	230174

Variant	Item no.
580lm 3000K CRI>80 ■ stainless steel	227600
630lm 4000K CRI>80 ■ stainless steel	1002185

Variant	Item no.
580lm 3000K CRI>80 ■ stainless steel	227604
630lm 4000K CRI>80 ■ stainless steel	1002186

GIMBLE OUT EL

A-A++ Range
A++-E

LED
INSIDE



- Housing and panel: Stainless steel 316L
- Premium LED

Product details

220-240V ~50/60Hz 600mA
Total consumption: 13W
Material: Stainless steel 316L / Glass

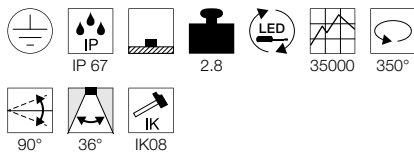

Dimensioned drawing

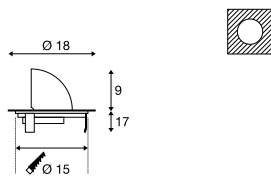

Note

Open cable end

Recommended accessories

■ Installation tube DN160

Item no. 233792

■ IP68 connection box, 3-pole

Item no. 228730

■ Inground pot

Item no. 1000655

■ DN160 Installation spring for wood installation

Item no. 233797

Variant	Item no.
1000lm 3000K CRI>80	
■ brushed stainless steel	1000384



1000834 720

ADJUST 135
EL, square/round, QPAR51

E-A++ Range A++-E



- Panel: Stainless steel 304

Product details

230V ~50Hz
Material: Plastic

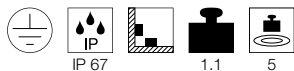

Dimensioned drawing

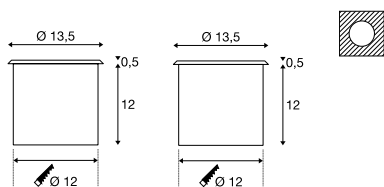

Note

Mounting pot incl.

Recommended lamp

LED GU10 7.2W 36°
4000K 590lm EEL=A+
8kWh/1000h
Item no. 1001565



LED GU10 7.2W 36°
2700K 470lm EEL=A+
8kWh/1000h
Item no. 1001560



Lamp details

35W max.
Ø: 5 cm max. L: 5.7 cm max.
optional: LED

Variant	Item no.
GU10 QPAR51	
○ ■ stainless steel	228210
GU10 QPAR51	
○ ■ stainless steel	228214

ADJUST 190
EL, square/round, QR111

D-A+ Range A++-E



- Panel: Stainless steel 304
- Tilttable

Product details

230V ~50Hz 12V AC
Material: Stainless steel 304 / Aluminium / Glass



Dimensioned drawing

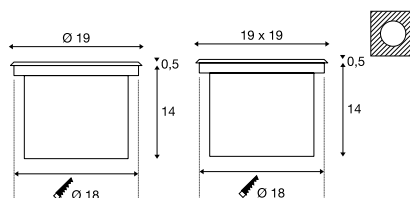

Note

Mounting pot incl.

Recommended lamp

LED G53 9W 13°
4000K 800lm EEL=A+
10kWh/1000h
Item no. 560624



LED G53 15W 24°
3000K 770lm EEL=A
17kWh/1000h
Item no. 560233



Lamp details

50W max.
optional: LED

Variant	Item no.
G53 QR111	
○ ■ stainless steel	227090
G53 QR111	
○ ■ stainless steel	227092

ADJUST 265
EL, round, HIT-CE

A-A+ Range A++-E



- Panel: Stainless steel 304

Product details

230V ~50Hz
Material: Stainless steel 304 / Aluminium / Glass



Dimensioned drawing

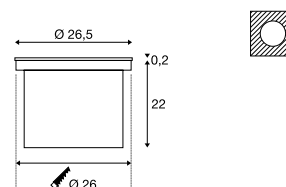

Note

Mounting pot incl.

Recommended lamp

70W

Lamp details

Variant	Item no.
G12 HIT-CE	
■ anthracite grey RAL7016	228240

DASAR® FLAT 80 EL

A-A++ Range
A++-E



- Panel: Stainless steel 304
- Extremely flat design

Product details

230V ~50/60Hz

Total consumption: 4.3W

Material: Stainless steel 304 / Aluminium / Glass

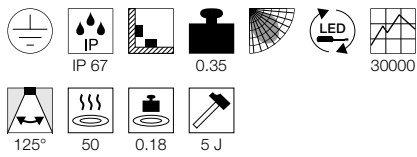

Dimensioned drawing

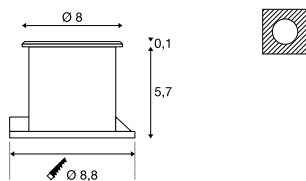

Note

Mounting pot incl.

Recommended accessories

■ IP68 connection box, 3-pole

Item no. 228730



Variant	Item no.
140lm 3000K CRI>80 ■ brushed stainless steel	228412
150lm 5000K CRI>80 ■ brushed stainless steel	228411
140lm 4000K CRI>80 ■ brushed stainless steel	1002188

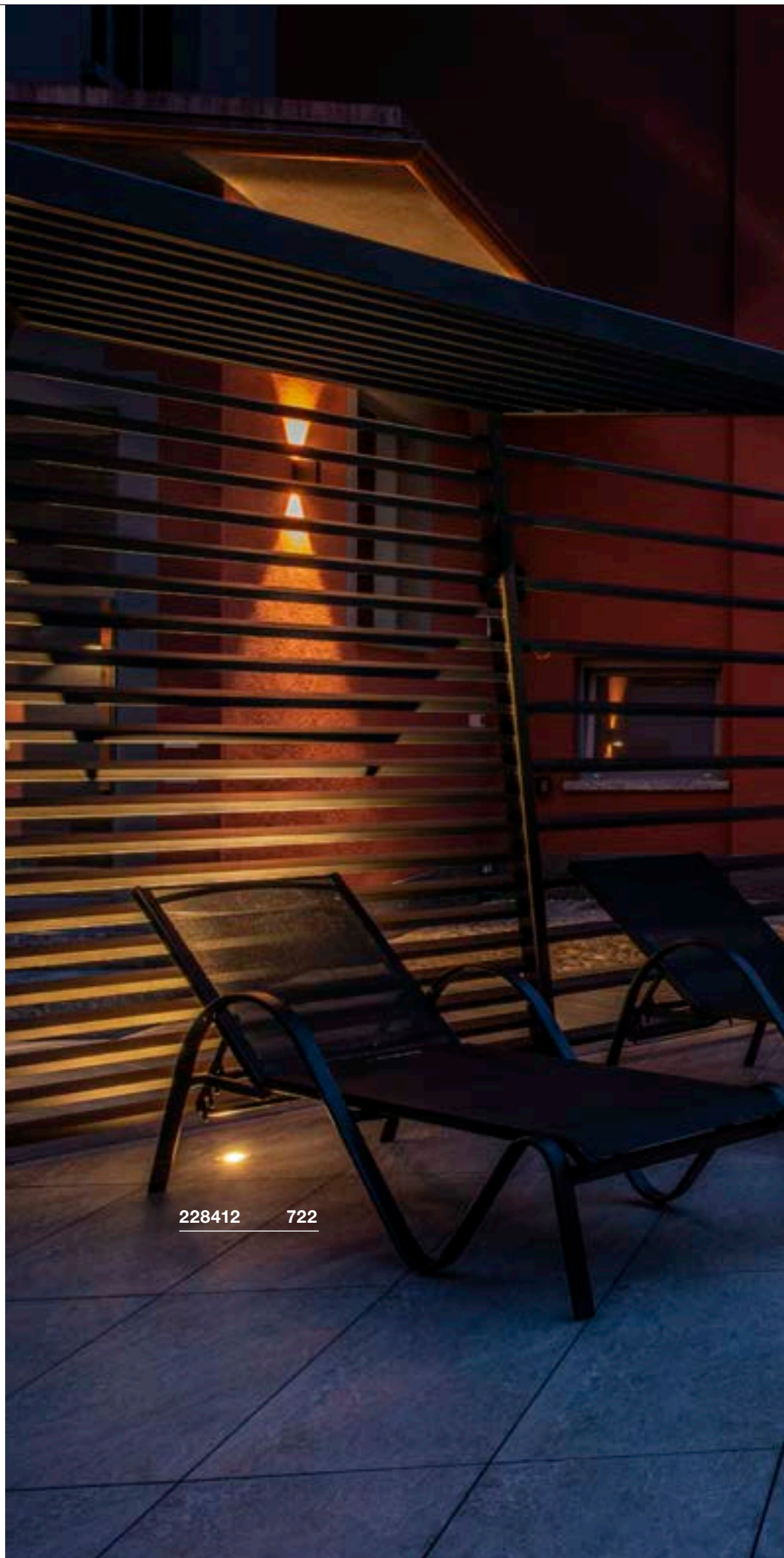

228412 722



233540 **723**

DASAR® 370
EL, square/round

A-A++ Range A++-E

LED
INSIDE

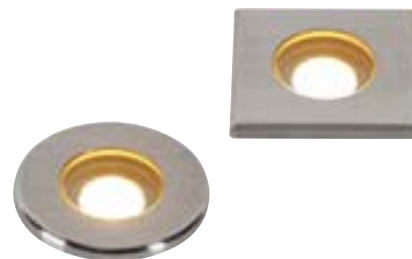

- Housing and panel: Stainless steel 316L
- Premium LED

Product details

12V/24V DC
Material: Stainless steel 316L / Glass

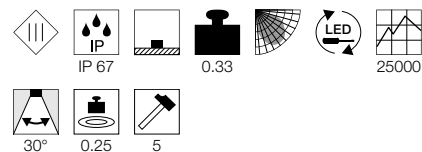

Dimensioned drawing

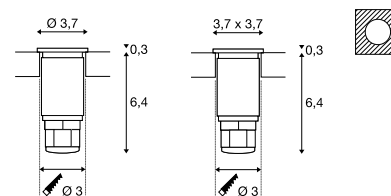

Note

Open cable end

Recommended accessories

- LED power supply 24V DC | 12W
Item no. 470502
- LED power supply, 12V DC | 12W
Item no. 470507

Variant	Item no.
120lm 3000K CRI>80	
○ ■ brushed stainless steel	233540
120lm 3000K CRI>80	
□ ■ brushed stainless steel	233550

DASAR® HIGHLIGHTS.

NO COMPROMISES – STAINLESS STEEL 316.

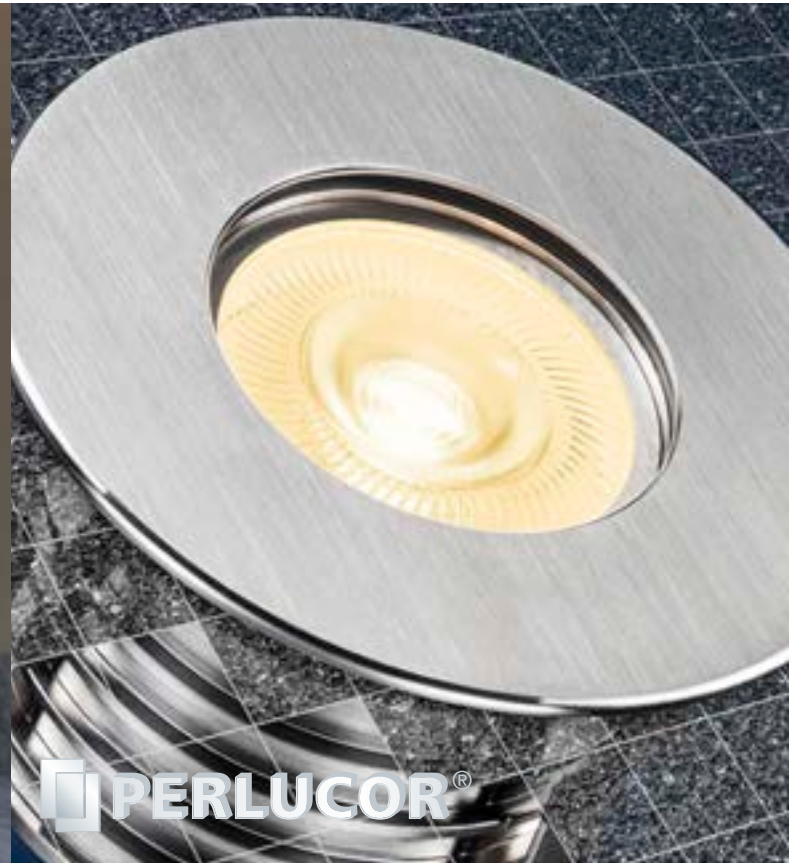

DASAR® 920 | 725

Variants:

- Panel stainless steel 316
- Housing and panel stainless steel 316



DASAR® 100 PREMIUM | 726-727

- Round and square
- Cover stainless steel 316L
- **PERLUCOR®** Glass:
5x harder and 100x more scratch resistant than conventional glass



DASAR® 150 PREMIUM | 727

- Round and square
- Cover stainless steel 316L
- **PERLUCOR®** Glass:
5x harder and 100x more scratch resistant than conventional glass

DASAR® 920 EL

A-A++ Range A++-E



- Panel: Stainless steel 316
- Premium LED

Product details

12V DC / 24V DC / 7W
Material: Stainless steel 316 / Aluminium / Glass

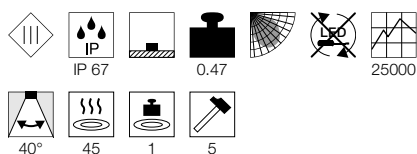

Dimensioned drawing

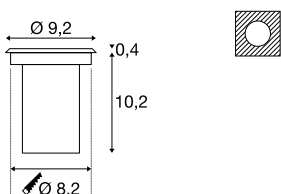

Note

Mounting pot incl.
Open cable end

Recommended accessories

LED power supply 24V DC | 12W
Item no. 470502

LED power supply 12V DC | 12W
Item no. 470507

Variant	Item no.
360lm 3000K CRI>80 ■ brushed stainless steel	233500

DASAR® 920 EL

A-A++ Range A++-E



- Panel: Stainless steel 316
- Premium LED

Product details

220-240V ~50/60Hz 400mA
Total consumption: 5.5W
Material: Stainless steel 316 / Aluminium / Glass

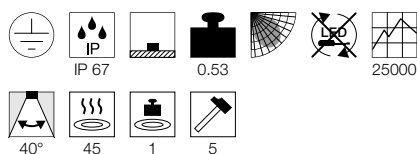

Dimensioned drawing

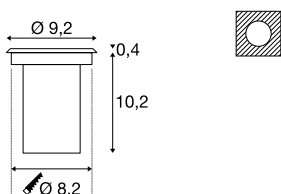

Note

Mounting pot incl.
Open cable end

Variant	Item no.
300lm 3000K CRI>80 ■ brushed stainless steel	233520

DASAR® 920 EL

A-A++ Range A++-E



- Housing and panel: Stainless steel 316
- Premium LED

Product details

220-240V ~50/60Hz 400mA
Total consumption: 5.5W
Material: Stainless steel 316 / Glass

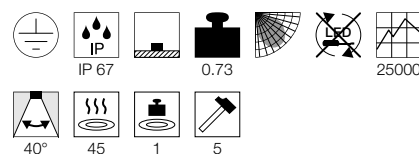

Dimensioned drawing

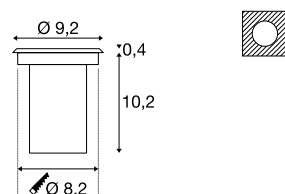

Note

Mounting pot incl.
Open cable end

Variant	Item no.
300lm 3000K CRI>80 ■ brushed stainless steel	233530
360lm 4000K CRI>80 ■ brushed stainless steel	1002187



1002187 727



233712 727

DASAR® 100 PREMIUM
EL, square

A-A++ Range A++-E

LED INSIDE PERLUCOR®



- 5x harder and 100x more scratch resistant than conventional glass
- Panel: Stainless steel 316L
- The glass is thermally, chemically, mechanically and optically resistant. Can be walked on and is scratch resistant. A surface which is almost self-cleaning. Can withstand extreme loads

Product details

220-240V ~50/60Hz 400mA
Total consumption: 5.5W
Material: Aluminium / Stainless steel 316L / Glass

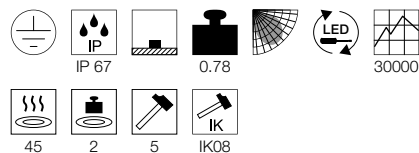

Dimensioned drawing

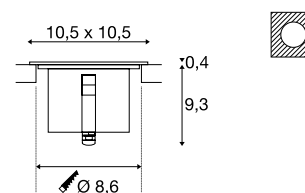

Note

Excludes inground tube or pot.
With installation tube (233790), can withstand load of 2t, With inground tube (1000653), can withstand load of 0.5t. Suitable for installation tubes, Open cable end, Mounting clips incl.

Recommended accessories

- T-connector box
Item no. 228726
- Installation tube DN90
Item no. 233790
- DN90 installation spring for wood installation
Item no. 233795
- Inground pot
Item no. 1000653

Variant	Item no.
300lm 3000K CRI>80 24°	
■ stainless steel	233692
300lm 3000K CRI>80 60°	
■ stainless steel	233696

DASAR® 100 PREMIUM
EL, round



- 5x harder and 100x more scratch resistant than conventional glass
- Panel: Stainless steel 316L
- The glass is thermally, chemically, mechanically and optically resistant. Can be walked on and is scratch resistant. A surface which is almost self-cleaning. Can withstand extreme loads

Product details

220-240V ~50/60Hz 400mA
Total consumption: 5.5W
Material: Aluminium / Stainless steel 316L / Glass

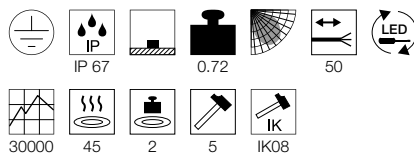

Dimensioned drawing

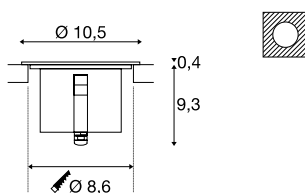

Note

Excludes in-ground tube or pot.
With installation tube (233790), can withstand load of 2t. With in-ground pot (1000653), can withstand load of 0.5t. Suitable for in-ground tubes, Open cable end, Mounting clips incl.

Recommended accessories

- T-connector box
Item no. 228726
- Installation tube DN90
Item no. 233790
- DN90 installation spring for wood installation
Item no. 233795
- In-ground pot
Item no. 1000653

Variant	Item no.
300lm 3000K CRI>80 24° ■ stainless steel	233672
300lm 3000K CRI>80 60° ■ stainless steel	233676

DASAR® 150 PREMIUM
EL, round



- 5x harder and 100x more scratch resistant than conventional glass
- Panel: Stainless steel 316L
- The glass is thermally, chemically, mechanically and optically resistant. Can be walked on and is scratch resistant. A surface which is almost self-cleaning. Can withstand extreme loads

Product details

220-240V ~50/60Hz 620mA
Total consumption: 17W
Material: Aluminium / Stainless steel 316L / Glass

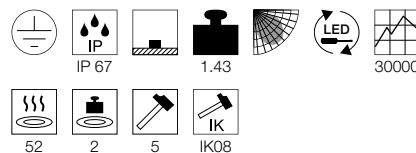

Dimensioned drawing

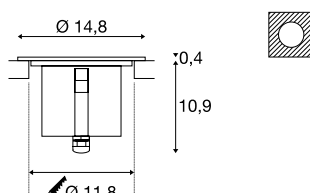

Note

Excludes in-ground tube or pot.
With installation tube (233791), can withstand load of 2t. With in-ground tube (1000654), can withstand load of 0.5t. Suitable for installation tubes, Open cable end, Mounting clips incl.

Recommended accessories

- T-connector box
Item no. 228726
- Installation tube DN125
Item no. 233791
- DN125 installation spring for wood installation
Item no. 233796
- In-ground pot
Item no. 1000654

Variant	Item no.
1200lm 3000K CRI>80 30° ■ stainless steel	233712
1200lm 3000K CRI>80 60° ■ stainless steel	233716

DASAR® 150 PREMIUM
EL, square



- 5x harder and 100x more scratch resistant than conventional glass
- Panel: Stainless steel 316L
- The glass is thermally, chemically, mechanically and optically resistant. Can be walked on and is scratch resistant. A surface which is almost self-cleaning. Can withstand extreme loads

Product details

220-240V ~50/60Hz 620mA
Total consumption: 17W
Material: Aluminium / Stainless steel 316L / Glass

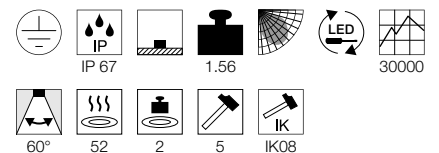

Dimensioned drawing

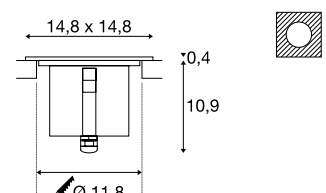

Note

Excludes in-ground tube or pot.
With installation tube (233791), can withstand load of 2t. With in-ground tube (1000654), can withstand load of 0.5t. Suitable for installation tubes, Open cable end, Mounting clips incl.

Recommended accessories

- T-connector box
Item no. 228726
- Installation tube DN125
Item no. 233791
- DN125 installation spring for wood installation
Item no. 233796
- In-ground pot
Item no. 1000654

Variant	Item no.
1200lm 3000K CRI>80 30° ■ stainless steel	233732
1200lm 3000K CRI>80 60° ■ stainless steel	233736



229320 729



229374 729



229324 728

DASAR® 80
EL, square/round, QPAR51



- Panel: Stainless steel 316

Product details

230V ~50Hz
Material: Stainless steel 316 / Aluminium / Glass



Dimensioned drawing

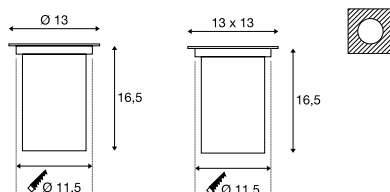

Note

Mounting pot incl.

Recommended lamp

LED GU10 5.5W 38°
3000K 440lm EEL=A+
6kWh/1000h | **3 Step-Dim**
Item no. 551902



LED GU10 7.2W 36°
3000K 470lm EEL=A+
8kWh/1000h



Item no. 1001562

Lamp details

35W max.
Ø: 5 cm max. L: 6 cm max.
optional: LED

Variant	Item no.
GU10 QPAR51	
○ ■ stainless steel	229320
GU10 QPAR51	
□ ■ stainless steel	229324

DASAR® 70
EL, square, QPAR51



- Panel: Stainless steel 304

Product details

230V ~50Hz
Material: Stainless steel 304 / Aluminium / Glass

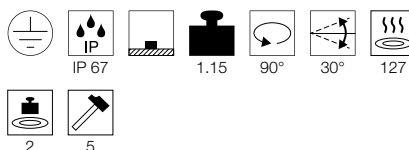

Dimensioned drawing

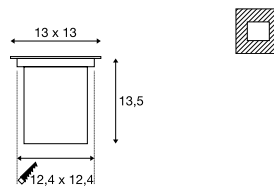

Note

Mounting pot incl.

Recommended lamp

LED GU10 5.5W 36°
2800K 500lm EEL=A+
6kWh/1000h
Item no. 1001217



LED GU10 5.5W 38°
2700K 400lm EEL=A+
6kWh/1000h | **3 Step-Dim**



Item no. 1001030

Lamp details

35W max.
Ø: 5 cm max. L: 6 cm max.
optional: LED

Variant	Item no.
GU10 QPAR51	
■ stainless steel	229374

DASAR® EXACT 116
EL, square/round, QPAR51



- Panel: Stainless steel 316
- For inground installation

Product details

230V ~50Hz
Material: Stainless steel 316 / Aluminium / Glass

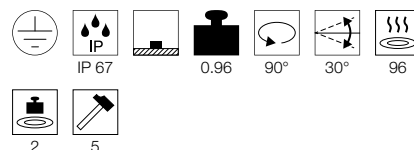

Dimensioned drawing

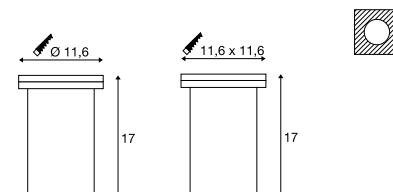

Note

Mounting pot incl.

Recommended lamp

LED GU10 5.5W 38°
3000K 440lm EEL=A+
6kWh/1000h | **3 Step-Dim**
Item no. 551902



LED GU10 7.2W 36°
3000K 470lm EEL=A+
8kWh/1000h



Item no. 1001562

Lamp details

35W max.
Ø: 5 cm max. L: 6 cm max.
optional: LED

Variant	Item no.
GU10 QPAR51	
○ ■ brushed stainless steel	228430
GU10 QPAR51	
□ ■ brushed stainless steel	228434

DASAR® 215
EL, square/round, QPAR111

E-A++ Range A++-E





- Panel: Stainless steel 316
- Straight, sophisticated design for maximum adaptability

Product details

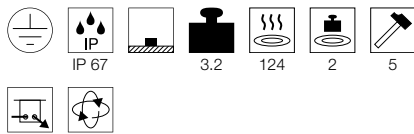
230V ~50Hz
Material: Stainless steel 316 / Aluminium / Glass

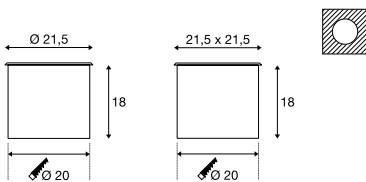

Dimensioned drawing



Note
Mounting pot incl.

Recommended lamp

- LED GU10 5.5W 36°
2800K 500lm EEL=A+
6kWh/1000h
Item no. 1001217
- LED GU10 5.5W 38°
2700K 400lm EEL=A+
6kWh/1000h | **3 Step-Dim**
Item no. 1001030

Lamp details

75W max.
optional: LED

Variant	Item no.
GU10 QPAR111	
○ stainless steel	229230
■ stainless steel	229234

DASAR® 218
EL, QR111

D-A+ Range A++-E



- Panel: Stainless steel 316
- Bigger swivelling range than conventional in-ground fitting

Product details

230V ~50Hz 12V AC
Material: Stainless steel 316 / Aluminium / Glass

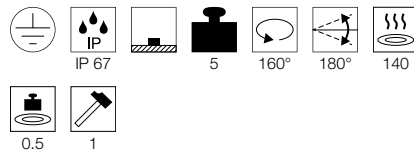

Dimensioned drawing

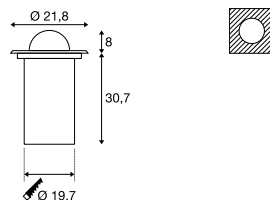

Note
Mounting pot incl.

Recommended lamp

- LED G53 9W 13°
4000K 800lm EEL=A+
10kWh/1000h
Item no. 560624
- LED G53 15W 24°
3000K 770lm EEL=A
17kWh/1000h
Item no. 560233

Lamp details

50W max.
optional: LED

Variant	Item no.
G53 QR111	
○ stainless steel	228370

DASAR® 215
EL, round, E27

A-A++ Range A++-E





- Panel: Stainless steel 316
- Straight, sophisticated design for maximum adaptability

Product details

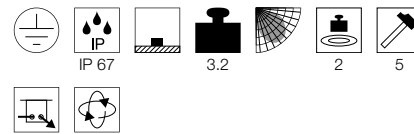
230V ~50Hz
Material: Stainless steel 316 / Aluminium / Glass

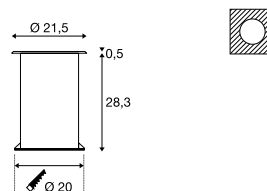

Dimensioned drawing



Note
Surface temperature:
Energy saver = 48°C/ PAR 30 = 119°C/
PAR 38 = 108°C
Mounting pot incl.

Recommended lamp

- LED E27 9W 240°
3000K 810lm EEL=A+
10kWh/1000h
Item no. 1001031

Lamp details

11W max.
Ø: 4.5 cm max. L: 13.4 cm max.
optional: LED PAR30 PAR38

Variant	Item no.
E27 TC(...)SE	
○ stainless steel	229200

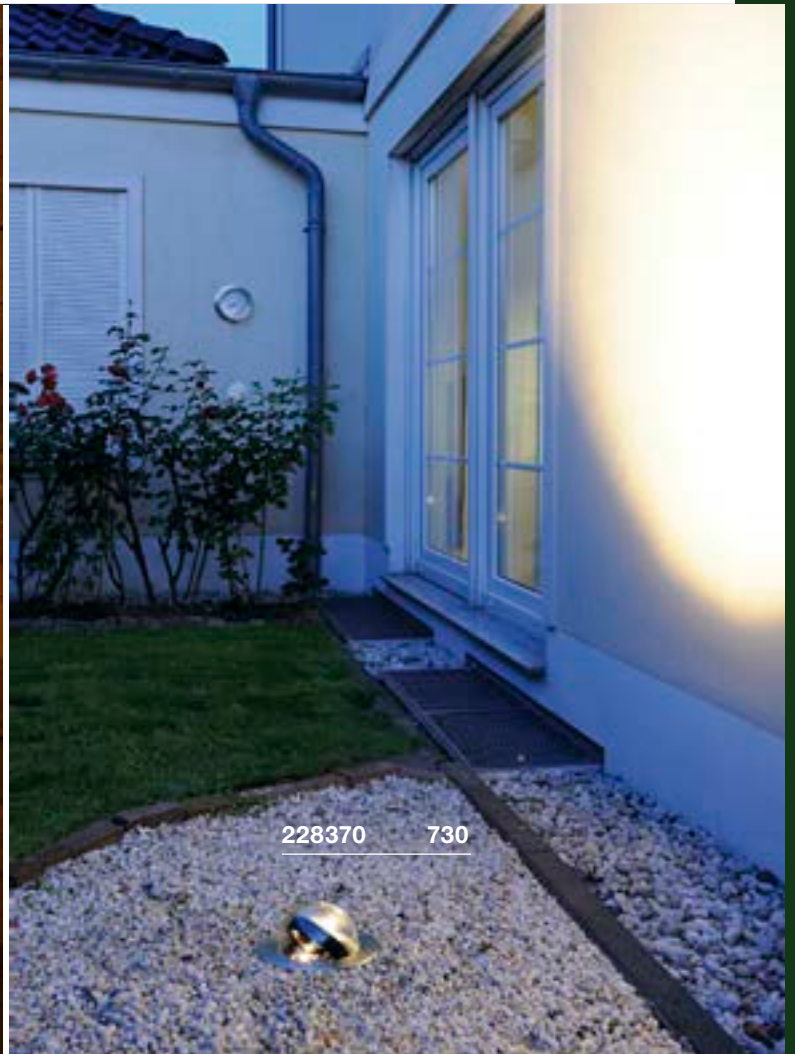



1002893 733

DASAR® 255
EL

A-A++ Range A++-E

LED INSIDE



- Panel: Stainless steel 316
- Asymmetrical reflector

Product details

220-240V ~50/60Hz 750mA
Total consumption: 34W
Material: Stainless steel 316 / Aluminium / Glass

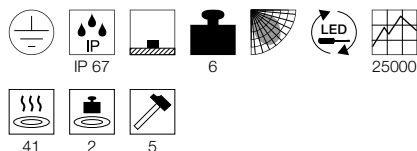

Dimensioned drawing

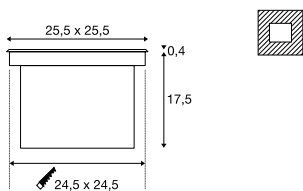

Note

Mounting pot incl.

Variant	Item no.
1620lm 4000K CRI>80 ■ stainless steel	229381
1620lm 3000K CRI>80 ■ stainless steel	229383

DASAR® 270
EL, asymmetrical

A-A++ Range A++-E

LED INSIDE

NEW



- Asymmetric light distribution

Product details

220-240V ~50/60Hz | 700mA
Total consumption: 30W
Material: Aluminium / Stainless Steel 316
Product dimensions: Ø: 27 cm H: 20.3 cm
Installation dimensions: Installation Ø: 25 cm D: 19.9 cm

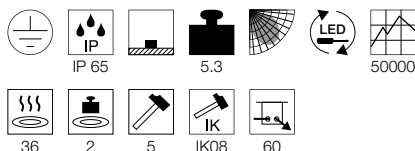

Note

Mounting pot incl.

Variant	Item no.
2000lm 3000K CRI>80 ■ matt black / brushed stainless steel	1002893
2100lm 4000K CRI>80 ■ matt black / brushed stainless steel	1002895

DASAR® 270
EL, symmetrical

A-A++ Range A++-E

LED INSIDE

NEW



- Symmetric light distribution
- Tilting lamp head

Product details

220-240V ~50/60Hz | 700mA
Total consumption: 30W
Material: Aluminium / Stainless Steel 316
Product dimensions: Ø: 27 cm H: 20.3 cm
Installation dimensions: Installation Ø: 25 cm D: 19.9 cm

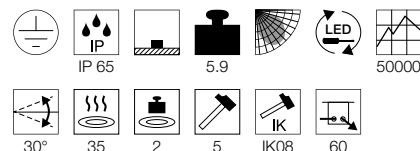

Note

Mounting pot incl.

Recommended accessories

- Honeycomb cover
Item no. 1002899

Variant	Item no.
2500lm 3000K CRI>80 ■ matt black / brushed stainless steel	1002897
2600lm 4000K CRI>80 ■ matt black / brushed stainless steel	1002898

DASAR®
EL, T16

A-A+ Range
A+-E

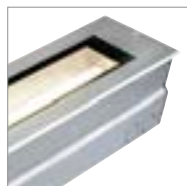

• Panel: Stainless steel 316

Product details

230V ~50Hz
Total consumption: 13.6W
Material: Stainless steel 316 / Aluminium / Glass

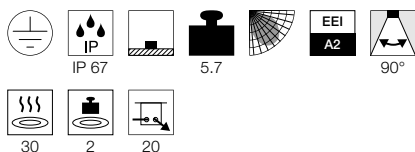

Dimensioned drawing

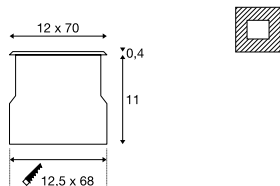

Note

Mounting pot incl.

Recommended lamp

G5 14W
3000K 1200lm EEL=A+
6kWh/1000h
Item no. 548014

Lamp details

14W

Variant	Item no.
G5 T16	
■ stainless steel	230100

DASAR®
EL, T16

A-A+ Range
A+-E

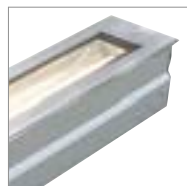

• Panel: Stainless steel 316

Product details

230V ~50Hz
Total consumption: 23.3W
Material: Stainless steel 316 / Aluminium / Glass

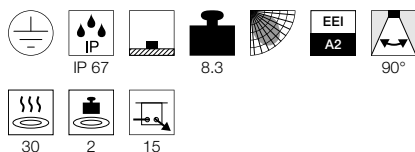

Dimensioned drawing

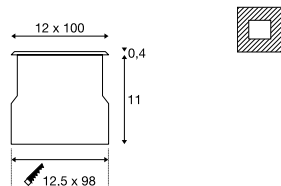

Note

Mounting pot incl.

Recommended lamp

G5 21W
3000K 1900lm EEL=A+
23kWh/1000h
Item no. 548021

Lamp details

21W

Variant	Item no.
G5 T16	
■ stainless steel	230110



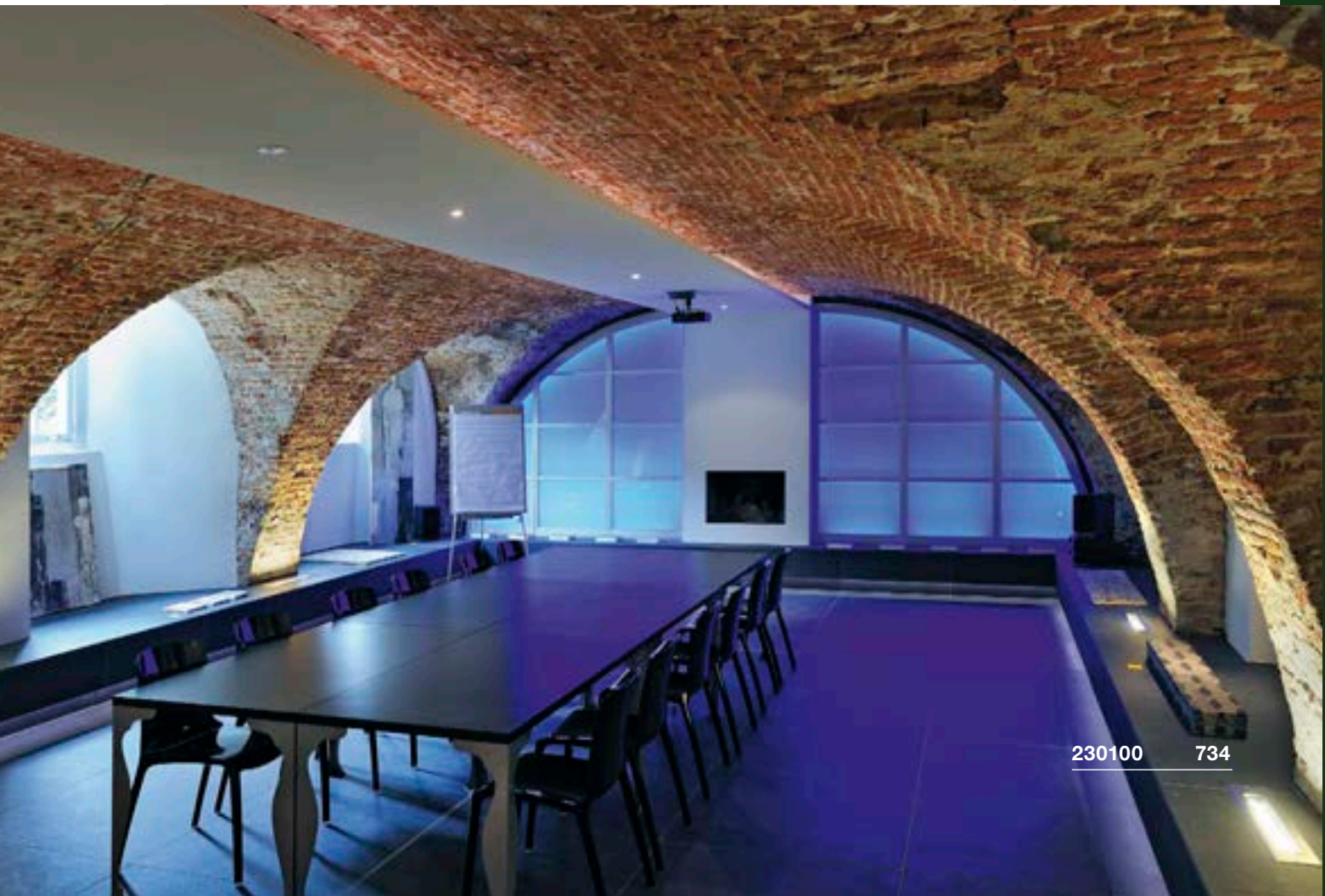

230100 734

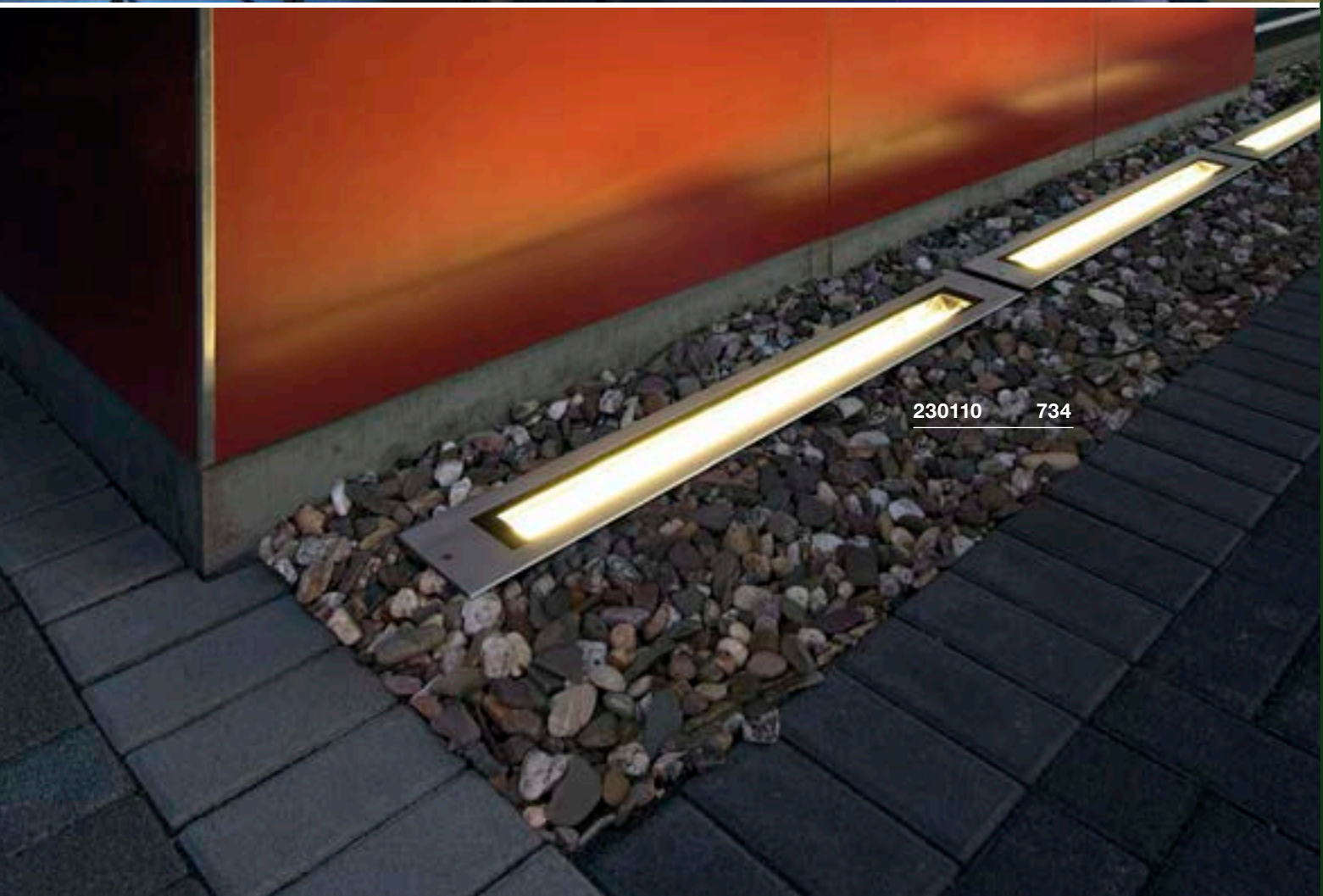

230110 734



IN CASE OF EMERGENCY.

Feel safe: With our fireproof solutions for standard-compliant increased fire protection in F90 ceilings. You are well prepared for emergencies with the SLV recessed and surface mounted luminaires for escape routes.

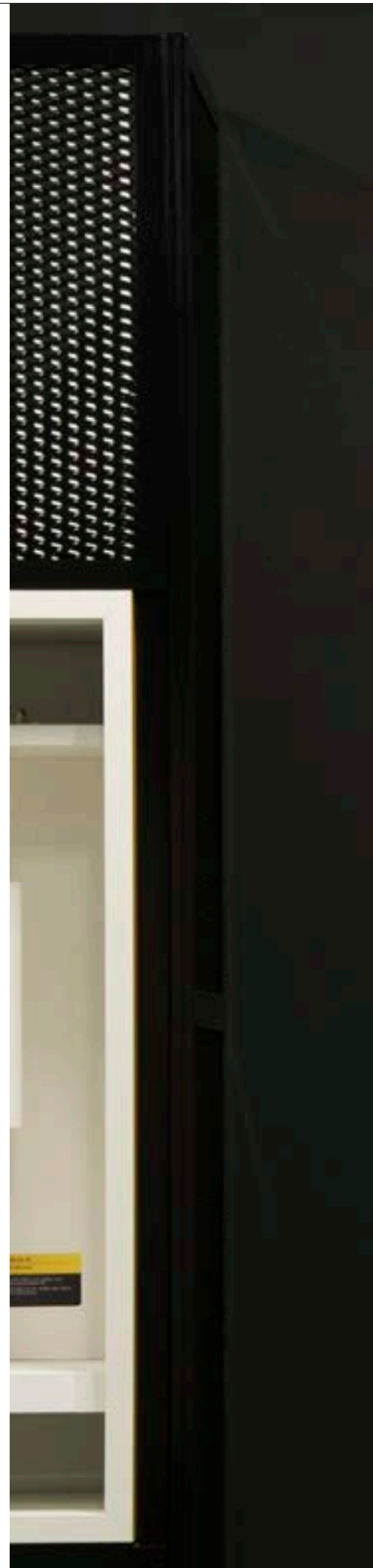



240000 740

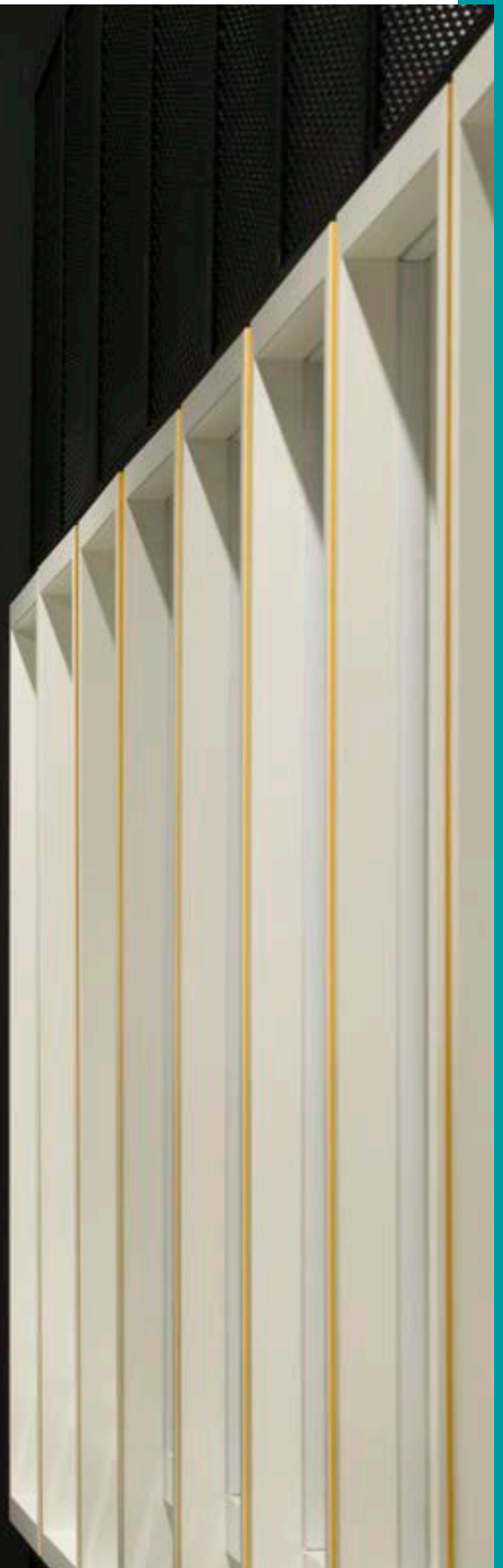

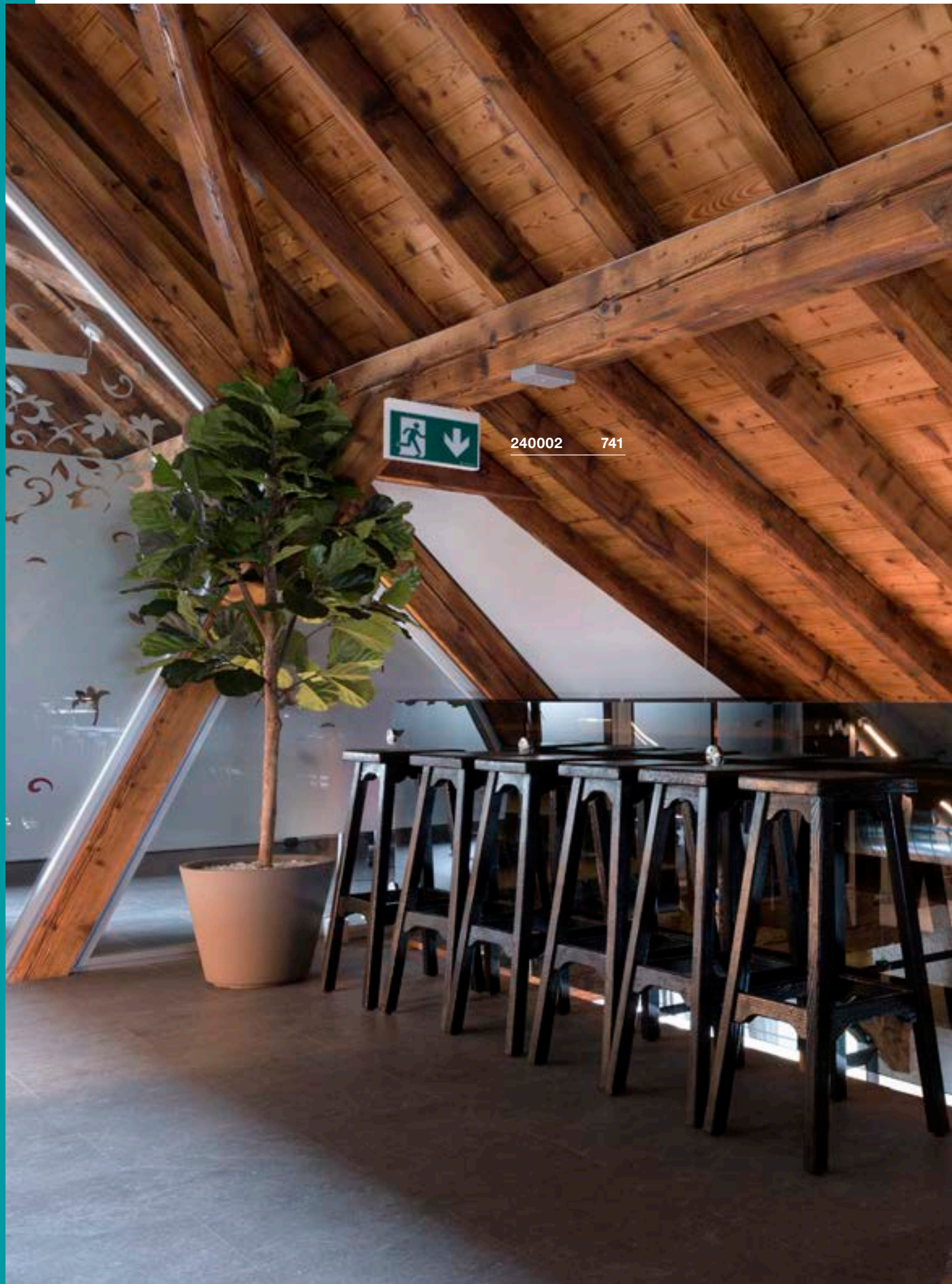

240002 741



240000 740



SAFETY SOLUTIONS



Other luminaires and variants can be found online at www.slv.com



P-LIGHT CW



A-A++ Range A++-E



- Detection range 24 m
- Easy to install
- Flexibly deployable as surface-mounted variant on ceiling or wall
- Flat emergency lighting with efficient LED technology
- Set of 4 pictograms for inserting enclosed

Product details

220-240V ~50Hz
 Total consumption: 3.5W
 Material: ABS / Polycarbonate (PC)

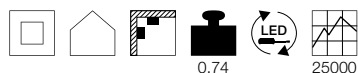

Dimensioned drawing

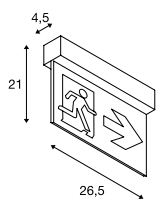

Note

Detection range 24 m, 3 rescue route symbols (right / left / down) and 1 white transparency enclosed. Emergency lighting with in-built Ni-Mh battery, with automatic self-test. Emergency operating time 3 hrs. luminance > 15cd/m². Operating mode: Continuously on / standby

Recommended accessories

Rechg. battery 3.6V | 900mA
 Item no. 240020

Set of pictogram transparencies
 Item no. 240007

Pictogram transparencies

Polypropylene (PP)
 W: 24 cm H: 13.1 cm



Set of 5 pictograms for inserting (left diagonally upwards / left diagonally downwards / right diagonally upwards / right diagonally downwards / upwards). 1 piece

Variant	Item no.
green	240007

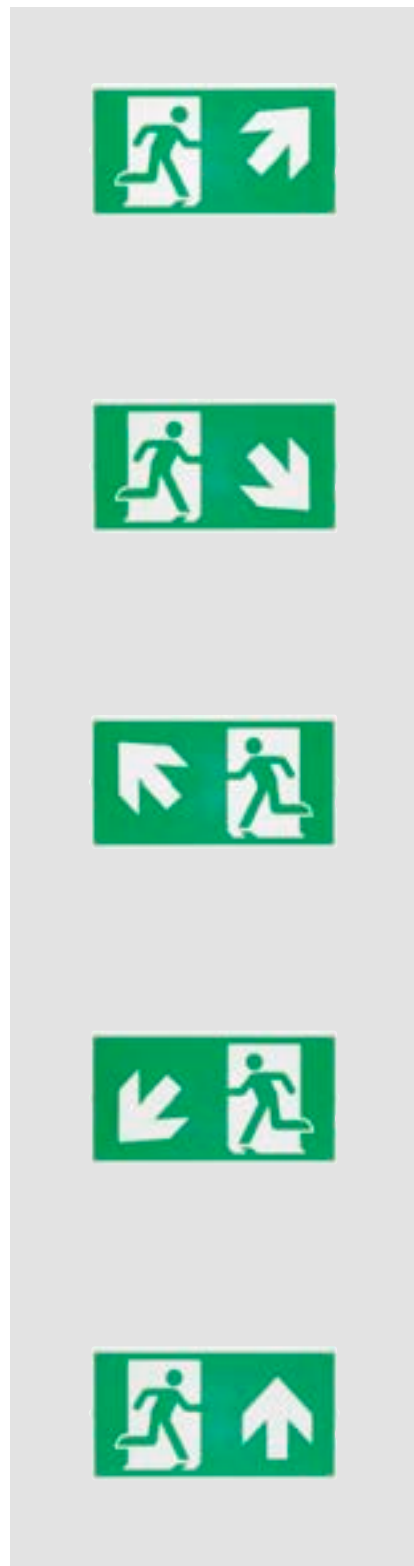

Variant	Item no.
32lm 6000K CRI>70	
white	240000



240002 741



240002 741

Pictogram transparencies

Polypropylene (PP)
W: 30 cm H: 16.1 cm



Set of 5 pictograms for inserting
(left diagonally upwards / left diagonally downwards / right diagonally upwards / right diagonally downwards / upwards).
1 piece

Variant **Item no.**

■ green 240008

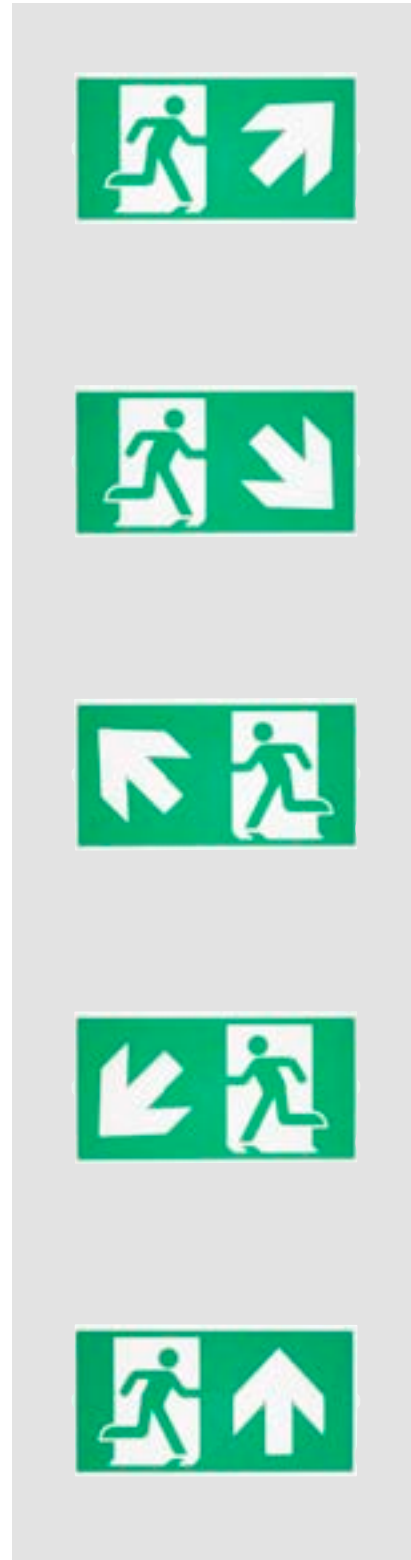

P-LIGHT CW

894

A-A++ Range A++-E

LED INSIDE



- Detection range 30 m
- Tested in accordance with DIN EN 60598-2-22
- Flexibly deployable as surface-mounted variant on ceiling or wall
- Extremely low maintenance costs due to efficient LED technology
- Set of 4 pictograms for inserting enclosed
- Easy to install

Product details

220-240V ~50/60Hz
Total consumption: 4W
Material: ABS / Polycarbonate (PC)

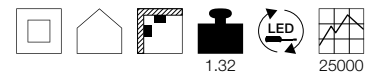

Dimensioned drawing

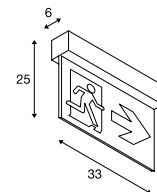

Note

Detection range 30 m, 3 rescue route symbols (right / left / down) and 1 white transparency enclosed. Emergency lighting with in-built Ni-Mh battery, with automatic self-test. Emergency operating time 3 hrs. luminance>15cd/m². Operating mode: Continuously on / standby

Recommended accessories

Rechg. battery 3.6V | 1000mA

Item no. 240021

Set of pictogram transparencies

Item no. 240008

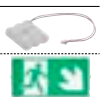

Variant **Item no.**

32lm | 6000K | CRI>70

white

240002

P-LIGHT
CL

894

A-A++ Range
A++-E

- Tested in accordance with DIN EN 60598-2-22
- Recessed ceiling light with efficient LED technology

Product details

220-240V ~50Hz

Total consumption: 5W

Material: ABS / Polycarbonate (PC)



Dimensioned drawing

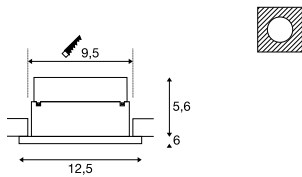

Note

Can be used as emergency lighting. Auto test function, Ni-Mh battery 2x 3.6V 1.5Ah included. Emergency battery operation 3 hrs. half beam angle 90° material thickness of installation surface: 25 mm max.

Recommended accessories

 Rechg. battery 7.2V | 1000mA

Item no. 240024



Variant	Item no.
120lm 6000K CRI>70	
<input type="checkbox"/> white	240006

240006 702

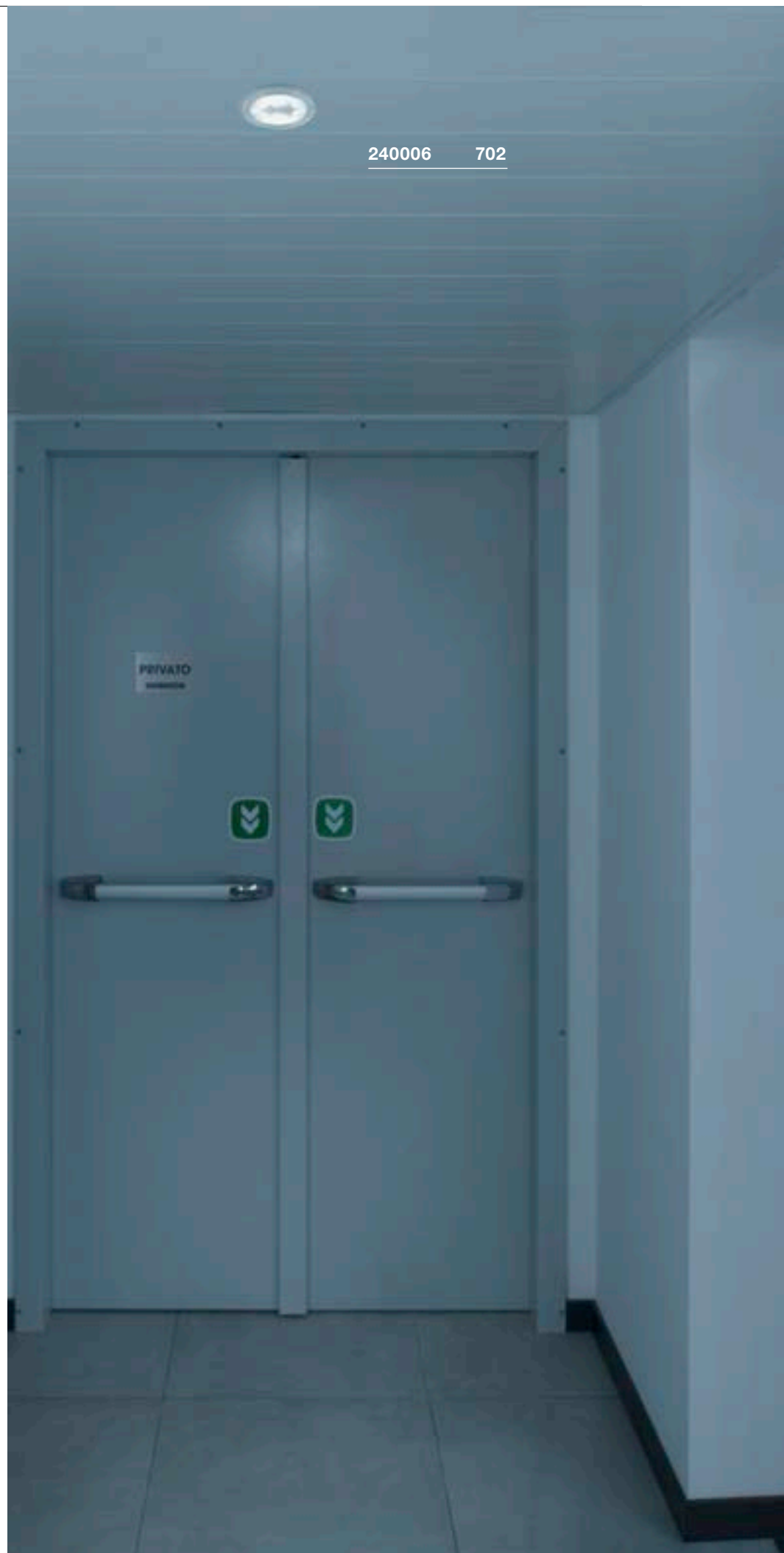

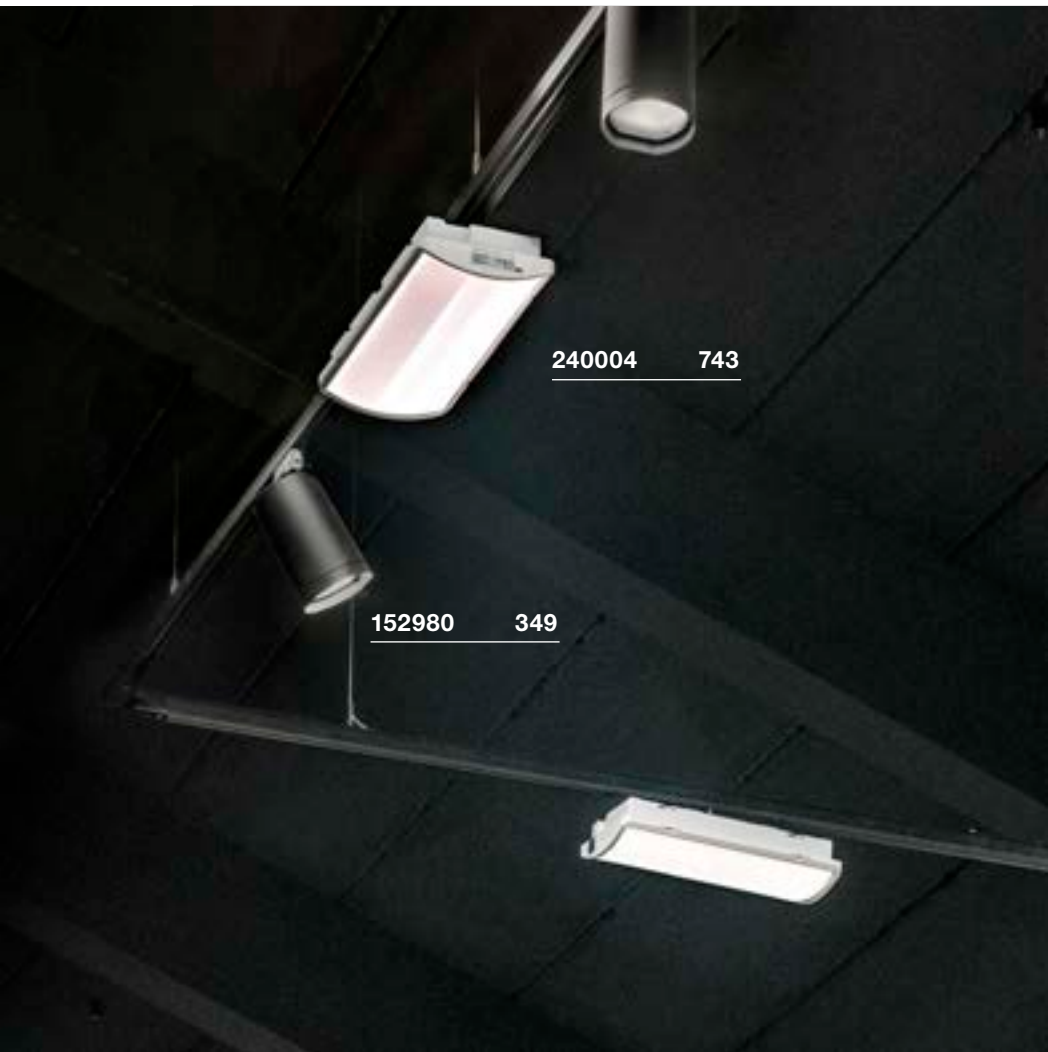

P-LIGHT CW



A-A++ Range A++-E

LED INSIDE



- Detection range 30 m
- IP 65 luminaire with efficient LED technology
- Tested in accordance with DIN EN 60598-2-22
- Flexibly deployable as surface-mounted variant on ceiling or wall
- Easy to install

Product details

220-240V ~50Hz
 Total consumption: 6.5W
 Material: Polycarbonate (PC)

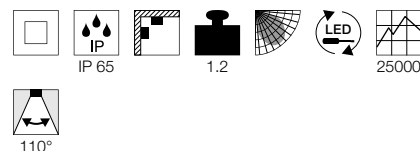

Dimensioned drawing

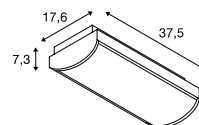

Note

Detection distance 30 m. Use as emergency lighting. Auto test function. Ni-Mh battery 2x 3.6V 1.0Ah included. Emergency battery operation 2 hrs. Rescue route signs optionally available and usable as emergency indication luminaire.

Recommended accessories

- Rechg. battery 3.6V | 1000mA, 2 pcs. Item no. 240022
- Set of pictogram transparencies Item no. 240009
- Set of pictogram transparencies Item no. 240010

Variant	Item no.
100lm 6000K CRI>70	
<input type="checkbox"/> white	240004

Pictogram transparencies

Polypropylene (PP)
 W: 35.3 cm H: 16.5 cm



Set of 2 pictograms for inserting (right diagonally upwards / right diagonally downwards)
 1 piece

Variant	Item no.
<input checked="" type="checkbox"/> green	240010



Pictogram transparencies

Polypropylene (PP)
 W: 35.3 cm H: 16.5 cm



Set of 3 pictograms for inserting (top, bottom, right)
 1 piece

Variant	Item no.
<input checked="" type="checkbox"/> green	240009





1001015 745

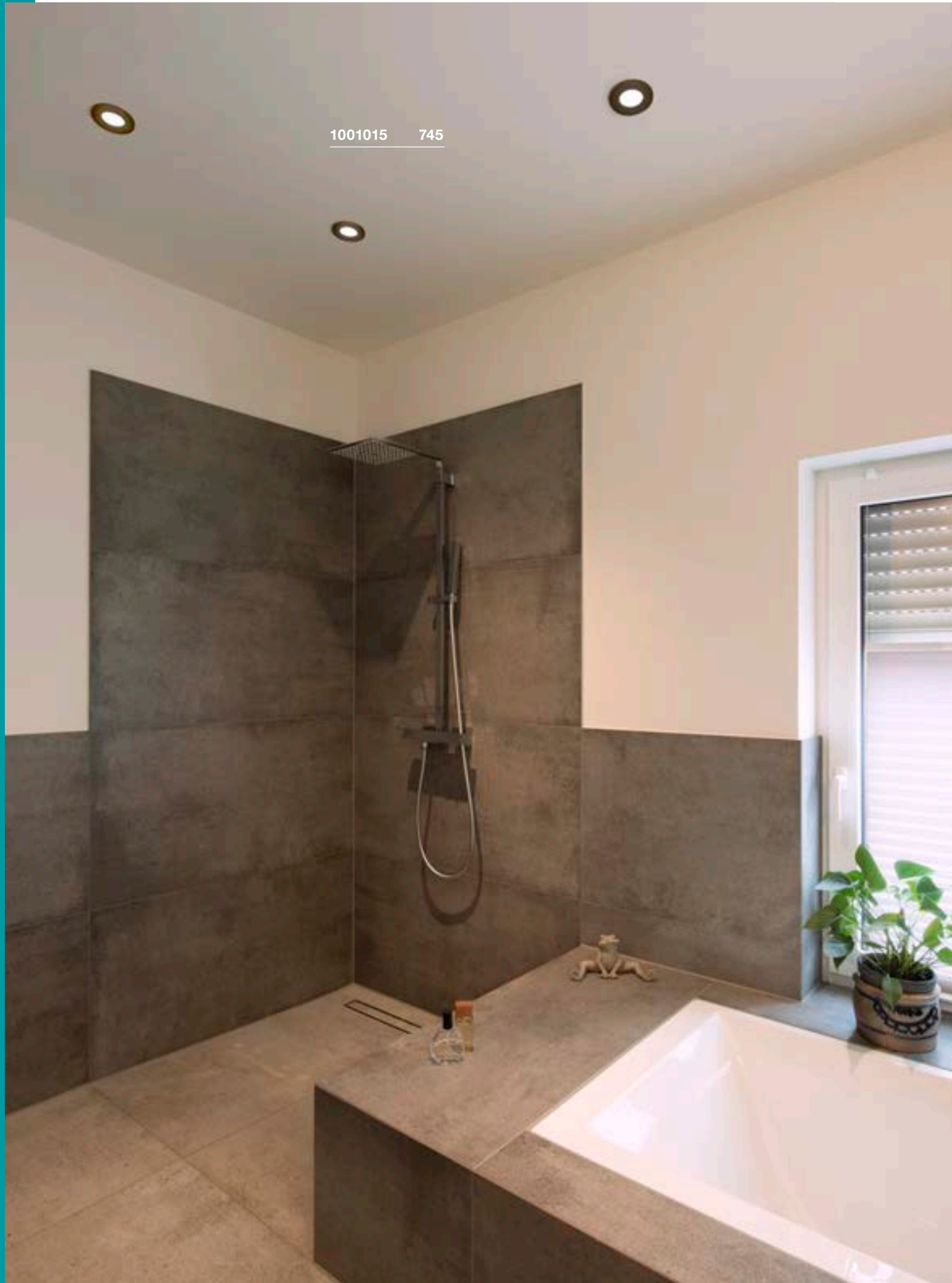



1001017 745

KAMUELA ECO
EL, round, TRIAC

A-A++ Range A++-E



- Fire-resistant for at least 90 minutes in accordance with BS 476-21
- LED service life 35,000h
- IP 65 luminaire with efficient LED echnology

Product details

220-240V ~50Hz
Total consumption: 6.5W
Material: Aluminium / Plastic
Dimmable: Triac C, Triac L

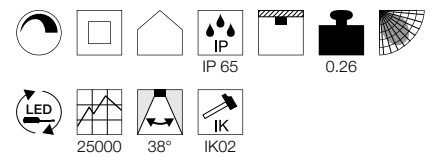

Dimensioned drawing

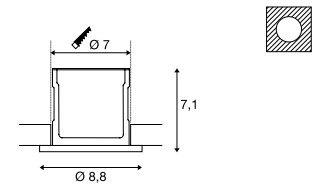

Note



Material thickness, mounting surface: 40 mm max.

Variant	Item no.
400lm 3000K CRI>80	
■ black	1001015
400lm 3000K CRI>80	
□ white	1001016
400lm 4000K CRI>80	
■ black	1001017
400lm 4000K CRI>80	
□ white	1001018





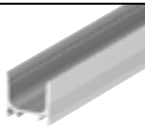
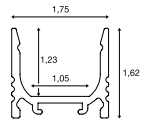
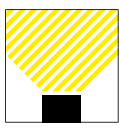

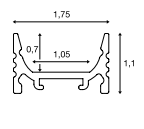
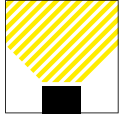
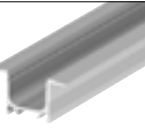
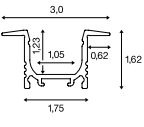
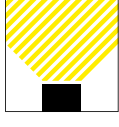



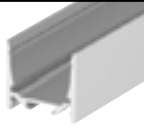
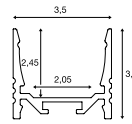
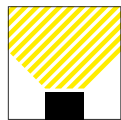
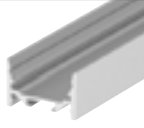
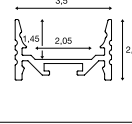
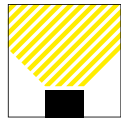
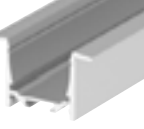
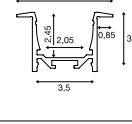
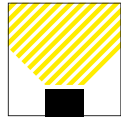
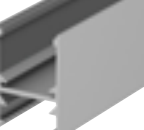
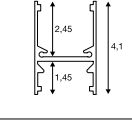
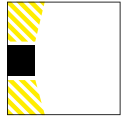

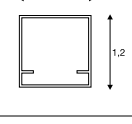
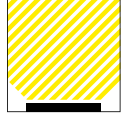
LED PROFILES

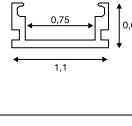
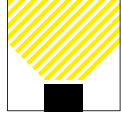
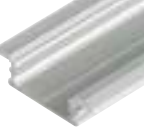
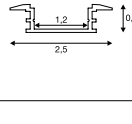
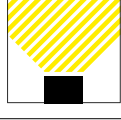
OVERVIEW

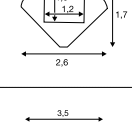
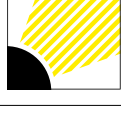
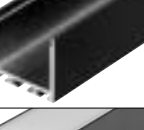
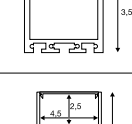
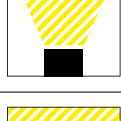

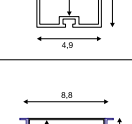
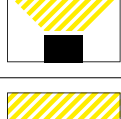
LED profil	Mounting method			Cross-section	Beam angle	Page	
	Surface mounted	Recessed	Pendant				
Standard		✓	-	-			749
GRAZIA 10 Flat		✓	-	-			749
Recessed		-	✓	-			749

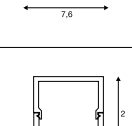
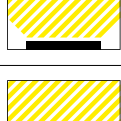

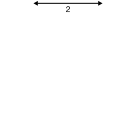
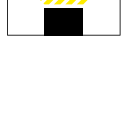
LED profil	Mounting method			Cross-section	Beam angle	Page		
	Surface mounted	Recessed	Pendant					
Standard		✓	-	✓			753	
GRAZIA 20	Flat		✓	-	✓			753
	Recessed		-	✓	-			754
H-PROFILE		✓	-	✓			758	
KENAI		✓	-	-			762	
GLENOS Linear profile 110		✓	-	-			764	
GLENOS Linear recessed profile 250		-	✓	-			766	
GLENOS Corner profile 272		✓	-	-			768	
GLENOS Professional profile 303		✓	-	✓			770	
GLENOS Professional profile 497		✓	-	✓			772	
GLENOS Professional recessed profil 8832		-	✓	-			774	
GLENOS Professional profile 202		✓	-	-			776	

 Suitable LED strips and components can be found on page 778 onwards, and the relevant accessories (power supplies, drivers etc.) from page 842 onwards

GRAZIA 10

SURFACE MOUNTED AND RECESSED PROFILE

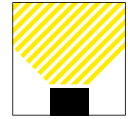

SURFACE MOUNTED PROFILE, STANDARD

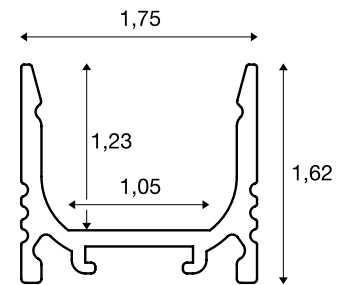

Surface mounted profile, standa d, aluminium, white, black

Length	Colour	Weight (kg)	Item no.
200 cm	aluminium	0.35	1000463
	white	0.46	1000464
	black	0.46	1000465

Material: aluminium, width / height: 1.75/1.62 cm, max. Width of LED strip: 1.0 cm, cover excl.

SURFACE-MOUNTED PROFILE, FLAT

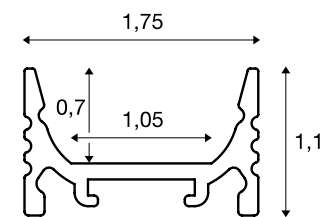

Surface mounted profile, flat, aluminium, wh e, black

Length	Colour	Weight (kg)	Item no.
200 cm	aluminium	0.27	1000460
	white	0.36	1000461
	black	0.36	1000462

Material: aluminium, width / height: 1.75/1.1 cm, max. width of LED strip: 1.0 cm, cover excl.

INSTALLATION PROFILE

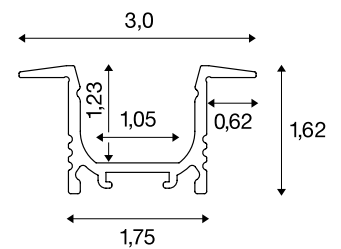
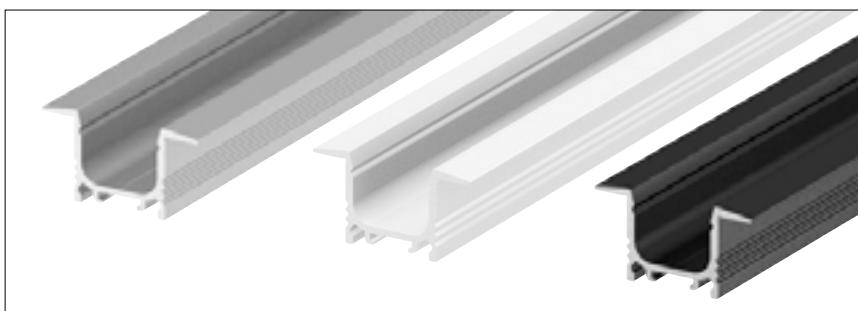

Recessed profile, flat, anodised aluminium, wh e, black

Length	Colour	Weight (kg)	Item no.
200 cm	aluminium	0.42	1000457
	white	0.53	1000458
	black	0.53	1000459

Material: aluminium, width / height: 3.0/1.62 cm, max. width of LED strip: 1.0 cm, cover excl.

GRAZIA 10

ACCESSORIES

COVERS

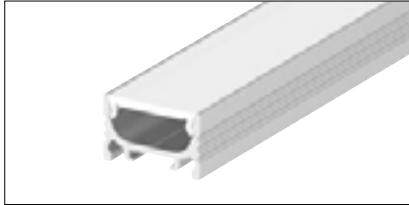

flat, opaqu

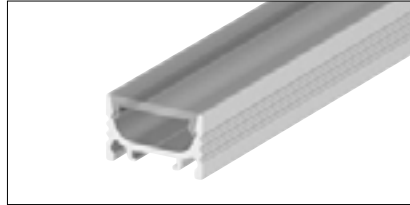

flat, t ansparent

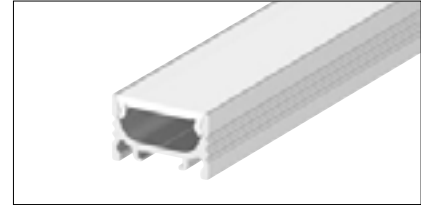

flat, matt t ansparent

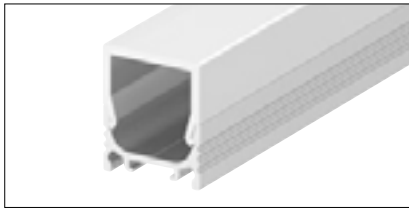

high, opaque (only suitable for surface-mounted profiles)

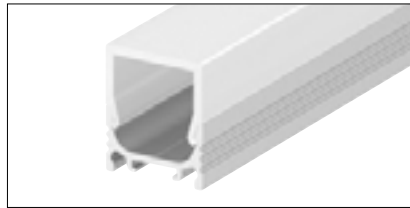

high, matt transparent (only suitable for surface-mounted profiles)

Length	Colour	Material	Item no.
200 cm	flat, opaqu	Plastic PC	1000466
	flat, opaqu	Plastic PMMA	1000468
	flat, t ansparent	Plastic PC	1000467
	flat, matt t ansparent	Plastic PMMA	1000469
	high, opaque *	Plastic PC	1000470
	flat, matt t ansparent *	Plastic PC	1000471

Plastic PMMA/PC:

Profile covers made from PMMA are particularly homogeneous.

Profile covers made from PC are unbreakable and are suitable for applications with high durability demands.

* The high covers are only suitable for GRAZIA 10 surface-mounted profiles, not recessed profiles

MOUNTING CLIPS



Mounting clip, invisible

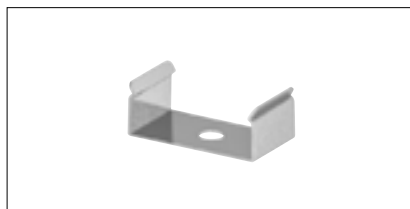

Mounting clip, visible



Mounting clip, 45°

Description	Dimensions	Item no.
Mounting clip, invisible	W/H/D: 1.53/0.3/1 cm	1000487
Mounting clip, visible	W/H/D: 1.87/0.7/1 cm	1000488
Mounting clip, 45°	W/H/D: 1.62/1.62/1 cm	1000489

Material: Stainless Steel, packing unit: 2 pieces

END CAPS FOR SURFACE-MOUNTED PROFILES

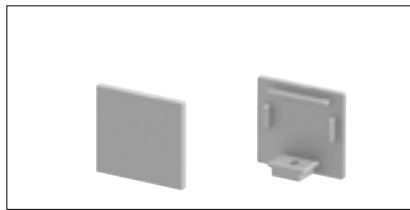

For standard profile, flat cov

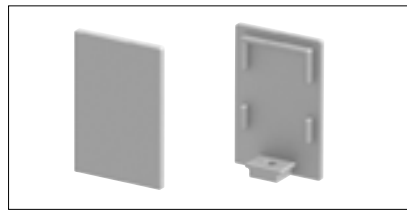

For standard profile, high cover

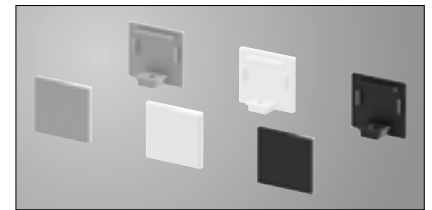

Available colour variants

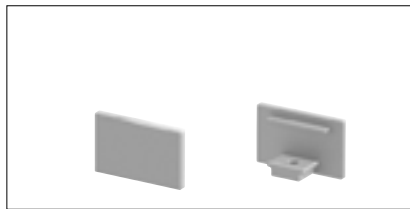

For flat p ofile, flat cov

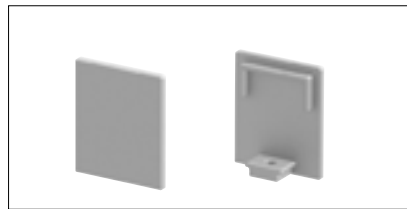

For flat p ofile, high cover

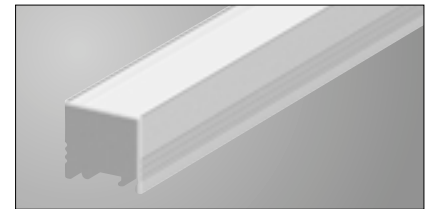

Profile with moun ed end cap

Description	Colour	Visible depth	Item no.
End cap for standard profile flat cover	aluminium	0.2 cm	1000478
	white		1000479
	black		1000480
End cap for standard profile high cover	aluminium	0.2 cm	1000484
	white		1000485
	black		1000486
End cap for flat p ofile, flat cov	aluminium	0.2 cm	1000475
	white		1000476
	black		1000477
End cap for flat p ofile, high cover	aluminium	0.2 cm	1000481
	white		1000482
	black		1000483

Material: aluminium, packing unit: 2 pieces

END CAPS FOR RECESS-MOUNTED PROFILE

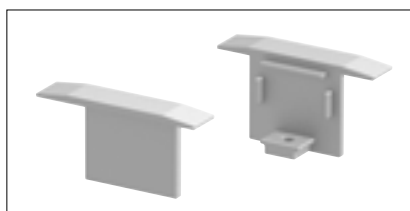

For recess-mounted profil

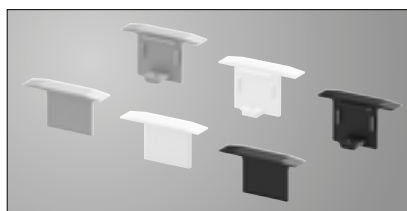

Available colour variants

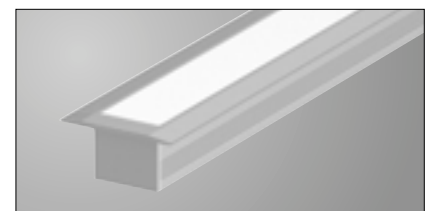

Profile with moun ed end cap

Description	Colour	Visible depth	Item no.
End caps for recess-mounted profil	aluminium	0.7 cm	1000472
	white		1000473
	black		1000474

Material: aluminium, packing unit: 2 pieces



Please note that the visible depth must be subtracted from the profile length when using end caps in order to obtain the required total length.

Visible depth of end caps + profile length = total length

GRAZIA 20

ASSEMBLY PROFILE

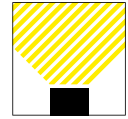

Can also be used as pendant (for pendant suspension see pg. 757)

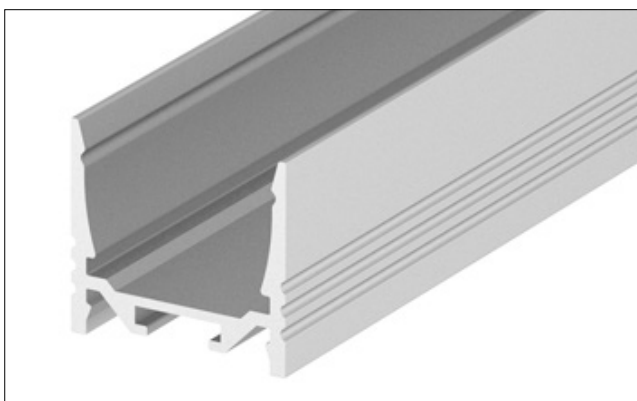

High-quality powder-coated aluminium finish



Available colour variants: aluminium, white, black

STANDARD

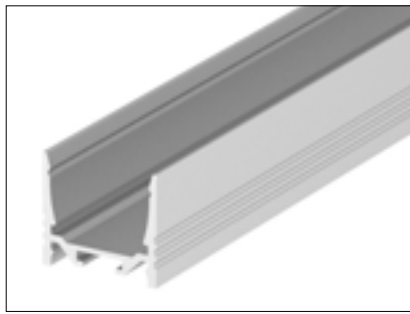

Grooved

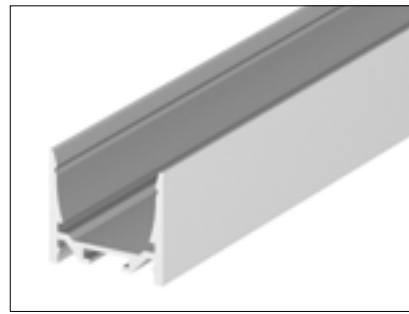

Smooth

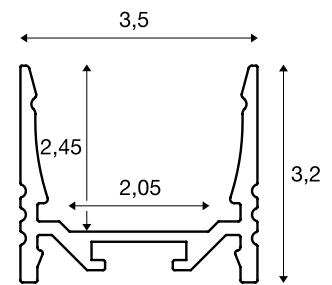

Description	Length	Colour	Weight (kg)	Item no.
Standard, grooved	100 cm	aluminium	0.8	1000508
		white	0.82	1000509
		black	0.82	1000510
	200 cm	aluminium	1.6	1000511
		white	1.64	1000512
		black	1.64	1000513
		aluminium	2.4	1000514
		white	2.46	1000515
		black	2.46	1000516
Standard, smooth	100 cm	aluminium	0.83	1000517
		white	0.85	1000518
		black	0.85	1000519
	200 cm	aluminium	1.66	1000520
		white	1.7	1000521
		black	1.7	1000522
		aluminium	2.49	1000523
		white	2.55	1000524
		black	2.55	1000525

Material: aluminium, width / height: 3.5/3.2 cm, max. width of LED strip: 2.0 cm, cover excl.

FLAT



Grooved



Smooth

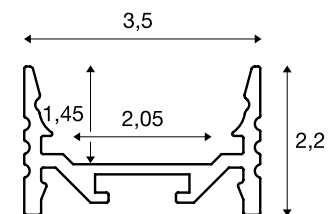

Description	Length	Colour	Weight (kg)	Item no.
Flat, grooved	100 cm	aluminium	0.49	1000499
		white	0.51	1000500
		black	0.51	1000501
	200 cm	aluminium	0.98	1000502
		white	1.02	1000503
		black	1.02	1000504
		aluminium	1.47	1000505
		white	1.53	1000506
		black	1.53	1000507
Flat, smooth	100 cm	aluminium	0.52	1000526
		white	0.54	1000527
		black	0.54	1000528
	200 cm	aluminium	1.04	1000529
		white	1.08	1000530
		black	1.08	1000531
		aluminium	1.56	1000532
		white	1.62	1000533
		black	1.62	1000534

Material: aluminium, width / height: 3.5/2.2 cm, max. width of LED strip: 2.0 cm, cover excl.

GRAZIA 20

INSTALLATION PROFILE

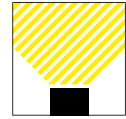

INSTALLATION PROFILE



Installation profile, aluminium, white, black

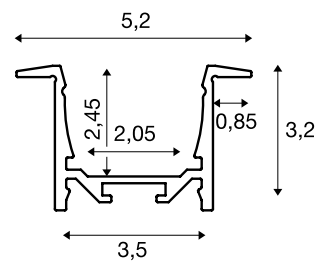

Length	Colour	Weight (kg)	Item no.
100 cm	aluminium	0.76	1000490
	white	0.78	1000491
	black	0.78	1000492
200 cm	aluminium	1.52	1000493
	white	1.56	1000494
	black	1.56	1000495
300 cm	aluminium	2.28	1000496
	white	2.34	1000497
	black	2.34	1000498

Material: aluminium, width / height: 5.2/3.2 cm, max. width of LED strip: 2.0 cm, cover excl.

GRAZIA 20

ACCESSORIES

COVERS

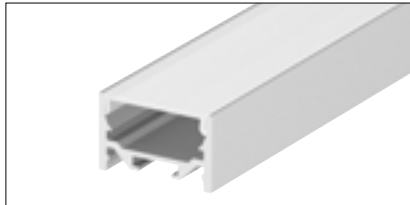

flat, matt transparent

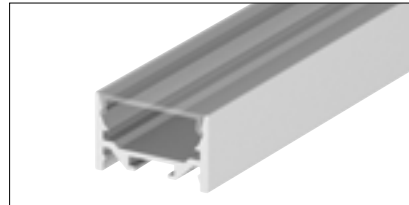

flat, matt transparent

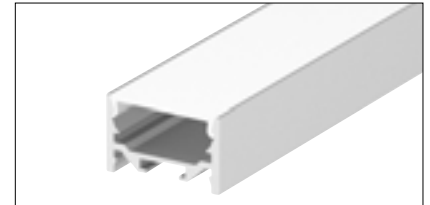

flat, opaqu

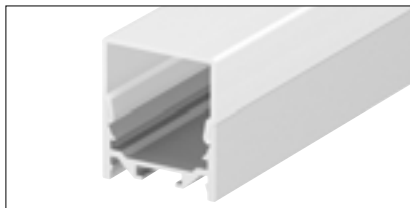

high, matt transparent

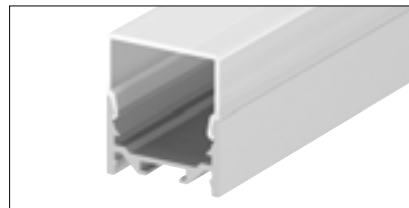

high, opaque

Length	Colour	Material	Item no.
100 cm	flat, matt transparent	Plastic PC	1000538
	flat, matt transparent	Plastic PMMA	1000544
	flat, transparent	Plastic PC	1000541
	flat, opaque	Plastic PMMA	1000547
	flat, matt transparent *	Plastic PMMA	1000553
	high, opaque *	Plastic PC	1000550
200 cm	flat, matt transparent	Plastic PC	1000539
	flat, matt transparent	Plastic PMMA	1000545
	flat, transparent	Plastic PC	1000542
	flat, opaque	Plastic PMMA	1000548
	flat, matt transparent *	Plastic PMMA	1000554
	high, opaque *	Plastic PC	1000551
300 cm	flat, matt transparent	Plastic PC	1000540
	flat, matt transparent	Plastic PMMA	1000546
	flat, transparent	Plastic PC	1000543
	flat, opaque	Plastic PMMA	1000549
	flat, matt transparent *	Plastic PMMA	1000555
	high, opaque *	Plastic PC	1000552

Plastic PMMA/PC:

Profile covers made from PMMA are particularly homogeneous.

Profile covers made from PC are unbreakable and are extremely suitable for applications with high durability demands.

* The high covers are only suitable for GRAZIA 20 surface-mounted profiles, not recessed profiles

LONG CONNECTOR

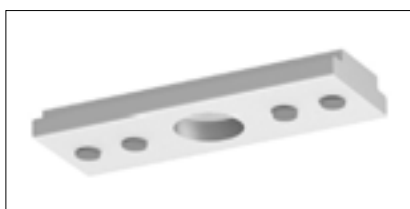

Description	Colour	Dimensions	Item no.
Long connector	aluminium	L/W/H: 3.8/1.4/0.4 cm	1000571

Material: aluminium, packing unit: 2 pieces

GRAZIA 20

ACCESSORIES

END CAPS FOR SURFACE-MOUNTED PROFILE

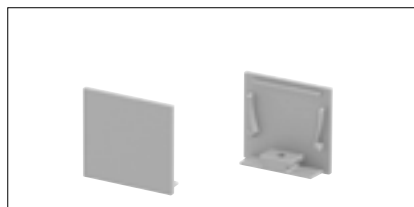

For standard profile, flat cov

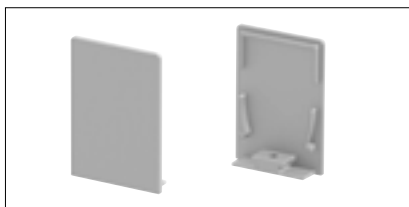

For standard profile, high cove

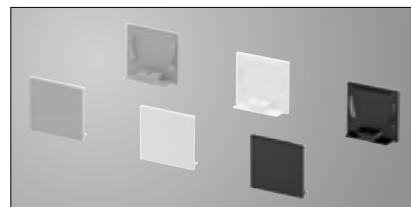

Available colour variants

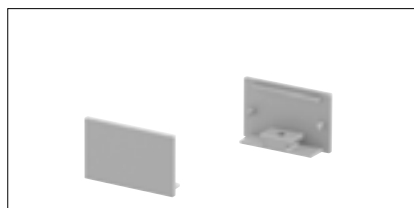

For flat p ofile, flat cov

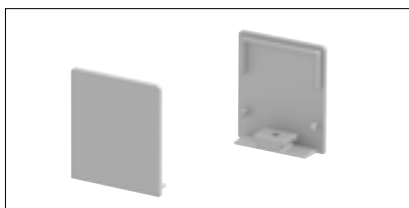

For flat p ofile, high cove

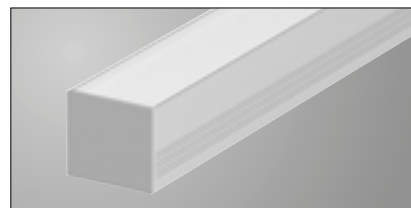

Profile with moun ed end cap

Description	Colour	Visible depth	Item no.
Standard profile, flat cov	aluminium	0.25 cm	1000565
	white		1000566
	black		1000567
Standard profile, high cove	aluminium	0.25 cm	1000568
	white		1000569
	black		1000570
Flat profile, flat cov	aluminium	0.25 cm	1000559
	white		1000560
	black		1000561
Flat profile, high cove	aluminium	0.25 cm	1000562
	white		1000563
	black		1000564

Material: aluminium, packing unit: 2 pieces

i Please note that the visible depth must be subtracted from the profile length when using end caps in order to obtain the required total length.
Visible depth of end caps + profile length = total length

END CAPS FOR RECESS-MOUNTED PROFILE



For recess-mounted profil

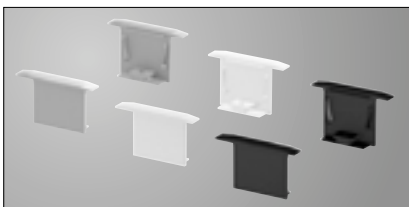

Available colour variants

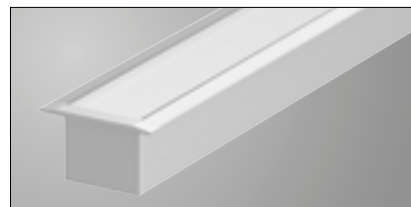

Profile with moun ed end cap

Description	Colour	Visible depth	Item no.
End caps for recess-mounted profil	aluminium	0.085 cm	1000556
	white	0.085 cm	1000557
	black	0.085 cm	1000558

Material: aluminium, packing unit: 2 pieces

i Please note that the visible depth must be subtracted from the profile length when using end caps in order to obtain the required total length.
Visible depth of end caps + profile length = total length

PENDANT SUSPENSION AND MOUNTING CLIPS



Pendant suspension (for surface-mounted profiles only)



Mounting clip, invisible

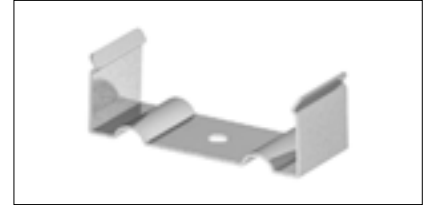

Mounting clip, visible (for grooved surface-mounted profiles only)

Description	Dimensions	Item no.
Pendant suspension *	Pendant L: 200 cm	1000535
Mounting clip, invisible	L/W/H: 2.82/1.2/1.4 cm	1000536
Mounting clip, visible **	L/W/H: 3.65/6.2/1.5 cm	1000537

Material: Stainless Steel, packing unit: 2 pieces

* Pendant suspension is only suitable for surface-mounted profiles

** The visible mounting clip is only suitable for the **GRAZIA 20 standard, grooved** and **GRAZIA 20 flat, grooved** profiles



H-PROFILE

2 m

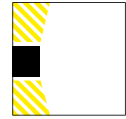



H-PROFILE 2m

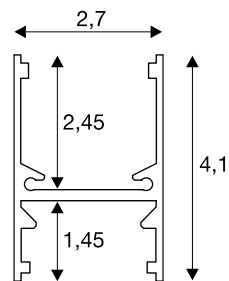
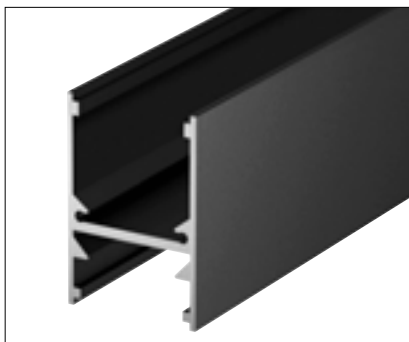

Length	Colour	Weight (kg)	Item no.
200 cm	black	1	1001814
	white		1001816
	aluminium		1001817

Material: aluminium, width / height: 2.7/4.1 cm, max. width of LED strip: 1.6 cm, cover excl.

H-PROFILE

2 m – ACCESSORY

COVER

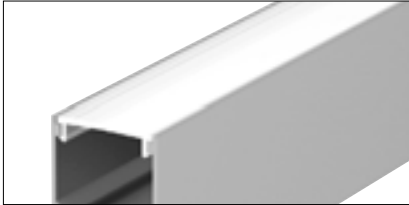

Cover, opaque

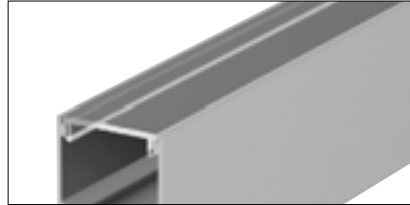

Cover, transparent

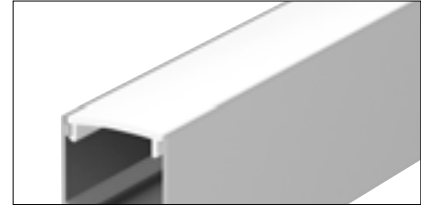

Cover, frosted

Length	Colour	Material	Item no.
200 cm	opaque	Plastic PC	1001813
	transparent	Plastic PC	1001815
	transparent	Plastic PMMA	214350
	matt transparent	Plastic PMMA	214351

Packing unit: 1 piece

END CAPS

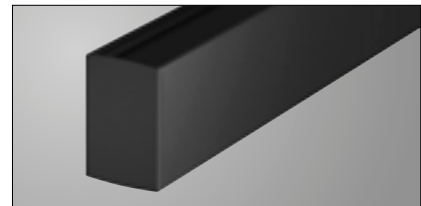

Description	Colour	Visible depth	Item no.
End caps	black	0.14 cm	1001807
	white	0.14 cm	1001808
	grey	0.14 cm	1001809

Material: aluminium, packing unit: 2 pieces

i Please note that the visible depth must be subtracted from the profile length when using end caps in order to obtain the required total length.
Visible depth of end caps + profile length = total length

CONNECTOR

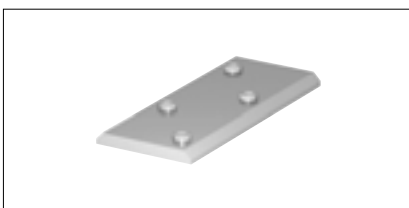

Description	Colour	Dimensions	Item no.
Connector	grey	L/W/H: 5.6/2.4/0.3 cm	1001806

Material: aluminium

MOUNTING ACCESSORIES

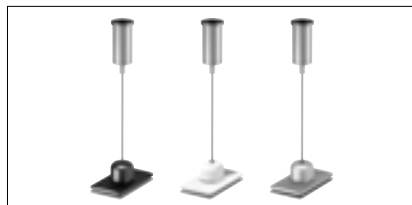

Pendant suspension

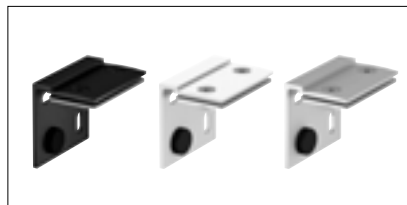

Wall bracket



Adapter for track

Description	Colour	Material	Dimensions	Item no.
Pendant suspension, 2 pieces	black	Aluminium / Steel	L/W/H: 4.4/2.4/2 cm Pendant L: 200 cm	1001796
	white			1001797
	aluminium			1001798
Wall holder, 2 pieces	black	Aluminium / Plastic	L/W/H: 4.4/3.2/4 cm	1001802
	white			1002236
	aluminium			1002237
Adapter for SLV D-TRACK (2-circuit) Track, 5 pieces	silver	Steel	L/W/H: 2/2.2/0.3 cm	1001810

STRAIN RELIEF

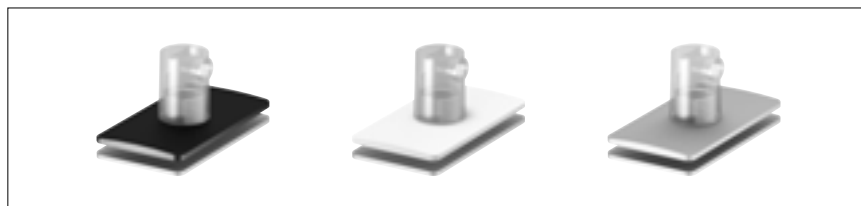

Description	Colour	Dimensions	Item no.
Strain relief	black	L/W/H: 4.4/2.4/2.6 cm	1001799
	white		1001800
	aluminium		1001801

Material: aluminium / Steel, max. cable diameter 6.5 mm, packing unit: 1 piece

CONNECTION BOX



Description	Colour	Dimensions	Item no.
Connection box	black	L/W/H: 37.6/6.6/4.7 cm	1001803
	white		1001804
	grey		1001805

Material: aluminium / Steel, ceiling plate is prepared for installation of operating devices and cables. Operating device and cables available separately. Available installation space for driver max. 6.2 x 25 x 4 cm. Packing unit: 1 piece

KENAI

ASSEMBLY PROFILE

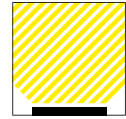

KENAI ASSEMBLY PROFILE

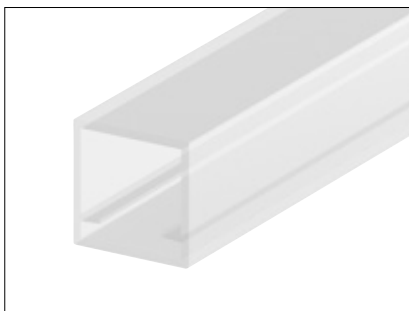

transparent

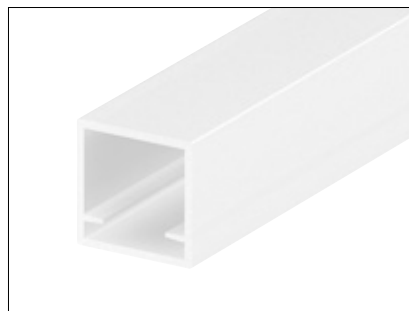

frosted

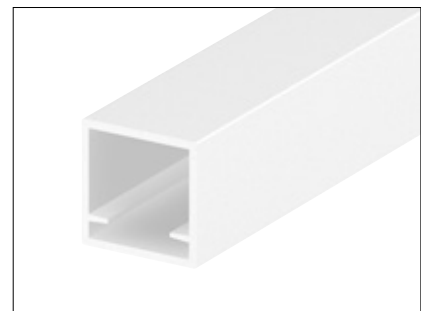

opaque

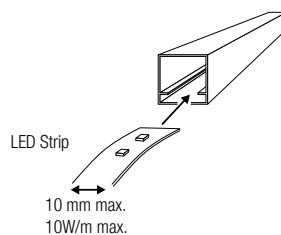
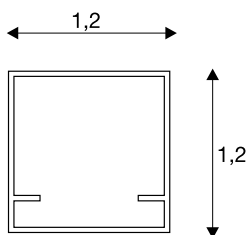

Colour	Material	L (cm)	W (cm)	H (cm)	Weight (kg)	Item no.
transparent	PMMA	200	1.2	1.2	0.1	214100
matt transparent						214101
opaque						214102

Max. width of LED strip: 1.0 cm, cover incl., maximum strip output 10W/m.

KENAI

SURFACE-MOUNTED PROFILE – ACCESSORIES

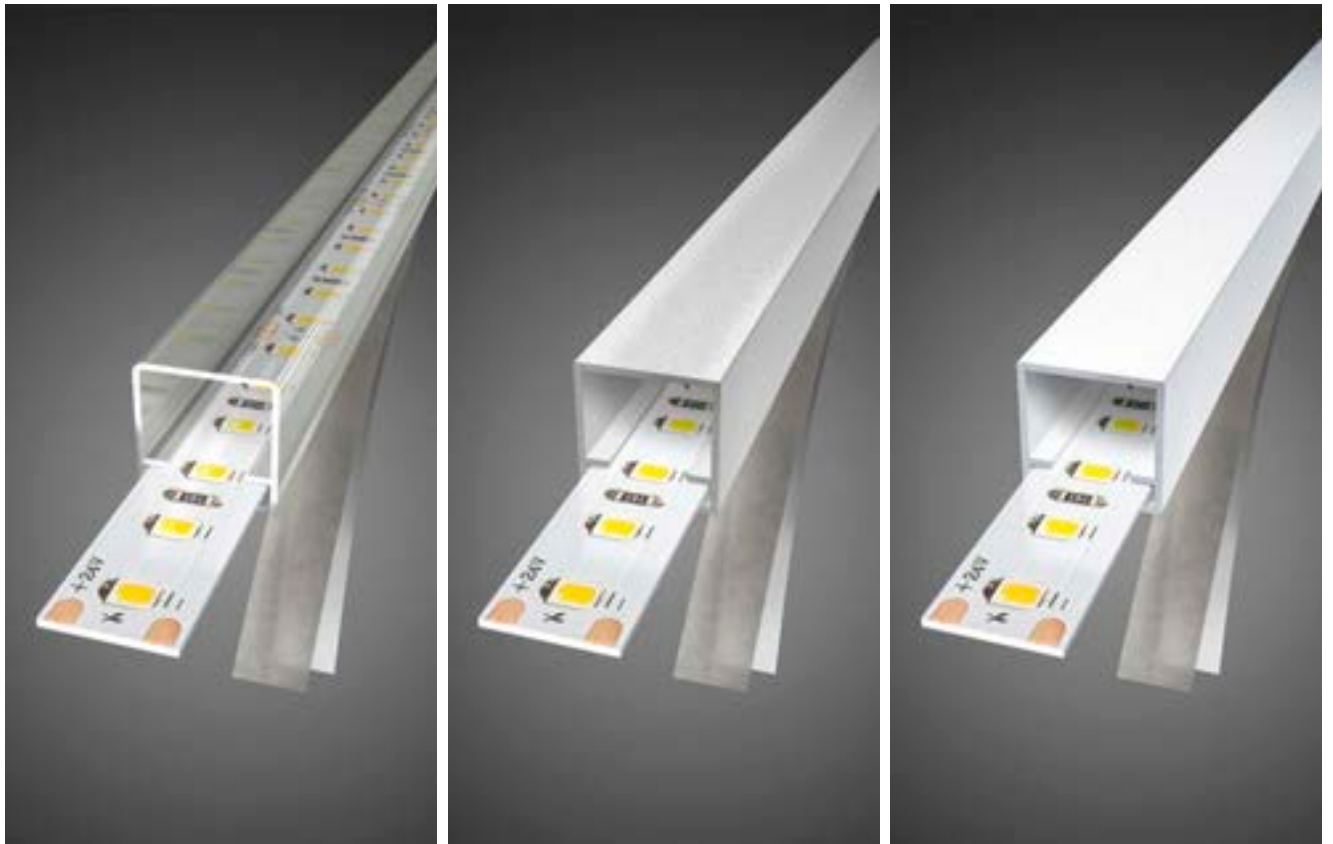

DOUBLE-SIDED ADHESIVE TAPE



Description	Colour	Material	Dimensions	Item no.
Double-sided adhesive tape	transparent	Plastic	L/W: 300/0.9 cm	220000

GLENOS

LINEAR PROFILE 1107

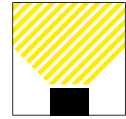

GLENOS linear profile 110

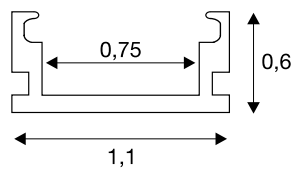

Length	Colour	Weight (kg)	Item no.
200 cm	matt black	0.14	213950
	matt white		213951
	aluminium		213954

Material: aluminium, width / height: 1.1/0.6 cm, max. width of LED strip: 0.75 cm, cover excl.

GLENOS

LINEAR PROFILE 1107 – ACCESSORIES

COVER



Cover, white

Length	Colour	Material	Item no.
200 cm	white	Plastic PC	213962

Plastic PMMA/PC:

Profile covers made from PMMA are particularly homogeneous.

Profile covers made from PC are unbreakable and are suitable for applications with high durability demands.

END CAPS

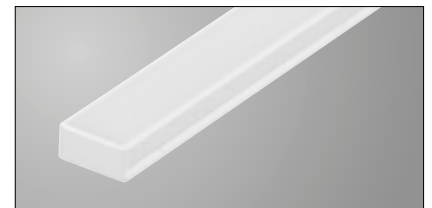
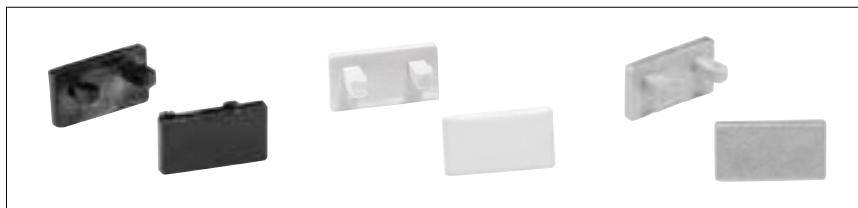

Description	Colour	Visible depth	Item no.
End caps	matt black	0.015 cm	213970
	matt white	0.015 cm	213971
	grey	0.015 cm	213974

Material: Plastic, packing unit: 2 pieces

i Please note that the visible depth must be subtracted from the profile length when using end caps in order to obtain the required total length.
Visible depth of end caps + profile length = total length

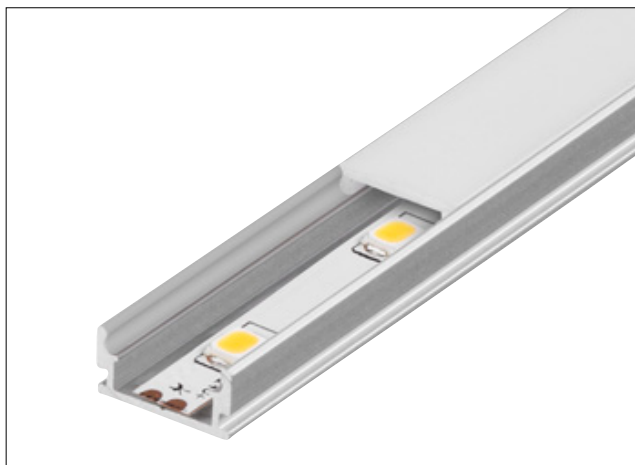

GLENOS linear profile 1107 with glued-in LED strip and cover

GLENOS

LINEAR RECESSED PROFILE 2508

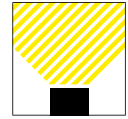

GLENOS

LINEAR RECESSED PROFILE 2508

GLENOS Linear recessed profile 250

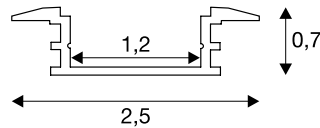

Length	Colour	Weight (kg)	Item no.
200 cm	aluminium	0.58	213862

Material: aluminium, width / height: 2.5/0.7 cm, max. width of LED strip: 1.2 cm, cover excl.

ACCESSORIES

COVER AND END CAPS



Cover, white

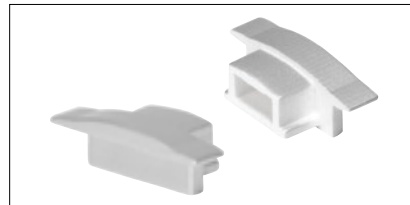

End caps

Description	Colour	Material	Dimensions	Item no.
Cover	white	Plastic PC	L/W/H: 200/1.5/0.5 cm	213822
End caps, 2 pieces	grey	Plastic	L/W/H: 2.4/0.5/0.8 cm Visible depth: 0.05 cm	213874



Please note that the visible depth must be subtracted from the profile length when using end caps in order to obtain the required total length.

Visible depth of end caps + profile length = total length

GLENOS

CORNER PROFILE 2720

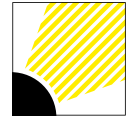

STANDARD



Grooved

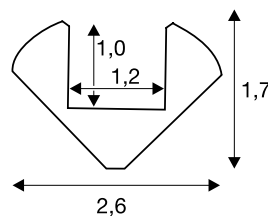

Length	Colour	Weight (kg)	Item no.
200 cm	matt white	0.54	213911
	aluminium		213914

Material: aluminium, width / height: 2.6/1.7 cm, max. width of LED strip: 1.0 cm, cover excl.

GLENOS

CORNER PROFILE 2720 ACCESSORY

COVER

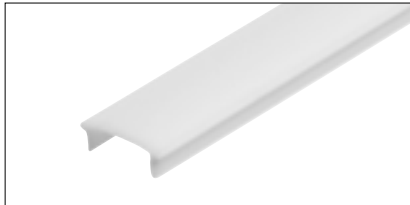

Cover, white

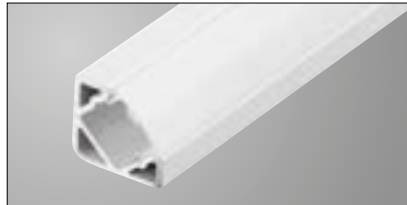

GLENOS corner profile 2720 with cover

Length	Description	W (cm)	H (cm)	Item no.
100 cm	opaque	1.5	0.5	213821
200 cm				213822

Material: Plastic PC, packing unit: 1 piece

END CAPS

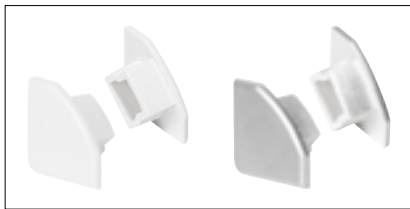

Description	Colour	Visible depth	Item no.
End caps	matt white	0.2 cm	213931
	grey	0.2 cm	213934

Material: Plastic, packing unit: 2 pieces



Please note that the visible depth must be subtracted from the profile length when using end caps in order to obtain the required total length.

Visible depth of end caps + profile length = total length

MOUNTING CLIP



Description	Dimensions	Item no.
Mounting clip	L/W/H: 2.4/2.1/2 cm	213939

Material: Stainless Steel, packing unit: 2 pieces

GLENOS

PROFESSIONAL PROFILE 3030

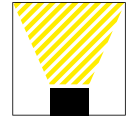

GLENOS Professional profile 303

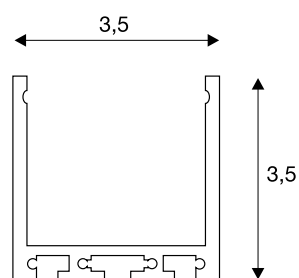

Length	Colour	Weight (kg)	Item no.
200 cm	matt black	1.4	213620
	matt white		213621
	grey		213624
300 cm	matt black	2.1	213630
	matt white		213631
	grey		213634

Material: aluminium, width / height: 3.5/3.5 cm, max. width of LED strip: 3 cm, cover excl.

GLENOS

PROFESSIONAL PROFILE 3030 ACCESSORY

COVER



Length	Description	W (cm)	H (cm)	Item no.
200 cm	Polycarbonate (PC)	3.3	0.5	213642
300 cm				213643

Material: Plastic PC, packing unit: 1 piece

END CAPS



Description	Colour	Visible depth	Item no.
End caps	matt black	0.2 cm	213650
	matt white	0.2 cm	213651
	grey	0.2 cm	213654

Material: Zinc, packing unit: 2 pieces



Please note that the visible depth must be subtracted from the profile length when using end caps in order to obtain the required total length.
Visible depth of end caps + profile length = total length

SUSPENSION SET

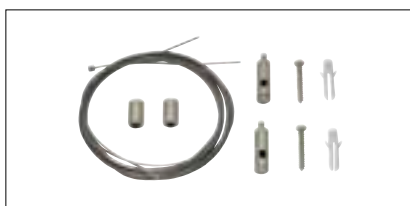

Description	Colour	Dimensions	Item no.
Suspension set	chrome	Pendant L: 250 cm	213488

Material: Steel, packing unit: 1 piece

GLENOS

PROFESSIONAL PROFILE 4970

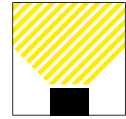

GLENOS Professional profile 497

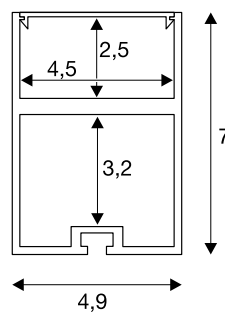

Length	Colour	Weight (kg)	Item no.
200 cm	matt black	3	213470
	white		213471
	aluminium		213474

Material: aluminium / Plastic PC, width / height: 4.9/7 cm, max. width of LED strip: 3.7 cm, cover incl.

GLENOS

PROFESSIONAL PROFILE 4970 ACCESSORY

END CAPS

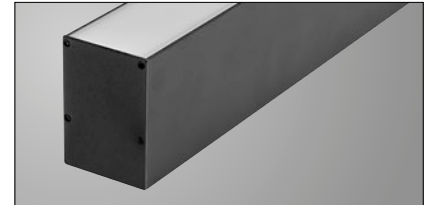

Description	Colour	Visible depth	Item no.
End caps	matt black	0.8 cm	213480
	white	0.8 cm	213481
	aluminium	0.8 cm	213484

Material: Zinc, packing unit: 2 pieces



Please note that the visible depth must be subtracted from the profile length when using end caps in order to obtain the required total length.

Visible depth of end caps + profile length = total length

CONNECTOR



Description	Colour	Dimensions	Item no.
Connector for aluminium profile, gal.	grey	L/W/H: 10/0.95/0.3 cm	213489

Material: Steel, packing unit: 1 piece

SUSPENSION SET

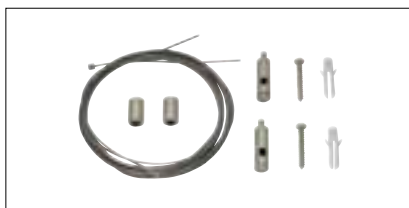

Description	Colour	Dimensions	Item no.
Suspension set	chrome	Pendant L: 250 cm	213488

Material: Steel, packing unit: 1 piece

POWER SUPPLY



Description	Colour	Dimensions	Item no.
LED power supply 24V 60W	white	L/W/H: 28/3/2.2 cm	977399

Material: Steel / Plastic, packing unit: 1 piece

GLENOS

PROFESSIONAL RECESSED PROFILE 8832

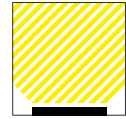

GLENOS Professional recessed profile 883

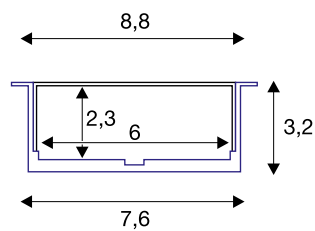
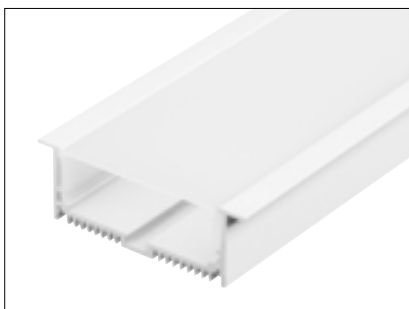

Length	Colour	Weight (kg)	Item no.
200 cm	white aluminium	2.3	213511 213514

Material: aluminium / Polycarbonate (PC), width / height: 8.8/3.2 cm, max. width of LED strip: 2 cm, material thickness of mounting surface: max. 24 mm, cover incl. To ensure that cooling takes place, do not glue the strip in the middle.

GLENOS

PROFESSIONAL INSTALLATION PROFILE 8832 ACCESSORY

END CAPS

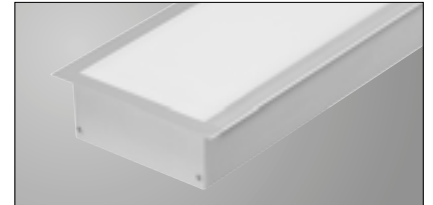
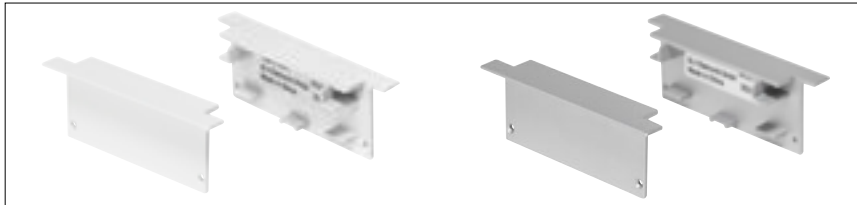

Description	Colour	Visible depth	Item no.
End caps	white	1.80 cm	213521
	aluminium	1.80 cm	213524

Material: Zinc, packing unit: 2 pieces



Please note that the visible depth must be subtracted from the profile length when using end caps in order to obtain the required total length.

Visible depth of end caps + profile length = total length

MOUNTING BRACKET



Description	Dimensions	Item no.
Mounting bracket	L/W/H: 11.2/2/3 cm	213529

Material: aluminium, packing unit: 2 pieces

GLENOS

PROFESSIONAL PROFILE 2020

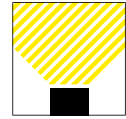

GLENOS Professional profile 202

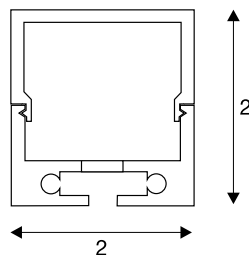

Length	Colour	Weight (kg)	Item no.
200 cm	black	0.56	213440
	white		213441
	aluminium / white		213444

Material: aluminium / Polycarbonate, width / height: 2.0/2.0 cm, max. width of LED strip: 1.6 cm, cover incl., diffuser incl

GLENOS

PROFESSIONAL PROFILE 2020 ACCESSORY



END CAPS AND LONGITUDINAL CONNECTORS

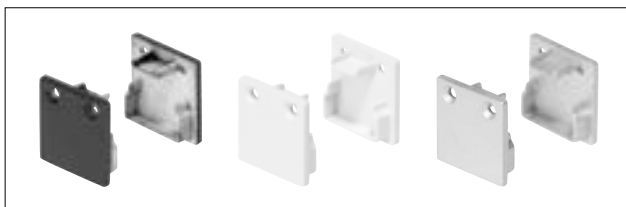

End caps



Long connector

Description	Colour	Material	Dimensions	Item no.
End caps, 2 pieces	black	Zinc	L/W/H: 2/0.2/2 cm	213450
	white		Visible depth: 0.2 cm	213451
	grey			213454
Long connector, 1 piece	aluminium	Aluminium	L/W/H: 20/1.3/0.3 cm	213459



Please note that the visible depth must be subtracted from the profile length when using end caps in order to obtain the required total length.

Visible depth of end caps + profile length = total length

IMPRESSIVE LINE-UP.

LED STRIP LIGHTS AND LIGHT BARS FOR
A SPECIAL ATMOSPHERE.

Want to introduce a bit of variety? LED strip lights and light bars are modern and extraordinary design elements giving rooms a special atmosphere. The elongated luminaires with many different colours make a good impression as signposts.

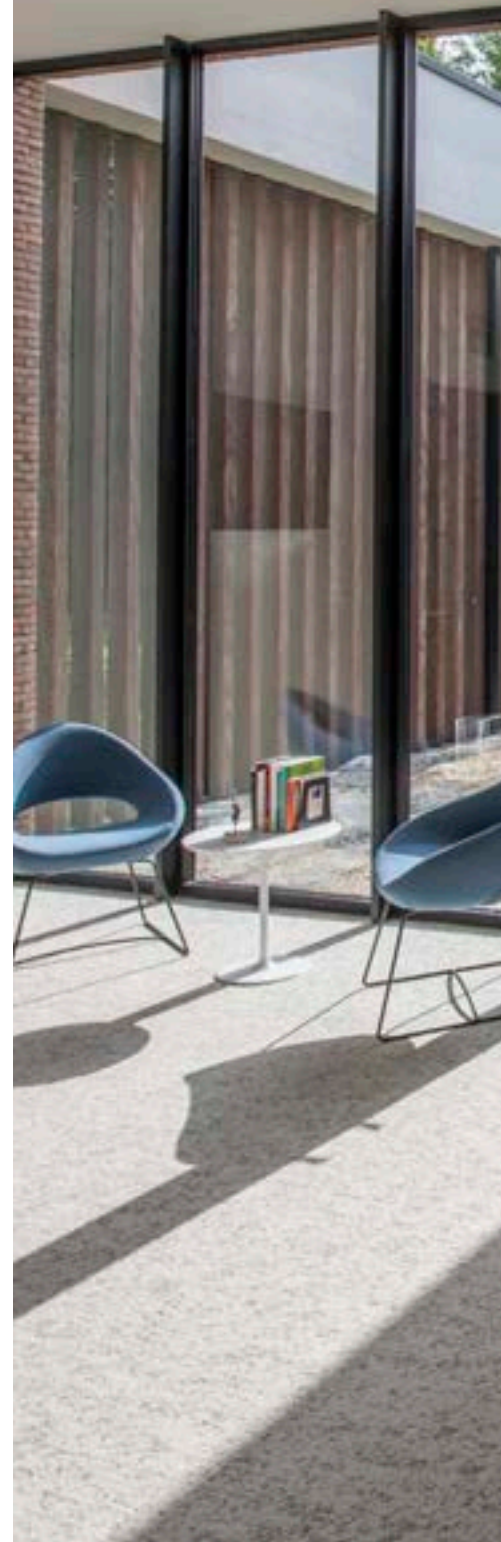



213511 + 1002989 774 + 801



PROFILE STRIP, STANDARD

OVERVIEW

Detailed information about the products can be found on the specific catalogue page



		Profile strip, standard			
Lumen per meter		850lm/m	1000lm/m	1200lm/m	2000lm/m
LEDs per meter		120 LEDs/m		180 LEDs/m	
Colour rendering index		CRI>80			
					
Colour temperature	2700K	552732	552742	552752	552762
Colour temperature	3000K	552733	552743	552753	552763
Colour temperature	4000K	552734	552744	552754	552764
Catalogue page		783	783	783	783
LED strips suitable LED profile					
GRAZIA 10	Recessed	✓	✓	✓	—
	Flat	✓	✓	✓	✓
	Standard	✓	✓	✓	✓
GRAZIA 20	Recessed	✓	✓	✓	✓
	Flat, smooth	✓	✓	✓	✓
	Flat, grooved	✓	✓	✓	✓
	Standard, smooth	✓	✓	✓	✓
	Standard, grooved	✓	✓	✓	✓



Suitable profiles and components can be found on page 746 onwards and the relevant accessories (power supplies, drivers etc.) from page 842 onwards



Profile strip, standa d

750lm/m	1600lm/m	1600lm/m
180 LEDs/m		120 LEDs/m
CRI>80		CRI 90
		
552772	552782	552792
552773	552783	552793
552774	552784	552794
782	782/783	782/783
✓	—	✓
✓	—	✓
✓	✓	✓
✓	—	✓
✓	✓	✓
✓	✓	✓
✓	✓	✓
✓	✓	✓

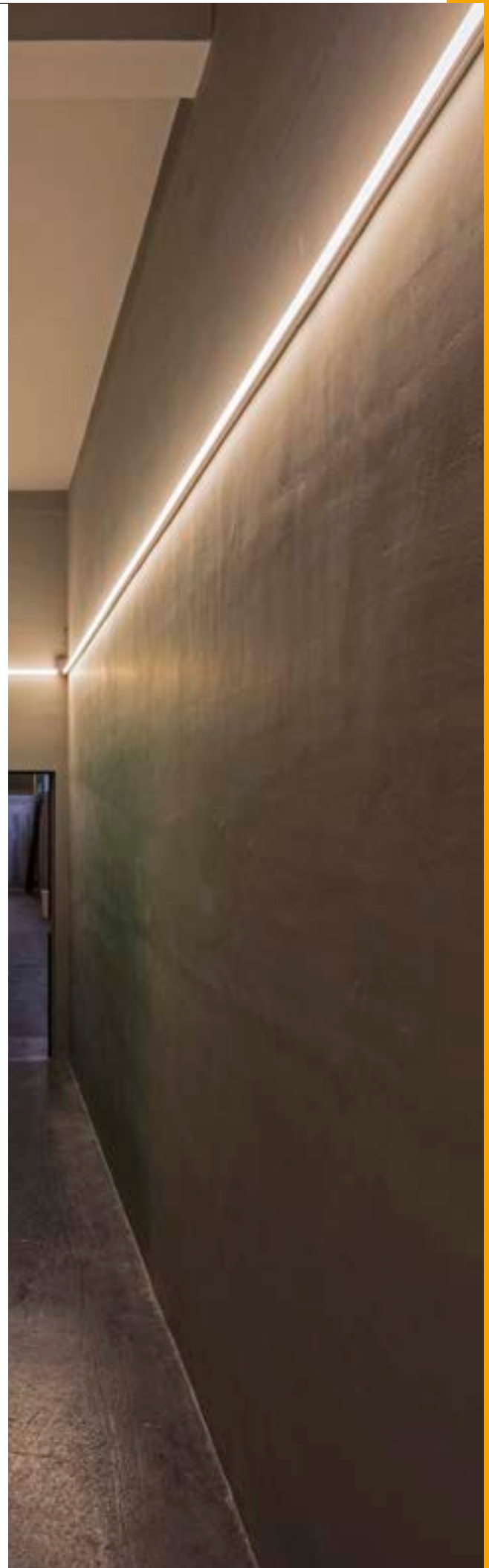

PROFILE STRIP, STANDARD

24V



PROFILE STRIP, STANDARD, 24V



180 LEDs per m
 Width / height: 1/0.2 cm
 LED spacing: 0.55 cm
 Can be separated every 3.4 cm
 Minimum bend radius: 3.8 cm

3 m, CRI>80

Colour temperature	Luminous flu (lm)	Output (W)	Colour rend. index (CRI)	Colour consistency	L (cm)	Energy efficien index	Item no.
2700K	2250	25	>80	3SDCM	300	A+	552772
	4800	55				A	552782
3000K	2250	25				A+	552773
	4800	50				A+	552783
4000K	2250	25				A+	552774
	4800	45				A+	552784

To obtain consistent light output from a length of 1.5 m, we recommend supplying power the strips at both ends.
 For lengths in excess of 3 m, a new power supply must be added.

PROFILE STRIP, STANDARD, 24V



120 LEDs per m
 Width / height: 1/0.2 cm
 LED spacing: 0.8 cm
 Can be separated every 5 cm
 Minimum bend radius: 3.8 cm

3 m, CRI>80

Colour temperature	Luminous flu (lm)	Output (W)	Colour rend. index (CRI)	Colour consistency	L (cm)	Energy efficien index	Item no.
2700K	2550	30	>80	3SDCM	300	A	552732
	3000	40				A	552742
	3600	45				A	552752
	6000	80				A	552762
3000K	2550	25				A+	552733
	3000	35				A	552743
	3600	40				A	552753
	6300	75				A	552763
4000K	2550	25				A+	552734
	3000	30				A+	552744
	3600	35				A+	552754
	6600	70				A	552764

For lengths in excess of 2.5 m, a power supply must be provided at both ends. For lengths in excess of 5 m, a new power supply must be added.

3 m, CRI>90

Colour temperature	Luminous flu (lm)	Output (W)	Colour rend. index (CRI)	Colour consistency	L (cm)	Energy efficien index	Item no.
2700K	4800	65	>90	3SDCM	300	A	552792
3000K							552793
4000K							552794

To obtain consistent light output from a length of 1.5 m, we recommend supplying power the strips at both ends.
 For lengths in excess of 3 m, a new power supply must be added.

PROFILE STRIP, STANDARD, 24V ACCESSORIES



Power supply, 50 cm cable



Direct connector

Variant	Max. perm. current	Material	L (cm)	W (cm)	H (cm)	Item no.
<input type="checkbox"/> Power supply, 1 piece	3A	Plastic	2	1	0.4	1002141
<input type="checkbox"/> Direct connector, 1 piece	3A	Plastic	2.3	1	0.4	1002142







To ensure that heat is dissipated, the LED strips must be glued into an aluminium profile
 There is adhesive tape on the rear of the LED strips.

PROFILE STRIP, GRAND

OVERVIEW

Detailed information about the products can be found on the specific catalogue page

		Profile strip, G and				
Lumen per meter		1600lm/m	2000lm/m	3000lm/m	3700lm/m	2600lm/m
LEDs per meter		240 LEDs/m				
Colour rendering index		CRI>80				CRI 90
						
Colour temperature	2700K	552802	552812	552822	552832	552852
Colour temperature	3000K	552803	552813	552823	552833	552853
Colour temperature	4000K	552804	552814	552824	552834	552854
Catalogue page		787	787	787	787	787
LED strips suitable LED profile	Recessed	—	—	—	—	—
	Flat	—	—	—	—	—
	Standard	—	—	—	—	—
GRAZIA 20	Recessed	✓	✓	✓	—	✓
	Flat, smooth	✓	✓	✓	✓	✓
	Flat, grooved	✓	✓	✓	✓	✓
	Standard, smooth	✓	✓	✓	✓	✓
	Standard, grooved	✓	✓	✓	✓	✓



Suitable profiles and components can be found on page 746 onwards and the relevant accessories (power supplies, drivers etc.) from page 842 onwards



PROFILE STRIP, GRAND

24V



PROFILE STRIP, GRAND, 24V



240 LEDs per m
 Width / height: 2/0.2 cm
 LED spacing: 0.4 cm
 Can be separated every 2.5 cm
 Minimum bend radius: 3.8 cm

2 m, CRI>80

Colour temperature	Luminous flu (lm)	Output (W)	Colour rend. index (CRI)	Colour consistency	L (cm)	Energy efficien index	Item no.
2700K	7400	92	>80	4SDCM	200	A+	552832
3000K		102					552833
4000K		84					552834

To obtain consistent light output from a length of 1 m, we recommend supplying power the strips at both ends.
 For lengths in excess of 2 m, a new power supply must be added.

3 m, CRI>80

Colour temperature	Luminous flu (lm)	Output (W)	Colour rend. index (CRI)	Colour consistency	L (cm)	Energy efficien index	Item no.
2700K	4800	52	>80	4SDCM	300	A+	552802
	6000	68					552812
	9000	102					552822
3000K	4800	52				A+	552803
	6000	68					552813
	9000	105					552823
4000K	4800	48				A+	552804
	6000	62					552814
	9000	96					552824

To obtain consistent light output from a length of 1.5m, we recommend supplying power the strips at both ends.
 For lengths in excess of 3 m, a new power supply must be added.

3 m, CRI>90

Colour temperature	Luminous flu (lm)	Output (W)	Colour rend. index (CRI)	Colour consistency	L (cm)	Energy efficien index	Item no.
2700K	7800	114	>90	6SDCM	300	A	552852
3000K		106					552853
4000K		100					552854

For lengths in excess of 1.5 m, a power supply must be provided at both ends. For lengths in excess of 3 m, a new power supply must be added.

PROFILE STRIP, GRAND, 24V ACCESSORIES

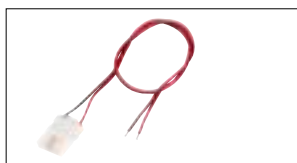

Power supply, 50 cm cable



Direct connector

Variant	Max. perm. current	Material	L (cm)	W (cm)	H (cm)	Item no.
<input type="checkbox"/> Power supply, 1 piece	3A	Plastic	2	2	0.4	1002143
<input type="checkbox"/> Direct connector, 1 piece	3A	Plastic	2.3	2	0.4	1002144







To ensure that heat is dissipated, the LED strips must be glued into an aluminium profile
 There is adhesive tape on the rear of the LED strips.



OTHER LED STRIPS

OVERVIEW

Detailed information about the products can be found on the specific catalogue page

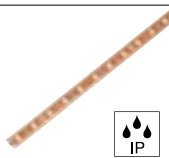

	PROFILE STRIP X-SLIM				PROFILE STRIP SELECT
	-	300lm/m	400lm/m	500lm/m	800lm/m
Lumen per meter	-	300lm/m	400lm/m	500lm/m	800lm/m
LEDs per meter	60 LEDs/m	120 LEDs/m			
Colour rendering index	-	CRI>80			
LED strip width	0.5 cm				0.8 cm
					
Colour temperature	2700K	552702	552712	552722	552692
Colour temperature	3000K	552703	552713	552723	552693
Colour temperature	4000K	552704	552714	552724	552694
Colour temperature	Blue	552727			
Catalogue page	793	793	793	793	795

FLEX ROLL

Lumen per meter	300lm/m
LEDs per meter	60 LEDs/m
Colour rendering index	CRI>80
LED strip width	
	
	
Colour temperature	2700K
Colour temperature	3000K
Colour temperature	4000K
Colour temperature	Blue
Catalogue page	812













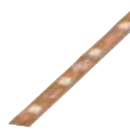

Suitable profiles and components can be found on page 746 onwards and the relevant accessories (power supplies, drivers etc.) from page 842 onwards



		LED STRIP		
Lumen per meter		925lm/m	1000lm/m	1200lm/m
LEDs per meter		60 LEDs/m		
Colour rendering index		CRI>80		
LED strip width		1 cm		
				
Colour temperature	2700K	552442		
Colour temperature	3000K		552443	
Colour temperature	5000K			552445
Catalogue page		798	798	798

		FLEXLED		
Lumen per meter		500lm/m	510lm/m	570lm/m
LEDs per meter		60 LEDs/m		
Colour rendering index		CRI>80		
LED strip width		0.8 cm		
				
Colour temperature	2700K	552422		
Colour temperature	3000K		552423	
Colour temperature	5000K			552425
Catalogue page		797	797	797





		FLEXLED ROLL			FLEXLED		
Lumen per meter		370lm/m			385lm/m	395lm/m	470lm/m
LEDs per meter		60 LEDs/m			60 LEDs/m		
Colour rendering index		CRI>80			CRI>80		
LED strip width		1 cm			0.6 cm		
							
Colour temperature	2700K	552120			552522		
Colour temperature	3000K		552122			552523	
Colour temperature	5000K			552121			552525
Catalogue page		799	799	799	805	805	805

		FLEXLED STRIP					
Lumen per meter		17600lm/m	19200lm/m	21600lm/m	1050lm/m	1200lm/m	1280lm/m
LEDs per meter		48 LEDs/m			120 LEDs/m		
Colour rendering index		CRI>90			CRI>80		
LED strip width		1 cm					
							
Colour temperature	2200K	1002996			1001972		
Colour temperature	2700K		1002997			1002026	
Colour temperature	3000K		1002998			1002027	
Colour temperature	4000K			1002999			1002028
Catalogue page		801	801	801	800	800	800

		FLEXSTRIP LED HIGH LUMEN		
Lumen per meter		1900lm/m	1940lm/m	2150lm/m
LEDs per meter		120 LEDs/m		
Colour rendering index		CRI>80		
LED strip width		1 cm		
				
Colour temperature	2700K	552482		
Colour temperature	3000K		552483	
Colour temperature	5000K			552485
Catalogue page		803	803	803



KELVIN CONTROL STRIP		
Lumen per meter	627-1307lm/m	1174-2410lm/m
LEDs per meter	240lm/m	
Colour rendering index	CRI>80	
LED strip width	1 cm	
		
Colour temperature	2700-6500K	552863
Catalogue page	807	807

	FLEXSTRIP LED RGB	FLEXLED ROLL RGB	FLEXLED ROLL MULTICOLOUR RGBW
Colour temperature	RGB	RGB	RGBW
LED strip width	1 cm	2 cm	1.2 cm
			
LEDs per meter	48 LEDs/m		
LEDs per meter	60 LEDs/m	552649	552453
LEDs per meter	120 LEDs/m		1001971
Catalogue page	809	811	810



i Suitable profiles and components can be found on page 746 onwards and the relevant accessories (power supplies, drivers etc.) from page 842 onwards

PROFILE STRIP X-SLIM

24V



PROFILE STRIP X-SLIM, 24V



120 LEDs per m
 Width / height: 0.5/0.2 cm
 LED spacing: 0.8 cm
 Can be separated every 5 cm
 Minimum bend radius: 3.8 cm
 Extra-narrow LED strip

3 m, CRI>80

Colour temperature	Luminous flu (lm)	Output (W)	Colour rend. index (CRI)	Colour consistency	L (cm)	Energy efficien index	Item no.
2700K	900	8	>80	3SDCM	300	A+	552702
	1200	12				A+	552712
	1500	15				A+	552722
3000K	900	6				A++	552703
	1200	12				A+	552713
	1500	15				A+	552723
4000K	900	7				A++	552704
	1200	12				A+	552714
	1500	15				A+	552724

To obtain consistent light output from a length of 1.5 m, we recommend supplying power the strips at both ends.
 For lengths in excess of 3 m, a new power supply must be added.

PROFILE STRIP X-SLIM, 24V



60 LEDs per m
 Width / height: 0.5/0.3 cm
 LED spacing: 0.8 cm
 Can be separated every 10 cm
 Minimum bend radius: 3.8 cm
 Extra-narrow LED strip

3 m

Colour temperature	Output (W)	L (cm)	Item no.
blue	12	300	552727

To obtain consistent light output from a length of 1.5 m, we recommend supplying power the strips at both ends.
 For lengths in excess of 3 m, a new power supply must be added.



i To ensure that heat is dissipated, the LED strips must be glued into an aluminium profile
 There is adhesive tape on the rear of the LED strips.

PROFILE STRIP SELECT

24V

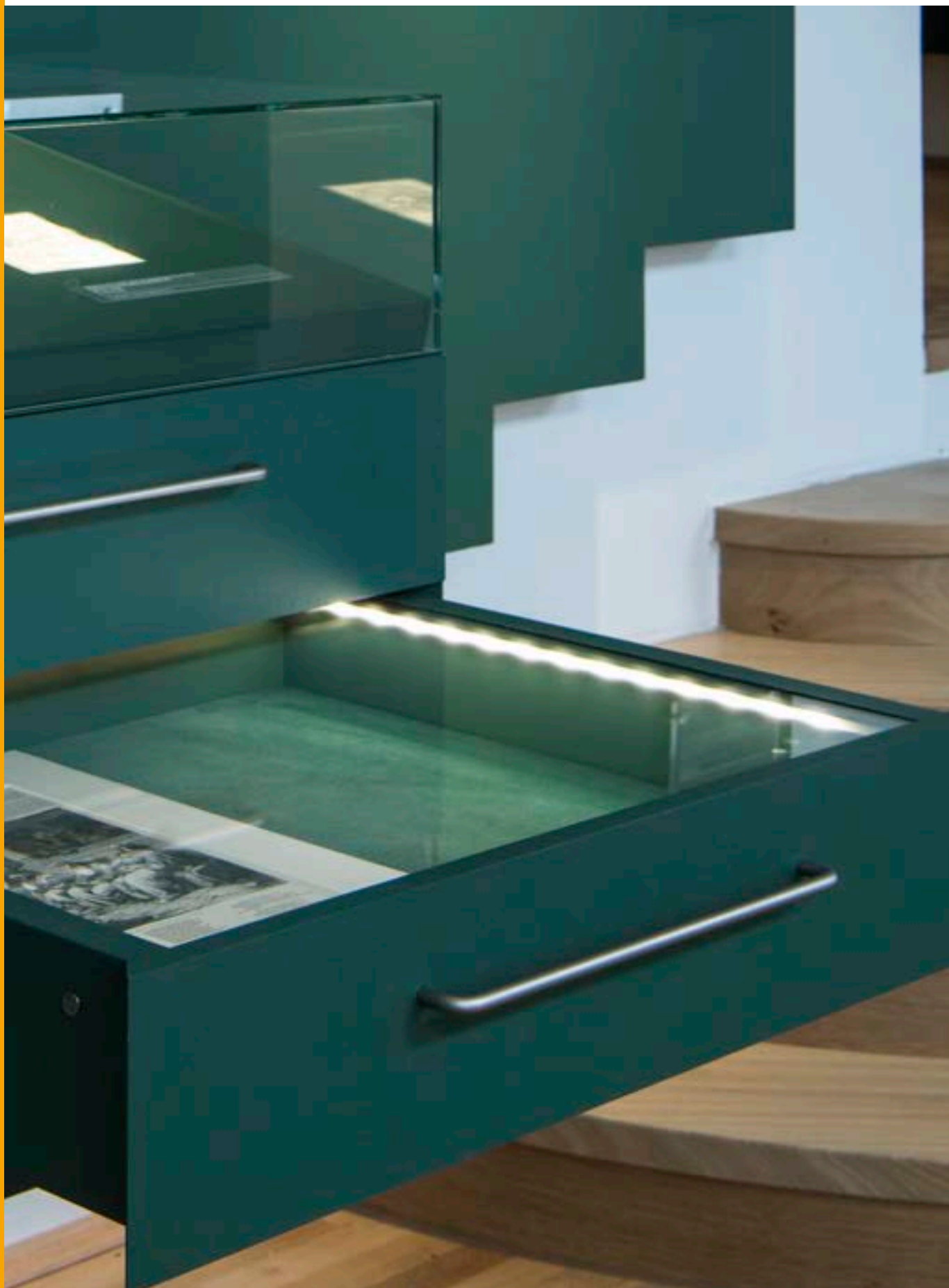

PROFILE STRIP SELECT, 24V



120 LEDs per m
 Width / height: 0.8/0.2 cm
 LED spacing: 0.8 cm
 Can be separated every 5 cm
 Minimum bend radius: 3.8 cm

5 m, CRI>80

Colour temperature	Luminous flu (lm)	Output (W)	Colour rend. index (CRI)	Colour consistency	L (cm)	Energy efficien index	Item no.
2700K	4000	40	>80	3SDCM	500	A+	552692
3000K							552693
4000K							552694

To obtain consistent light output from a length of 2.5 m, we recommend supplying power the strips at both ends. For lengths in excess of 5 m, a new power supply must be added.



i To ensure that heat is dissipated, the LED strips must be glued into an aluminium profile. There is adhesive tape on the rear of the LED strips.

FLEXLED ROLL SELECT

24V



FLEXLED ROLL SELECT, 24V



60 LEDs per m
 Width / height: 0.8/0.1 cm
 LED spacing: 1.7 cm
 Can be separated every 10 cm
 Minimum bend radius: 1.3 cm

5 m, CRI>80

Colour temperature	Luminous flu (lm)	Output (W)	Colour rend. index (CRI)	Colour consistency	L (cm)	Energy efficien index	Item no.
2700K	2500	25	>80	3SDCM	500	A+	552422
3000K	2550						552423
5000K	2850						552425

To obtain constant light output over long lengths, the strips should be powered on both ends.
 For lengths in excess of 5 m, a new power supply must be added.

FLEXLED ROLL SELECT, 24V ACCESSORIES

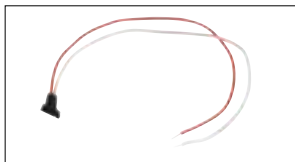

Power supply, 30 cm cable



Direct connector



Connector

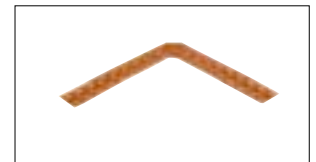

90° solder corners

Variant	Max. perm. current	Material	L (cm)	W (cm)	H (cm)	Item no.
■ Power supply, 1 piece	2A	Plastic	50	1.5	0.5	550412
■ Direct connector, 2 pieces	2A	Plastic	1.4	1.4	0.4	550415
□ Connector, 1 piece	10A	Plastic PC	2.7	1.4	1.1	550560
■ 90° solder corners, 1 piece	2A	-	5	0.8	-	550571

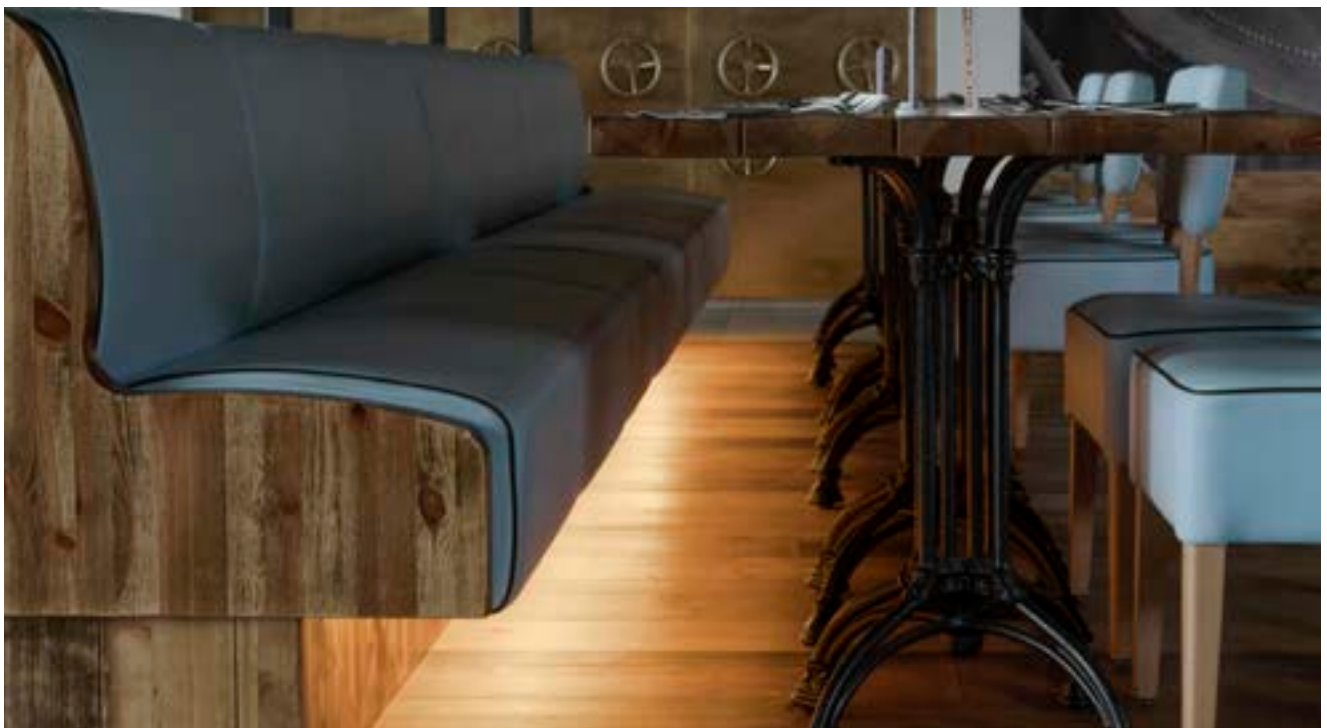

i To ensure that heat is dissipated, the LED strips must be glued into an aluminium profile
 There is adhesive tape on the rear of the LED strips.

LED STRIP

24V



LED STRIP, 24V



60 LEDs per m
 Width / height: 1/0.2 cm
 LED spacing: 1.7 cm
 Can be separated every 10 cm
 Minimum bend radius: 1.3 cm

3 m, CRI>80

Colour temperature	Luminous flu (lm)	Output (W)	Colour rend. index (CRI)	Colour consistency	L (cm)	Energy efficien index	Item no.
2700K	2775	30	>80	3SDCM	300	A+	552442
3000K	3000						552443
4000K	3600						552445

To obtain constant light output over long lengths, the strips should be powered on both ends.
 For lengths in excess of 3 m, a new power supply must be added.

LED STRIP ACCESSORIES

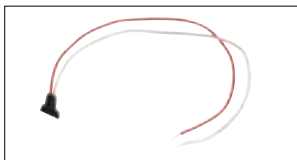

Power supply, 30 cm cable



Direct connector



Connector

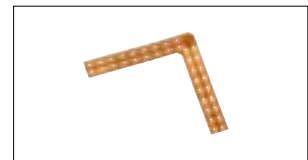

90° solder corners

Variant	Max. perm. current	Material	L (cm)	W (cm)	H (cm)	Item no.
■ Power supply, 1 piece	2A	Plastic	30	–	–	550413
■ Direct connector, 2 pieces	2A	Plastic	1.4	1.6	0.4	550416
□ Connector, 1 piece	10A	Plastic PC	2.7	1.4	1.1	550560
■ 90° solder corners, 1 piece	2A	–	5	0.8	–	550570



To ensure that heat is dissipated, the LED strips must be glued into an aluminium profile
 There is adhesive tape on the rear of the LED strips.

FLEXLED ROLL

24V



FLEXLED ROLL, 24V

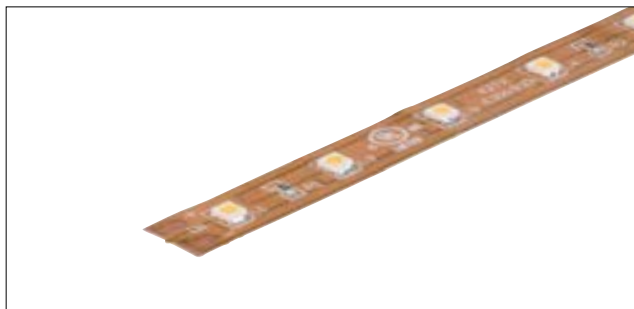

60 LEDs per m
 Width / height: 1/0.2 cm
 LED spacing: 1.7 cm
 Can be separated every 10 cm
 Minimum bend radius: 1.3 cm

5 m, CRI>80

Colour temperature	Luminous flu (lm)	Output (W)	Colour rend. index (CRI)	Colour consistency	L (cm)	Energy efficien index	Item no.
2700K	1850	20	>80	6SDCM	500	A+	552120
3000K							552122
5000K							552121

To obtain constant light output over long lengths, the strips should be powered on both ends.
 For lengths in excess of 5 m, a new power supply must be added.

FLEXLED ROLL, 24V ACCESSORIES

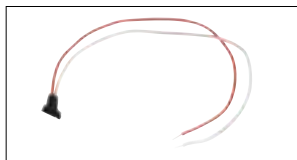

Power supply, 30 cm cable



Direct connector



Connector

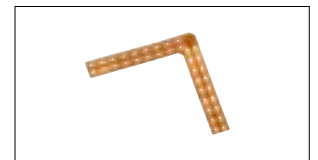

90° solder corners

Variant	Max. perm. current	Material	L (cm)	W (cm)	H (cm)	Item no.
■ Power supply, 1 piece	2A	Plastic	30	–	–	550413
■ Direct connector, 2 pieces	2A	Plastic	1.4	1.6	0.4	550416
□ Connector, 1 piece	10A	Plastic PC	2.7	1.4	1.1	550560
■ 90° solder corners, 1 piece	2A	–	5	0.8	–	550570



To ensure that heat is dissipated, the LED strips must be glued into an aluminium profile
 There is adhesive tape on the rear of the LED strips.

FLEXLED STRIP

24V



FLEXLED STRIP, 24V



120 LEDs per m
Width / height: 1/0.12 cm
LED spacing: 0.84 cm
Can be separated every 5 cm
Minimum bend radius: 6 cm

10 m, CRI>80

Colour temperature	Luminous flu (lm)	Output (W)	Colour rend. index (CRI)	Colour consistency	L (cm)	Energy efficien index	Item no.
2200K	10500	121.5	>80	3SDCM	1000	A	1001972
2700K	12000					A+	1002026
3000K	12000					1002027	
4000K	12800					1002028	

To obtain constant light output over long lengths, the strips should be powered on both ends.



To ensure that heat is dissipated, the LED strips must be glued into an aluminium profile
There is adhesive tape on the rear of the LED strips.



FLEXLED STRIP, 24V



48 LEDs per m
Width / height: 1/0.12 cm
LED spacing: 1.7 cm
Can be separated every 10 cm
Minimum bend radius: 3 cm

80 m, CRI>90

Colour temperature	Luminous flu (lm)	Output (W)	Colour rend. index (CRI)	Colour consistency	L (cm)	Energy efficien index	Item no.
2200K	17600	211.2	>90	4SDCM	8000	A	1002996
2700K	19200					A+	1002997
3000K	19200					1002998	
4000K	21600					1002999	

To obtain consistent light output with a length of 80 m, we recommend providing a power supply to the strips at both ends. With a one-sided power supply, a new power supply must be provided from a length of 40 m.



Extra-long strip **80 m**



To ensure that heat is dissipated, the LED strips must be glued into an aluminium profile. There is adhesive tape on the rear of the LED strips.

FLEXSTRIP LED HIGH LUMEN

24V

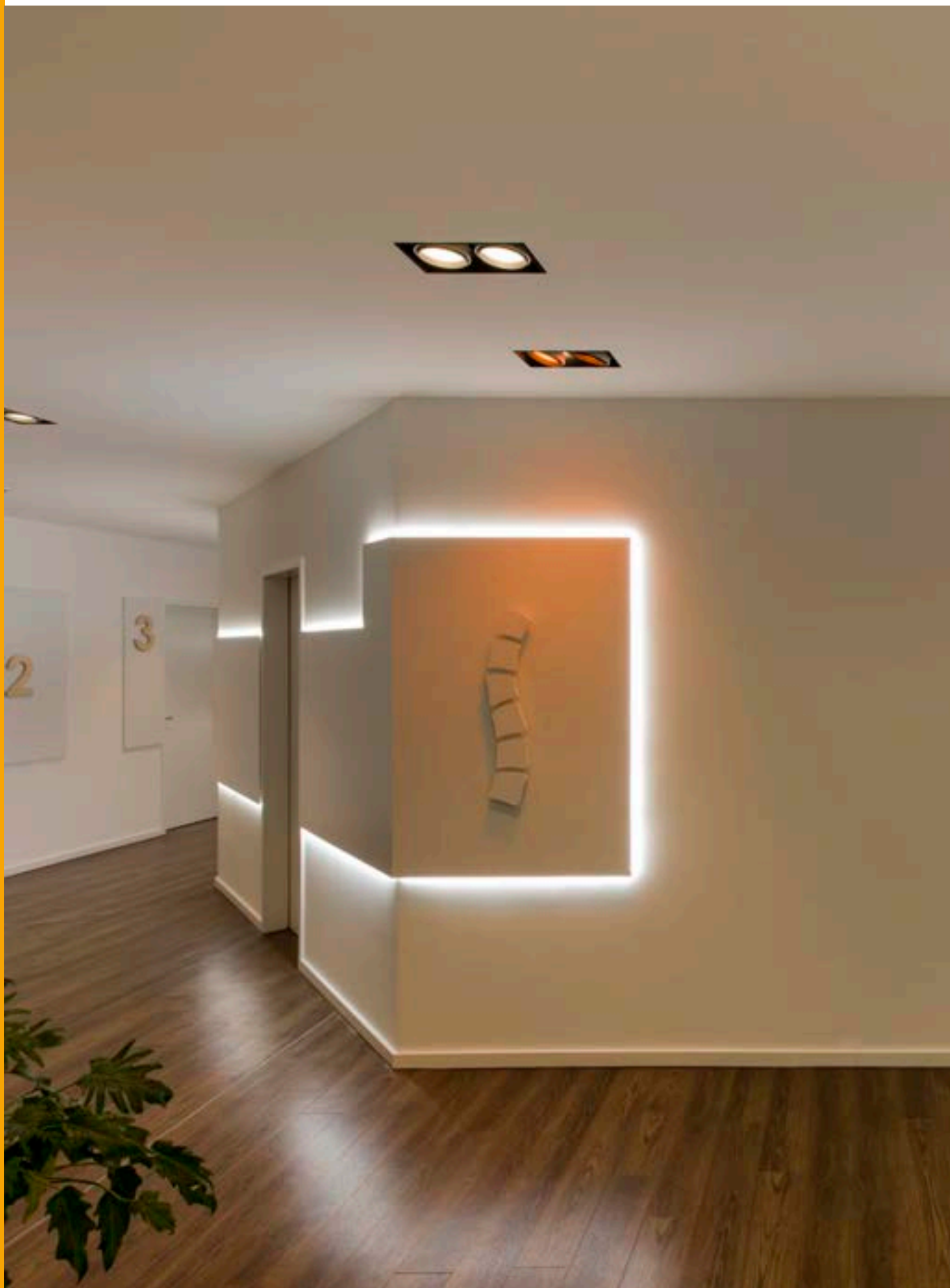

FLEXSTRIP LED HIGH LUMEN, 24V



120 LEDs per m
 Width / height: 1/0.1 cm
 LED spacing: 0.8 cm
 Can be separated every 5 cm
 Minimum bend radius: 1.3 cm

2 m, CRI>80

Colour temperature	Luminous flu (lm)	Output (W)	Colour rend. index (CRI)	Colour consistency	L (cm)	Energy efficien index	Item no.
2700K	3800	42	>80	3SDCM	200	A	552482
3000K	3880						552483
5000K	4300						552485

To obtain constant light output over long lengths, the strips should be powered on both ends.

FLEXSTRIP LED HIGH LUMEN, 24V ACCESSORIES

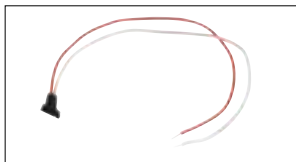

Power supply, 30 cm cable



Direct connector



Connector

Variant	Max. perm. current	Material	L (cm)	W (cm)	H (cm)	Item no.
■ Power supply, 1 piece	2A	Plastic	30	-	-	550413
■ Direct connector, 2 pieces	2A	Plastic	1.4	1.6	0.4	550416
□ Connector, 1 piece	10A	Plastic PC	2.7	1.4	1.1	550560



To ensure that heat is dissipated, the LED strips must be glued into an aluminium profile
 There is adhesive tape on the rear of the LED strips.

FLEXLED ROLL

24V

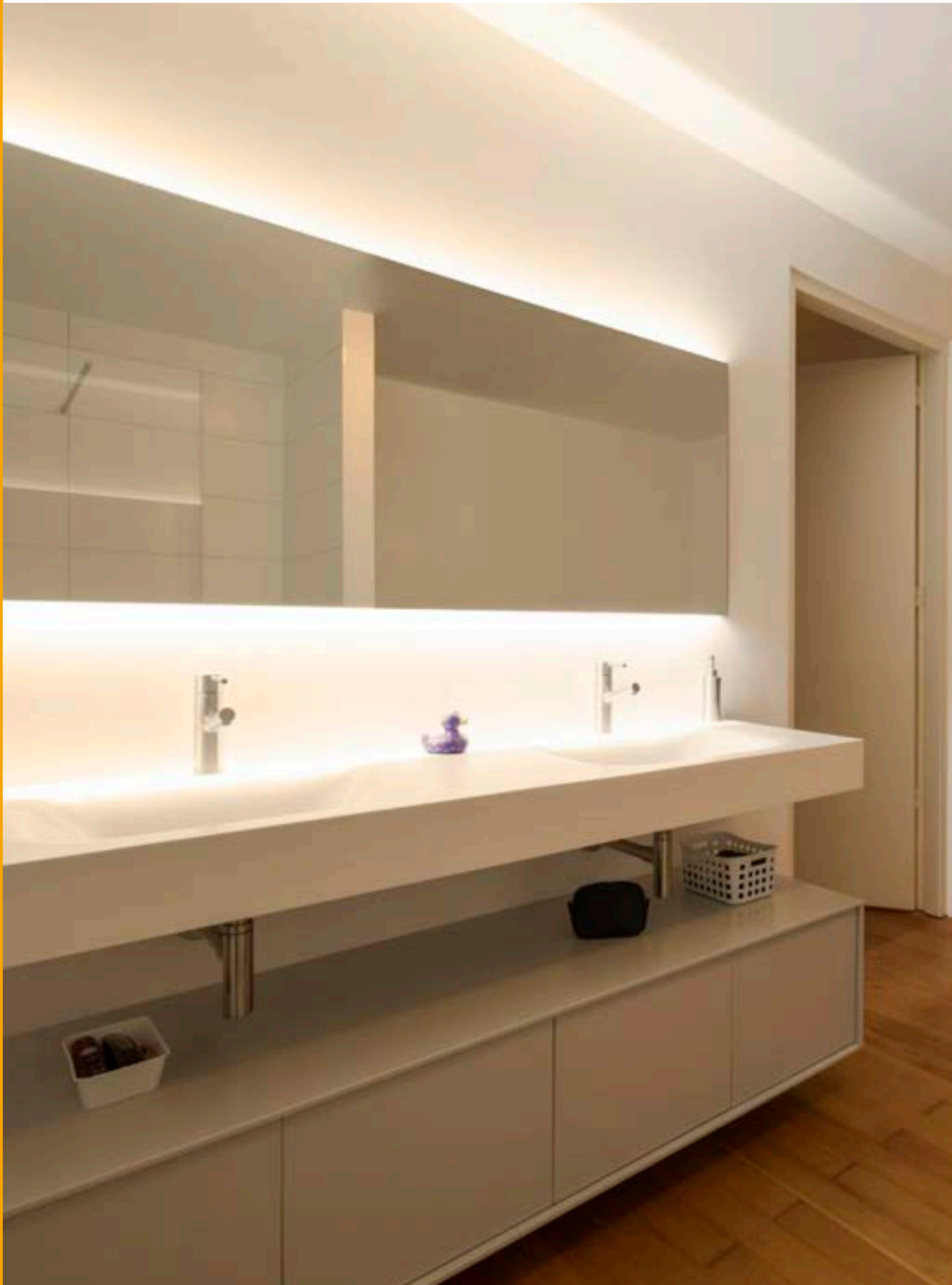



FLEXLED ROLL, 24V



60 LEDs per m
 Width / height: 0.6/0.1 cm
 LED spacing: 1.6 cm
 Can be separated every 10 cm

5 m, CRI>80

Colour temperature	Luminous flu (lm)	Output (W)	Colour rend. index (CRI)	Colour consistency	L (cm)	Energy efficien index	Item no.
2700K	1925	20	>80	3SDCM	500	A+	552522
3000K	1975						552523
5000K	2350						552525

To obtain constant light output over long lengths, the strips should be powered on both ends.

FLEXLED ROLL 24V ACCESSORIES

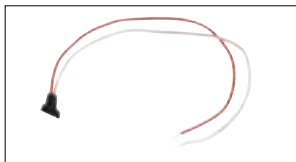

Power supply, 30 cm cable



Direct connector



Connector

Variant	Max. perm. current	Material	L (cm)	W (cm)	H (cm)	Item no.
<input type="checkbox"/> Power supply, 1 piece	2A	Plastic	50	-	-	550412
<input checked="" type="checkbox"/> Direct connector, 2 pieces	2A	Plastic	1.4	1.4	0.4	550415
<input type="checkbox"/> Connector, 1 piece	10A	Plastic PC	2.7	1.4	1.1	550560



i To ensure that heat is dissipated, the LED strips must be glued into an aluminium profile
 There is adhesive tape on the rear of the LED strips.

KELVIN CONTROL STRIP

24V



KELVIN CONTROL STRIP, 24V



240 LEDs per m
Width / height: 1/0.2 cm
Can be separated every 5 cm
Minimum bend radius: 3.8 cm
For the Kelvin Control System
Light colour adjustable from 2700K-6500K

3 m, CRI>80

Colour temperature	Luminous flu (lm)	Output (W)	Colour rend. index (CRI)	Colour consistency	L (cm)	Energy efficien index	Item no.
2700K - 6500K	1881 - 3921	18 - 36	>80	3SDCM	300	A+	552863
2700K - 6500K	3522 - 7230	37.5 - 75				A	552883

To obtain consistent light output from a length of 1.5 m, we recommend supplying power the strips at both ends.
 For lengths in excess of 3 m, a new power supply must be added.

KELVIN CONTROL STRIP, 24V ACCESSORIES



KELVIN CONTROL master controller with remote control



KELVIN CONTROL slave controller



KELVIN CONTROL remote control

Variant	Material	L (cm)	W (cm)	H (cm)	Item no.
<input type="checkbox"/> KELVIN CONTROL master controller, 1 piece	Plastic PC	8.6	2.1	0.9	470681
<input type="checkbox"/> KELVIN CONTROL slave controller, 1 piece	Plastic PC	8.6	2.1	0.9	470682
<input type="checkbox"/> KELVIN CONTROL remote control, 1 piece	Plastic PC	11.4	5.6	2.4	470683



i To ensure that heat is dissipated, the LED strips must be glued into an aluminium profile
 There is adhesive tape on the rear of the LED strips.

FLEXSTRIP LED RGB

24V

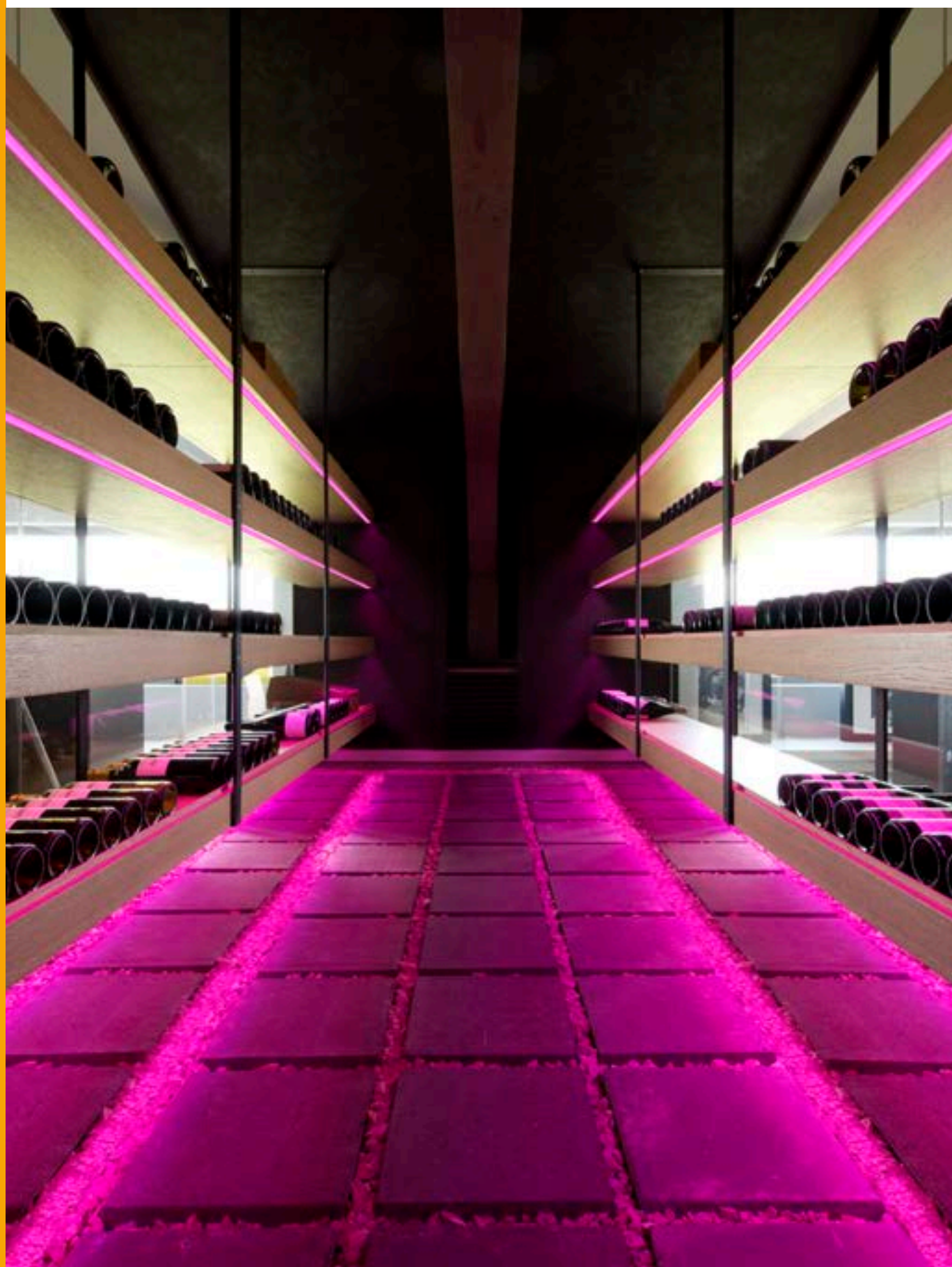

FLEXSTRIP LED RGB, 24V



60 LEDs per m
 Width / height: 1/0.2 cm
 LED spacing: 1.6 cm
 Can be separated every 10 cm
 Minimum bend radius: 1.3 cm

5 m

Colour temperature	Output (W)	L (cm)	Item no.
RGB	75	500	552649

For lengths in excess of 1.5 m, a power supply must be provided at both ends. For lengths in excess of 3 m, a new power supply must be added.

FLEXSTRIP LED RGB, 24V ACCESSORIES



Power supply, 50 cm cable



Direct connector



Flexible connector, 10 cm cable

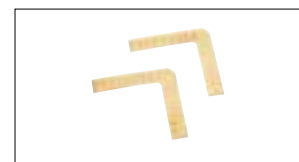

Solder corners 90°

Variant	Max. perm. current	Material	L (cm)	W (cm)	H (cm)	Item no.
<input type="checkbox"/> Power supply, 1 piece	2.1A	Plastic	30	1.5	0.5	552650
<input type="checkbox"/> Direct connector, 1 piece	2.1A	Plastic	1.6	1.4	0.5	552651
<input type="checkbox"/> Flexible connector, 1 piece	2.1A	Plastic	1.7	1.5	0.5	552652
<input checked="" type="checkbox"/> Soldering corners 90°, 1 piece	2A		5.2	5.2	0.01	552653



i To ensure that heat is dissipated, the LED strips must be glued into an aluminium profile. There is adhesive tape on the rear of the LED strips.

FLEXLED ROLL MULTICOLOUR RGBW, 24V



FLEXLED ROLL MULTICOLOUR RGBW, 24V



60 LEDs per m
Width / height: 1.2/0.2 cm
LED spacing: 1.7 cm
Can be separated every 10 cm
Minimum bend radius: 1.3 cm

3 m, CRI>80

Colour temperature	Output (W)	Colour rend. index (CRI)	Colour consistency	L (cm)	Energy efficien index	Item no.
RGBW	48	>80	6SDCM	300	A	552453

To obtain consistent light output from a length of 1.5 m, we recommend supplying power the strips at both ends. For lengths in excess of 3 m, a new power supply must be added.

FLEXLED ROLL MULTICOLOUR RGBW 24V ACCESSORIES

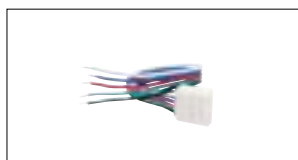

Power supply, 50 cm cable



Direct connector



Connector, 10 cm cable

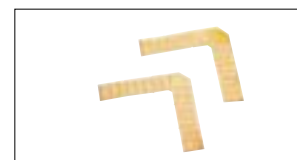

Solder corners 90°

Variant	Max. perm. current	Material	L (cm)	W (cm)	H (cm)	Item no.
<input type="checkbox"/> Power supply, 1 piece	2A	Plastic	50	–	–	552460
<input type="checkbox"/> Direct connector, 1 piece	2A	Plastic	1.6	1.6	0.5	552461
<input type="checkbox"/> Connector, 1 piece	2A	–	10	–	–	552462
<input checked="" type="checkbox"/> Soldering corners 90°, 2 pieces	2A	–	5.2	5.2	0.01	552463



To ensure that heat is dissipated, the LED strips must be glued into an aluminium profile. There is adhesive tape on the rear of the LED strips.

FLEXLED ROLL RGB

24V



FLEXLED ROLL RGB, 24V



120 LEDs per m
 Width / height: 2/0.15 cm
 LED spacing: 0.8 cm
 Can be separated every 5 cm
 Minimum bend radius: 3.8 cm
 IP protection class: IP20

3 m

Colour temperature	Output (W)	L (cm)	Item no.
RGB	72	300	1001971

To obtain consistent light output from a length of 1.5 m, we recommend supplying power the strips at both ends. For lengths in excess of 3 m, a new power supply must be added.



To ensure that heat is dissipated, the LED strips must be glued into an aluminium profile. There is adhesive tape on the rear of the LED strips.

FLEX ROLL

24V



FLEX ROLL, 24V



60 LEDs per m
Width / height: 1.3/0.5 cm
LED spacing: 1.7 cm
Can be separated every 10 cm
Minimum bend radius: 3.75 cm
IP protection class: IP55

5 m, CRI>80

Colour temperature	Luminous flu (lm)	Output (W)	Colour rend. index (CRI)	Colour consistency	L (cm)	Energy efficien index	Item no.
3000K	1500	25	>80	6SDCM	500	A	552273

To obtain consistent light output over long lengths, we recommend providing a power supply to the strips at both ends. For lengths in excess of 5 m, a new power supply must be added.



To ensure that heat is dissipated, the LED strips must be glued into an aluminium profile. There is adhesive tape on the rear of the LED strips.

DELFD

24V



DELFD, 24V

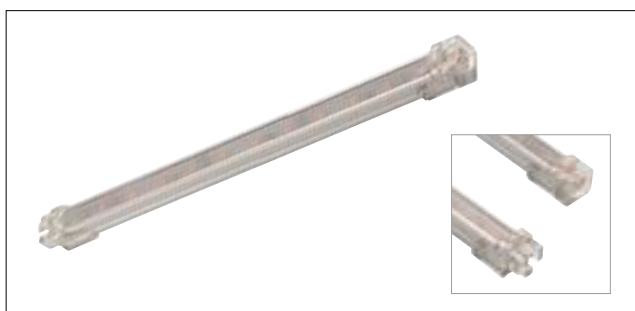

24V DC
Width / height: 1.5/1.4 cm
Material: Aluminium / Plastic
Protection class: III
Half beam angle: 110°

Plug-in system, can be lengthened without tools up to 3 m

aluminium

Colour temperature	Luminous flu (lm)	Output (W)	Colour rend. index (CRI)	L (cm)	Weight (kg)	Energy efficien index	Item no.
3000K	105	1.5	>80	10.5	0.02	A-A++	631501
	190	2.6		20.5	0.04		631502
	500	6.3		50.5	0.08		631505
	1000	13.4		100.5	0.15		631510
	1100	15.7		120.5	0.19		631512

DELFD, 24V ACCESSORIES



Power supply, 1.5 m cable



Connector, 12 cm cable



Mounting clips



45° mounting clips

Variant	Max. perm. current	Material	L (cm)	W (cm)	H (cm)	Item no.
Power supply, 1 piece	2A	Plastic	150	-	-	631520
Connector, 1 piece	2A	Plastic	15	-	-	631521
Mounting clips, 10 pieces	-	Stainless Steel	1	1.5	0.9	631522
Mounting clips 45°, 10 pieces	-	Stainless Steel	1	1.5	1.7	631523

BATTEN LED

220-240V ~50/60HZ





BATTEN LED 220-240V ~50/60Hz



220-240V ~50/60Hz 67V DC
Width / height: 2.5/3.5cm
Material: Plastic PC
Protection class: II
Ambient temperature -20°C to 40°C
Half beam angle 155°

Can be lengthened without tools

matt white

Colour temperature	Luminous flu (lm)	Output (W)	Colour rend. index (CRI)	L (cm)	Weight (kg)	Energy efficien index	Item no.
3000K	735	8.1	>80	57.5	0.17	A-A++	631313
	1065	12.4		87.5	0.23		631315
	1470	16.5		117.5	0.29		631317
4000K	855	8.1	>80	57.5	0.17	A-A++	631323
	1235	12.4		87.5	0.23		631325
	1710	16.5		117.5	0.28		631327

BATTEN LED ACCESSORY 220-240V ~50/60Hz

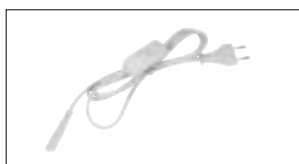

Power supply cable with switch, 1.5 m cable



Power supply cable, 1.5 m cable

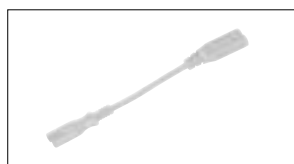

Connecting cable, 15 cm cable

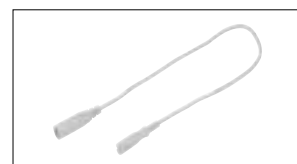

Connecting cable, 15 cm cable



Mounting clips 45°



Connector

Variant	Max. perm. current	Material	L (cm)	W (cm)	H (cm)	Item no.
<input type="checkbox"/> Power supply cable with switch, 1 piece	2A	Plastic	150	-	-	631300
<input type="checkbox"/> Power supply cable, 1 piece	2A	Plastic	150	-	-	631301
<input type="checkbox"/> Connecting cable, 1 piece	2A	Plastic	15	-	-	631302
<input type="checkbox"/> Connecting cable, 1 piece	2A	Plastic	50	-	-	631303
<input checked="" type="checkbox"/> Mounting clips 45°, 3 pieces	-	Steel	2.5	1.3	1.2	631304
<input type="checkbox"/> Connector, 1 piece	2A	Plastic	2.2	2	1.1	631305





SIMPLE. COMPATIBLE. SMART.

The SLV VALETO® SMART LIGHT SYSTEM is the intelligent light solution for the home and for hotel, restaurant and shop concepts. Thanks to the ZigBee® 3.0 standard, you can enjoy compatibility with many of the most popular Smart Home systems:

Philips Hue | **Osram Smart+** | **Amazon Alexa**

Control is very simple via remote control, app or voice command using Amazon Alexa. And of course, SLV VALETO® SMART LIGHT SYSTEM can also be integrated into existing electrical installations.



Photo Stock: © Mathias Wegert, © blackzheap



Scalable:

Installations with up to 200 luminaires can be realised using the SLV VALETO® Gateway.



Integrable:

Thanks to the ZigBee® 3.0 standard, SLV VALETO® is compatible with products and systems from other manufacturers.



Controllable:

Very easy to control using an app, remote control or voice assistant systems.



Long range:

SLV VALETO® products can also be controlled over long distances by setting up your own mesh network.*



Secure:

The gateway only stores your information locally, and does not store anything in the cloud.

*Excludes battery-operated devices.

SIMPLE.

The ideal entry point into smart light control: Simply connect our SLV VALETO® remote controls (e.g.: 1002994) with the SLV VALETO® lamps (e.g.: 1001917) and see how simple smart can be.



Remote control
Item no. 1002994



Lamp
Item no. 1001917

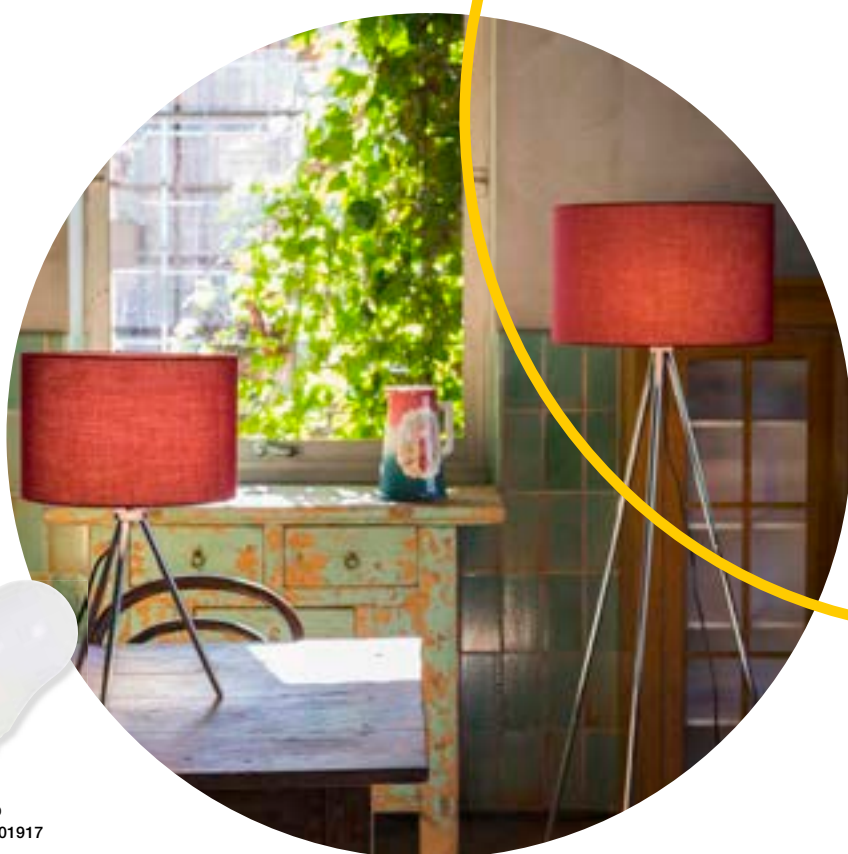

ADVANCE.

Do you want a little more?

With our SLV VALETO® SMART LIGHT SYSTEM the choice is yours: Control your light at home with our SLV VALETO® remote control (1002994), or an app on your Smartphone via our SLV VALETO® Gateway (1002411).

Thanks to the latest ZigBee standard (ZigBee® 3.0) there are no limits to your smart light control.



12/24V strip, control module
Item no. 1001859



Lamp



Remote control
Item no. 1002994



Gateway
Item no. 1002411



PROFESSIONAL.

Big plans?

More than 150 smart products can be integrated in a smart light control system with our SLV VALETO® SMART LIGHT SYSTEM. You can control your devices from anywhere and any time and set the scene for your project in a perfect way with ease.



12/24V strip, control module
Item no. 1001859



Lamp



Phase cut dimmer
Item no. 1002995



Gateway
Item no. 1002411

MORE COMFORT AND SAFETY

The ideal solution for wireless operation and monitoring of individual luminaires, from entire rooms to the complete living environment.

SLV VALETO® App

SLV VALETO® Gateway

Download on the App Store

GET IT ON Google Play



COMMUNICATION.

The heart of the Smart Light System is the SLV VALETO® gateway

SLV VALETO® Gateway

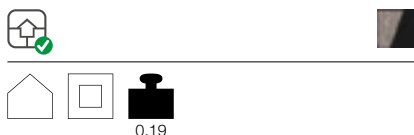

Product details

220-240V ~50/60Hz
 Operating voltage: 5V DC
 Output: <1W
 L: 10.6 cm W: 10.6 cm H: 2.6 cm
 Material: Aluminium / Plastic

Note

ZigBee® 3.0 certified product.
 A connection to a router via a LAN cable is required to control the gateway.

Scope of delivery

SLV VALETO® Gateway
 Connector power supply 5V, 1A
 Network cable, CAT6, 2m, black

Variant	Item no.
brushed metal / black	1002411



INTEGRABLE



GERMAN ENGINEERING



LONG RANGE



SECURE



LIGHTING SYSTEMS.

LED A60 E27, CCT



Product details

220-240V ~50/60Hz
 Output: 9W
 Ø: 6 cm H: 12 cm

Note

Can be remote controlled and dimmed using SLV VALETO® CCT/RGBW remote control [1002994] or Gateway [1002411]

Lamp current	0.052A
Output	9W
Energy consump./1000h	9kWh
Colour temperature	2700K-6500K
Luminous flu	806lm
Colour rendering index	>80

Variant	Item no.
	1001916

LED A60 E27, RGBW



Product details

220-240V ~50/60Hz
 Output: 9.5W
 Ø: 6 cm H: 12 cm

Note

Can be remote controlled and dimmed using SLV VALETO® CCT/RGBW remote control [1002994] or Gateway [1002411]

Lamp current	0.054A
Output	9.5W
Energy consump./1000h	10kWh
Colour temperature	RGBW
Luminous flu	806lm
Colour rendering index	>80

Variant	Item no.
	1001917

LED QPAR51 GU10, CCT

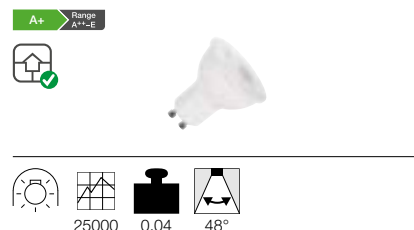

Product details

220-240V ~50/60Hz
 Output: 5.1W
 Ø: 5 cm H: 5.4 cm

Note

Can be remote controlled and dimmed using SLV VALETO® CCT/RGBW remote control [1002994] or Gateway [1002411]

Lamp current	0.027A
Output	5.1W
Energy consump./1000h	6kWh
Colour temperature	2700-6500K
Luminous flu	350lm
Max. luminous intensity	500cd
Colour rendering index	>80

Variant	Item no.
	1001918



LIGHTING SYSTEMS.

LED QPAR51
GU10, RGBW

A+ Range A++-E

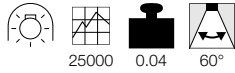

25000 0.04 60°

Product details

220-240V ~50/60Hz
Output: 5.6W
Ø: 5 cm H: 5.4 cm

Note

Can be remote controlled and dimmed using SLV VALETO® CCT/RGBW remote control [1002994] or Gateway [1002411]

Lamp current	0.041A
Output	5.6W
Energy consump./1000h	6kWh
Colour temperature	RGBW
Luminous flu	350lm
Colour rendering index	>80

Variant	Item no.
	1001919

LED QPAR111
GU10, CCT

A+ Range A++-E

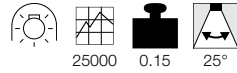

25000 0.15 25°

Product details

220-240V ~50/60Hz
Output: 9W
Ø: 11.1 cm H: 7 cm

Note

Can be remote controlled and dimmed using SLV VALETO® CCT/RGBW remote control [1002994] or Gateway [1002411]

Lamp current	0.048A
Output	9W
Energy consump./1000h	9kWh
Colour temperature	2700K-6500K
Luminous flu	800lm
Max. luminous intensity	3300cd
Colour rendering index	>80

Variant	Item no.
	1001920

LED QPAR111
GU10, CCT

A+ Range A++-E

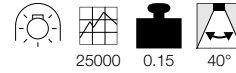

25000 0.15 40°

Product details

220-240V ~50/60Hz
Output: 9W
Ø: 11.1 cm H: 7 cm

Note

Can be remote controlled and dimmed using SLV VALETO® CCT/RGBW remote control [1002994] or Gateway [1002411]

Lamp current	0.048A
Output	9W
Energy consump./1000h	9kWh
Colour temperature	2700K-6500K
Luminous flu	800lm
Max. luminous intensity	1900cd
Colour rendering index	>80

Variant	Item no.
	1001921

LED QPAR111
GU10, RGBW

A+ Range A++-E



25000 0.15 25°

Product details

220-240V ~50/60Hz
Output: 9W
Ø: 11.1 cm H: 7 cm

Note

Can be remote controlled and dimmed using SLV VALETO® CCT/RGBW remote control [1002994] or Gateway [1002411]

Lamp current	0.048A
Output	9W
Energy consump./1000h	9kWh
Colour temperature	RGBW
Luminous flu	800lm
Colour rendering index	>80

Variant	Item no.
	1001922

LED QPAR111
GU10, RGBW

A+ Range A++-E

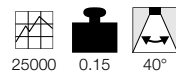

25000 0.15 40°

Product details

220-240V ~50/60Hz
Output: 9W
Ø: 11.1 cm H: 7 cm

Note

Can be remote controlled and dimmed using SLV VALETO® CCT/RGBW remote control [1002994] or Gateway [1002411]

Lamp current	0.048A
Output	9W
Energy consump./1000h	9kWh
Colour temperature	RGBW
Luminous flu	800lm
Colour rendering index	>80

Variant	Item no.
	1001923



CONTROL ELEMENTS:

SLV VALETO®
Remote control, CCT/RGBW

IP 20 0.068

Product details

Voltage: 3 V battery operation
L: 6.5 cm W: 6.5 cm H: 1.95 cm
Material: Plastic PC

Note

The SLV VALETO® CCT/RGBW remote control can control up to 20 ZigBee® devices in three groups. CCT and RGBW settings are possible.

Variant	Item no.
white	1002994

SLV VALETO®
Remote control

IP 20 0.06

Product details

Voltage: 3 V battery operation
L: 10 cm W: 5.7 cm H: 1.8 cm
Material: ABS / Plastic PC

Note

This remote control can only be used for dimming SLV VALETO® products and switching them on and off. C T and RGBW settings are not possible.

Variant	Item no.
white / anthracite	1002097



CONTROL DEVICES.

SLV VALETO®
Phase cut dimmer

IP 20 0.04

Product details

220-240V ~50/60Hz
Output: max. 200W
L: 4.5 cm W: 4.5 cm H: 2.2 cm
Material: Plastic PC

Note

Can be controlled using SLV VALETO® CCT/RGBW remote control [1002994] or Gateway [1002411]
Can be used as an independent dimmer without ZigBee®. Dimming procedure: trailing edge.
Dimmer for ohmic (high-voltage halogen lamp) and capacitive loads (LED driver). Suitable for any 60mm UP switch socket with a depth of 42mm. 200W LED load.

Variant	Item no.
black	1002995





CONTROL DEVICES.

SLV VALETO® 12/24V Strip control module | CCT

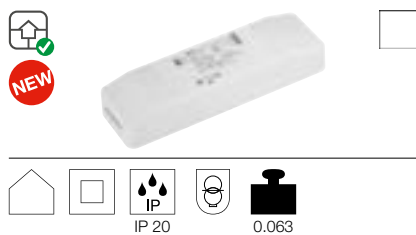

Product details

12V/24V DC
Output: max. 192W per channel
L: 13.4 cm W: 3.9 cm H: 2.4 cm
Material: Plastic

Note

Can be remote controlled and dimmed using SLV VALETO® CCT/RGBW remote control [1002994] or Gateway [1002411] The control module is suitable for controlling CCT LED strips.

SLV VALETO® 12/24V Strip control module | RGBW



Product details

12V/24V DC
Output: max. 96W per channel
L: 13.4 cm W: 3.9 cm H: 2.4 cm
Material: Plastic

Note

Can be remote controlled and dimmed using SLV VALETO® CCT/RGBW remote control [1002994] or Gateway [1002411] The control module is suitable for controlling RGBW LED strips.

SLV VALETO® 15W, LED driver



Product details

220-240V~50/60Hz
Output: 15W
L: 19 cm W: 6.1 cm H: 3 cm
Material: Plastic

Note

Can be remote controlled and dimmed using SLV VALETO® CCT/RGBW remote control [1002994] or Gateway [1002411]

Variant	Item no.
<input type="checkbox"/> white	1001859

Variant	Item no.
<input type="checkbox"/> white	1002892

Variant	Item no.
<input type="checkbox"/> white	1002082

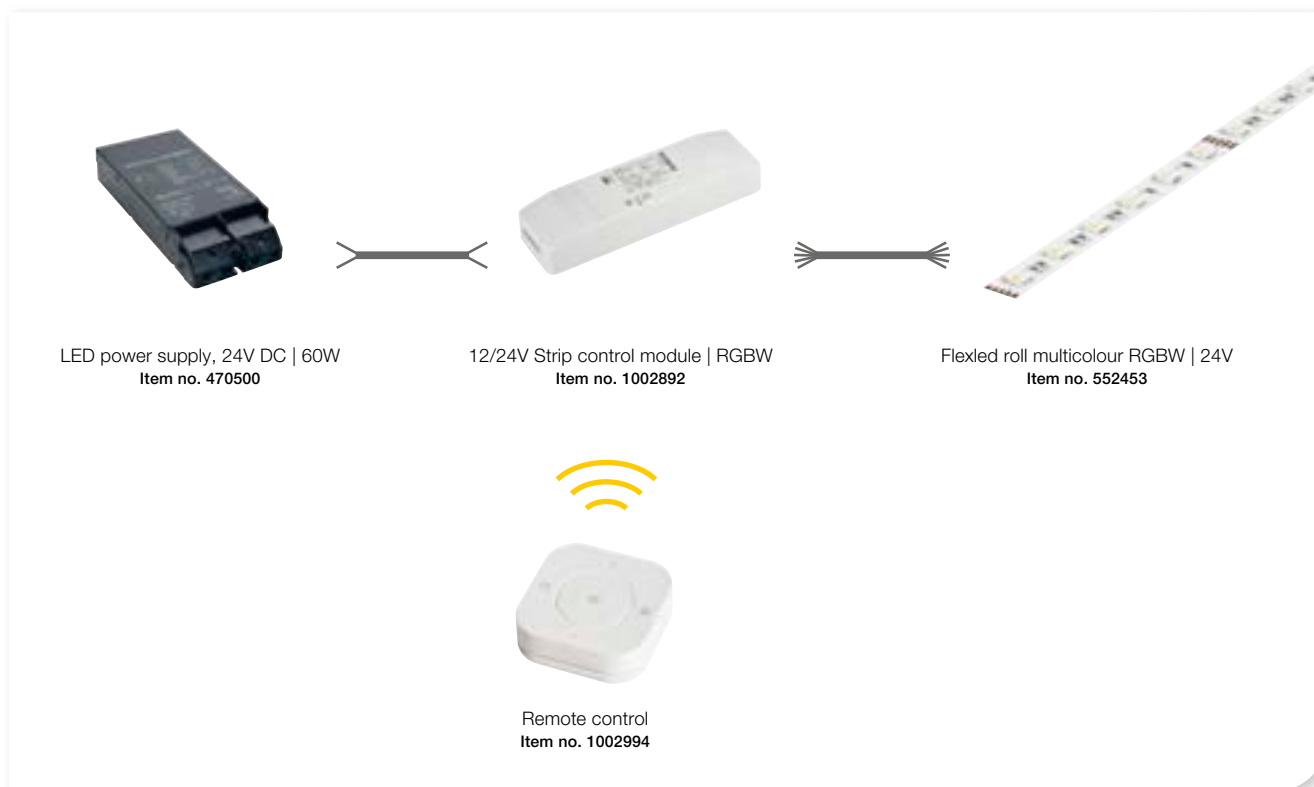

LED power supply, 24V DC | 60W
Item no. 470500

12/24V Strip control module | RGBW
Item no. 1002892

Flexed roll multicolour RGBW | 24V
Item no. 552453



Remote control
Item no. 1002994

MALANG
CW, SLV VALETO®

A-A++ Range A++-E

LED INSIDE

NEW

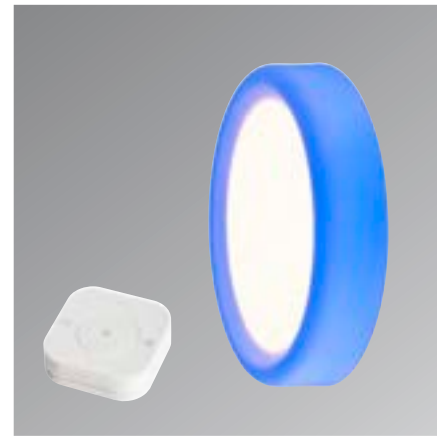

The decorative **RING** can be controlled separately. Create an atmospheric ambience by setting different light colours and dimming the light.

The **PANEL** can be controlled separately. You can set the colour temperature to 2700-6500K and dim the light.

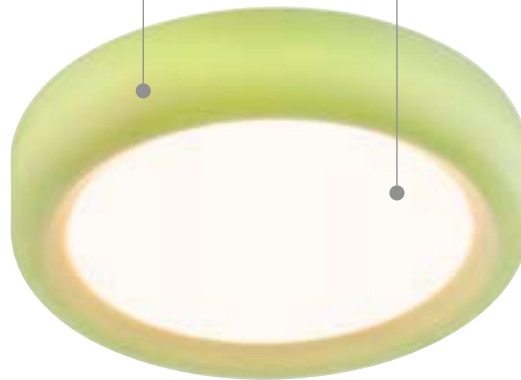

- Can be integrated in the SLV VALETO® system and other ZigBee® systems
- Panel can be controlled separately from warm white to cool white and dimmed
- The ring can be controlled separately in RGBW colours and dimmed

Product details

100-240V ~50/60Hz | 24V DC
Total consumption: 39W
Material: Aluminium / Polycarbonate (PC)

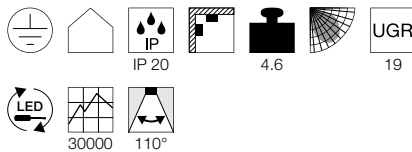

Dimensioned drawing

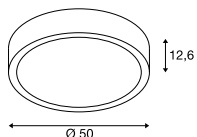

Note

Can be remote controlled and dimmed using SLV VALETO® CCT/RGBW remote control [1002994] or Gateway [1002411]

Recommended accessories

- Suspension set 1.5m
Item no. 135250
- Suspension set 1.5m
Item no. 135251
- Suspension set 1.5m
Item no. 135254
- Suspension set 5m
Item no. 1001950
- Suspension set 5m
Item no. 1001951
- Suspension set 5m
Item no. 1001952
- Remote control CCT/RGBW
Item no. 1002994

Variant	Item no.
Ring: 350lm RGB+W (3000K) CRI>80 Panel: 2100-2400lm 2700-6500K CRI>80 □ white	1002858

With our SLV VALETO® SMART LIGHT SYSTEM the choice is yours: Control your light at home with our SLV VALETO® remote control (1002994), or an app on your Smartphone via our SLV VALETO® Gateway (1002411).

Thanks to the latest ZigBee standard (ZigBee® 3.0) there are no limits to your smart light control.



Remote control
Item no. 1002994



Gateway
Item no. 1002411



SLV VALETO®
App

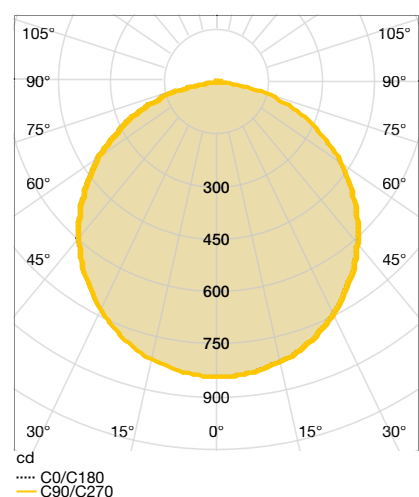
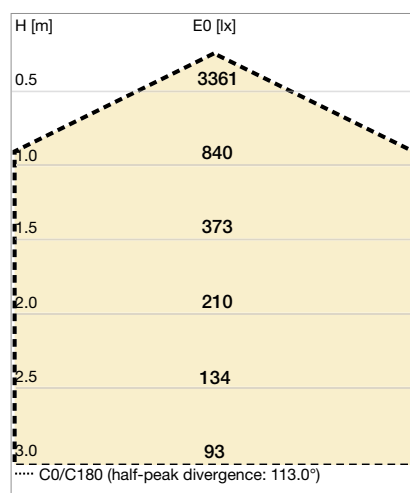



LIPSY®
CW, VALETO®

- Can be integrated into the VALETO® system

Product details

230V ~50/60Hz
Total consumption: 14,5W/17W/31,5W
Material: Polymethylacrylate (PMMA) / Steel

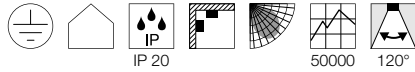

Note

Can be remote controlled and dimmed using SLV VALETO® CCT/RGBW remote control [1002994] or Gateway [1002411]

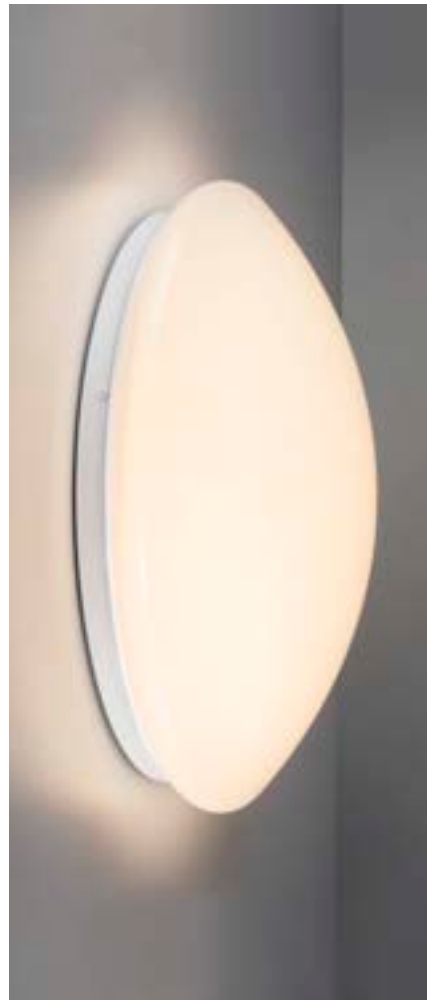

LIPSY® 30
CW, VALETO®



Dimensioned drawing

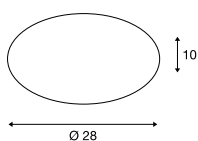

Variant	Item no.
1400lm 3000K CRI>80 0.4 kg □ white	1002132

LIPSY® 40
CW, VALETO®



Dimensioned drawing

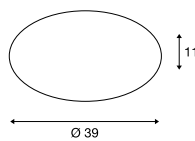

Variant	Item no.
1700lm 3000K CRI>80 0.77 kg □ white	1002133

LIPSY® 50
CW, VALETO®



Dimensioned drawing

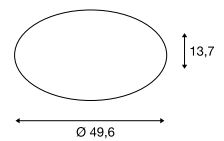

Variant	Item no.
2800lm 3000K CRI>80 1.36 kg □ white	1002134

SO SIMPLE, SO CLEVER!

OTHER SLV LIGHT CONTROLLERS



SLV COLOR CONTROL

Bring colour into your life! With the **SLV COLOR CONTROL** system. This allows you to switch luminaires on and off and to adjust their colour.

Dimming, colour control, grouping function

Accessories and components:

- App
- Remote control
- Wall control panel
- Master controller + remote control
- Slave controller
- Signal amplifier
- Bluetooth® adapter for app control
- Actuatable luminaires

All information from page 828 onwards

SLV KELVIN CONTROL

Nice and bright! With **SLV KELVIN CONTROL**, colour brightness and colour temperature can be controlled independently of each other and adapted to your desired lighting situation.

Dimming, colour temperature control, grouping function

Accessories and components:

- App
- Remote control
- Wall control panel
- Master controller + remote control
- Slave controller
- Signal amplifier
- Bluetooth® adapter for app control
- Actuatable luminaires

All information from page 832 onwards



SLV BLUETOOTH CONTROL

Sounds simply brilliant: With the **SLV BLUETOOTH CONTROL** system you can switch light installations on and off and control the brightness. Light installations can be grouped or controlled individually using the app.

Dimmability, grouping function

Accessories and components:

- App
- Dimming module

All information from page 835 onwards



SLV CONTROL BY TRUST

Wireless rather than clueless: **SLV CONTROL BY TRUST** is a self-contained, comprehensive Smart Home System for wireless control of luminaires and other technical devices.

Remote control (Internet), dimmability, timer function, grouping function

Accessories and components:

- App
- Remote control
- Internet Control Station
- Sensors
- Sockets
- Signal amplifier

All information from page 836 onwards



SLV COLOR CONTROL.

YOUR COMPLETE SYSTEM FOR COLOURED LIGHT CONTROL.

Using SLV COLOR CONTROL you can individually control the coloured light of your RGB/W devices indoors as you wish. Wireless technology using a wall-mounted control panel or with the optional Bluetooth® expansion to control via an App. The SLV COLOR CONTROL system uses the master/slave principle and can be expanded at any time. Your mood decides: If it should be red, yellow, blue or green light, or dimmable white background lighting.

SLV COLOR CONTROL gives you plenty of comfort. The system can control as many rooms as desired which can be divided up to three different colour zones and expanded within 15 m with many light sources. The colour control system can be combined with our SLV LIPSY luminaires or even RGB/W LED strips depending on the application and your taste.

YOUR COMPLETE SYSTEM IN EITHER 2 OR 3 STEPS:

TRANSMITTER



RECEIVER



PRODUCT



SLV COLOR CONTROL

Wall operating panel, recessed/surface mounted



0.18

Product details

100-240V ~50/60Hz
 Output up to: 2W
 Product dimensions: L: 8.6 cm W: 8.6 cm H: 5 cm
 Installation dimensions: Ø: 5.5 cm, D: 4 cm
 Material: Plastic PC / Glass

Note

Touch panel with glass-fronted panel for actuating slave controller [470672]. Range of touch panel can be increased with WLAN signal amplifier [470674]. Transmit frequency WLAN 2.4~2.48GHz; Range approx. 15m depending on the local conditions. Bluetooth® module [470675] which can be retrofitted for operation via Smartphone/tablet app. 34 pre-set programs, 10 speed levels, 30 pre-set static colours, 5 brightness levels for RGB, 10 brightness levels for white. Can be optionally controlled using a remote control [470677]. Suitable for installation in a switch box with a minimum depth of 40 mm. Accessories / included: Surface-mounted housing [incl.]

Output up to	2W
Min. ambient temp.	-30°C
Max. ambient temp.	50°C

Variant	Item no.
<input type="checkbox"/> white	470670

SLV COLOR CONTROL

Remote control



0.06

Product details

Prim. voltage: Battery operated
 Product dimensions: L: 11.4 cm W: 5.6 cm H: 2.4 cm
 Material: Plastic PC

Note

Remote control as optional operation for the RGBW touch controller wall panel [470670]; Replacement remote control for master controller [470671]; Transmit frequency: 433.92MHz.
 Accessories / included: 2 batteries AAA 1.5V [excl.]

Min. ambient temp.	-30°C
Max. ambient temp.	50°C

Variant	Item no.
<input type="checkbox"/> white	470677

SLV COLOR CONTROL

Master controller with remote control



0.08

Product details

12V DC / 24V DC
 Output up to: 72/144W
 Product dimensions: L 8.6 cm W: 2.1 cm H:0.9 cm
 Material: Plastic PC

Note

Master Controller with remote control for connecting LED strips 12-24VDC, can be extended with the Slave Controller [470672]. Range of the controller can be increased using WLAN Sync. Signal amplifier [470674]; transmit frequency WLAN 2.4~2.48GHz; Range approx. 15 m depending on the local conditions. Range can be increased using the Repeater [470674]. 34 fixed programs, 30 fixed static colours; 10 speed settings, 5 RGB dimmer settings, 10 dimmer settings for white. Reverse polarity protection, overload; Short-circuit and overheating. Accessories / included: Remote control incl. [L/W/H: 11.4/5.6/2.4], power supply cable length: 12 cm, 2 batteries AAA 1.5V [excl.]

Prim. voltage:	12V DC / 24V DC
Voltage sec.	12V DC / 24V DC
Output up to	72 / 144W
Wattage per output	18 / 36W
Min. ambient temp.	-30°C
Max. ambient temp.	50°C
Fault protection	Shut-off temperature
No. of fuses (sec)	3
Max. no. slaves	unlimited

Variant	Item no.
<input type="checkbox"/> white	470671

SLV COLOR CONTROL

Slave controller

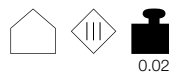

0.02

Product details

12V DC / 24V DC
 Output up to: 72/144W
 Product dimensions: L 8.6 cm W: 2.1 cm H:0.9 cm
 Material: Plastic PC

Note

Slave controller for extending the master controller [470670, 470671]; Receive frequency WLAN 2.4~2.48GHz; Reverse polarity protection, overload; Short-circuit and overheating.

Prim. voltage:	12V DC / 24V DC
Voltage sec.	12V DC / 24V DC
Output up to	72 / 144W
Wattage per output	18 / 36W
Min. ambient temp.	-30°C
Max. ambient temp.	50°C
Fault protection	Shut-off temperature
No. of fuses (sec)	3

Variant	Item no.
<input type="checkbox"/> white	470672

FLEXLED ROLL MULTICOLOUR RGBW, 24V



60 LEDs per m
Width / height: 1.2/0.2 cm
LED spacing: 1.7 cm
Can be separated every 10 cm
Minimum bend radius: 1.3 cm

3 m, CRI>80

Colour temperature	Output (W)	Colour rend. index (CRI)	Colour consistency	L (cm)	Energy efficien index	Item no.
RGBW	48	>80	6SDCM	300	A	552453

To obtain consistent light output from a length of 1.5 m, we recommend supplying power to the strips at both ends.
 For lengths in excess of 3 m, a new power supply must be added.

FLEXLED ROLL MULTICOLOUR RGBW, 24V ACCESSORIES



LED power supply, 20W



LED power supply, 60W

Variant	Max. perm. current	Material	L (cm)	W (cm)	H (cm)	Item no.
<input type="checkbox"/> LED power supply	24V, 20W	Plastic PC	16.7	3.8	3	470542
<input type="checkbox"/> LED power supply	24V, 60W	Plastic PC	17.5	7.8	3.5	470506

SIGNAL AMPLIFIER

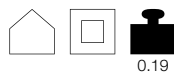

Product details

100-240V ~50/60Hz
 L: 8 cm W: 8 cm H: 2 cm
 Material: Plastic PC

Note

Signal amplifier for inc easing the range of the wall touch panel [470670] and the master controller [470671] / range: Indoors 15 m, outdoors 30 m max., depending on the local conditions. Receive/transmit frequency WLAN 2.4~2.48GHz. Reverse polarity protection, overload; Short-circuit and overheating. Accessories / included: Power supply incl. [prim. 100-240V/50-60Hz, sec. 12Vdc/500mA]

Min. ambient temp. -30°C
 Max. ambient temp. 50°C

BLUETOOTH® ADAPTER



Note

Optional Bluetooth module® for installing in the wall panel [470670] for operation via a Smartphone or tablet with Bluetooth® V2.1 or higher; App iOS, Android available for downloading, Windows in preparation. Communication range 10 m depending on the local conditions. This product can be found on page 833.

Min. ambient temp. -30°C
 Max. ambient temp. 50°C

Variant	Item no.
<input type="checkbox"/> white	470674

Variant	Item no.
<input type="checkbox"/> white	470675





SLV KELVIN CONTROL.

SLV fulfils a wide range of demands and needs regarding modern light control. With SLV KELVIN CONTROL, colour brightness and colour temperature can be controlled independently of each other and adapted to your desired lighting

situation. You decide on the shades of white, from daylight to warm feel-good lighting. Wireless technology using a wall-mounted control panel or with the optional Bluetooth® expansion to control via an App.

YOUR COMPLETE SYSTEM IN EITHER 2 OR 3 STEPS:

TRANSMITTER



RECEIVER



PRODUCT



SLV KELVIN CONTROL
Wall operating panel,
recessed/surface mounted

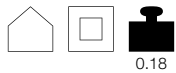

Product details

100-240V ~50/60Hz
Output up to: 2W
Product: W: 8.6 cm H: 8.6 cm D:5 cm
Installation: Ø: 5.5 cm D: 4 cm
Material: Plastic PC

Output up to	2W
Min. ambient temp.	-30°C
Max. ambient temp.	50°C

Variant	Item no.
<input type="checkbox"/> white	470680

SLV KELVIN CONTROL
Remote control



Product details

Prim. voltage: Battery operated
L: 11.4 cm W: 5.6 cm H: 2.4 cm
Material: Plastic PC

Min. ambient temp.	-30°C
Max. ambient temp.	50°C

Variant	Item no.
<input type="checkbox"/> white	470683

SIGNAL AMPLIFIER

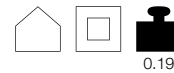

Product details

100-240V ~50/60Hz
L: 8 cm W: 8 cm H: 2 cm
Material: Plastic PC

Note

Signal amplifier for increasing the range of the wall touch panel [470670] and the master controller [470671] / range: Indoors 15 m, outdoors 30 m max., depending on the local conditions. Receive/transmit frequency WLAN 2.4~2.48GHz. Reverse polarity protection, overload; Short-circuit and overheating. Accessories / included: Power supply incl. [prim. 100-240V/50-60Hz, sec. 12Vdc/500mA].

Min. ambient temp.	-30°C
Max. ambient temp.	50°C

Variant	Item no.
<input type="checkbox"/> white	470674

SLV KELVIN CONTROL
Master controller with remote control



Product details

12V DC / 24V DC
Output up to: 72/144W
L: 8.6 cm W: 2.1 cm H: 0.9 cm
Material: Plastic PC

Prim. voltage:	12V DC / 24V DC
Voltage sec.	12V DC / 24V DC
Output current	6000mA
No. of outputs (sec.)	2
Output up to	72/144W
Wattage per output	36 / 72W
Min. ambient temp.	-30°C
Max. ambient temp.	50°C
Temperature protection	110°C

Fault protection	Shut-off temperature
Max. sec. cable L	20m
No. of fuses (sec)	2

Variant	Item no.
<input type="checkbox"/> white	470681

SLV KELVIN CONTROL
Slave controller



Product details

12V DC / 24V DC
Output up to: 72/144W
L: 8.6 cm W: 2.1 cm H: 0.9 cm
Material: Plastic PC

Prim. voltage:	12V DC / 24V DC
Voltage sec.	12V DC / 24V DC
Output current	6000 mA
No. of outputs (sec.)	2
Output up to	72/144W
Wattage per output	36 / 72W
Min. ambient temp.	-30°C
Max. ambient temp.	50°C
Temperature protection	110°C

Fault protection	Shut-off temperature
Max. sec. cable L	20m
No. of fuses (sec)	2

Variant	Item no.
<input type="checkbox"/> white	470682

BLUETOOTH® ADAPTER



Note

Optional Bluetooth® module for installing in the wall panel [470670] for operation via a Smartphone or tablet with Bluetooth V2.1 or higher; App iOS, Android available for downloading, Windows in preparation. Communication range 10m depending on the local conditions.

Min. ambient temp.	-30°C
Max. ambient temp.	50°C

Variant	Item no.
<input type="checkbox"/> white	470675

KELVIN CONTROL STRIP, 24V



240 LEDs per m
 Width / height: 1/0.2 cm
 Can be separated every 5 cm
 Minimum bend radius: 3.8 cm
 For the Kelvin Control System
 Light colour adjustable from 2700K-6500K

3 m, CRI>80

Colour temperature	Luminous flu (lm)	Output (W)	Colour rend. index (CRI)	Colour consistency	L (cm)	Energy efficien index	Item no.
2700K-6500K	1881 – 3921	18 – 36	>80	3SDCM	300	A+	552863
2700K-6500K	3522 – 7230	37.5 – 75				A	552883

To obtain consistent light output from a length of 1.5 m, we recommend supplying power to the strips at both ends.
 For lengths in excess of 3 m, a new power supply must be added.

KELVIN CONTROL STRIP, 24V ACCESSORIES



LED power supply, 36W



LED power supply, 100W

Variant	Max. perm. current	Material	L (cm)	W (cm)	H (cm)	Item no.
■ LED power supply	24V, 36W	Plastic PC	12.9	7.5	3.2	470544
■ LED power supply	24V, 100W	Plastic PC	18.5	8.8	3.5	470500

2700K

3000K

4000K



SLV BLUETOOTH® CONTROL

Advanced wireless light control, simple and everywhere based on Bluetooth® Low Energy (BLE). The SLV BLUETOOTH® CONTROL system allows you to switch light installations on and off and control the brightness. Light installations can be grouped or controlled individually using the app.

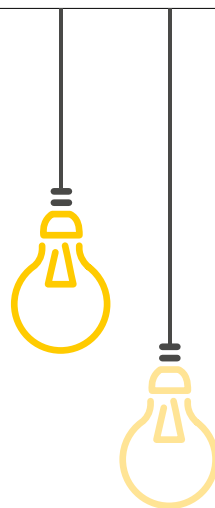

SLV BLUETOOTH® Dimmer wall installation, TRIAC



Product details

220-240V ~50/60Hz
Output: 300W
Dimmable: Triac C, Triac L
L: 4.5 cm W: 4.5 cm H: 2.2 cm
Material: Plastic PC

Note

Can be used as an independent dimmer without Bluetooth. Dimming procedure: Trailing edge. Dimmer for ohmic (high-voltage halogen lamp) and capacitive loads (LED driver). Suitable for any 60mm UP switch socket with a depth of 42mm. Low minimum load of 2W.



Prim. voltage:	220-240V ~50/60Hz
Voltage sec.	220-240VAC
Output current	1.31 mA
No. of outputs (sec.)	1
Output	300W
Watts from	2W
Output up to	300W
Watts/output	300W
Max. ambient temp.	40°C
Fault protection	electronic

Variant	Item no.
<input type="checkbox"/> white	1000826



SLV CONTROL BY TRUST.

MAXIMUM FLEXIBILITY.

Do you want to control your lights or blinds easily using a remote control? Fit switches at a later date where you always need them? Even add further devices into the system? And all of this without needing to cut into walls and lay new power cables? All of this is feasible: take advantage of our solution, particularly when modernising your own four walls.

All transmitters work with radio signals (433/866 MHz) and are specially encoded for our receivers. Other wireless devices - such as modems, telephones or baby monitors - use a different encoding system and/or another frequency. Why is this so important? Because it prevents our receivers being switched on or off unintentionally.

MORE COMFORT IN 3 SIMPLE STEPS:

TRANSMITTER



RECEIVER

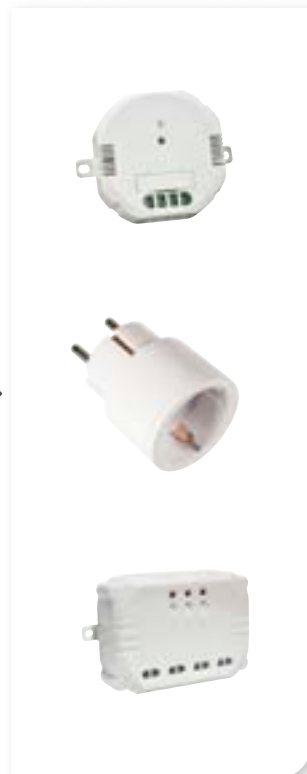

PRODUCT

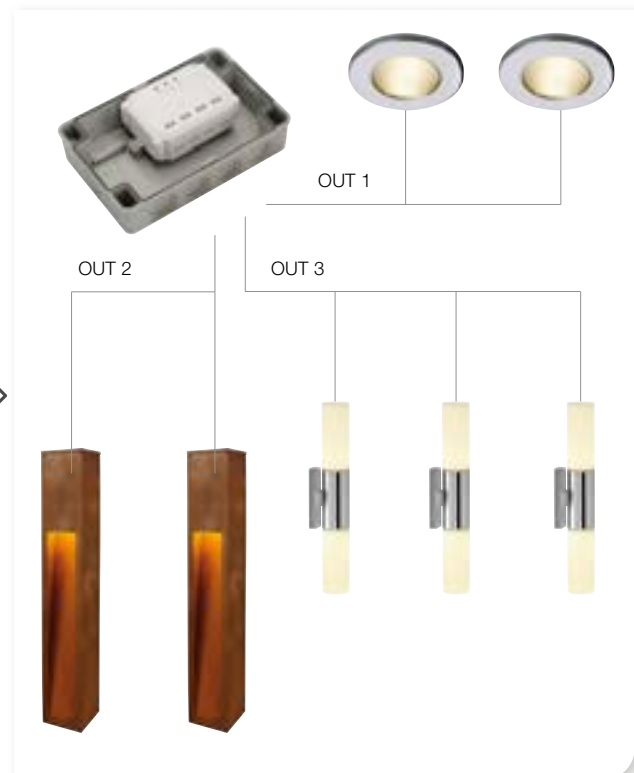

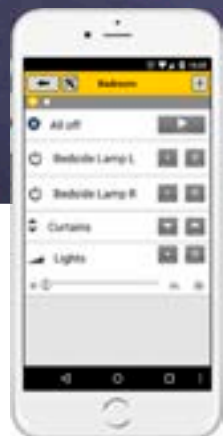

CONTROL LIGHTS; BLINDS AND MUCH MORE

MORE POSSIBILITIES –

our transmitters and receivers can be combined in any way you like and thereby offer you a wide range of application options. Benefit: using a remote controlled radio socket, you can control mobile luminaires easily using the radio remote control. Our wireless system, SLV CONTROL BY TRUST, can be expanded at any time using further components.

MORE COMFORT –

switch or dim from wherever you want, be it at home or on the move. It's extremely easy using SLV CONTROL BY TRUST. For example, using a remote control or even with our App and the Internet Control Station using a Smartphone, tablet PC or your browser on a PC.

MORE SECURITY –

would you like your lighting to switch on automatically without having to operate a switch? For example, when you go down the cellar stairs or at night on the path to your front door from the garage. Not a problem when you use our wireless motion sensors. Another safety-plus of our wireless solution: Using timers, you can simulate being at home and help deter burglars.

TRANSMITTER

SLV CONTROL BY TRUST Wall switch, 1-way

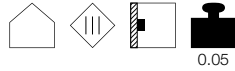

0.05

Product details

Prim. voltage: Battery operated
W: 7.9 cm H: 8 cm D: 1.7 cm
Material: Plastic

Note

Battery CR2032 [incl.] Switch-off delay: 5s
30s, 2min, 10min, 30min, 1h, 3h or permanent
operation/manual switch on/off. Can be fastened
or stuck onto smooth surfaces.

SLV CONTROL BY TRUST 16 channel remote control



0.03

Product details

Prim. voltage: Battery operated
L: 13 cm W: 3.4 cm H: 1.2 cm
Material: Plastic

Note

1x 3V lithium battery CR2032 [incl.]. Automatic
code system. 16 channels with group function.
To control the receiver mode.

SLV CONTROL BY TRUST Internet Control Station ICS 2000

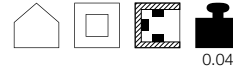

0.04

Product details

100-240V ~50/60Hz
W: 12.7 cm H: 12.6 cm D: 3.3 cm
Material: Plastic

Note

With SLV's free App for iOS or Android, all
pre-programmed lighting scenes/sources/circuits
can be controlled simply and wirelessly. The App
can be obtained for iOS or Android from the
Apple Store / Google Play Store. Also possible
to operate using a web browser. Various times
can be programmed for individual luminaires
and/or lighting sequences. Operation of more
than 200 independent lamps and devices in up
to 16 rooms. Create time switching intervals to
automatically switch the luminaires or devices.
Create sequences with which you can operate
several lamps or devices in a certain order with
just one button. Dawn/Dusk function. Several
tablets/Smartphones can be connected to the
Internet Control Station. Includes power supply
and power cable.

RF range max. (indoor)	30.0 m
RF frequency	433.92 MHz

RF range max. (indoor)	30.0 m
RF frequency	433.92 MHz

RF range max. (indoor)	30.0 m	70.0 m
RF frequency	433.92 MHz	868 MHz

Variant	Item no.
<input type="checkbox"/> white	470812

Variant	Item no.
<input type="checkbox"/> white	470800

Variant	Item no.
<input checked="" type="checkbox"/> black	1001153



Transmitter



Receiver Page 839-840



Product

RECEIVER

SLV CONTROL BY TRUST Wireless socket switch, indoor



0.15

Product details

220-240V ~50/60Hz
Ø: 4.78 cm H: 7 cm
Material: PC

Note

Up to 32 radio transmitters can be taught in.

RF range max. (indoor)	30.0 m
RF frequency	433.92 MHz

Variant	Item no.
<input type="checkbox"/> white	1002409

SLV CONTROL BY TRUST Wireless socket switch, outdoor

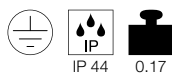

IP 44 0.17

Product details

220-240V ~50/60Hz
Output up to: 3500W
L: 12.3 cm W: 8.3 cm H: 3.7 cm
Material: Plastic

Note

Up to 6 radio transmitters can be taught in.

RF range max. (indoor)	30.0 m
RF range max. (outdoor)	70.0 m
RF frequency	433.92 MHz

Variant	Item no.
<input checked="" type="checkbox"/> black	470808

SLV CONTROL BY TRUST Wireless socket switch, UK

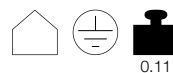

0.11

Product details

220-240V ~50/60Hz
Output up to: 3000W
L: 5.3 cm W: 9.8 cm H: 5.3 cm
Material: PVC

Note

Up to 6 radio transmitters can be taught in.

RF range max. (indoor)	30.0 m
RF frequency	433.92 MHz

Variant	Item no.
<input type="checkbox"/> white	470821

SLV CONTROL BY TRUST Wireless socket switch IT



0.12

Product details

220-240V ~50/60Hz
Output up to: 1000W
W: 5.3 cm H: 9.8 cm D: 7 cm
Material: PVC

Note

Up to 6 radio transmitters can be taught in.

RF range max. (indoor)	30.0 m
RF frequency	433.92 MHz

Variant	Item no.
<input type="checkbox"/> white	470822

SLV CONTROL BY TRUST Radio socket switch BE/FR Indoor



0.11

Product details

220-240V ~50/60Hz
Output up to: 1000W
W: 5.3 cm H: 9.8 cm D: 6.6 cm
Material: PVC

Note

Up to 6 radio transmitters can be taught in.

RF range max. (indoor)	30.0 m
RF frequency	433.92 MHz

Variant	Item no.
<input type="checkbox"/> white	470823

SLV CONTROL BY TRUST Radio socket switch BE/FR Outdoor

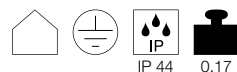

IP 44 0.17

Product details

220-240V ~50/60Hz
Output up to: 3500W
W: 6 cm H: 12.2 cm H: 7.3 cm
Material: PVC

Note

Up to 6 radio transmitters can be taught in.

RF range max. (indoor)	30.0 m
RF range max. (outdoor)	70.0 m
RF frequency	433.92 MHz

Variant	Item no.
<input checked="" type="checkbox"/> black	470824

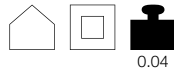

RECEIVER

SLV CONTROL BY TRUST
Radio multi-dimmer installation

0.04

Product details

220-240V ~50/60Hz
Output up to: 200W
W: 6.9 cm H: 5.4 cm D: 2.9 cm
Material: Plastic

Note

Up to 6 radio transmitters can be taught in.
Compatible with conventional bulbs, halogen lamps, compact fluo escent tubes and LED lamps. Not compatible with fluo escent tubes with conventional ballasts.
With halogen lamps, only one transformer per receiver.

No. of outputs (sec.)	1
Output up to	200W
RF range max. (indoor)	30.0 m
RF frequency	433.92 MHz

Variant	Item no.
<input type="checkbox"/> white	470807

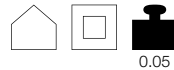
SLV CONTROL BY TRUST
Radio built-in switch

0.05

Product details

220-240V ~50/60Hz
Output up to: 1000W
W: 6.8 cm H: 5.3 cm D: 2.5 cm
Material: Plastic

Note

Up to 6 radio transmitters can be taught in.
Compatible with conventional bulbs, halogen bulbs, compact fluo escent tubes, LED lamps and fluo escent tubes with electronic ballasts.
Not compatible with fluo escent tubes with conventional ballasts.

No. of outputs (sec.)	1
Output up to	1000W
RF range max. (indoor)	30.0 m
RF frequency	433.92 MHz

Variant	Item no.
<input type="checkbox"/> white	470806

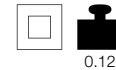
SLV CONTROL BY TRUST
Radio receiver model, 3-channel

0.12

Product details

220-240V ~50/60Hz
Output up to: 3500W
L: 9.8 cm W: 3 cm H: 6.1 cm
Material: Plastic

Note

Radio range up to 30 m indoors (depending on the local conditions). Radio range up to 70 m outdoors (under optimal conditions). Up to 6 radio transmitters can be taught in per channel.
Compatible with conventional bulbs, halogen bulbs, compact fluo escent tubes, LED lamps and fluo escent tubes with electronic ballasts.
Not compatible with fluo escent tubes with conventional ballasts.

No. of outputs (sec.)	3
Output up to	3500W
RF range max. (indoor)	30.0 m
RF frequency	433.92 MHz

Variant	Item no.
<input type="checkbox"/> white	470803

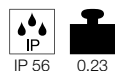
SLV CONTROL BY TRUST
IP56 connection housing, 3 channel

IP 56 0.23

Product details

L: 16.4 cm W: 4.8 cm H: 10.9 cm
Material: Plastic

Note

Screws [incl.], 4 cable glands [incl.] for IP protected installation of the receiver [470803] outdoors.

Variant	Item no.
<input type="checkbox"/> grey	470804

[> Transmitter page 838](#)

Receiver

[> Product](#)



147326 304

228965 540

233650 701

YOUR BEAMING COMPANION.

ACCESSORIES FOR INDIVIDUAL LIGHT AESTHETICS.

There are many different aspects to light. The possibilities are just as numerous when it is a case of lighting rooms and outside areas. These options can be extended with our accessories, and environments can literally be immersed in new light with different light installations.

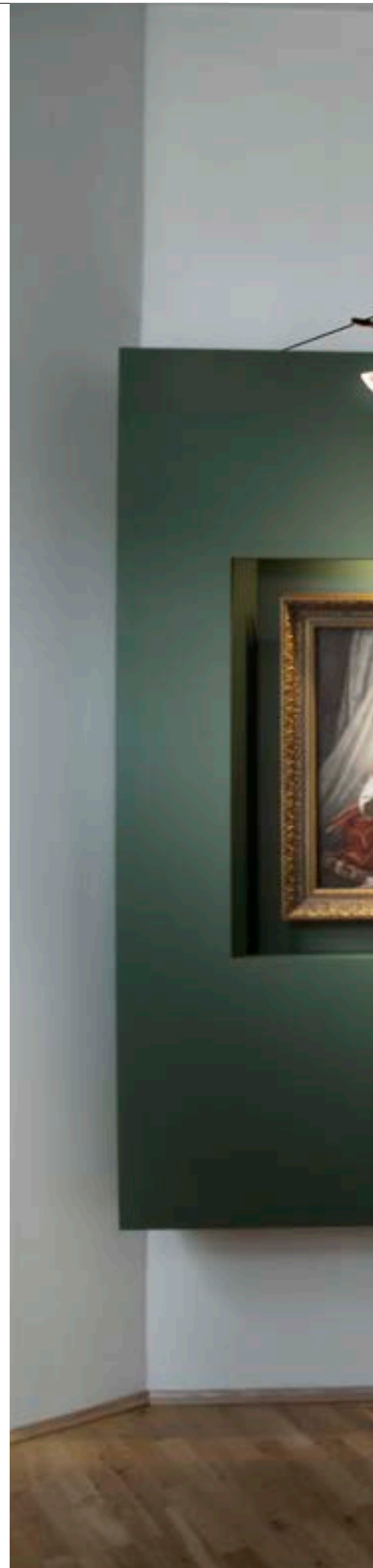



139100 421

FIND A DIMMER. GOOD COMBINATION.

ATMOSPHERIC ROOM LIGHTING THANKS TO THE PERFECT COMBINATION OF LUMINAIRE AND DIMMER. **AT FIND-A-DIMMER.SLV.COM**

Attention must be paid to the compatibility of the luminaires or lamps with the dimmer when dimming. And particularly with LED lamps, it must be checked beforehand which dimmer is required. In view of the many different products, it is not always easy to find the best combination. Our "Find a Dimmer" overview should help you to do this. As well as numerous combinations consisting of different luminaires and lamps and

dimmers, at **find-a-dimme .slv.com** you will also find more information about the minimum number of luminaires or lamps that are needed for problem-free operation. **The overview is updated and extended at regular intervals.**

For specific enquiries, please contact our technical support at **service@slv.de**.



1 Suitable

- Ideal dimming behaviour
- The minimum number of luminaires/ lamps that are needed for problem-free operation is specified as a number.

Conditionally suitable

- No optimum dimming behaviour
- Flickering possible

Not compatible



find-a-dimme .slv.com



ACCESSORIES

<p>Transformers 12V AC</p>  <p>846</p>	<p>IP44 transformers 12V AC</p>  <p>846</p>	<p>TENSEO transformers 12V AC</p>  <p>847</p>	<p>Transformers 12V AC</p>  <p>848</p>
<p>Transformers 12V AC</p>  <p>848</p>	<p>Strip control module VALETO®</p>  <p>848</p>	<p>DALI interface 0-10V</p>  <p>849</p>	<p>DALI Universal Dimmer</p>  <p>849</p>
<p>DALI controller</p>  <p>849</p>	<p>PWM trans-former</p>  <p>849</p>	<p>1-10V Dimmer</p>  <p>849</p>	<p>LED power supplies 12V/24V DC</p>  <p>850</p>
<p>LED power supplies 24V DC</p>  <p>850</p>	<p>LED power supplies 24V DC</p>  <p>851</p>	<p>Compensation module</p>  <p>852</p>	<p>LED driver dimmmable</p>  <p>852-853</p>
<p>LED driver VALETO®</p>  <p>853</p>	<p>LED driver DALI dimmmable</p>  <p>854-855</p>	<p>LED driver non-dimmmable</p>  <p>856-857</p>	<p>Ceiling hook</p>  <p>858</p>
<p>Cable clamp</p>  <p>858</p>	<p>Ceiling plates</p>  <p>859</p>	<p>Textile cable 5 m</p>  <p>859</p>	<p>Textile cable 10 m</p>  <p>859</p>
<p>Cable 10 m clear</p>  <p>859</p>	<p>Wire cable suspension</p>  <p>859</p>	<p>Stopper for wire cable</p>  <p>859</p>	<p>Multiway connector 3 outputs 6 outputs</p>  <p>860-861</p>
<p>Socket GU10</p>  <p>860</p>	<p>Cable extensions 1 m 2 m</p>  <p>860-861</p>	<p>Socket GU10</p>  <p>860</p>	<p>Nepro Display tube kit</p>  <p>861</p>
<p>Double-sided adhesive tape</p>  <p>861</p>	<p>Garden outlets Country-spec. 1.5 m</p>  <p>862</p>	<p>Garden outlets Country-spec. 10 m</p>  <p>863</p>	<p>Energy pack</p>  <p>864</p>
<p>Connection boxes</p>  <p>864</p>	<p>T-connector boxes</p>  <p>864-865</p>	<p>SLV cable</p>  <p>865</p>	<p>Motion sensor Infra-red</p>  <p>865</p>

TRANSFORMER
12V AC | 105VA



Product details

230V ~50Hz
L: 11 cm W: 7.5 cm H: 8 cm
Dimmable: L

Voltage sec.	12V AC
No. of outputs (sec.)	1
Rated output VA	105
Output up to	105W
Temperature protection	110°C

Variant	Item no.
white	451105

TRANSFORMER
12V AC | 300VA



Product details

230V ~50Hz
L: 9 cm W: 13 cm H: 11 cm
Dimmable: L

Voltage sec.	12V AC
No. of outputs (sec.)	1
Rated output VA	300
Output up to	300W
Temperature protection	110°C

Variant	Item no.
white	451301

TRANSFORMER
12V AC | 10VA IP44



Product details

230V ~50Hz
Material: Plastic
L: 7.5 cm W: 5 cm H: 4.5 cm
Dimmable: L

Voltage sec.	12V AC
No. of outputs (sec.)	1
Rated output VA	10
Output up to	10W
Temperature protection	133°C

Variant	Item no.
black	227140

TRANSFORMER
12V AC | 60VA IP44



Product details

230V ~50Hz
Material: Plastic
L: 6 cm W: 10 cm H: 6.3 cm
Dimmable: L

Voltage sec.	12V AC
No. of outputs (sec.)	1
Rated output VA	60
Output up to	60W
Temperature protection	133°C

Variant	Item no.
black	227160

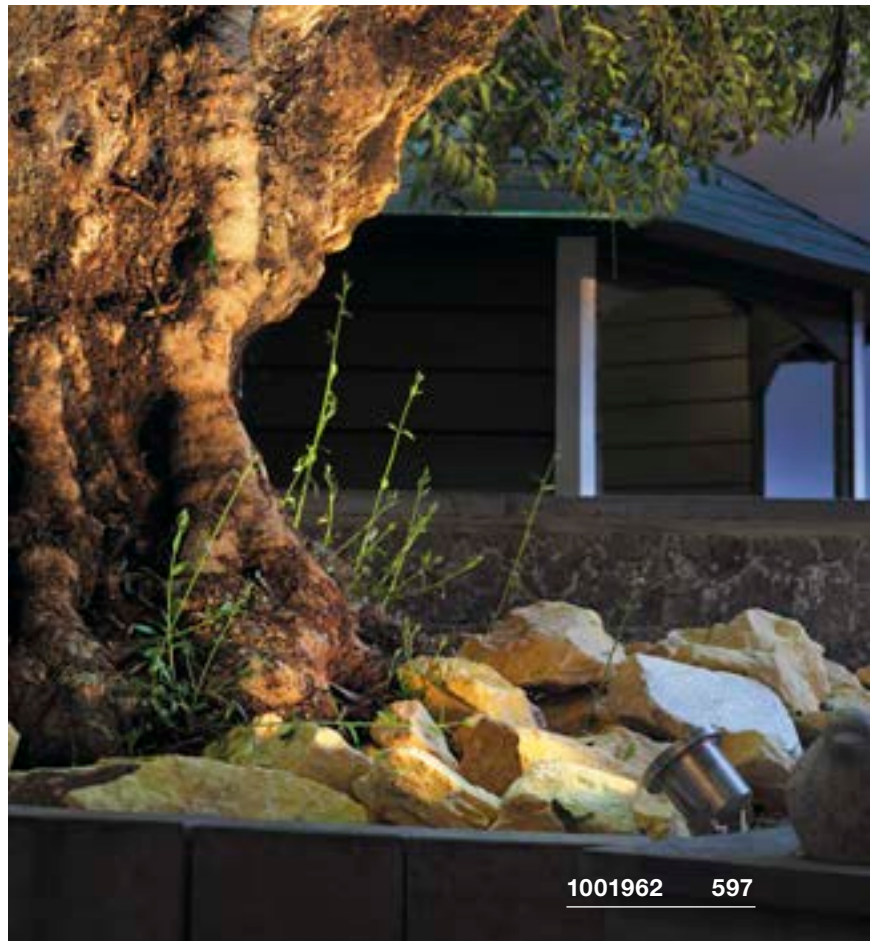

1001962 597

TENSEO TRANSFORMER
12V AC | 50VA



Product details

230V ~50Hz
Material: Steel / Brass
Ø: 11.1 cm H: 11 cm
Dimmable: L

Voltage sec.	12V AC
No. of outputs (sec.)	1
Rated output VA	50
Output up to	50W
Temperature protection	130°C
Fuse (prim.)	1.6A

Variant	Item no.
■ black	1002691
□ white	1002692
■ chrome	1002693

TENSEO TRANSFORMER
12V AC | 105VA

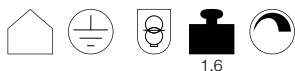

Product details

230V ~50Hz
Material: Steel / Brass
Ø: 11 cm H: 11 cm
Dimmable: L

Voltage sec.	12V AC
No. of outputs (sec.)	1
Rated output VA	105
Output up to	105W
Temperature protection	130°C
Fuse (prim.)	1.6A

Variant	Item no.
■ black	138980
□ white	138981
■ chrome	138982

TENSEO TRANSFORMER
12V AC | 210VA



Product details

230V ~50Hz
Material: Steel / Brass
Ø: 13.5 cm H: 11 cm
Dimmable: L

Voltage sec.	12V AC
No. of outputs (sec.)	1
Rated output VA	210
Output up to	210W
Temperature protection	130°C
Fuse (prim.)	3.15A

Variant	Item no.
■ black	138990
□ white	138991
■ chrome	138992

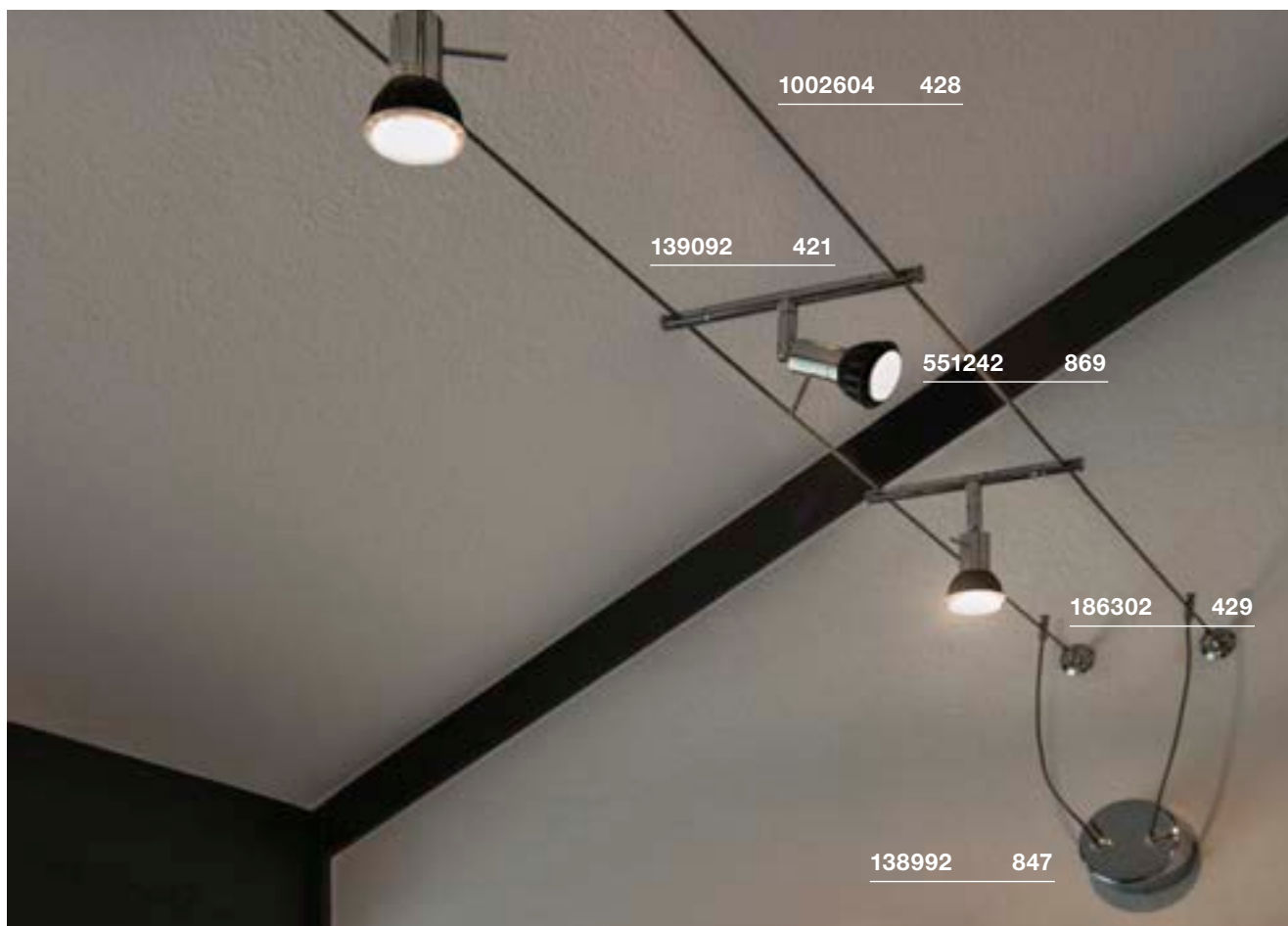

TRANSFORMER
12V AC | 60VA

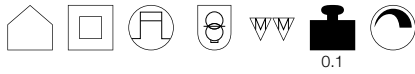

0.1

Product details

230V ~50Hz
Material: Plastic PC
Ø: 5.5 cm D: 2.3 cm
Dimmable: C

Voltage sec.	12V AC
No. of outputs (sec.)	1
Watts from	10W
Output up to	70W
Power factor	0.98
Temperature protection	110°C

Variant	Item no.
white	461050

TRANSFORMER
12V AC | 60VA

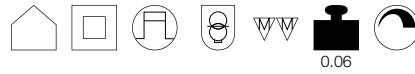

0.06

Product details

230V ~50Hz
Material: Plastic PC
L: 10.5 cm W: 3.3 cm H: 2.2 cm
Dimmable: C

Voltage sec.	12V AC
No. of outputs (sec.)	1
Watts from	10W
Output up to	60W
Power factor	0.98
Temperature protection	110°C

Variant	Item no.
white	461060

TRANSFORMER
12V AC | 150VA

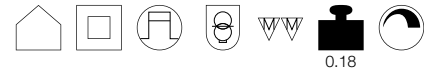

0.18

Product details

230V ~50Hz
Material: Plastic
L: 16.6 cm W: 3.9 cm H: 3.3 cm
Dimmable: C

Voltage sec.	12V AC
No. of outputs (sec.)	3
Watts from	50W
Output up to	150W
Temperature protection	110°C
Fuse (prim.)	3.15A

Variant	Item no.
black	461157

TRANSFORMER
12V AC | 210VA



0.29

Product details

230V ~50Hz
Material: Plastic
L: 20 cm W: 4.3 cm H: 3.9 cm
Dimmable: C

Voltage sec.	12V AC
No. of outputs (sec.)	3
Watts from	50W
Output up to	210W
Temperature protection	110°C
Fuse (prim.)	3.15A

Variant	Item no.
black	461217

SLV VALETO®
12/24V Strip control module | CCT

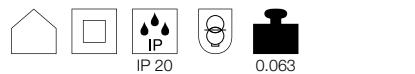

0.063

Product details

12V/24V DC
Output: max. 192W per channel
L: 13.4 cm W: 3.9 cm H: 2.4 cm
Material: Plastic

Note

Can be remote controlled and dimmed using SLV VALETO® CCT/RGBW remote control [1002994] or Gateway [1002411] The control module is suitable for controlling CCT LED strips.

Variant	Item no.
white	1001859

SLV VALETO®
12/24V Strip control module | RGBW

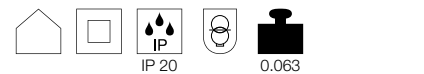

0.063

Product details

12V/24V DC
Output: max. 96W per channel
L: 13.4 cm W: 3.9 cm H: 2.4 cm
Material: Plastic

Note

Can be remote controlled and dimmed using SLV VALETO® CCT/RGBW remote control [1002994] or Gateway [1002411] The control module is suitable for controlling RGBW LED strips.

Variant	Item no.
white	1002892

DALI INTERFACE 0-10V + on/o€

NEW



0.02

Product details

220-240V ~50/60Hz
Material: Plastic
L: 5.85 cm W: 3.25 cm H: 1.5 cm

Note

For actuating electronic ballasts with a 1-10V control input. Switching relay for additional on/o€ switching of the electronic ballast power supply. Galvanic separation of DALI input and 1-10V output.

Output up to 1000W

Variant	Item no.
	1002218

DALI UNIVERSAL DIMMER 3-25W

NEW

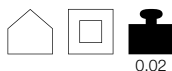

0.02

Product details

220-240V ~50/60Hz
Material: Plastic
L: 5.85 cm W: 3.25 cm H: 1.5 cm

Note

Suitable for R, L and C load thanks to automatic load detection. DALI power consumption: 6mA.

Watts from 3W
Output up to 25W

Variant	Item no.
	1002220

DALI UNIVERSAL DIMMER 10-300W

NEW

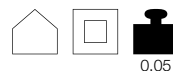

0.05

Product details

220-240V ~50/60Hz
Material: Plastic
L: 12.02 cm W: 3.02 cm H: 2.16 cm

Note

Suitable for R, L and C load thanks to automatic load detection. DALI power consumption: 6mA.

Watts from 10W
Output up to 300W

Variant	Item no.
	1002221

DALI CONTROLLER 24V DC

NEW



0.051

Product details

10-24V DC
Material: Plastic PC
L: 11.6 cm W: 4.2 cm H: 1.8 cm

Note

Suitable for controlling LEDs with a constant voltage of 10-24V / DC – DALI control signal or Push-Dim.

Variant	Item no.
white / grey	1003106

PWM TRANSFORMER 12V DC / 24V DC

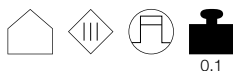

0.1

Product details

12V DC / 24V DC
Material: Plastic PC
L: 17 cm W: 4 cm H: 3 cm

Note

1 channel PWM actuator for dimming LEDs which are operated with a constant voltage of 12V/DC – 24V/DC. 1-10V control signal

Voltage sec. 12V DC / 24V DC
No. of outputs (sec.) 1
Output up to 50 / 100W

Variant	Item no.
white	470550

1-10V DIMMER 10W

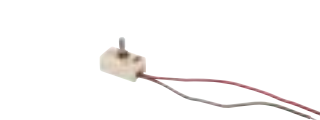

0.04

Product details

10W
Material: Plastic PC
L: 2.3 cm W: 3.9 cm H: 2 cm

Note

Suitable for dimming ballast of 1-10V.

Variant	Item no.
white	470505

LED POWER SUPPLY

12V/24V DC | 12W round

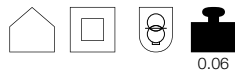

Product details

100-240V ~50/60Hz
Material: Plastic PC
Ø: 5.5 cm H: 2.2 cm

Voltage sec.	12V/24V DC
No. of outputs (sec.)	1
Rated output VA	12
Output up to	12W
Temperature protection	110°C

Variant	Item no.
12V	470545
24V	470546

LED POWER SUPPLY

12V/24V DC | 12W

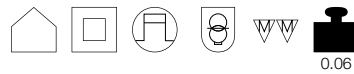

Product details

220-240V ~50/60Hz
Material: Plastic PC
L: 8.5 cm W: 4 cm H: 2.2 cm

Voltage sec.	12V/24V DC
No. of outputs (sec.)	2
Output up to	12W
Temperature protection	110°C

Variant	Item no.
12V	470507
24V	470502

LED POWER SUPPLY

12V/24V DC | 20W

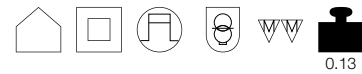

Product details

230V ~50Hz
Material: Plastic PC
L: 16.6 cm W: 3.9 cm H: 3.3 cm

Voltage sec.	12V/24V DC
No. of outputs (sec.)	1
Output up to	20W
Temperature protection	110°C

Variant	Item no.
12V	470541
24V	470542

LED POWER SUPPLY

24V DC | 36W

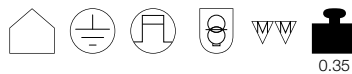

Product details

100-240 V~50/60Hz
Material: Plastic PC
L: 12.9 cm W: 7.5 cm H: 3.2 cm

Voltage sec.	24V DC
No. of outputs (sec.)	1
Output up to	36W
Power factor	0.9
Temperature protection	110°C

Variant	Item no.
■ black	470544

LED POWER SUPPLY

24V DC | 60W

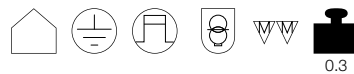

Product details

220-240V ~50/60Hz
Material: Plastic PC
L: 17.5 cm W: 7.8 cm H: 3.5 cm

Voltage sec.	24V DC
No. of outputs (sec.)	2
Output up to	60W
Power factor	0.95
Temperature protection	110°C

Variant	Item no.
□ white	470506

LED POWER SUPPLY

24V DC | 100W

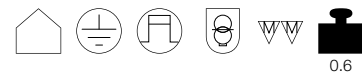
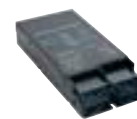

Product details

220-240V ~50/60Hz
Material: Plastic PC
L: 18.2 cm W: 8.8 cm H: 3.5 cm

Voltage sec.	24V DC
No. of outputs (sec.)	2
Output up to	100W
Power factor	0.95
Temperature protection	110°C

Variant	Item no.
■ black	470500

LED POWER SUPPLY
24V DC | 150W

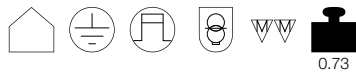

Product details

220-240V ~50/60Hz
Material: Plastic PC
L: 20.7 cm W: 11 cm H: 4.5 cm

Voltage sec.	24V DC
No. of outputs (sec.)	1
Output up to	150W
Temperature protection	110°C

Variant	Item no.
■ black	470549

LED POWER SUPPLY
24V DC | 150W



Product details

220-240V ~50/60Hz
Material: Plastic PC
L: 23.4 cm W: 11.4 cm H: 4.9 cm

Voltage sec.	24V DC
No. of outputs (sec.)	1
Output up to	150W
Temperature protection	110°C

Variant	Item no.
■ black	470548

LED POWER SUPPLY
24V DC | 20W



Product details

220-240V ~50/60Hz
Material: Plastic PC
L: 14.6 cm W: 5.5 cm H: 1.9 cm
Dimmable: 1-10V

Voltage sec.	24V DC
No. of outputs (sec.)	1
Output up to	20W
Temperature protection	100°C

Variant	Item no.
□ white	470547

LED POWER SUPPLY
24V DC | 100W



Product details

220-240V ~50/60Hz
Material: Plastic PC
L: 19 cm W: 13 cm H: 3.5 cm
Dimmable: 1-10V

Voltage sec.	24V DC
No. of outputs (sec.)	3
Output up to	100W
Watts/output	33W
Power factor	0.95
Temperature protection	110°C
Fault protection	Short circuit and open circuit-proof °C

Variant	Item no.
■ black	470540

LED POWER SUPPLY
24V | 50W

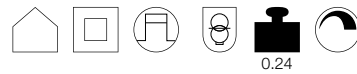

Product details

220-240V ~50/60Hz
Material: Plastic PC
L: 18.4 cm W: 6.1 cm H: 3.2 cm
Dimmable: C

Voltage sec.	24V DC
Watts from	12W
Output up to	50W
Temperature protection	110°C

Variant	Item no.
■ white / blue	1003104

LED POWER SUPPLY
24V | 100W



Product details

220-240V ~50/60Hz
Material: Plastic PC
L: 21 cm W: 6.7 cm H: 3.4 cm
Dimmable: C

Voltage sec.	24V DC
Watts from	34W
Output up to	100W
Temperature protection	110°C

Variant	Item no.
■ white / blue	1003105

COMPENSATION MODULE

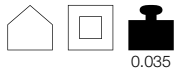

Product details

220-240V ~50/60Hz
Material: Plastic PC
L: 9.5 cm Ø: 1.5 cm

Note

Reduces or rectifies dimming problems such as flickering, flashing or if the LED lighting does not go to 100% when it is switched on.
The compensator is always connected downstream of the dimmer or switch and in parallel to the downlight spot or LED driver.

Variant	Item no.
<input checked="" type="checkbox"/> black	1002785

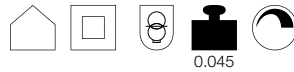
LED DRIVER
350mA | 6W

Product details

220-240V ~50/60Hz
Material: Plastic PC
L: 6.3 cm W: 4 cm H: 2.3 cm
Dimmable: C

Voltage sec.	10-17V DC
Watts from	3.5W
Output up to	5.9W
Power factor	0.9
Temperature protection	110°C

Variant	Item no.
<input type="checkbox"/> white	1002791

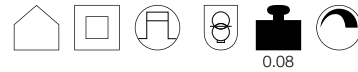
LED DRIVER
350mA | 10W

Product details

220-240V ~50/60Hz
Material: Plastic PC
L: 8.5 cm W: 4.1 cm H: 2.2 cm
Dimmable: C

Voltage sec.	17-29V DC
Output current	350mA
Output	10W
Watts from	5.95W
Output up to	10.15W
Power factor	0.9
Temperature protection	110°C

Variant	Item no.
<input type="checkbox"/> white	464140

LED DRIVER
350mA | 15W

Product details

220-240V ~50/60Hz
Material: Plastic PC
L: 8.5 cm W: 4.1 cm H: 2.2 cm
Dimmable: C

Voltage sec.	18-30V DC
Output current	350mA
Watts from	9W
Output up to	15W
Power factor	0.9
Temperature protection	110°C

Variant	Item no.
<input type="checkbox"/> white	1002803

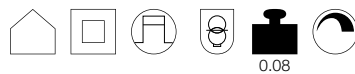
LED DRIVER
500mA | 15W

Product details

220-240V ~50/60Hz
Material: Plastic PC
L: 8.5 cm W: 4.1 cm H: 2.2 cm
Dimmable: C

Voltage sec.	26-43V DC
Output current	500mA
Watts from	9.1W
Output up to	15W
Power factor	0.9
Temperature protection	110°C

Variant	Item no.
<input type="checkbox"/> white	464144

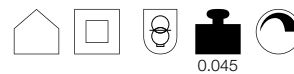
LED DRIVER
700mA | 6W

Product details

220-240V ~50/60Hz
Material: Plastic PC
L: 6.3 cm W: 4 cm H: 2.3 cm
Dimmable: C

Voltage sec.	4.8-8.6V
Output current	700mA
Watts from	3.4W
Output up to	6W
Power factor	0.9
Temperature protection	110°C

Variant	Item no.
<input type="checkbox"/> white	1002792

Note

Suitable for flush-mounted sockets Ø 60 mm and a min. installation depth of 42 mm

LED DRIVER
700mA | 10W incl. strain relief

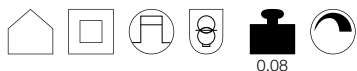

Product details

220-240V ~50/60Hz
Material: Plastic PC
L: 8.5 cm W: 4.1 cm H: 2.2 cm
Dimmable: C

Voltage sec.	40-57V
Output current	700mA
Watts from	6W
Output up to	10.5W
Power factor	0.9
Temperature protection	110°C

Variant	Item no.
<input type="checkbox"/> white	464142

TRIAC LED DRIVER
700mA | 39W incl. strain relief

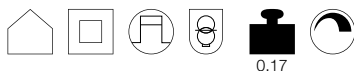

Product details

220-240V ~50/60Hz
Material: PC
L: 16.6 cm W: 5.2 cm H: 2.4 cm
Dimmable: C

Voltage sec.	28-56V
Output current	700mA
Watts from	20W
Output up to	39W
Power factor	0.95
Temperature protection	110°C

Variant	Item no.
<input checked="" type="checkbox"/> white / blue	1001267

LED DRIVER
700mA | 40W incl. strain relief

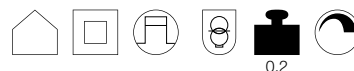

Product details

220-240V ~50/60Hz
Material: Plastic PC
L: 15.3 cm W: 6.7 cm H: 3 cm
Dimmable: C

Voltage sec.	40-57V
Output current	700mA
Watts from	28W
Output up to	39.9W
Power factor	0.9
Temperature protection	110°C

Variant	Item no.
<input type="checkbox"/> white	1001114

LED DRIVER
1000mA

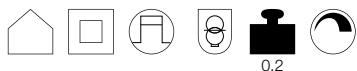

Product details

220-240V ~50/60Hz
Material: Plastic PC
L: 15.3 cm W: 6.7 cm H: 3 cm
Dimmable: C

Voltage sec.	28-40V
Output current	1000mA
No. of outputs (sec.)	1
Output	40W
Watts from	28W
Output up to	40W
Power factor	0.9
Temperature protection	110°C

Variant	Item no.
<input type="checkbox"/> white	1001115

LED DRIVER
1050mA | 40W incl. strain relief

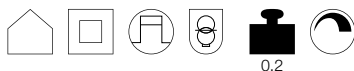

Product details

220-240V ~50/60Hz
Material: Plastic PC
L: 16.6 cm W: 5.2 cm H: 2.4 cm
Dimmable: C

Voltage sec.	19-38
Output current	1050mA
No. of outputs (sec.)	2
Output up to	40W
Power factor	0.95
Temperature protection	110°C

Variant	Item no.
<input type="checkbox"/> white	464804

SLV VALETO®
15W, LED driver

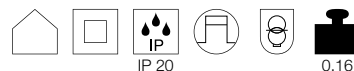

Product details

220-240V ~50/60Hz
Output: 15W
L: 19 cm W: 6.1 cm H: 3 cm
Material: Plastic

Note

Can be remote controlled and dimmed using SLV VALETO® CCT/RGBW remote control [1002994] or Gateway [1002411]

Variant	Item no.
<input type="checkbox"/> white	1002082



DALI – THE FLEXIBLE LIGHTING SOLUTION

What is DALI? DALI is a system for freely configuring flexible light scenarios and arrangements. This bus-compatible system makes it possible to individually access, control and evaluate light and all components of a lighting system. Luminaires, groups of luminaires and even the lighting of entire buildings are controlled in this way.

You can create a special atmosphere in your retail premises with our DALI system. Your lighting is configured in a flexible way by using DALI spotlights in conjunction with our special DALI adapters and tracks. Thanks to the wide range of accessories, any configuration that is required can be realised. Be it ceiling or wall installation, or as a pendant.

The tracks consist of an extruded aluminium profile that is painted in white or black. The tracks are available in different lengths with an integrated 2-core DALI cable, and can be cut to length in accordance with requirements. Suitable luminaires with a high CRI of >90 are also available for this system.

LED DRIVER DALI
250-700mA | 20W



Product details

220-240V ~50/60Hz
Material: PC
L: 15 cm W: 5.2 cm H: 2.8 cm
Dimmable: 1-10V / Dali

Note

250/350/500/700mA
Output current adjustable via DIP switch

Voltage sec.	6-60V
Watts from	1.5W
Output up to	20W
Temperature protection	110°C
Power factor	0.9

Variant	Item no.
<input type="checkbox"/> white	1002423

LED DRIVER DALI
250-700mA | 40W

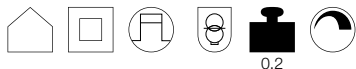

Product details

220-240V ~50/60Hz
Material: PC
L: 12.3 cm W: 7.9 cm H: 2.4 cm
Dimmable: 1-10V / Dali

Note

250/350/500/700mA
Output current adjustable via DIP switch

Voltage sec.	6-58V
Watts from	1.5W
Output up to	40W
Temperature protection	110°C
Power factor	0.9

Variant	Item no.
<input type="checkbox"/> white	1002424

LED DRIVER DALI
700-1500mA | 50W



Product details

220-240V ~50/60Hz
Material: PC
L: 12.3 cm W: 7.9 cm H: 2.4 cm
Dimmable: 1-10V / Dali

Note

700/800/900/1050/1200/1300/1400mA
Output current adjustable via DIP switch

Voltage sec.	6-58V
Watts from	4.2W
Output up to	50W
Temperature protection	110°C
Power factor	0.9

Variant	Item no.
<input type="checkbox"/> white	1002425

LED DRIVER DALI
350-1050mA | 60W

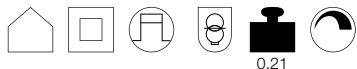

Product details

220-240V ~50/60Hz
Material: PC
L: 12.4 cm W: 7.9 cm H: 2.2 cm
Dimmable: 1-10V / Dali

Note

350/500/550/650/700/750/850/900/1000/1050mA
Output current adjustable via DIP switch

Voltage sec.	2-74V
Watts from	1W
Output up to	60W
Temperature protection	110°C
Power factor	0.95

Variant	Item no.
<input type="checkbox"/> white	464032

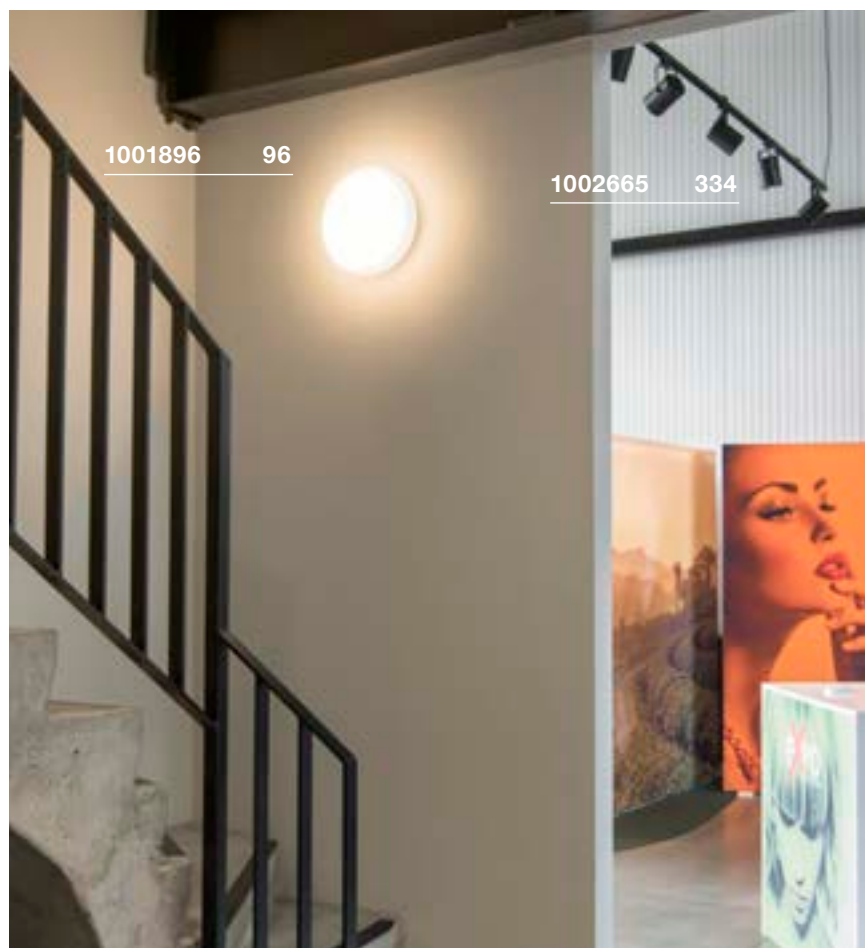

LED DRIVER
320mA | 3W



0.05

Product details

100-240V ~50/60Hz
Material: Plastic PC
L: 5.5 cm W: 3.9 cm H: 2 cm

Voltage sec.	3-9V
Output current	320mA
Watts from	1W
Output up to	3W
Power factor	0.4
Temperature protection	110°C
Max. sec. cable L	2 m

Variant	Item no.
<input type="checkbox"/> white	464108

LED DRIVER
350mA | 3W



0.04

Product details

230V ~50Hz
Material: Plastic PC
L: 5.6 cm W: 3.9 cm H: 2 cm

Note

Includes AMP plug 350mA

Voltage sec.	3-9V
Output current	350mA
Watts from	1W
Output up to	3W
Power factor	0.4
Temperature protection	110°C
Max. sec. cable L	2 m

Variant	Item no.
<input type="checkbox"/> white	464107

LED DRIVER
350mA | 9W

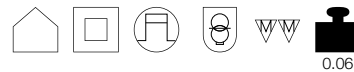

0.06

Product details

230V ~50Hz
Material: Plastic PC
L: 8.5 cm W: 4.1 cm H: 2.2 cm

Voltage sec.	3-26V
Output current	350mA
Watts from	1W
Output up to	9W
Power factor	0.4
Temperature protection	110°C
Max. sec. cable L	2 m

Variant	Item no.
<input type="checkbox"/> white	464109

LED DRIVER
350mA incl. strain relief



0.05

Product details

220-240V ~50/60Hz
Material: Plastic PC
L: 15.8 cm W: 2.2 cm H: 1.9 cm

Output current	350mA
No. of outputs (sec.)	1
Output up to	15W
Power factor	0.6
Temperature protection	100°C

Variant	Item no.
<input type="checkbox"/> white	464031

LED DRIVER
500mA | 9W



0.05

Product details

100-240V ~50/60Hz
Material: Plastic PC
L: 6.5 cm W: 3.9 cm H: 2 cm

Voltage sec.	12-19V
Output current	500mA
No. of outputs (sec.)	1
Watts from	6W
Output up to	9W
Power factor	0.9
Temperature protection	110°C
Max. sec. cable L	2 m

Variant	Item no.
<input type="checkbox"/> white	464091

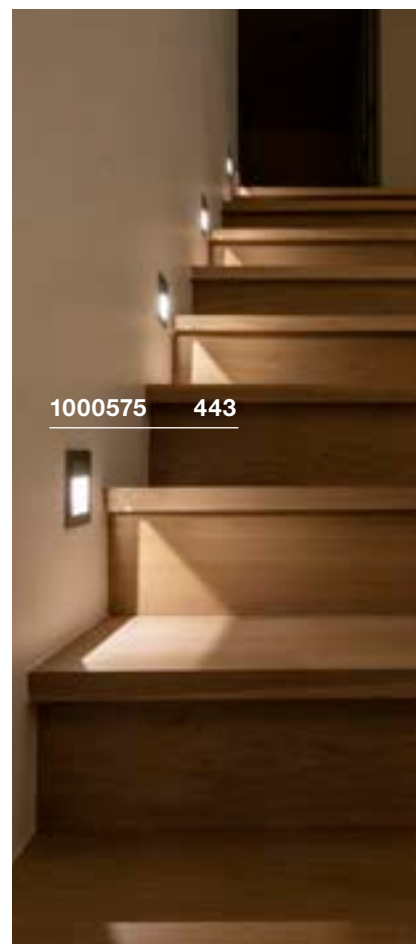

1000575 443

LED DRIVER
700mA | 3W incl. strain relief



Product details

230V ~50Hz
Material: Plastic PC
L: 5.5 cm W: 3.9 cm H: 2 cm

Voltage sec.	4-5V
Output current	700mA
Output up to	3W
Power factor	0.4
Temperature protection	110°C
Max. sec. cable L	2 m

Variant	Item no.
<input type="checkbox"/> white	464200

LED DRIVER
700mA | 11W incl. strain relief

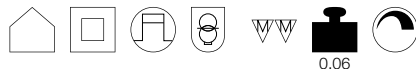

Product details

220-240V ~50/60Hz
Material: Plastic PC
L: 15.5 cm W: 2.2 cm H: 1.9 cm

Output current	700mA
Output up to	11W
Power factor	0.6
Temperature protection	100°C

Variant	Item no.
<input type="checkbox"/> white	464030

LED DRIVER
700mA | 40W incl. strain relief

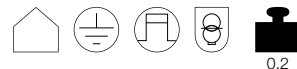

Product details

100-240V ~50/60Hz
Material: Plastic PC
L: 12.9 cm W: 7.5 cm H: 3.2 cm

Voltage sec.	29-58V
Output current	700mA
Watts from	20W
Output up to	40W
Power factor	0.9
Temperature protection	110°C
Max. sec. cable L	2 m

Variant	Item no.
<input checked="" type="checkbox"/> black	464168

VALETO® LED DRIVER
1050mA

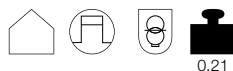

Product details

100-240V ~50/60Hz
Material: Plastic
L: 19 cm W: 6.1 cm H: 3 cm

Note

Can be remote controlled and dimmed with Gateway [1002411]

Voltage sec.	30-42V
Output current	1050mA
No. of outputs (sec.)	1
Output	42W
Watts from	31.5W
Output up to	45W
Power factor	0.95
Temperature protection	110°C
Max. sec. cable L	2 m

Variant	Item no.
<input type="checkbox"/> white	1001249

LED DRIVER
1000mA | 40W incl. strain relief



Product details

100-240V ~50/60Hz
Material: Plastic PC
L: 12.9 cm W: 7.5 cm H: 3.2 cm

Voltage sec.	20-40V
Output current	1000mA
No. of outputs (sec.)	1
Watts from	20W
Output up to	40W
Power factor	0.9
Temperature protection	110°C
Max. sec. cable L	2 m

Variant	Item no.
<input checked="" type="checkbox"/> black	464170

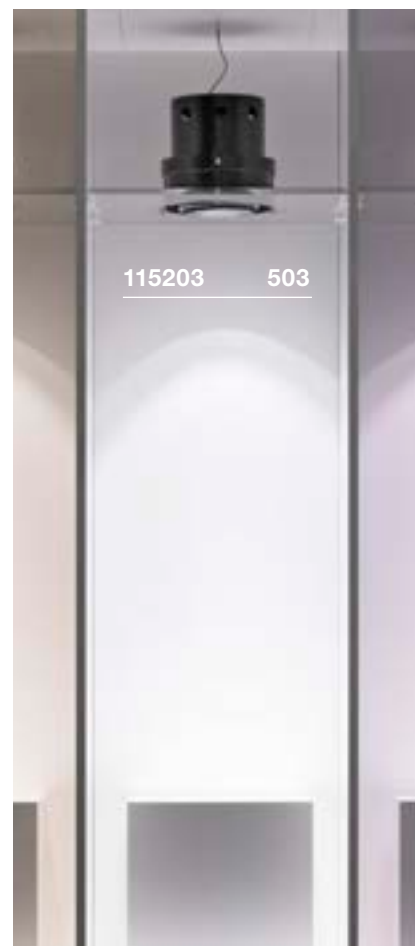

CEILING HOOK



0.04

Product details

Material: Aluminium
 Ø: 1.8 cm L: 4.6 cm

CEILING HOOK



0.04

Product details

Material: Aluminium
 Ø: 1.8 cm L: 4.6 cm

Variant	Item no.
<input checked="" type="checkbox"/> black	132670

Variant	Item no.
<input type="checkbox"/> white	132671

CABLE CLAMP



0.01

Product details

Material: Aluminium
 Ø: 1.4 cm L: 3.1 cm

CABLE CLAMP



0.01

Product details

Material: Aluminium
 Ø: 1.4 cm L: 3.1 cm

Variant	Item no.
<input checked="" type="checkbox"/> black	132680

Variant	Item no.
<input type="checkbox"/> white	132681

132670 858



132680 858



CEILING PLATE

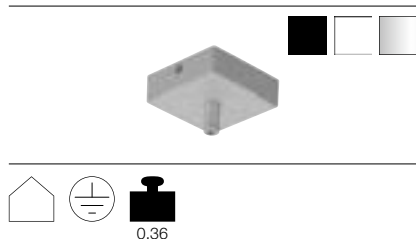

Product details

230V ~50Hz
 Material: Aluminium
 L: 8.5 cm W: 8.5 cm H: 2.7 cm

Max. perm. current 8.5mA

Variant	Item no.
■ matt black	210060
□ matt white	210061
■ silver	210064

TEXTILE CABLE
 3-pin, 3 x 0.75 mm², 5 m



Product details

Max. voltage 300V
 Max. ambient temp. 70°C
 Material: PVC
 Ø: 0.6 cm L: 500 cm

Variant	Item no.
■ black	961370
□ white	961371
■ red	961376

TEXTILE CABLE
 3-pin, 3 x 0.75 mm², 10m



Product details

Max. voltage 300V
 Material: PVC
 Ø: 0.6 cm L: 1000 cm

Variant	Item no.
■ black	961270
□ white	961271
■ red	961276

CABLE

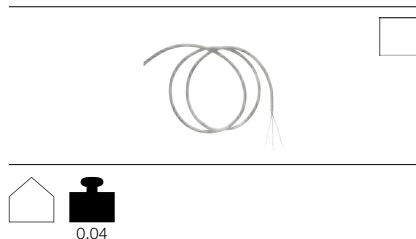

Product details

Max. voltage 300V
 L: 1000 cm

Variant	Item no.
□ transparent	961250

WIRE CABLE SUSPENSION

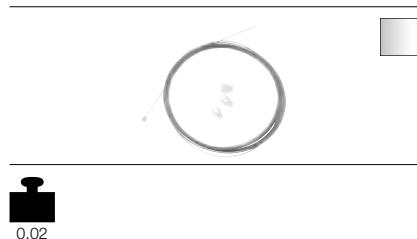

Product details

Material: Steel / Plastic
 Ø: 0.15 cm L: 500 cm

Variant	Item no.
■ silver	961037

Mech. max. load 40 kg

STOPPER FOR WIRE CABLE

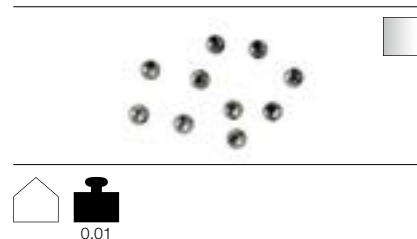

Product details

Material: Steel
 Ø: 0.8 cm

Variant	Item no.
■ silver	961034

MULTIWAY CONNECTOR

3 outputs



Product details

Material: Plastic
L: 5.2 cm W: 1.4 cm H: 1.3 cm

Note

For 350mA plug-in system

Variant	Item no.
■ black	111850

MULTIWAY CONNECTOR

6 outputs

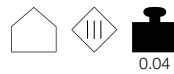

Product details

Material: Plastic
L: 5.2 cm W: 3 cm H: 1.3 cm

Note

For 350mA plug-in system

Variant	Item no.
■ black	111860

GU10 SOCKET

With connection box and quick terminal



Product details

L: 27 cm

Variant	Item no.
■ white / black	1000909

CABLE EXTENSION

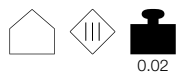

Product details

Material: Plastic
L: 100 cm

Note

With AMP plug and coupling
For 350mA plug-in system

Variant	Item no.
■ black	111861

CABLE EXTENSION

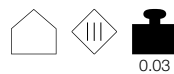

Product details

Material: Plastic
L: 200 cm

Note

With AMP plug and coupling
For 350mA plug-in system

Variant	Item no.
■ black	111862

GU10 SOCKET



Product details

230V ~50Hz
Material: Ceramic
L: 300 cm W: 0.9 cm

Variant	Item no.
□ white	955135

NEPRO DISPLAY TUBE KIT



Product details

Material: Plastic

Note

Pipe kit, 2-part, plastic. For attaching to pipes and bars with a diameter of 32-42 mm.

Variant	Item no.
■ black	146479

MULTIWAY CONNECTOR
3 outputs



0.02

Product details

Material: Plastic
L: 5.5 cm W: 1.4 cm H: 1.2 cm

Note

For 700mA plug-in system

Variant	Item no.
■ black	111830

MULTIWAY CONNECTOR
6 outputs



0.03

Product details

Material: Plastic
L: 5.1 cm W: 2.9 cm H: 1.2 cm

Note

For 700mA plug-in system

Variant	Item no.
■ black	111831

DOUBLE-SIDED
ADHESIVE TAPE



Product details

L: 300 cm W: 0.9 cm

Variant	Item no.
□ clear	220000

CABLE EXTENSION



0.01

Product details

Material: Plastic
L: 100 cm

Note

With AMP plug and coupling
For 700mA plug-in system

Variant	Item no.
■ black	111832

CABLE EXTENSION



0.02

Product details

Material: Plastic
L: 200 cm

Note

With AMP plug and coupling
For 700mA plug-in system

Variant	Item no.
■ black	111833

4-WAY GARDEN SOCKET



0.9 IP 44

Product details

230V ~50Hz
Material: Plastic
L: 10.5 cm W: 13 cm H: 21 cm
Connection lead length: 1.5 m

Note

For use in Germany.

Max. perm. current 16mA

Variant	Item no.
■ black	1000868

4-WAY GARDEN SOCKET



0.92 IP 44

Product details

230V ~50Hz
Material: Plastic
L: 10.5 cm W: 13 cm H: 21 cm
Connection lead length: 1.5 m

Note

For use in France.

Max. perm. current 16mA

Variant	Item no.
■ black	1000869

4-WAY GARDEN SOCKET

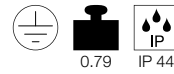

0.79 IP 44

Product details

230V ~50Hz
Material: Plastic
L: 10.5 cm W: 13 cm H: 21 cm
Connection lead length: 1.5 m

Note

For use in Switzerland.

Max. perm. current 10mA

Variant	Item no.
■ black	1000870

4-WAY GARDEN SOCKET



0.93 IP 44

Product details

230V ~50Hz
Material: Plastic
L: 14.5 cm W: 13 cm H: 21 cm
Connection lead length: 1.5 m

Note

For use in Great Britain.

Max. perm. current 13mA

Variant	Item no.
■ black	1000871

4-WAY GARDEN SOCKET



0.9 IP 44

Product details

230V ~50Hz
Material: Plastic
L: 10.5 cm W: 13 cm H: 21 cm
Connection lead length: 1.5 m

Note

For use in Denmark.

Max. perm. current 10mA

Variant	Item no.
■ black	1000872

4-WAY GARDEN SOCKET

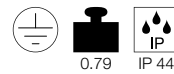

0.79 IP 44

Product details

230V ~50Hz
Material: Plastic
L: 10.8 cm W: 12.7 cm H: 21 cm
Connection lead length: 1.5 m

Note

For use in Italy.

Max. perm. current 10mA

Variant	Item no.
■ black	1000873

4-WAY GARDEN SOCKET



2.09 IP 44

Product details

230V ~50Hz
Material: Plastic
L: 10.5 cm W: 13 cm H: 21 cm
Connection lead length: 10 m

Note

For use in Germany.

Max. perm. current 16mA

Variant	Item no.
■ black	1000874

4-WAY GARDEN SOCKET



2.21 IP 44

Product details

230V ~50Hz
Material: Plastic
L: 10.5 cm W: 13 cm H: 21 cm
Connection lead length: 10 m

Note

For use in France.

Max. perm. current 16mA

Variant	Item no.
■ black	1000875

4-WAY GARDEN SOCKET

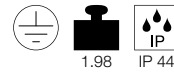

1.98 IP 44

Product details

230V ~50Hz
Material: Plastic
L: 10.5 cm W: 13 cm H: 21 cm
Connection lead length: 10 m

Note

For use in Switzerland.

Max. perm. current 10mA

Variant	Item no.
■ black	1000876

4-WAY GARDEN SOCKET



2.12 IP 44

Product details

230V ~50Hz
Material: Plastic
L: 14.5 cm W: 13 cm H: 21 cm
Connection lead length: 10 m

Note

For use in Great Britain.

Max. perm. current 13mA

Variant	Item no.
■ black	1000877

4-WAY GARDEN SOCKET



2.09 IP 44

Product details

230V ~50Hz
Material: Plastic
L: 10.5 cm W: 13 cm H: 21 cm
Connection lead length: 10 m

Note

For use in Denmark.

Max. perm. current 10mA

Variant	Item no.
■ black	1000878

4-WAY GARDEN SOCKET



1.98 IP 44

Product details

230V ~50Hz
Material: Plastic
L: 10.8 cm W: 12.7 cm H: 21 cm
Connection lead length: 10 m

Note

For use in Italy.

Max. perm. current 10mA

Variant	Item no.
■ black	1000879

ENERGY PACK 230V



Product details

230V ~50Hz
Material: Steel / Plastic
L: 35 cm W: 12 cm H: 12 cm

Note

Only drivers that are suitable for outdoors may be housed in the energy pack.
3 outputs for metric cable gland in accordance with EN 50262 M12.
1 input for metric cable gland in accordance with EN 50262 M25.

Max. perm. current 16mA

Variant	Item no.
grey	227000

CONNECTION BOX



Product details

230V ~50Hz
Material: PA66 GF
Ø: 2.7 cm L: 11.5 cm

Note

3-pin

Max. perm. voltage 450V
Max. perm. current 17.5mA

Variant	Item no.
black	228730

CONNECTION BOX



Product details

230V ~50Hz
Material: PA66 GF
Ø: 3.2 cm L: 13 cm

Note

5-pin

Max. perm. voltage 450V
Max. perm. current 32mA

Variant	Item no.
black	228725

CONNECTION BOX 4-way



Product details

230V ~50Hz
Material: PP
Ø: 7.2 cm L: 16 cm

Note

Max. cable diameter 5-14 mm

Max. perm. voltage 1000V

Variant	Item no.
yellow / black	229269

T-CONNECTOR BOX



Product details

230V ~50Hz
Material: PA 66
L: 11 cm W: 6.4 cm H: 3 cm

Max. perm. voltage 500V
Max. perm. current 17.5mA

Variant	Item no.
black	228726

T-CONNECTOR BOX



Product details

230V ~50Hz
Material: PA 66
Ø: 15.5 cm H: 4.6 cm

Max. perm. voltage 500V

Variant	Item no.
black	229260

T-CONNECTOR BOX



0.18 IP 67

Product details

230V ~50Hz
Material: PA 66
L: 25 cm W: 4.5 cm H: 6 cm

Max. perm. voltage 500V

Variant	Item no.
■ black	229262



SLV CABLE H05RN-F



1.9

Product details

300V /500V
Material: Copper / Rubber
Ø: 7.2 cm L: 2000 cm
3-wire

Variant	Item no.
■ black	1000700

SLV CABLE H07RN-F



2.63

Product details

450V /750V
Material: Copper / Rubber
Ø: 9.1 cm L: 2000 cm
3-wire

Variant	Item no.
■ black	1000701

MOTION SENSOR Infra-red



0.15 IP 44

Product details

220-240V ~50Hz
Material: Plastic
W: 6.5 cm H: 9.5 cm D: 10 cm

Note

Detection angle 180°. Range max. 12 m. Switch-on time controllable between approx. 10 seconds and approx 4 minutes.

Variant	Item no.
□ white	410861
■ anthracite	410865

THE SOURCE OF ALL LIGHT.

THE RIGHT LAMP FOR ANY LIGHTING SOLUTION.

The right lighting effect is the result of perfect interaction between the luminaire and the lamp. As well as the design, energy efficiency is also an important criterion. Many alternatives to the classic light bulb have gained a foothold on the market in recent years. This means that the right lighting element is available for every kind of application or luminaire.

LAMPS

GENERAL INFORMATION.

- The energy efficiency indexes specified correspond to European Council Regulation No. 874/2012. The energy stickers for the individual articles are available to download at slv.com.
- Operating in open luminaires without protection glass is only permitted with low-pressure lamps. Lamps with this symbol (IEC 357 standard) are suitable for use in luminaires without protection glass.
- Halogen lamps and metal halide discharge lamps (HID) can cause the lamp housing to heat up. The latter may therefore only be touched when they have cooled down. Adjustable luminaires or lamp heads which do not have an adjusting handle fitted or which are used with lamps at the maximum wattage meaning that the maximum housing temperature permitted is exceeded on the obvious adjustment point, must be installed out of hands' reach. Our LED retrofit lamps are available as a low temperature alternative for most of our halogen luminaires. You can find corresponding solutions in this chapter.
- Low-voltage lamps can be operated using suitable LED retrofit lamps in many cases. However, not every combination of luminaires with apparently suitable lamps is possible due to the conflicting individual cases, where there are transformer and LED technology-specific issues. If you have any questions about compatibility, visit slv.com or contact our sales department.
- The dimensions specified for the lamps always refer to the complete exterior dimensions of a lamp. This means that the threaded base is included.
- **All bulbs must be disposed of separately and do not belong in the household waste.**



LED QT14
G9A+ Range
A++-E

Product details

220-240V ~50/60Hz
Output: 2.5W
Ø: 1.6 cm L: 4.8 cm

Lamp current	0.012A
Output	2.5W
Energy consump./1000h	3kWh
Colour temperature	3000K
Luminous flu	180lm
Colour rendering index	>80

Variant	Item no.
	560302

LED FILAMENT
G9A+ Range
A++-E

NEW

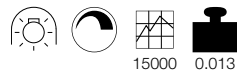

Product details

220-240V ~50/60Hz
Output: 2.7W
Ø: 1.4 cm L: 6.8 cm
Dimmable: C

Lamp current	0.0135A
Output	2.7W
Energy consump./1000h	3kWh
Colour temperature	2600K
Luminous flu	250lm
Colour rendering index	>90

Variant	Item no.
	1003102

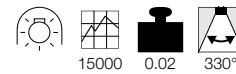
LED QT-DE12
R7S 78mmA+ Range
A++-E

Product details

220-240V ~50/60Hz
Output: 5.5W
Ø: 2.5 cm L: 7.8 cm

Lamp current	0.044A
Output	5.5W
Energy consump./1000h	6kWh
Colour temperature	3000K
Luminous flu	530lm
Colour rendering index	>80

Variant	Item no.
	560332

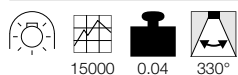
LED QT-DE12
R7S 118mmA+ Range
A++-E

Product details

220-240V ~50/60Hz
Output: 10.5W
Ø: 2.5 cm L: 11.8 cm

Lamp current	0.081A
Output	10.5W
Energy consump./1000h	11kWh
Colour temperature	2700K
Luminous flu	1050lm
Colour rendering index	>80

Variant	Item no.
	560352

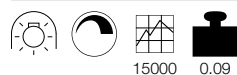
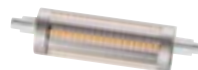
LED QT-DE12
R7S 118mmA++ Range
A++-E

Product details

220-240V ~50/60Hz
Output: 14W
Ø: 2.9 cm L: 11.8 cm
Dimmable: L, C

Lamp current	0.075A
Output	14W
Energy consump./1000h	14kWh
Colour temperature	3000K
Luminous flu	2000lm
Colour rendering index	>80

Variant	Item no.
	1002135



LED QR51
GU5.3

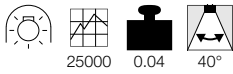

Product details

12V ~50Hz
Output: 3.8W
Ø: 5 cm H: 4.7 cm

Note

Only operate with a conventional transformer.

Lamp current	0.52A
Output	3.8W
Energy consump./1000h	5kWh
Luminous flu	225lm
Max. luminous intensity	500cd
Colour rendering index	>80

Variant	Item no.
2700K	551242
3000K	551243

LED QR51
GU5.3



Product details

12V AC
Output: 5.5W
Ø: 5 cm H: 4.5 cm

Note

Only operate with a conventional transformer.

Lamp current	0.63A
Output	5.5W
Energy consump./1000h	7kWh
Max. luminous intensity	1000cd
Colour rendering index	>80

Variant	Item no.
2700K 450lm	1001574
3000K 460lm	1001575

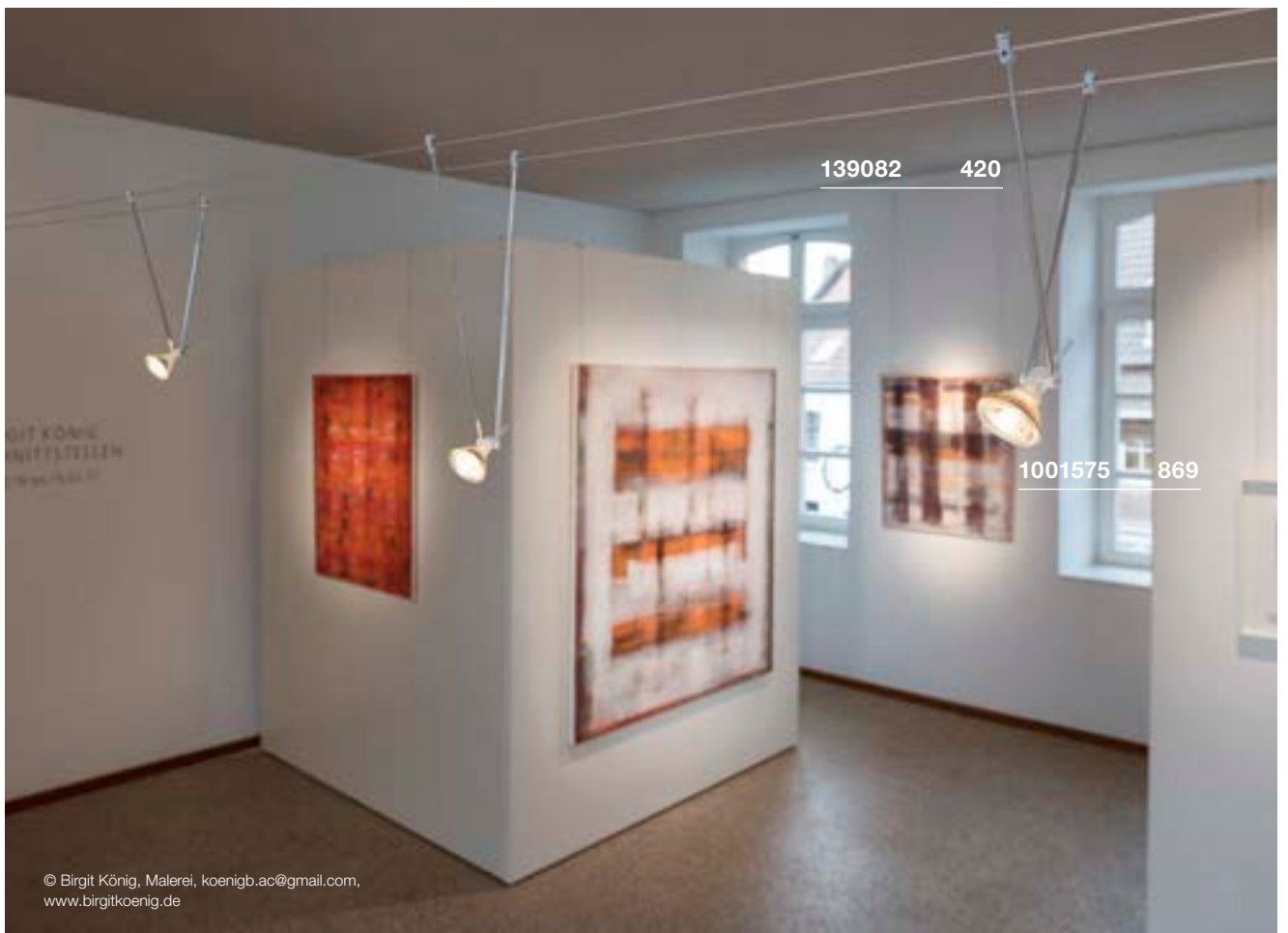

© Birgit König, Malerei, koenigb.ac@gmail.com,
www.birgitkoenig.de

LED T32 FILAMENT
GU10

A+ Range A++-E

NEW



20000 0.06 38°

Product details

220-240V ~50/60Hz
Output: 4W
Ø: 3.2 cm L: 10 cm
Dimmable: C

Lamp current	0.02A
Output	4W
Energy consump./1000h	4kWh
Colour temperature	2600K
Luminous flu	260lm
Max. luminous intensity	700cd
Colour rendering index	>90

Variant	Item no.
	1003101

LED QPAR51
GU10, SLV VALETO®

A+ Range A++-E

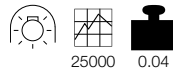

25000 0.04

Product details

220-240V ~50/60Hz
Ø: 5 cm L: 5.4 cm

Note

Can be remote controlled and dimmed using SLV VALETO® CCT/RGBW remote control [1002994] or Gateway [1002411]

Energy consump./1000h	6kWh
Luminous flu	350lm
Colour rendering index	>80

Variant	Item no.
Tunable white 2700-6500K	
5.1W 48°	1001918
RGBW 5.6W 60°	1001919

LED QPAR51
GU10

A+ Range A++-E



25000 0.04 36°

Product details

220-240V ~50/60Hz
Output: 3.7W
Ø: 5 cm H: 5.4 cm
Dimmable: L, C

Note

Particularly suitable for outdoor fittings

Lamp current	0.02A
Output	3.7W
Energy consump./1000h	4kWh
Colour temperature	2700K
Luminous flu	260lm
Max. luminous intensity	500cd
Colour rendering index	>90

Variant	Item no.
	560122

LED QPAR51
GU10

A+ Range A++-E

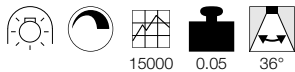

15000 0.05 36°

Product details

220-240V ~50/60Hz
Output: 7.2W
Ø: 5 cm H: 5.7 cm
Dimmable: L, C

Lamp current	0.036A
Output	7.2W
Energy consump./1000h	8kWh
Colour temperature	2700K
Luminous flu	520lm
Max. luminous intensity	1000cd
Colour rendering index	>80

Variant	Item no.
silver	560542
white	560552
black	1001560

LED QPAR51
GU10

A+ Range A++-E

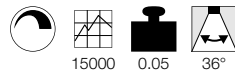

15000 0.05 36°

Product details

220-240V ~50/60Hz
Output: 7.2W
Ø: 5 cm H: 5.4 cm
Dimmable: L, C

Lamp current	0.036A
Output	7.2W
Energy consump./1000h	8kWh
Colour temperature	3000K
Luminous flu	520lm
Max. luminous intensity	1000cd
Colour rendering index	>80

Variant	Item no.
silver	1001561
white	1001562
black	1001563

LED QPAR51
GU10

A+ Range A++-E

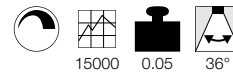

15000 0.05 36°

Product details

220-240V ~50/60Hz
Output: 7.2W
Ø: 5 cm H: 5.4 cm
Dimmable: L, C

Lamp current	0.036A
Output	7.2W
Energy consump./1000h	8kWh
Colour temperature	4000K
Luminous flu	540lm
Max. luminous intensity	1035cd
Colour rendering index	>80

Variant	Item no.
silver	1001564
white	1001565
black	1001566



LED QPAR51
GU10

A+ Range A++-E

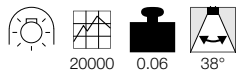

Product details

220-240V ~50/60Hz
Output: 5.5W
Ø: 5 cm H: 5.5 cm
Dimmable: Switch

Lamp current	0.038A
Output	5.5W
Energy consump./1000h	6kWh
Colour temperature	2700K
Luminous flu	400lm
Max. luminous intensity	700cd
Colour rendering index	>80

Variant	Item no.
	1001030

LED QPAR51
GU10

A+ Range A++-E

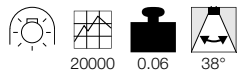

Product details

220-240V ~50/60Hz
Output: 5.5W
Ø: 5 cm H: 5.2 cm
Dimmable: Switch

Note

3 stages, dimmable with normal wall switch.
The lamp dims in stages by switching it off an on again.

Lamp current	0.038A
Output	5.5W
Energy consump./1000h	6kWh
Colour temperature	3000K
Luminous flu	440lm
Max. luminous intensity	770cd
Colour rendering index	>80

Variant	Item no.
	551902

LED QPAR51
GU10

A+ Range A++-E

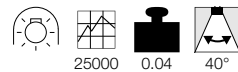

Product details

220-240V ~50/60Hz
Output: 4.3W
Ø: 5 cm H: 5.4 cm

Lamp current	0.039A
Output	4.3W
Energy consump./1000h	5kWh
Luminous flu	245lm
Max. luminous intensity	530cd
Colour rendering index	>80

Variant	Item no.
2700K	551252
3000K	551253



LED QPAR111
GU10A+ Range
A++-E

NEW



40000 0.19 55°

Product details

220-240V ~50/60Hz
Output: 13W
Ø: 11 cm L: 7 cm
Dimmable: C

Lamp current	0.052A
Output	13W
Energy consump./1000h	13kWh
Colour rendering index	>90

Variant	Item no.
2700K 840lm	1003094
4000K 950lm	1003095

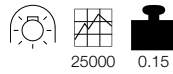
LED QPAR111
GU10, CCT, SLV VALETO®A+ Range
A++-E

25000 0.15

Product details

220-240V ~50/60Hz
Output: 9W
Ø: 11.1 cm H: 7 cm

Note

Can be remote controlled and dimmed using SLV VALETO® CCT/RGBW remote control [1002994] or Gateway [1002411]

Lamp current	0.048A
Output	9W
Energy consump./1000h	9kWh
Colour temperature	2700K-6500K
Luminous flu	800lm
Colour rendering index	>80

Variant	Item no.
3300cd 25°	1001920
1900cd 40°	1001921

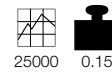
LED QPAR111
GU10, RGBW, SLV VALETO®A+ Range
A++-E

25000 0.15

Product details

220-240V ~50/60Hz
Output: 9W
Ø: 11.1 cm H: 7 cm

Note

Can be remote controlled and dimmed using SLV VALETO® CCT/RGBW remote control [1002994] or Gateway [1002411]

Lamp current	0.048A
Output	9W
Energy consump./1000h	9kWh
Colour temperature	RGBW
Luminous flu	800lm
Max. luminous intensity	3700cd
Colour rendering index	>80

Variant	Item no.
25°	1001922
40°	1001923

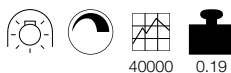
LED QPAR111
GU10A+ Range
A++-E

40000 0.19

Product details

230V ~50Hz
Output: 13W
Ø: 11.1 cm H: 7.1 cm
Dimmable: C

Lamp current	0.052A
Output	13W
Energy consump./1000h	13kWh
Colour temperature	2700K
Colour rendering index	>80

Variant	Item no.
1100lm 1670cd 30°	1001242
1000lm 140°	1001244

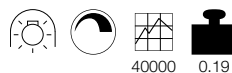
LED QPAR111
GU10A+ Range
A++-E

40000 0.19

Product details

230V ~50Hz
Output: 13W
Ø: 11.1 cm H: 7.1 cm
Dimmable: C

Lamp current	0.052A
Output	13W
Colour temperature	4000K
Colour rendering index	>80

Variant	Item no.
13kWh 1300lm 1950cd 30°	1001243
30kWh 1100lm 140°	1001245

LED QPAR111
GU10A+ Range
A++-E

NEW

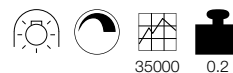

35000 0.2

Product details

220-240V ~50/60Hz
Output: 13W
Ø: 11 cm H: 7.1 cm
Dimmable: C

Lamp current	0.052A
Output	13W
Energy consump./1000h	13kWh
Colour temperature	4000K
Colour rendering index	>90

Variant	Item no.
1100lm 30°	1003087
1000lm 140°	1003088

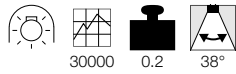
LED QPAR111
GU10A+ Range
A++-E

Product details

220-240V ~50/60Hz
Output: 6.5W
Ø: 11 cm H: 7 cm

Lamp current	0.046A
Output	6.5W
Energy consump./1000h	7kWh
Colour temperature	2700K
Luminous flu	390lm
Max. luminous intensity	785cd
Colour rendering index	>80

Variant	Item no.
	551882

LED QPAR111
GU10A+ Range
A++-E

Product details

220-240V ~50/60Hz
Output: 6.5W
Ø: 11.1 cm H: 7 cm
Dimmable: Switch

Note

3 stages, dimmable with normal wall switch.
The lamp dims in stages by switching it off an on again.

Lamp current	0.048A
Output	6.5W
Energy consump./1000h	7kWh
Colour rendering index	>80

Variant	Item no.
2700K 400lm 720cd	1000684
3000K 420lm 750cd	551912

LED QPAR111
GU10A+ Range
A++-E

Product details

220-240V ~50/60Hz
Output: 10W
Ø: 11.1 cm H: 7 cm
Dimmable: Switch

Note

3 stages, dimmable with normal wall switch.
The lamp dims in stages by switching it off an on again.

Lamp current	0.82A
Output	10W
Energy consump./1000h	10kWh
Colour rendering index	>80

Variant	Item no.
2700K 540lm 890cd	1001028
3000K 630lm 1040cd	1001029

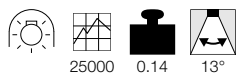
LED QPAR111
GU10A+ Range
A++-E

Product details

220-240V ~50/60Hz
Ø: 11.1 cm H: 7.3 cm

Energy consump./1000h	8kWh
Luminous flu	730lm
Max. luminous intensity	5600cd
Colour rendering index	>80

Variant	Item no.
2700K 7.3W 0.069A	1000939
3000K 7W 0.04A	1001568
4000K 7.3W 0.069A	1000940

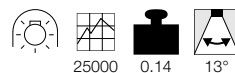
LED QPAR111
GU10A+ Range
A++-E

Product details

220-240V ~50/60Hz
Ø: 11.1 cm H: 7.3 cm

Lamp current	0.04A
Output	7W
Energy consump./1000h	8kWh
Luminous flu	730lm
Max. luminous intensity	5600cd
Colour rendering index	>80

Variant	Item no.
2700K 7.3W 0.069A	1000941
3000K 7W 0.04A	1001569
4000K 7.3W 0.069A	1000942

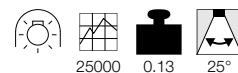
LED QPAR111
GU10A+ Range
A++-E

Product details

220-240V ~50/60Hz
Output: 7.9W
Ø: 11.1 cm

Energy consump./1000h	8kWh
Colour rendering index	>80

Variant	Item no.
2700K 730lm 7.9W 0.039A 1900cd	
H: 7cm	560702
3000K 730lm 7W 0.04A 1800cd	
H: 7.3 cm	1001570
4000K 760lm 7.9W 0.04A 1800cd	
H: 7cm	560704

LED QPAR111
GU10

A+ Range A++-E



Product details

220-240V ~50/60Hz
Ø: 11.1 cm H: 7 cm

Energy consump./1000h 8kWh
Colour rendering index >80

Variant	Item no.
2700K 730lm 7.9W 0.039A	
1800cd 0.13 kg	560712
3000K 730lm 7W 0.04A	
1800cd 0.14 kg	1001571
4000K 760lm 7.9W 0.039A	
1900cd 0.12 kg	560714

LED QPAR111
GU10

A+ Range A++-E

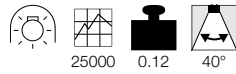

Product details

220-240V ~50/60Hz
Ø: 11.1 cm

Energy consump./1000h 8kWh
Colour rendering index >80

Variant	Item no.
2700K 730lm 7.9W 0.039A 1800cd	
0.13 kg H: 7 cm	560722
3000K 730lm 7W 0.04A 870cd	
0.14 kg H: 7.3 cm	1001572
4000K 760lm 7.9W 0.039A 920cd	
0.12 kg H: 7 cm	560724

LED QPAR111
GU10

A+ Range A++-E

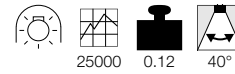

Product details

220-240V ~50/60Hz
Output: 7.9W
Ø: 11.1 cm H: 7 cm

Energy consump./1000h 8kWh
Colour rendering index >80

Variant	Item no.
2700K 730lm 7.9W 0.039A 870cd	
0.12 kg H: 7 cm	560732
3000K 730lm 7W 0.04A 870cd	
0.14 kg H: 7.3 cm	1001573
4000K 760lm 7.9W 0.039A 920cd	
0.12 kg H: 7 cm	560734

LED QR111
G53

A Range A++-E

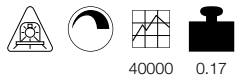

Product details

12V AC
Output: 15W
Ø: 11.1 cm H: 6.2 cm

Lamp current 1.8A
Output 15W
Energy consump./1000h 17kWh
Colour temperature 2700K
Colour rendering index >90

Variant	Item no.
760lm 3900cd 24°	560231
750lm 1400cd 40°	560232

LED QR111
G53

A Range A++-E

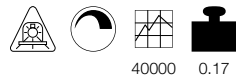

Product details

12V AC
Output: 15W
Ø: 11.1 cm H: 6.2 cm

Lamp current 1.8A
Output 15W
Energy consump./1000h 17kWh
Colour temperature 3000K
Colour rendering index >90

Variant	Item no.
770lm 4000cd 24°	560233
760lm 1450cd 40°	560234

LED QR111
G53

A Range A++-E

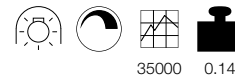

Product details

12V AC
Output: 19.5W
Ø: 11 cm H: 6.1 cm

Lamp current 1.85A
Output 19.5W
Energy consump./1000h 21kWh
Colour temperature 2700K
Max. luminous intensity 1625cd
Colour rendering index >80

Variant	Item no.
1070lm 1625cd 30°	551402
900lm 400cd 140°	551412

LED QR111
G53A → Range
A++-E

35000 0.14

Product details

12V ~50Hz
Output: 15W
Ø: 11 cm H: 6 cm

Note

Only operate with a conventional transformer.

Lamp current	1.75A
Output	15W
Energy consump./1000h	16kWh
Colour temperature	2700K
Colour rendering index	>80

Variant	Item no.
810lm 1230cd 30°	551602
680lm 300cd 140°	551612

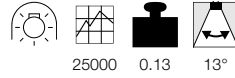
LED QR111
G53A+ → Range
A++-E

25000 0.13 13°

Product details

12V ~50Hz
Output: 9W
Ø: 11.1 cm H: 5.7 cm

Note

Only operate with a conventional transformer.

Lamp current	1.29A
Output	9W
Energy consump./1000h	10kWh
Luminous flu	800lm
Max. luminous intensity	5600cd
Colour rendering index	>80

Variant	Item no.
2700K	560622
4000K	560624

LED QR111
G53A → Range
A++-E

25000 0.13 40°

Product details

12V ~50Hz
Output: 9W
Ø: 11.1 cm H: 5.4 cm

Note

Only operate with a conventional transformer.

Lamp current	1.29A
Output	9W
Energy consump./1000h	10kWh
Luminous flu	800lm
Colour rendering index	>80

Variant	Item no.
2700K 1000cd	560662

LED C35
E14A++ → Range
A++-E

15000 0.03 280°

Product details

220-240V ~50/60Hz
Output: 4.5W
Ø: 3.5 cm H: 12.1 cm
Dimmable: L, C

Lamp current	0.022A
Output	4.5W
Energy consump./1000h	5kWh
Colour temperature	2700K
Luminous flu	490lm
Colour rendering index	>80

Variant	Item no.
	1002128

LED C35
E14A+ → Range
A++-E

15000 0.04 280°

Product details

220-240V ~50/60Hz
Output: 6.5W
Ø: 3.8 cm H: 11 cm
Dimmable: L, C

Lamp current	0.033A
Output	6.5W
Energy consump./1000h	7kWh
Colour temperature	3000K
Luminous flu	480lm
Colour rendering index	>80

Variant	Item no.
	560372

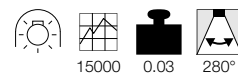
LED C35
E14A+ → Range
A++-E

15000 0.03 280°

Product details

220-240V ~50/60Hz
Output: 4W
Ø: 3.7 cm H: 11.3 cm

Lamp current	0.035A
Output	4W
Energy consump./1000h	4kWh
Colour temperature	2700K
Luminous flu	250lm
Colour rendering index	>80

Variant	Item no.
	560222

LED A60
E27, CCT

A+ Range A++-E



Product details

220-240V ~50/60Hz
Output: 9W
Ø: 6 cm H: 12 cm

Note

Can be remote controlled and dimmed using SLV VALETO® CCT/RGBW remote control [1002994] or Gateway [1002411]

Lamp current	0.052A
Output	9W
Energy consump./1000h	9kWh
Colour temperature	2700K-6500K
Luminous flu	806lm
Colour rendering index	>80

Variant	Item no.
	1001916

LED A60
E27, RGBW

A+ Range A++-E



Product details

220-240V ~50/60Hz
Output: 9.5W
Ø: 6 cm H: 12 cm

Note

Can be remote controlled and dimmed using SLV VALETO® CCT/RGBW remote control [1002994] or Gateway [1002411]

Lamp current	0.054A
Output	9.5W
Energy consump./1000h	10kWh
Colour temperature	RGBW
Luminous flu	806lm
Colour rendering index	>80

Variant	Item no.
	1001917

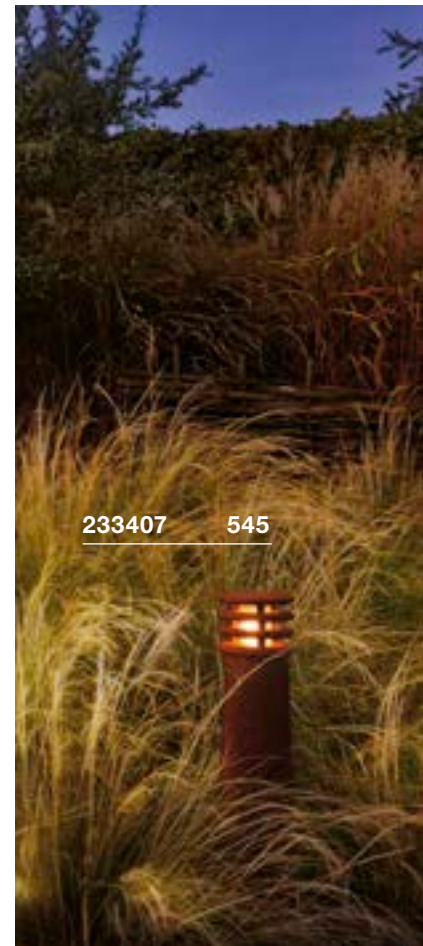

233407 545

LED A60
E27

A+ Range A++-E

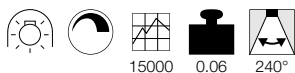

Product details

220-240V ~50/60Hz
Output: 9.1W
Ø: 6 cm H: 11 cm
Dimmable: L, C

Lamp current	0.043A
Output	9.1W
Energy consump./1000h	10kWh
Colour temperature	2700K
Luminous flu	760lm
Colour rendering index	>80

Variant	Item no.
	560402

LED A60
E27

A+ Range A++-E



Product details

220-240V ~50/60Hz
Output: 14.5W
Ø: 6 cm H: 12.2 cm
Dimmable: L, C

Lamp current	0.064A
Output	14.5W
Energy consump./1000h	15kWh
Colour temperature	2700K
Luminous flu	1521lm
Colour rendering index	>80

Variant	Item no.
	560422

LED T45
E27

A+ Range A++-E

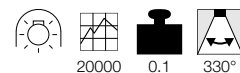

Product details

230V ~50Hz
Output: 4.7W
Ø: 4.5 cm H: 13.9 cm

Lamp current	0.037A
Output	4.7W
Energy consump./1000h	5kWh
Colour temperature	3000K
Luminous flu	380lm
Colour rendering index	>80

Variant	Item no.
	551532



LED T38 E27

A+ Range A++-E

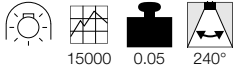

Product details

100-240V ~50/60Hz
Output: 9W
Ø: 3.8 cm H: 11.5 cm

Lamp current	0.046A
Output	9W
Energy consump./1000h	10kWh
Colour rendering index	>80

Variant	Item no.
3000K 810lm	1001031
4000K 850lm	1002827

LED T45 E27

A+ Range A++-E

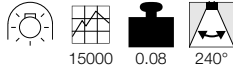

Product details

100-240V ~50/60Hz
Output: 12W
Ø: 4.5 cm H: 13.6 cm

Lamp current	0.052A
Output	12W
Energy consump./1000h	12kWh
Colour temperature	3000K
Luminous flu	1060lm
Colour rendering index	>80

Variant	Item no.
	1001032

LED T45 E27

A+ Range A++-E

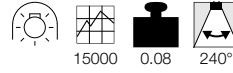

Product details

100-240V ~50/60Hz
Output: 15W
Ø: 4.5 cm H: 13.6 cm

Lamp current	0.063A
Output	15W
Energy consump./1000h	15kWh
Colour rendering index	>80

Variant	Item no.
3000K 1521lm	1001033
4000K 1600lm	1002828

LED A60 E27

A+ Range A++-E

NEW

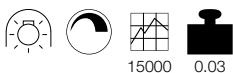

Product details

220-240V ~50/60Hz
Output: 7W
Ø: 6 cm L: 10.5 cm
Dimmable: C, L

Lamp current	0.032A
Output	7W
Energy consump./1000h	7kWh
Colour temperature	2700K
Luminous flu	810lm
Colour rendering index	>80

Variant	Item no.
	1003090

LED FRISBEE E27

A+ Range A++-E

NEW

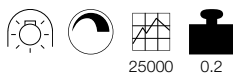

Product details

220-240V ~50/60Hz
Output: 10.5W
Ø: 19.2 cm L: 11.8 cm
Dimmable: C

Lamp current	0.055A
Output	10.5W
Energy consump./1000h	10.5kWh
Colour temperature	2700K
Luminous flu	1000lm
Colour rendering index	>80

Variant	Item no.
	1003093

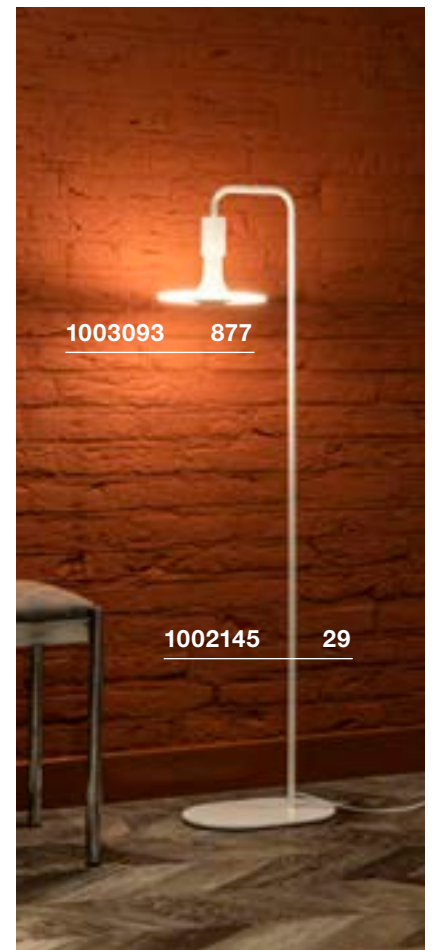

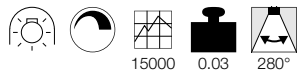
LED A60
E27A++ Range
A++-E

Product details

220-240V ~50/60Hz
Output: 4.5W
Ø: 6 cm H: 10.5 cm
Dimmable: L, C

Lamp current	0.022A
Output	4.5W
Energy consump./1000h	5kWh
Colour temperature	2700K
Luminous flu	530lm
Colour rendering index	>80

Variant	Item no.
	1002123

LED A60
E27A++ Range
A++-E

NEW

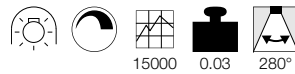

Product details

220-240V ~50/60Hz
Output: 7W
Ø: 6 cm H: 10.5 cm
Dimmable: L, C

Lamp current	0.031A
Output	7W
Energy consump./1000h	7kWh
Colour temperature	2700K
Luminous flu	790lm
Colour rendering index	>80

Variant	Item no.
	1002124

LED A60
E27A++ Range
A++-E

SWITCH DIM



Product details

220-240V ~50/60Hz
Output: 7W
Ø: 6 cm H: 10.5 cm
Dimmable: Switch

Lamp current	0.053A
Output	7W
Energy consump./1000h	7kWh
Colour temperature	2700K
Luminous flu	790lm
Colour rendering index	>80

Variant	Item no.
	1002127

LED A60
E27A++ Range
A++-E

DIM TO WARM

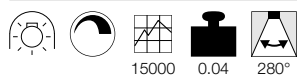

Product details

220-240V ~50/60Hz
Output: 4.5W
Ø: 6 cm H: 11.4 cm
Dimmable: L, C

Lamp current	0.022A
Output	4.5W
Energy consump./1000h	5kWh
Colour temperature	2200-2700K
Luminous flu	500lm
Colour rendering index	>80

Variant	Item no.
	1002125

LED A60
E27A++ Range
A++-E

DIM TO WARM

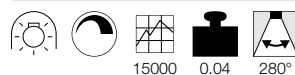

Product details

220-240V ~50/60Hz
Output: 7W
Ø: 6 cm H: 11.4 cm
Dimmable: L, C

Lamp current	0.031A
Output	7W
Energy consump./1000h	7kWh
Colour temperature	2200-2700K
Luminous flu	830lm
Colour rendering index	>80

Variant	Item no.
	1002126

LED A60
E27A+ Range
A++-E

NEW



Product details

220-240V ~50/60Hz
Output: 15W
Ø: 9 cm L: 23 cm
Dimmable: C

Lamp current	0.09A
Output	15W
Energy consump./1000h	15kWh
Colour temperature	2700K
Luminous flu	1600lm
Colour rendering index	>90

Variant	Item no.
	1003097



LED ST58
E27

A+ Range A++-E



Product details

220-240V ~50/60Hz
Output: 7.1W
Ø: 5.8 cm H: 12.8 cm
Dimmable: L, C

Lamp current	0.035A
Output	7.1W
Energy consump./1000h	8kWh
Colour temperature	2700K
Luminous flu	806lm
Colour rendering index	>80

Variant	Item no.
	1001756

LED ST64
E27

A+ Range A++-E



Product details

220-240V ~50/60Hz
Output: 5W
Ø: 6.4 cm H: 14.5 cm

Lamp current	0.043A
Output	5W
Energy consump./1000h	5kWh
Colour temperature	2000K
Luminous flu	500lm
Colour rendering index	>80

Variant	Item no.
	560741

LED T32
E27

A+ Range A++-E

NEW

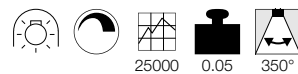

Product details

220-240V ~50/60Hz
Output: 8W
Ø: 3.2 cm H: 18.5 cm

Lamp current	0.03A
Output	8W
Energy consump./1000h	8kWh
Colour temperature	2200K
Luminous flu	250lm
Colour rendering index	>95

Variant	Item no.
	1003100

LED A60
E27, Mirrorhead, chrome

A+ Range A++-E

NEW

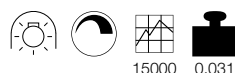

Product details

220-240V ~50/60Hz
Output: 7W
Ø: 6 cm H: 10.5 cm
Dimmable: L, C

Lamp current	0.032A
Output	7W
Energy consump./1000h	7kWh
Colour temperature	2700K
Luminous flu	640lm
Colour rendering index	>80

Variant	Item no.
	1003085

LED A60
E27, Mirrorhead, gold

A+ Range A++-E

NEW



DM TO WARM



Product details

220-240V ~50/60Hz
Output: 4W
Ø: 6 cm L: 10.6 cm
Dimmable: C

Lamp current	0.02A
Output	4W
Energy consump./1000h	4kWh
Colour temperature	2000-2900K
Luminous flu	200lm
Colour rendering index	>90

Variant	Item no.
	1003098

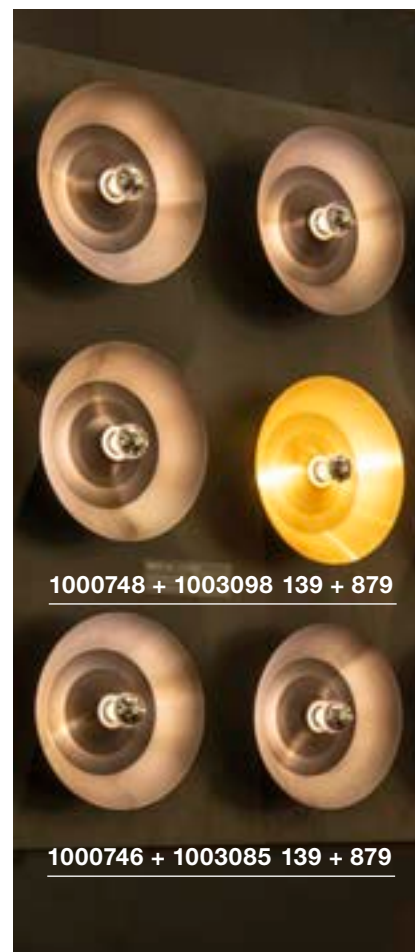

LED G95/G125
E27

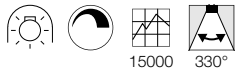

Product details

220-240V ~50/60Hz
Output: 7W
Dimmable: L, C

Lamp current	0.043A
Output	7W
Energy consump./1000h	8kWh
Colour temperature	2700K
Luminous flu	806lm
Colour rendering index	>80

Variant	Item no.
Ø: 9.5 cm H: 13.2 cm 0.06 kg	1001035
Ø: 12.5 cm H: 17.8 cm 0.1 kg	1001038

LED G95/G125
E27, smoked glass



Product details

220-240V ~50/60Hz
Output: 7W
Dimmable: C

Lamp current	0.032A
Output	7W
Energy consump./1000h	7kWh
Colour temperature	2700K
Colour rendering index	>80

Variant	Item no.
360lm Ø: 9.5 cm H: 13.5 cm 0.054 kg	1003091
440lm Ø: 12.4 cm H: 16.8 cm 0.124 kg	1003092

LED G125
E27



Product details

220-240V ~50/60Hz
Output: 7W
Ø: 12.5 cm H: 17.8 cm
Dimmable: L, C

Lamp current	0.043A
Output	7W
Energy consump./1000h	8kWh
Colour temperature	2700K
Luminous flu	630lm
Colour rendering index	>80

Variant	Item no.
	1001357

LED G125
E27, Mirrorhead, gold



Product details

220-240V ~50/60Hz
Output: 8W
Ø: 12.5 cm H: 18 cm

Lamp current	0.04A
Output	8W
Energy consump./1000h	8kWh
Colour temperature	2000-2900K
Luminous flu	400lm
Colour rendering index	>90

Variant	Item no.
	1003099

LED G125
E27, smoked glass

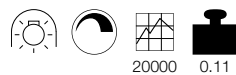

Product details

220-240V ~50/60Hz
Output: 8W
Ø: 12.5 cm H: 18 cm

Lamp current	0.032A
Output	8W
Energy consump./1000h	8kWh
Colour temperature	2000-2900K
Luminous flu	500lm
Colour rendering index	>90

Variant	Item no.
	1003096

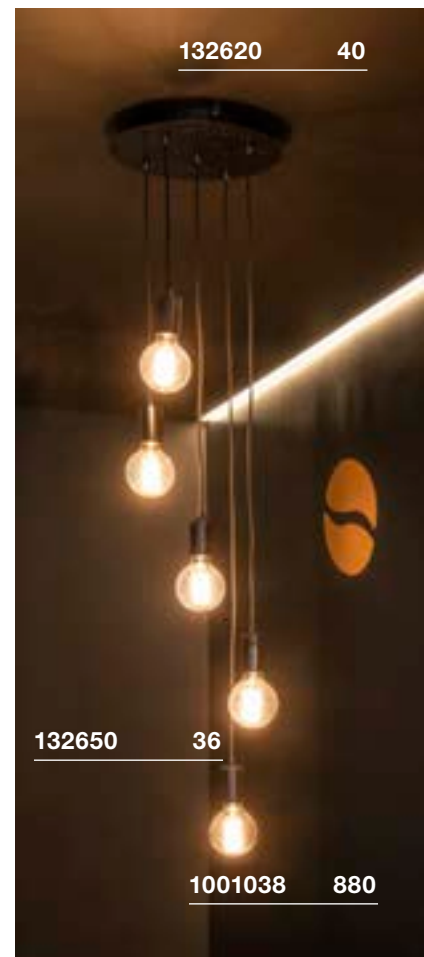



LED PAR30 E27

A+ Range A++-E

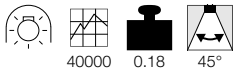

Product details

220-240V ~50/60Hz
Output: 11W
Ø: 9.5 cm H: 11.6 cm

Lamp current	0.051A
Output	11W
Energy consump./1000h	11kWh
Colour temperature	3000K
Luminous flu	900lm
Max. luminous intensity	1300cd
Colour rendering index	>80

Variant	Item no.
	560463

LED PAR38 E27

A+ Range A++-E

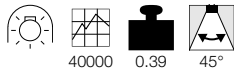

Product details

220-240V ~50/60Hz
Output: 17W
Ø: 12.2 cm H: 13.5 cm

Lamp current	0.079A
Output	17W
Energy consump./1000h	17kWh
Colour temperature	3000K
Luminous flu	1430lm
Max. luminous intensity	1630cd
Colour rendering index	>80

Variant	Item no.
	560473

LED TCR-TSE GX53

A++ Range A++-E

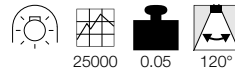

Product details

230V ~50Hz
Output: 3W
Ø: 7.6 cm H: 2.6 cm

Lamp current	0.03A
Output	3W
Energy consump./1000h	3kWh
Colour temperature	3000K
Luminous flu	250lm
Colour rendering index	>80

Variant	Item no.
	551372

LED TCR-TSE GX53

A Range A++-E

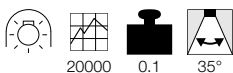

Product details

230V ~50Hz
Output: 4.2W
Ø: 7.5 cm H: 3.5 cm

Lamp current	0.041A
Output	4.2W
Energy consump./1000h	5kWh
Colour temperature	3000K
Luminous flu	200lm
Max. luminous intensity	550cd
Colour rendering index	>80

Variant	Item no.
	550092

LED TCR-TSE GX53

A Range A++-E

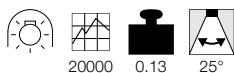

Product details

230V ~50Hz
Output: 7.5W
Ø: 7.6 cm H: 3.5 cm

Lamp current	0.037A
Output	7.5W
Energy consump./1000h	8kWh
Colour temperature	3000K
Luminous flu	450lm
Max. luminous intensity	1235cd
Colour rendering index	>80

Variant	Item no.
	550082

LED TCR-TSE GX53

A+ Range A++-E

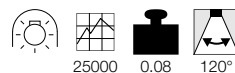

Product details

220-240V ~50/60Hz
Output: 8.2W
Ø: 7.5 cm H: 2.9 cm

Lamp current	0.062A
Output	8.2W
Energy consump./1000h	9kWh
Colour rendering index	>80

Variant	Item no.
3000K 600lm	550073
4000K 620lm	550074

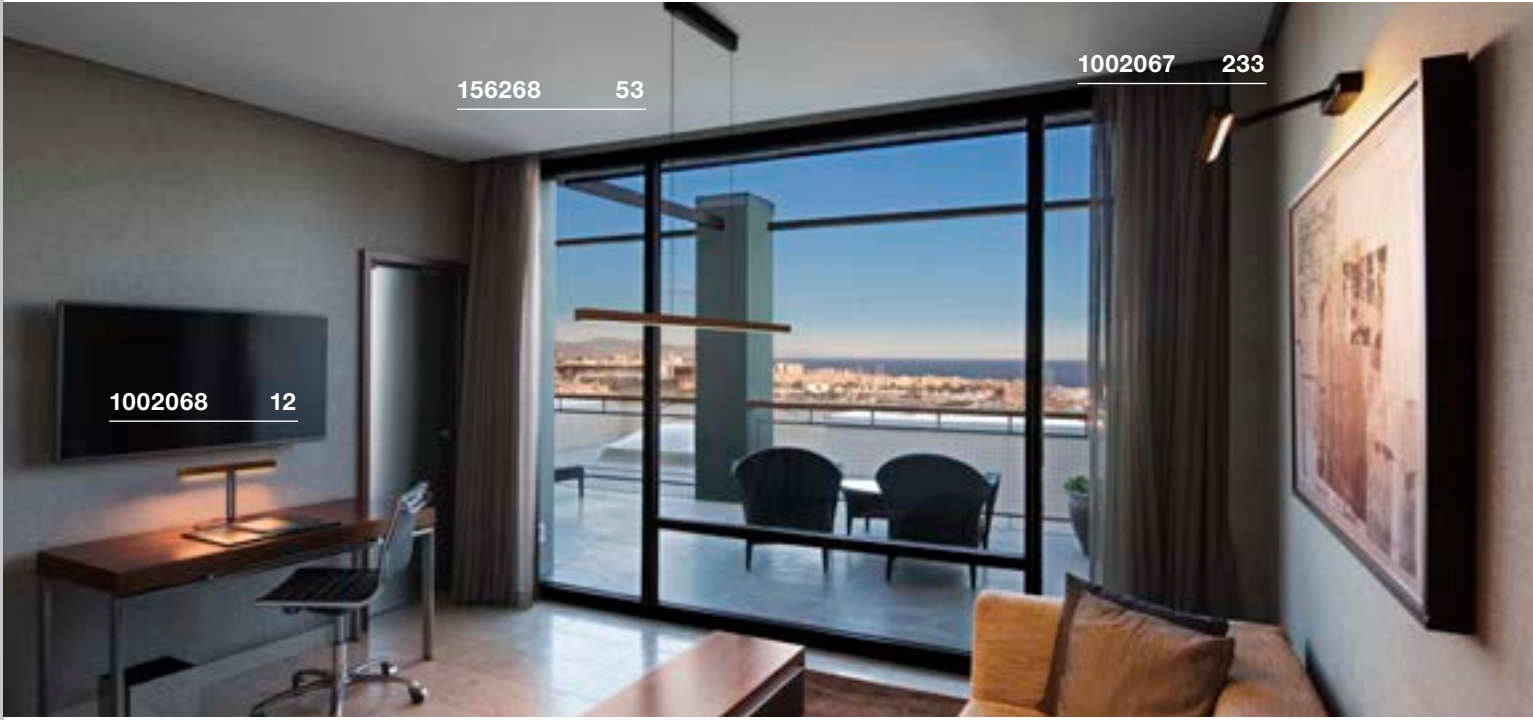

IT'S A FAMILY AFFAIR: OUR SLV LUMINAIRE FAMILIES.

Particularly when visual continuity is required, our range of luminaires is ideal for designing different rooms or room situations in a uniform way, yet still remain versatile.

ABRIDOR

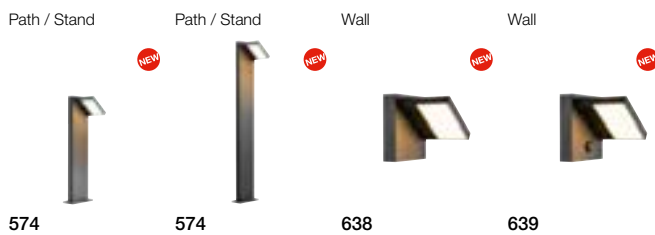

ACCANTO



ADEGAN MANILA





AIXLIGHT®

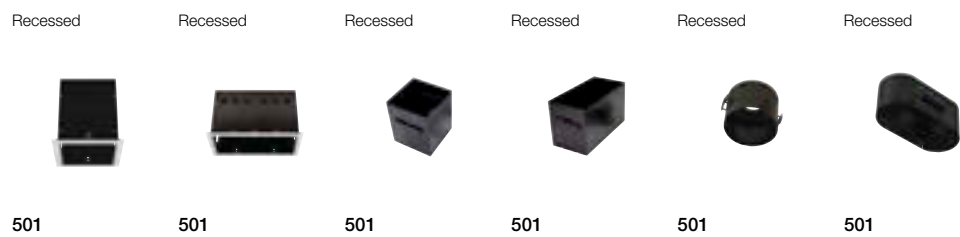
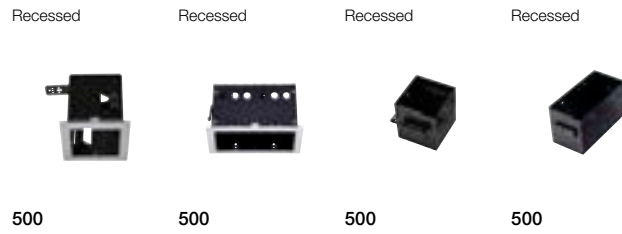

AIXLIGHT® R2

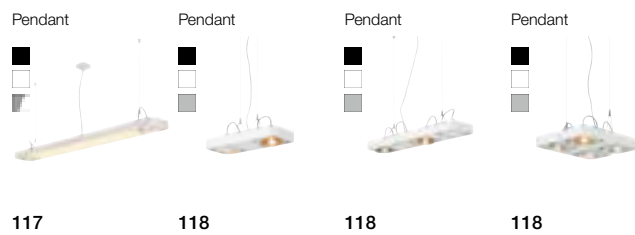

ALMINO

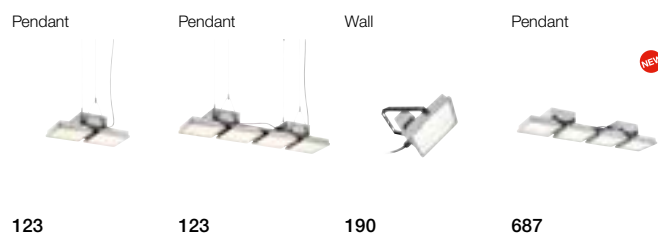

ALTRA DICE

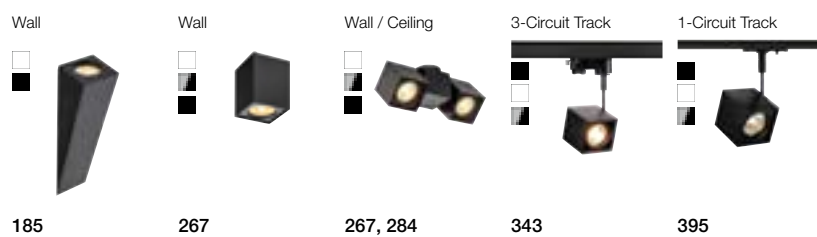

ANELA



APONI





ASTINA

Pendant	Wall	Ceiling	Wall	Wall	Wall
069	177	264	654	655	655

AVO

Wall / Ceiling	Wall / Ceiling	Wall / Ceiling	Wall / Ceiling	3-Circuit Track	1-Circuit Track
299	299	299	299	343	387

BATO

Pendant	Pendant	Pendant	Pendant
058	058	058	059
Wall	Wall	Ceiling	Ceiling
139	139	238	238

BENDO



Path / Stand	Path / Stand	Wall
572	572	636

BIG NAILS

Path / Stand	Path / Stand	Path / Stand	Wall
551	552	552	619

BIG THEO

Wall	Wall	Ceiling
650	665	678



BIG THEO LED

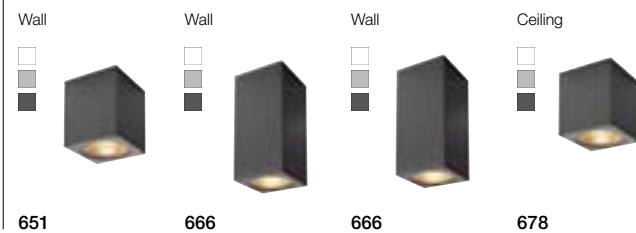

BILAS

Design:
Vincent de Smedt

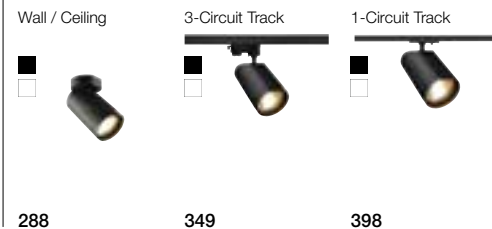

BIMA

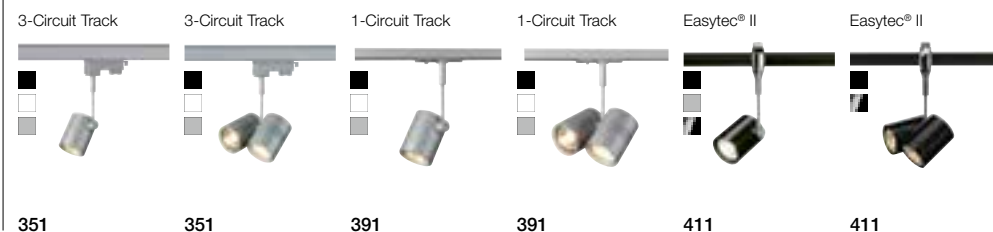

BISHADE

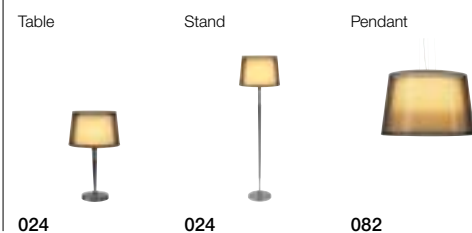

BRENDA

Design:
Johannes Tomm



ENOLA B

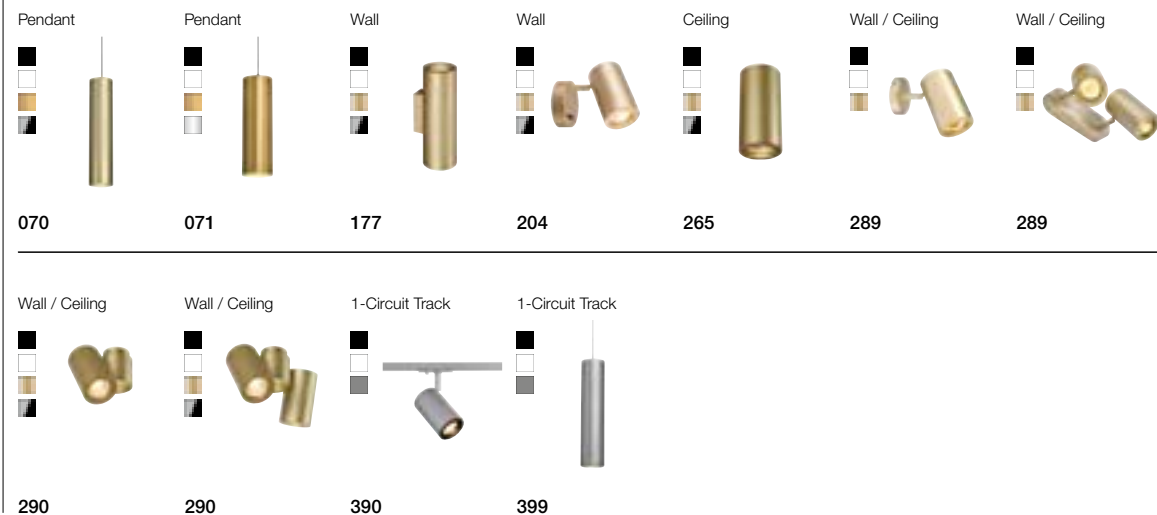



ENOLA C

Ceiling 266	Ceiling 266	3-Circuit Track 346	1-Circuit Track 397	Path / Stand 577	Wall 628	Wall 656
Wall / Ceiling 675	Wall / Ceiling 675	ESKINA		Path / Stand 577	Wall 670	Wall 689

EURO SPOT

3-Circuit Track 334	3-Circuit Track 334	3-Circuit Track 335	3-Circuit Track 360	3-Circuit Track 360	
3-Circuit Track 361	3-Circuit Track 361	3-Circuit Track 361	1-Circuit Track 392	1-Circuit Track 392	1-Circuit Track 393

FENDA
MIX & MATCH

Table 018	Stand 018	Table 020	Stand 020	Stand 022	
Pendant 044	Wall 148	Wall 192	Wall 193	Ceiling 234	
Shades 018, 020, 046	Shades 019, 021, 022, 047, 235	Shades 022, 044	Shades 044	Shades 148	Shades 192



FITU
MIX & MATCH

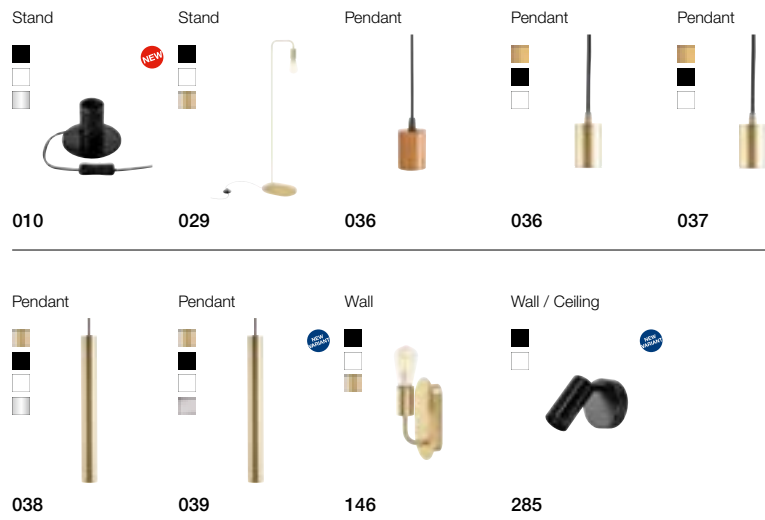

FLATT



FORCHINI



F-POL



GLOO PURE

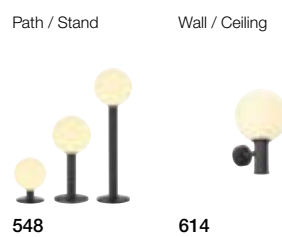



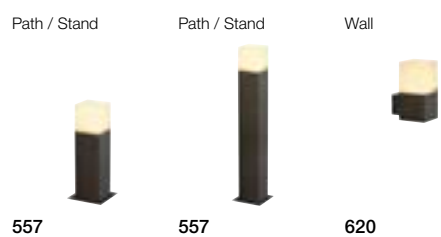

















GRAFIT





HELIA

Pendant  072	Pendant  072	Pendant  073	Pendant  073	Wall / Ceiling  292	Wall / Ceiling  292
3-Circuit Track  346	1-Circuit Track  397	Easytec® II  410	Recessed  447		
Path / Stand  580	Path / Stand  580	Path / Stand  581	Path / Stand  583	Path / Stand  583	
Spot  599	Spot  599	Wall  629	Wall  653	Wall  691	Wall  691

IPERI

Path / Stand  575	Wall  642				
--	--	--	--	--	--

KALU LED

Wall / Ceiling  306	Wall / Ceiling  306	Wall / Ceiling  306	Wall / Ceiling  307	Wall / Ceiling  307	Wall / Ceiling  307
3-Circuit Track  359	3-Circuit Track  359	1-Circuit Track  395			



KALU
QPAR111

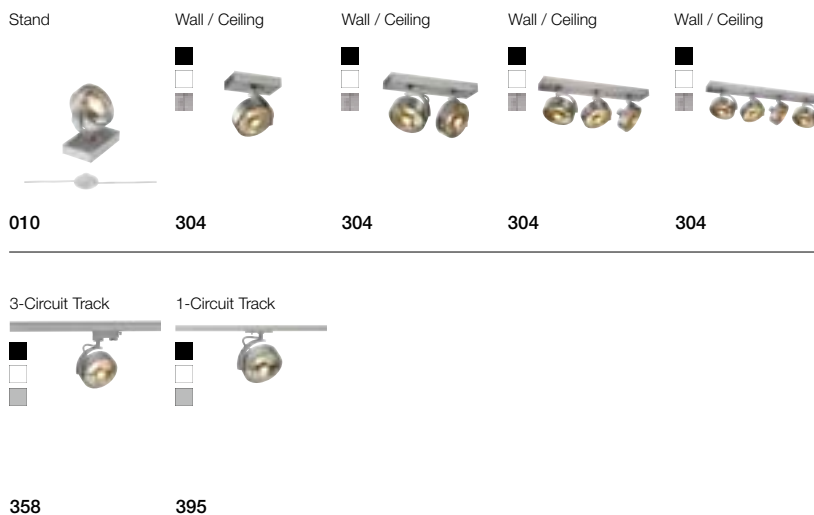

KARPO

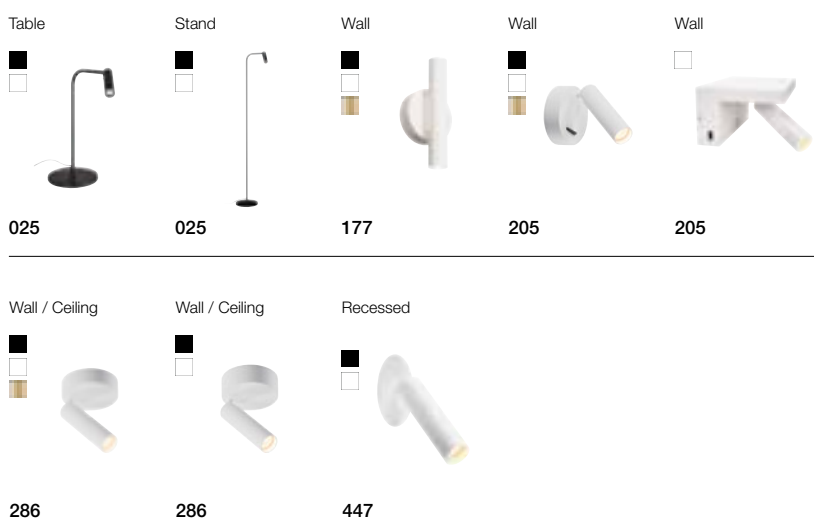

LASSON

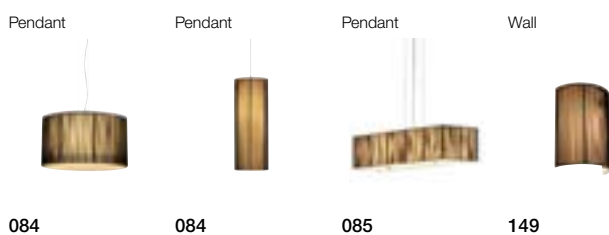

LED SAIL

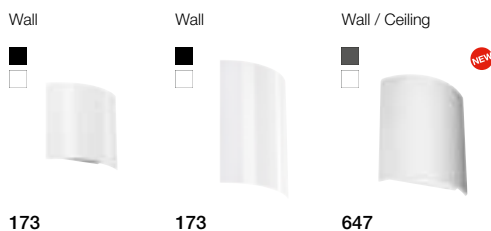

LENITO

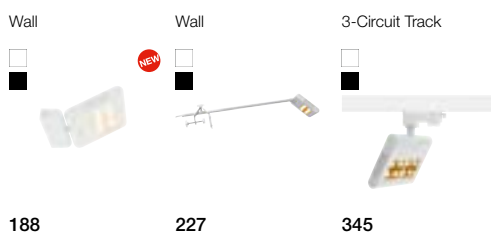



LIGHT EYE 150

Pendant	3-Circuit Track	3-Circuit Track	1-Circuit Track	Easytec® II	Easytec® II
050	344	363	399	413	414

LIGHT EYE 90

Pendant	Wall / Ceiling	Wall / Ceiling	1-Circuit Track	Easytec® II
050	291	291	388	413

LIGHT PIPE

Pendant	Pendant	Path / Stand	Path / Stand	Path / Stand
075	075	028, 550	028, 550	028, 550

LISENNE

Pendant	Wall	Table	Path / Stand	Path / Stand	Ceiling
076	143	541	546	546	673

LOGS

Wall	Wall	Wall	Wall	Path / Stand	Path / Stand	Wall
156	156	157	157	558	558	664

LYNAH

Pendant	Wall
119	184

MAGANDA













Table	Wall
012	210





MALU

Stand	Wall / Ceiling	Wall / Ceiling
576	644	679

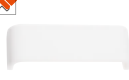





























MANA











Wall 	Shade 	Shade 	Wall 	Shade 	Shade 	Shade 
						
150	151	151	152	153, 199	153, 199	153, 199





Wall 	Wall 	NEW
		
198	660	

MEDO LED

Pendant/ceiling 	Pendant/ceiling 	Pendant/ceiling 	Pendant/ceiling 	Pendant/ceiling 	Pendant/ceiling 	Pendant/ceiling 
						
090, 246	091, 247	092, 248	092, 248	092, 248	093, 249	094, 250, 321

Pendant/ceiling 	Pendant/ceiling 	Pendant/ceiling 	Pendant/ceiling 	Pendant/ceiling 	Pendant/ceiling 	Pendant/ceiling 
						
095, 251, 321	095, 251, 321	095, 251	096, 252	096, 252	096, 252	097, 253

Pendant/ceiling 	Pendant/ceiling 	Pendant 	Pendant 	Pendant 
				
098, 254	099, 255	100	100	101

Recessed 	Recessed 
	
518, 519	520, 521

MERADO FLOOD

Wall 	3-Circuit Track 
	
189	345

MOLAT

Pendant 	Path / Stand 	Wall 	Ceiling 
			
532	550	614	672



MYRA

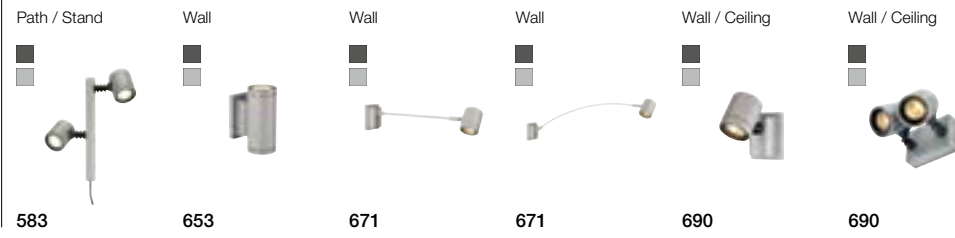

NAUTILUS

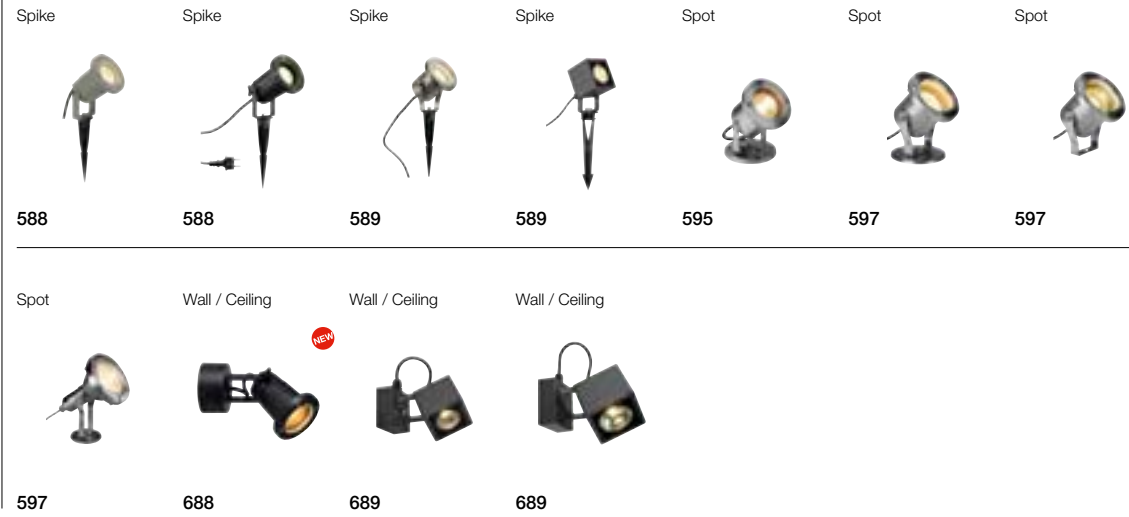

NOBLO

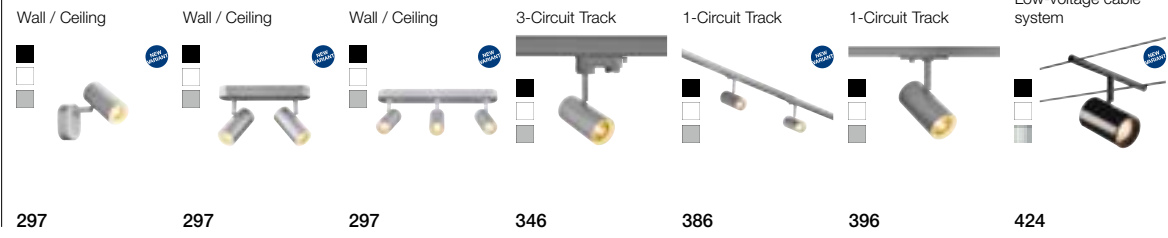

OCCULDAS

Design: David Morgan



ONE

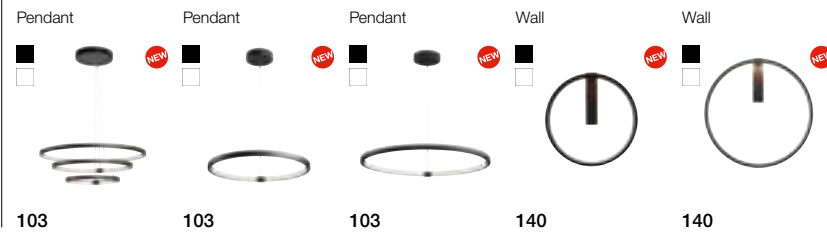

OPEN GRILL

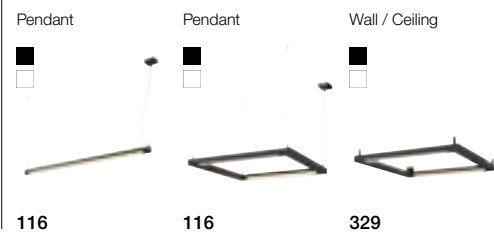



PARA CONE

Pendant 	Pendant 	Pendant 	3-Circuit Track 	3-Circuit Track 	1-Circuit Track 	1-Circuit Track
066	066	066	344	363	389	400

PHELIA

Design:
Markus Becker

Table 	Floor stand 	Pendant 	Pendant 	Pendant 	Pendant 	Wall
026	026	056	057	057	057	203

PHOTONIA

Pendant 	Table 	Path / Stand 	Wall 	Ceiling
532	541	547	614	672

PLASTRA

Pendant 	Pendant 	Pendant 	Pendant 	Wall 	Wall 	Wall
048	049	049	070	137	137	154
Wall 	Wall 	Wall 	Wall 	Wall 	Wall 	Wall
155	159	159	170	174	174	175
Wall 	Wall 	Wall 	Ceiling 	Ceiling 	Ceiling 	Ceiling
180	180	180	240	240	240	272
Ceiling 	Ceiling 	Ceiling 	Recessed 	Recessed 		
272	273	273	453	453		



P-LIGHT



POLE PARC



PURI

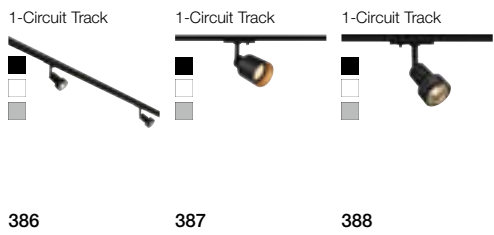

Q-LINE

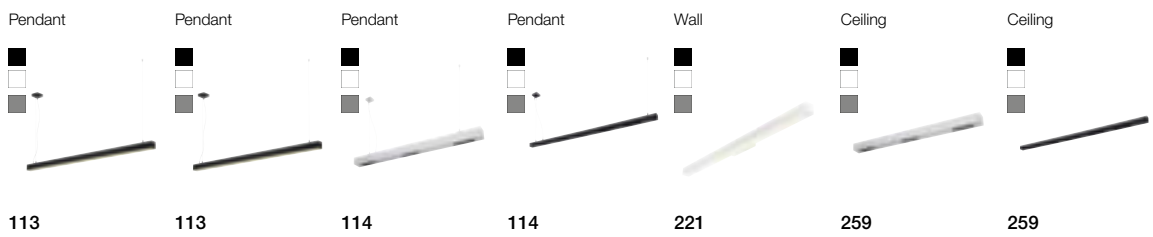

QUAD



QUADRASYL

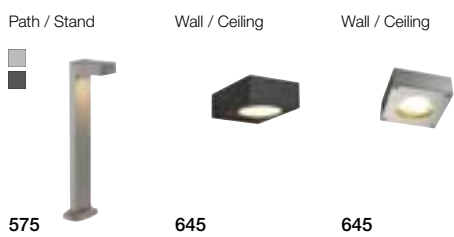



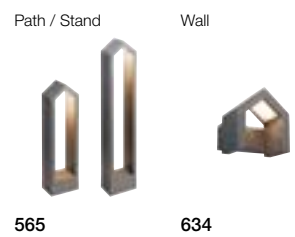







RASCALI













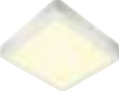

ROTOBALL

Pendant	Pendant	Pendant	Ceiling	Ceiling
				
080	080	080	260	260
Pendant	Pendant	Stand	Stand	Stand
				
533	533	538	538	538



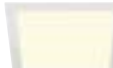

ROX

Wall	Wall	Ceiling	Path / Stand	Path / Stand	Path / Stand
					
178, 630	178, 656	266, 676	553	553	553
Ceiling	Ceiling				
					
676	676				

SENSER











Wall / Ceiling	Wall / Ceiling	Wall / Ceiling	Wall / Ceiling	Wall / Ceiling	Wall / Ceiling
					
324	324	324	325	325	325
Recessed	Recessed	Recessed	Recessed	Recessed	Recessed
					
510	510	510	511	511	511

SIGHT LED

Wall / Ceiling	Wall / Ceiling	3-Circuit Track	3-Circuit Track	3-Circuit Track
				
328	328	337	349	362



SITRA

Path / Stand  582	Spike  591	Spike  591	Wall  629	Wall  629	Wall  654	Wall  654
Wall  663	Wall  663	Ceiling  674	Wall / Ceiling  690			





SLOTS

Path / Stand  563	Path / Stand  563	Wall  616				
--	--	--	--	--	--	--









SOPRANA

Pendant  082	Wall  147	Wall  149	Ceiling  237
---	--	--	---

SPOT E27

Wall  225	Wall / Ceiling  282	3-Circuit Track  342	1-Circuit Track  388
--	--	---	---

SQUARE

Path / Stand  559	Path / Stand  559	Path / Stand  559	Wall  620	Wall  620	Wall  657
Ceiling  677	Ceiling  677				



STRUCTEC

3-Circuit Track	3-Circuit Track	3-Circuit Track	3-Circuit Track	3-Circuit Track	1-Circuit Track
336	356	356	356	357	398

SUPROS

Pendant	Ceiling	3-Circuit Track	Recessed	Recessed	
125	277	355	506	507	

SUPROS 78

Pendant	Wall	Ceiling	3-Circuit Track	Recessed	Recessed
124	179	277	354	504	505

TEC KALU

Wall / Ceiling	Wall / Ceiling	3-Circuit Track	3-Circuit Track
268	268	352	352

TENORA

Wall	Ceiling
191	237

THEO

Wall	Path / Stand	Path / Stand	Wall	Wall	Ceiling
161	578	578	650	665	678

TONGA

Pendant	1-Circuit Track	Easytec® II
077	400	414

TOTHEE

Wall / Ceiling	2-Circuit Track
287	378



TRAPECCO

Path / Stand

Wall



576

644

TRUST

Path / Stand

Path / Stand

Wall



551

551

619

VINCELLI D

Table

Pendant

Wall

Wall



012

053

223

223

WORKLIGHT

Stand

Stand

Pendant

Pendant

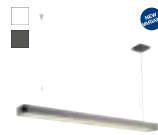
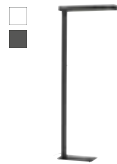

030

031

120

121



1000681 617

1000683 549

Information: You will find the 7-digit i em number from page 906 onwards

111000	113450..... 483	114261..... 495	115556..... 497
111260..... 444	113451..... 483	114270..... 495	115600..... 501
111262..... 444	113456..... 483	114271..... 495	115624..... 501
111290..... 443	113490..... 485	114280..... 495	115634..... 501
111292..... 443	113491..... 485	114281..... 495	115700..... 498
111360..... 485	113492..... 486	114290..... 495	115701..... 498
111361..... 485	113510..... 485	114291..... 495	115706..... 498
111362..... 486	113511..... 485	114380..... 490	115710..... 498
111380..... 487	113512..... 486	114381..... 490	115711..... 498
111381..... 487	113540..... 487	114386..... 490	115716..... 498
111382..... 487	113541..... 487	114390..... 490	115720..... 498
111482..... 645	113550..... 487	114391..... 490	115721..... 498
111710..... 484	113830..... 487	114396..... 490	115726..... 498
111711..... 484	113840..... 487	114400..... 488	115730..... 499
111716..... 484	113841..... 487	114401..... 488	115731..... 499
111720..... 484	113870..... 492	114406..... 488	115736..... 499
111721..... 484	113871..... 492	114420..... 467, 711	115740..... 499
111726..... 484	113876..... 492	114421..... 467, 711	115741..... 499
111830..... 861	113880..... 492	114426..... 467, 711	115746..... 499
111831..... 861	113881..... 492	114430..... 467, 711	
111832..... 861	113886..... 492	114431..... 467, 711	116000
111833..... 861	113890..... 493	114436..... 467, 711	116302..... 124
111850..... 860	113891..... 493	114440..... 465, 709	116304..... 124
111860..... 860	113896..... 493	114441..... 465, 709	116310..... 504
111861..... 860	113900..... 492	114450..... 465, 709	116311..... 504
111862..... 860	113901..... 492	114451..... 465, 709	116320..... 505
	113906..... 492	114460..... 708	116321..... 505
112000	113910..... 492	114461..... 708	116330..... 277
112161..... 450	113911..... 492	114470..... 708	116331..... 277
112162..... 450	113916..... 492	114471..... 708	116340..... 179
112165..... 450	113920..... 493	114480..... 458	116341..... 179
112221..... 450	113921..... 493	114481..... 458	
112222..... 450	113926..... 493	114490..... 458	117000
112225..... 450	113930..... 271	114491..... 458	117100..... 274
112240..... 450	113931..... 271	114500..... 459	117101..... 274
112242..... 450	113936..... 271	114501..... 459	117110..... 274
112471..... 451	113940..... 271		117111..... 274
112474..... 451	113941..... 271	115000	117120..... 275
112682..... 512	113946..... 271	115011..... 501	117121..... 275
112692..... 513	113951..... 489	115014..... 501	117130..... 275
112702..... 513	113956..... 489	115104..... 501	117131..... 275
112720..... 451	113961..... 489	115114..... 501	117160..... 276
112721..... 451	113966..... 489	115151..... 501	117161..... 276
112726..... 451	113970..... 488	115152..... 501	117180..... 276
112731..... 444	113971..... 488	115183..... 502	117181..... 276
112732..... 444	113976..... 488	115193..... 502	117311..... 469
112771..... 443		115203..... 503	117321..... 263
112772..... 443	114000	115213..... 503	117331..... 469
112780..... 443	114102..... 125	115223..... 503	117341..... 469
112781..... 443	114104..... 125	115233..... 503	117351..... 262
112910..... 473	114110..... 506	115243..... 503	117361..... 263
112911..... 473	114111..... 506	115253..... 503	117381..... 263
	114120..... 507	115304..... 500	
113000	114121..... 507	115314..... 500	118000
113110..... 473	114130..... 277	115351..... 500	118110..... 506
113111..... 473	114131..... 277	115352..... 500	118111..... 506
113140..... 471	114160..... 506	115414..... 500	118120..... 507
113141..... 471	114161..... 506	115510..... 496	118121..... 507
113150..... 471	114170..... 507	115511..... 496	118130..... 277
113151..... 471	114171..... 507	115516..... 496	118131..... 277
113160..... 471	114180..... 277	115520..... 496	118160..... 506
113161..... 471	114181..... 277	115521..... 496	118161..... 506
113170..... 472	114220..... 494	115526..... 496	118170..... 507
113171..... 472	114221..... 494	115530..... 496	118171..... 507
113260..... 444	114230..... 494	115531..... 496	118180..... 277
113262..... 444	114231..... 494	115536..... 496	118181..... 277
113290..... 443	114240..... 495	115540..... 497	
113292..... 443	114241..... 495	115541..... 497	132000
113440..... 483	114250..... 495	115546..... 497	132020..... 283
113441..... 483	114251..... 495	115550..... 497	132021..... 283
113446..... 483	114260..... 495	115551..... 497	132024..... 283

132600.....	040	134323.....	315	140221.....	378	143380.....	405
132601.....	040	134333.....	315	140240.....	378	143381.....	405
132605.....	040	134343.....	315	140241.....	378	143382.....	405
132610.....	040			140243.....	378	143390.....	388
132611.....	040	135000		140250.....	378	143391.....	388
132615.....	040	135020.....	090, 246	140251.....	378	143392.....	388
132620.....	040	135021.....	090, 246	140260.....	378	143430.....	391
132621.....	040	135024.....	090, 246	140261.....	378	143431.....	391
132625.....	040	135026.....	090, 246			143432.....	391
132650.....	036	135070.....	091, 247	143000		143440.....	391
132651.....	036	135071.....	091, 247	143010.....	404	143441.....	391
132660.....	044	135074.....	091, 247	143011.....	404	143442.....	391
132661.....	044	135076.....	091, 247	143012.....	404	143450.....	387
132662.....	044	135120.....	092, 248	143020.....	404	143451.....	387
132670.....	858	135121.....	092, 248	143021.....	404	143454.....	387
132671.....	858	135124.....	092, 248	143022.....	404	143540.....	395
132680.....	858	135126.....	092, 248	143030.....	405	143541.....	395
132681.....	858	135170.....	093, 249	143031.....	405	143544.....	395
132690.....	037	135171.....	093, 249	143032.....	405	143560.....	398
132691.....	037	135174.....	093, 249	143040.....	405	143561.....	398
132832.....	542	135176.....	093, 249	143041.....	405	143580.....	397
132835.....	542	135250.....	067	143042.....	405	143581.....	397
		135251.....	067	143050.....	405	143594.....	400
133000		135254.....	067	143051.....	405	143620.....	399
133001.....	066			143052.....	405	143621.....	399
133005.....	066	138000		143060.....	405	143731.....	395
133009.....	066	138980.....	429, 847	143061.....	405	143801.....	393
133011.....	066	138981.....	429, 847	143062.....	405	143804.....	393
133015.....	066	138982.....	429, 847	143070.....	405	143811.....	392
133019.....	066	138990.....	429, 847	143071.....	405	143814.....	392
133050.....	066	138991.....	429, 847	143072.....	405	143930.....	401
133060.....	066	138992.....	429, 847	143080.....	405	143931.....	401
133070.....	066			143081.....	405	143932.....	401
133100.....	125	139000		143082.....	405	143941.....	397
133101.....	125	139004.....	428	143090.....	405	143951.....	397
133110.....	125	139006.....	429	143091.....	405	143960.....	399
133111.....	125	139024.....	428	143092.....	405	143961.....	399
133120.....	124	139026.....	428	143100.....	405	143964.....	399
133121.....	124	139030.....	428	143101.....	405	143990.....	400
133140.....	125	139031.....	428	143102.....	405	143991.....	400
133141.....	125	139040.....	428	143110.....	405		
133150.....	125	139041.....	428	143111.....	405	144000	
133151.....	125	139050.....	428	143112.....	405	144010.....	388
133300.....	056	139051.....	428	143120.....	040	144011.....	388
133310.....	057	139060.....	429	143121.....	040	144013.....	388
133320.....	057	139061.....	429	143124.....	040	144019.....	388
133330.....	057	139070.....	420	143130.....	405	144200.....	387
133341.....	068	139071.....	420	143131.....	405	144201.....	387
133351.....	068	139072.....	420	143132.....	405	144204.....	387
133444.....	077	139080.....	420	143151.....	405		
133464.....	077	139081.....	420	143152.....	402	145000	
133481.....	050	139082.....	420	143160.....	405	145100.....	369
133482.....	050	139090.....	421	143161.....	405	145102.....	369
133483.....	050	139091.....	421	143162.....	405	145200.....	369
133489.....	050	139092.....	421	143169.....	405	145202.....	369
133490.....	050	139100.....	421	143170.....	402	145300.....	369
133491.....	050	139101.....	421	143171.....	402	145302.....	369
133493.....	050	139102.....	421	143172.....	402	145510.....	370
133499.....	050	139110.....	423	143190.....	386	145514.....	370
133840.....	100	139111.....	423	143191.....	386	145520.....	370
133841.....	100	139112.....	423	143194.....	386	145524.....	370
133850.....	100	139120.....	425	143221.....	402	145530.....	370
133851.....	100	139121.....	425	143230.....	402	145534.....	370
133881.....	061	139122.....	425	143231.....	402	145551.....	373
133886.....	061	139130.....	422	143241.....	402	145560.....	370
133887.....	061	139131.....	422	143251.....	402	145564.....	370
133891.....	061	139132.....	422	143261.....	402	145580.....	371
133896.....	061			143271.....	402	145581.....	371
133897.....	061	140000		143281.....	402	145584.....	371
		140200.....	378	143291.....	402	145590.....	371
134000		140201.....	378	143350.....	395	145594.....	371
134001.....	075	140210.....	378	143351.....	395	145600.....	371
134011.....	075	140211.....	378	143354.....	395	145604.....	371

145630.....	370	147559.....	283	151511.....	267	152420.....	346
145634.....	370	147566.....	162	151514.....	267	152421.....	346
145640.....	370	147821.....	171	151531.....	267, 284	152430.....	346
145644.....	370	147823.....	171	151534.....	267, 284	152431.....	346
145660.....	370	147826.....	171	151553.....	212	152600.....	359
145664.....	370	147841.....	171	151561.....	185	152601.....	359
145670.....	370	147843.....	171	151564.....	185	152610.....	358
145674.....	370	147846.....	171	151591.....	145	152611.....	358
145680.....	371			151600.....	173	152614.....	358
145684.....	371	148000		151601.....	173	152620.....	355
145690.....	371	148001.....	240	151610.....	173	152621.....	355
145694.....	371	148002.....	240	151611.....	173	152640.....	343
145700.....	371	148004.....	272	151710.....	172	152641.....	343
145710.....	371	148005.....	240	151711.....	172	152644.....	343
145714.....	371	148010.....	159	151740.....	172	152660.....	354
145720.....	371	148012.....	180	151741.....	172	152661.....	354
145724.....	371	148013.....	180	151781.....	164	152680.....	355
145730.....	371	148015.....	159	151786.....	164	152681.....	355
145734.....	371	148016.....	174	151791.....	164	152750.....	353
145830.....	371	148018.....	155	151796.....	164	152751.....	353
145834.....	371	148019.....	137	151800.....	177	152754.....	353
145990.....	040	148040.....	049	151801.....	177	152760.....	353
145994.....	040	148042.....	070	151803.....	177	152761.....	353
		148051.....	272	151804.....	177	152764.....	353
146000		148052.....	273	151810.....	265	152780.....	353
146000.....	026	148053.....	273	151811.....	265	152781.....	353
146001.....	026	148060.....	175	151813.....	265	152784.....	353
146010.....	026	148061.....	180	151814.....	265	152790.....	353
146011.....	026	148062.....	170	151820.....	290	152791.....	353
146111.....	015	148070.....	453	151821.....	290	152794.....	353
146242.....	446	148071.....	453	151830.....	290	152800.....	355
146252.....	446	148091.....	137	151831.....	290	152801.....	355
146260.....	446	148540.....	203	151840.....	177	152810.....	355
146332.....	225			151850.....	070	152811.....	355
146452.....	224	149000		151851.....	070	152960.....	346
146472.....	228	149060.....	291	151853.....	070	152961.....	346
146479.....	861	149061.....	291	151854.....	070	152980.....	349
146482.....	224	149070.....	291	151950.....	441	152981.....	349
146512.....	209	149071.....	291	151951.....	441		
146680.....	208	149380.....	077	151952.....	441	153000	
146682.....	208	149381.....	071	151960.....	441	153102.....	344
146692.....	207	149385.....	071	151961.....	441	153112.....	363
146700.....	206	149387.....	071	151962.....	441	153130.....	363
146701.....	206	149388.....	071			153131.....	363
146704.....	206	149431.....	142	152000		153140.....	363
146800.....	219	149452.....	196	152010.....	289	153141.....	363
146801.....	219	149471.....	163	152011.....	289	153420.....	360
146804.....	219	149472.....	163	152013.....	289	153421.....	360
146942.....	260	149511.....	163	152020.....	289	153424.....	360
		149512.....	163	152021.....	289	153560.....	350
147000		149752.....	211	152023.....	289	153561.....	350
147301.....	304	149762.....	211	152101.....	266	153564.....	350
147306.....	304	149772.....	211	152200.....	342	153580.....	358
147311.....	304	149782.....	210	152201.....	342	153581.....	358
147316.....	304			152204.....	342	153584.....	358
147321.....	304	151000		152230.....	351	153600.....	359
147326.....	304	151040.....	050	152231.....	351	153810.....	361
147360.....	303	151041.....	050	152232.....	351	153811.....	361
147361.....	303	151049.....	050	152240.....	351	153814.....	361
147370.....	303	151271.....	167	152241.....	351	153850.....	360
147371.....	303	151275.....	167	152242.....	351	153851.....	360
147380.....	303	151282.....	214	152320.....	343	153854.....	360
147381.....	303	151311.....	166	152321.....	343		
147411.....	295	151315.....	166	152324.....	343	155000	
147412.....	295	151320.....	156	152330.....	286	155100.....	200
147414.....	295	151321.....	156	152331.....	286	155101.....	200
147441.....	301	151325.....	156	152340.....	205	155104.....	200
147442.....	301	151410.....	168	152341.....	205	155114.....	200
147443.....	301	151411.....	168	152360.....	073	155152.....	314
147444.....	301	151416.....	168	152361.....	073	155156.....	314
147529.....	145	151450.....	168	152370.....	073	155180.....	317
147550.....	283	151451.....	168	152371.....	073	155185.....	317
147551.....	283	151456.....	168	152380.....	447	155206.....	169
				152381.....	447	155216.....	169

155221.....	162	156510.....	292	165400.....	080	175164.....	367
155228.....	162	156511.....	292	165410.....	080	175180.....	367
155236.....	316	156530.....	447			175184.....	367
155290.....	085	156531.....	447	170000		175190.....	341, 367
155300.....	084			170401.....	229	175194.....	367
155340.....	149	157000		170402.....	229	175200.....	367
155372.....	237	157671.....	116			175204.....	367
155373.....	237	157701.....	080	172000		175210.....	367
155380.....	084	157901.....	030	172010.....	380	175214.....	367
155462.....	082	157905.....	030	172011.....	380		
155463.....	082			172020.....	380	176000	
155471.....	066	158000		172021.....	380	176080.....	356
155475.....	066	158400.....	072	172030.....	380	176081.....	356
155479.....	066	158401.....	072	172031.....	380	176090.....	356
155490.....	020	158410.....	072	172040.....	381	176091.....	356
155492.....	020	158411.....	072	172041.....	381		
155500.....	062	158663.....	522	172050.....	381	181000	
155510.....	062	158664.....	522	172051.....	381	181530.....	429
155511.....	062	158723.....	107	172060.....	381	181531.....	429
155520.....	062	158724.....	107	172061.....	381	181532.....	429
155530.....	062	158733.....	107	172070.....	381		
155531.....	062	158734.....	107	172071.....	381	184000	
155540.....	020	158853.....	106	172080.....	381	184000.....	415
155550.....	234	158854.....	106	172081.....	381	184002.....	415
155551.....	234	158941.....	258	172090.....	381	184004.....	415
155552.....	234	158951.....	258	172091.....	381	184010.....	415
155570.....	047	158961.....	258	172100.....	381	184012.....	415
155582.....	019, 021, 047, 235	158969.....	258	172101.....	381	184020.....	415
155583.....	019, 021, 047, 235	158971.....	258	172110.....	381	184022.....	415
155592.....	019, 021, 047, 235			172111.....	381	184030.....	415
155643.....	149	159000		172120.....	381	184032.....	415
155650.....	082	159140.....	117	172121.....	381	184040.....	415
155651.....	024	159141.....	117	172134.....	381	184042.....	415
155652.....	024	159144.....	117	172145.....	381	184060.....	415
155670.....	194	159210.....	118	172190.....	381	184062.....	415
155673.....	194	159211.....	118	172191.....	381	184071.....	412
155714.....	076	159214.....	118	172200.....	381	184140.....	415
155752.....	143	159220.....	118	172201.....	381	184142.....	415
155780.....	018	159221.....	118	172220.....	381	184170.....	415
155785.....	018	159224.....	118	172221.....	381	184172.....	415
155790.....	018	159230.....	118			184290.....	415
155795.....	018	159231.....	118	175000		184292.....	415
155861.....	147	159234.....	118	175010.....	365	184300.....	415
155870.....	083			175014.....	365	184302.....	415
155871.....	083	160000		175020.....	365	184330.....	415
155900.....	065	160900.....	108	175024.....	365	184332.....	415
155901.....	065	160901.....	108	175030.....	365	184440.....	411
155910.....	065	160904.....	108	175034.....	365	184450.....	411
155911.....	065			175040.....	367	184452.....	411
155920.....	065	161000		175044.....	367	184530.....	414
155921.....	065	161271.....	457	175050.....	367	184534.....	414
155930.....	065	161281.....	457	175054.....	367	184560.....	410
155931.....	065	161291.....	457	175060.....	341, 367	184580.....	413
155960.....	055	161301.....	457	175064.....	367	184590.....	414
155970.....	055	161461.....	241	175070.....	367	184620.....	412
		161464.....	241	175074.....	367	184624.....	412
156000				175080.....	367	184630.....	412
156020.....	191	163000		175084.....	367	184634.....	412
156021.....	191	163020.....	318	175090.....	367	184690.....	413
156050.....	237	163021.....	319	175094.....	367		
156051.....	237	163030.....	319	175100.....	367	185000	
156100.....	022	163031.....	319	175104.....	367	185002.....	415
156111.....	019, 021, 022, 047, 235			175110.....	367	185012.....	415
156113.....	019, 021, 022, 047, 235	165000		175114.....	367	185020.....	415
156122.....	019, 021, 022, 047, 235	165100.....	129	175120.....	367	185032.....	415
156141.....	018, 020, 046	165160.....	129	175124.....	367	185042.....	415
156143.....	018, 020, 046	165221.....	129	175130.....	367	185062.....	415
156152.....	018, 020, 046	165222.....	129	175134.....	367	185142.....	415
156268.....	053	165350.....	128	175140.....	367	185172.....	415
156420.....	288	165356.....	128	175144.....	367	185294.....	415
156421.....	288	165358.....	128	175150.....	367	185302.....	415
156500.....	292	165359.....	128	175154.....	367	185440.....	411
156501.....	292	165390.....	080	175160.....	341, 367	185450.....	411

185580.....	413	213630.....	770	228120.....	619	229421.....	560
185582.....	413	213631.....	770	228130.....	551	229422.....	546
185590.....	414	213634.....	770	228210.....	721	229423.....	544
185592.....	414	213642.....	771	228214.....	721	229430.....	544
185622.....	412	213643.....	771	228240.....	721	229431.....	544
185632.....	412	213650.....	771	228332.....	717	229432.....	544
185692.....	413	213651.....	771	228342.....	717	229481.....	609
		213654.....	771	228370.....	730	229482.....	609
186000		213821.....	769	228411.....	722	229521.....	650
186015.....	433	213822.....	767, 769	228412.....	722	229524.....	650
186020.....	433	213862.....	767	228430.....	729	229525.....	650
186042.....	432	213874.....	767	228434.....	729	229531.....	665
186272.....	432	213911.....	768	228505.....	675	229532.....	665
186300.....	429	213914.....	768	228511.....	628	229535.....	665
186301.....	429	213931.....	769	228515.....	628	229551.....	678
186302.....	429	213934.....	769	228521.....	656	229554.....	678
186310.....	429	213939.....	769	228525.....	656	229555.....	678
186311.....	429	213950.....	764	228545.....	577	229561.....	650
186312.....	429	213951.....	764	228555.....	599	229564.....	650
186330.....	429	213954.....	764	228560.....	599	229565.....	650
186331.....	429	213962.....	765	228712.....	548	229571.....	665
186332.....	429	213970.....	765	228722.....	548	229574.....	665
186340.....	429	213971.....	765	228725.....	864	229575.....	665
186341.....	429	213974.....	765	228726.....	864	229581.....	678
186342.....	429			228730.....	864	229584.....	678
186350.....	429	214000		228752.....	557	229585.....	678
186351.....	429	214100.....	762	228753.....	547	229664.....	669
186352.....	429	214101.....	762	228754.....	558	229665.....	669
186360.....	429	214102.....	762	228771.....	654	229694.....	668
186361.....	429	214350.....	760	228775.....	654	229695.....	668
186362.....	429	214351.....	760	228776.....	654	229702.....	698
186640.....	429			228922.....	548	229740.....	589
186641.....	429	220000		228925.....	548	229741.....	597
186642.....	429	220000.....	861	228935.....	549	229931.....	684
186762.....	433			228945.....	549	229935.....	684
186772.....	433	227000		228960.....	540	229941.....	684
186952.....	433	227000.....	864	228961.....	540	229945.....	684
		227090.....	721	228965.....	540	229951.....	684
188000		227092.....	721			229955.....	684
188500.....	431	227140.....	846	229000		229961.....	680
188510.....	431	227160.....	846	229020.....	545	229965.....	680
188520.....	431	227174.....	622	229021.....	545	229971.....	680
188530.....	430	227176.....	622	229022.....	545	229975.....	680
188550.....	430	227185.....	633	229050.....	554		
		227194.....	635	229054.....	554	230000	
210000		227195.....	635	229057.....	554	230030.....	643
210060.....	859	227198.....	635	229059.....	554	230034.....	643
210061.....	859	227219.....	538	229062.....	698	230044.....	627
210064.....	859	227220.....	538	229071.....	682	230045.....	627
		227221.....	538	229072.....	682	230060.....	550
213000		227410.....	588	229075.....	682	230061.....	554
213440.....	776	227418.....	588	229081.....	682	230063.....	554
213441.....	776	227461.....	716	229084.....	682	230066.....	554
213444.....	776	227462.....	716	229085.....	682	230069.....	554
213450.....	777	227504.....	590	229090.....	595	230084.....	627
213451.....	777	227505.....	590	229100.....	597	230085.....	627
213454.....	777	227507.....	590	229110.....	701	230090.....	573
213459.....	777	227508.....	590	229162.....	552	230100.....	734
213470.....	772	227550.....	537	229172.....	552	230110.....	734
213471.....	772	227600.....	719	229182.....	619	230170.....	719
213474.....	772	227604.....	719	229200.....	730	230174.....	719
213480.....	773	227680.....	718	229230.....	730	230355.....	629
213481.....	773	227684.....	718	229234.....	730	230365.....	654
213484.....	773	227700.....	670	229260.....	864	230435.....	543
213488.....	771, 773	227701.....	670	229262.....	865	230444.....	623
213489.....	773	227734.....	608	229269.....	864	230445.....	623
213511.....	774	227744.....	608	229320.....	729	230465.....	547
213514.....	774	227922.....	551	229324.....	729	230655.....	626
213521.....	775			229374.....	729	230657.....	626
213524.....	775	228000		229381.....	733		
213529.....	775	228050.....	533	229383.....	733	231000	
213620.....	770	228051.....	533	229410.....	571	231010.....	184, 633
213621.....	770	228100.....	551	229411.....	571	231012.....	184, 633
213624.....	770	228110.....	551	229420.....	560	231015.....	184, 633

231035.....	589	232165.....	566	233312.....	655	240004.....	743
231045.....	689	232175.....	567	233407.....	545	240006.....	742
231055.....	689	232185.....	567	233417.....	545	240007.....	740
231072.....	605	232195.....	566	233427.....	560	240008.....	741
231092.....	605	232285.....	645	233437.....	560	240009.....	743
231205.....	620	232294.....	575	233447.....	571	240010.....	743
231215.....	557	232295.....	575	233457.....	571	240020.....	740
231225.....	557	232405.....	637	233500.....	725	240021.....	741
231230.....	557	232415.....	637	233520.....	725	240022.....	743
231231.....	575	232431.....	183, 646	233530.....	725	240024.....	742
231233.....	562	232435.....	183, 646	233540.....	723		
231234.....	548	232441.....	158, 658	233550.....	723	410000	
231235.....	570	232445.....	158, 658	233570.....	598	410861.....	865
231245.....	533	232451.....	659	233571.....	598	410865.....	865
231305.....	575	232455.....	659	233580.....	598		
231315.....	642	232461.....	183, 646	233582.....	598	451000	
231351.....	641	232465.....	183, 646	233601.....	699	451105.....	846
231355.....	641	232471.....	158, 658	233605.....	699	451301.....	846
231360.....	541	232475.....	158, 658	233611.....	699		
231361.....	673	232481.....	662	233615.....	699	461000	
231370.....	570	232485.....	662	233621.....	699	461050.....	848
231371.....	570	232491.....	661	233625.....	699	461060.....	848
231410.....	561	232495.....	661	233635.....	700	461157.....	848
231411.....	561	232497.....	661	233639.....	700	461217.....	848
231420.....	562	232531.....	663	233650.....	701		
231440.....	570	232535.....	663	233660.....	701	464000	
231455.....	563	232537.....	663	233672.....	727	464030.....	857
231457.....	563	232800.....	600	233676.....	727	464031.....	856
231465.....	618	232810.....	600	233692.....	726	464032.....	855
231475.....	555	232820.....	601	233696.....	726	464091.....	856
231505.....	582	232830.....	601	233712.....	727	464107.....	856
231515.....	690	232840.....	603	233716.....	727	464108.....	856
231525.....	591	232850.....	603	233732.....	727	464109.....	856
231535.....	591	232860.....	603	233736.....	727	464140.....	852
231541.....	674	232864.....	603	233790.....	727	464142.....	853
231545.....	674	232870.....	603	233791.....	727	464143.....	441
231585.....	618	232874.....	603	233792.....	720	464144.....	852
231595.....	555	232880.....	603	233795.....	727	464168.....	857
231602.....	551	232884.....	603	233796.....	727	464170.....	857
231612.....	551	232890.....	603	233797.....	720	464200.....	857
231672.....	593	232894.....	603			464804.....	853
231682.....	593	232905.....	640	234000			
231745.....	644	232915.....	640	234205.....	607	470000	
231765.....	576			234215.....	607	470500.....	850
231805.....	616	233000		234225.....	607	470502.....	850
231807.....	616	233094.....	690	234235.....	607	470505.....	849
231815.....	563	233095.....	690	234245.....	607	470506.....	850
231817.....	563	233104.....	690	234255.....	607	470507.....	850
231835.....	572	233105.....	690	234340.....	600	470540.....	851
231845.....	572	233114.....	653	234344.....	604	470541.....	850
231849.....	572	233115.....	653	234350.....	600	470542.....	850
231855.....	564	233124.....	671	234354.....	604	470544.....	850
231865.....	636	233125.....	671	234401.....	028, 550	470545.....	850
231954.....	609	233134.....	671	234411.....	028, 550	470546.....	850
231955.....	609	233135.....	671	234421.....	028, 550	470547.....	851
231960.....	609	233144.....	583	234430.....	028	470548.....	851
231961.....	609	233145.....	583	234431.....	028	470549.....	851
		233164.....	583	234441.....	028	470550.....	849
232000		233165.....	583	234501.....	666	470670.....	829
232045.....	614	233184.....	583	234504.....	666	470671.....	829
232055.....	672	233185.....	583	234505.....	666	470672.....	829
232065.....	532	233211.....	628	234511.....	666	470674.....	830, 833
232075.....	547	233214.....	653	234514.....	666	470675.....	830, 833
232085.....	547	233215.....	628	234515.....	666	470677.....	829
232095.....	541	233225.....	629	234521.....	651	470680.....	833
232101.....	664	233231.....	653	234524.....	651	470681.....	807, 833
232104.....	664	233235.....	653	234525.....	651	470682.....	807, 833
232105.....	664	233241.....	691	234531.....	678	470683.....	807, 833
232115.....	558	233245.....	691	234534.....	678	470800.....	838
232119.....	558	233251.....	691	234535.....	678	470803.....	840
232125.....	558	233255.....	691			470804.....	840
232135.....	568	233275.....	583	240000		470806.....	840
232145.....	568	233285.....	583	240000.....	740	470807.....	840
232155.....	566	233302.....	655	240002.....	741	470808.....	839

470812.....	838	552693.....	795	560622.....	875	1000134.....	307
470821.....	839	552694.....	795	560624.....	875	1000135.....	307
470822.....	839	552702.....	793	560662.....	875	1000136.....	307
470823.....	839	552703.....	793	560702.....	873	1000137.....	307
470824.....	839	552704.....	793	560704.....	873	1000138.....	307
		552712.....	793	560712.....	874		
508000		552713.....	793	560714.....	874	1000300	
508211.....	240	552714.....	793	560722.....	874	1000324.....	203
		552722.....	793	560724.....	874	1000325.....	203
548000		552723.....	793	560732.....	874	1000326.....	203
548014.....	734	552724.....	793	560734.....	874	1000327.....	161
548021.....	734	552727.....	793	560741.....	879	1000328.....	161
548028.....	169	552732.....	783	560752.....	018	1000329.....	161
		552733.....	783	560762.....	547	1000330.....	161
550000		552734.....	783			1000331.....	665
550073.....	881	552742.....	783	570000		1000332.....	266, 676
550074.....	881	552743.....	783	570532.....	118	1000333.....	178, 630
550082.....	881	552744.....	783	570672.....	010	1000334.....	178, 656
550092.....	881	552752.....	783			1000335.....	657
550412.....	797, 805	552753.....	783	631000		1000336.....	620
550413.....	798, 799, 803	552754.....	783	631300.....	815	1000337.....	677
550415.....	797, 805	552762.....	783	631301.....	815	1000338.....	676
550416.....	798, 799, 803	552763.....	783	631302.....	815	1000339.....	676
550560.....	797, 798, 799, 803, 805	552764.....	783	631303.....	815	1000340.....	183, 652
550570.....	798, 799	552772.....	782	631304.....	815	1000341.....	183, 652
550571.....	797	552773.....	782	631305.....	815	1000342.....	183, 652
		552774.....	782	631313.....	815	1000343.....	559
551000		552782.....	782	631315.....	815	1000344.....	559
551242.....	869	552783.....	782	631317.....	815	1000345.....	559
551243.....	869	552784.....	782	631323.....	815	1000346.....	559
551252.....	871	552792.....	783	631325.....	815	1000384.....	720
551253.....	871	552793.....	783	631327.....	815	1000386.....	517
551372.....	881	552794.....	783	631337.....	327	1000387.....	517
551402.....	874	552802.....	787	631339.....	327	1000388.....	517
551412.....	874	552803.....	787	631347.....	327	1000389.....	517
551532.....	876	552804.....	787	631349.....	327	1000390.....	517
551602.....	875	552812.....	787	631501.....	813	1000391.....	517
551612.....	875	552813.....	787	631502.....	813	1000398.....	532
551862.....	432	552814.....	787	631505.....	813		
551882.....	873	552822.....	787	631510.....	813	1000400	
551893.....	228	552823.....	787	631512.....	813	1000400.....	537
551902.....	871	552824.....	787	631520.....	813	1000412.....	119
551912.....	873	552832.....	787	631521.....	813	1000413.....	119
551933.....	282	552833.....	787	631522.....	813	1000414.....	184
551944.....	127	552834.....	787	631523.....	813	1000415.....	184
		552852.....	787			1000416.....	559
552000		552853.....	787	900000		1000417.....	559
552120.....	799	552854.....	787	900011.....	597	1000418.....	559
552121.....	799	552863.....	807, 834			1000422.....	186
552122.....	799	552883.....	807, 834	955000		1000423.....	186
552273.....	812			955135.....	860	1000424.....	287
552422.....	797	560000				1000425.....	287
552423.....	797	560122.....	870	961000		1000426.....	287
552425.....	797	560142.....	653	961034.....	859	1000427.....	287
552442.....	798	560143.....	267	961037.....	859	1000433.....	059
552443.....	798	560161.....	020	961250.....	859	1000434.....	058
552445.....	798	560222.....	875	961270.....	859	1000435.....	058
552453.....	810, 830	560231.....	874	961271.....	859	1000436.....	058
552460.....	810	560232.....	874	961276.....	859	1000437.....	238
552461.....	810	560233.....	874	961370.....	859	1000438.....	059
552462.....	810	560234.....	874	961371.....	859	1000439.....	058
552463.....	810	560302.....	868	961376.....	859	1000440.....	058
552482.....	803	560332.....	868			1000441.....	058
552483.....	803	560352.....	868	977000		1000442.....	238
552485.....	803	560362.....	077	977399.....	773	1000443.....	238
552522.....	805	560372.....	875			1000445.....	238
552523.....	805	560402.....	876	1000100		1000446.....	657
552525.....	805	560422.....	876	1000127.....	306	1000447.....	675
552649.....	809	560432.....	018	1000128.....	306	1000448.....	631
552650.....	809	560463.....	881	1000129.....	306	1000449.....	551
552651.....	809	560473.....	881	1000130.....	306	1000457.....	749
552652.....	809	560542.....	870	1000131.....	306	1000458.....	749
552653.....	809	560552.....	870	1000132.....	306	1000459.....	749
552692.....	795	560603.....	070	1000133.....	307	1000460.....	749

1000461.....	749	1000533.....	753	1000654.....	727	1000762.....	556
1000462.....	749	1000534.....	753	1000655.....	720	1000763.....	022
1000463.....	749	1000535.....	757	1000656.....	357	1000764.....	022, 044
1000464.....	749	1000536.....	757	1000657.....	357	1000769.....	359
1000465.....	749	1000537.....	757	1000658.....	357	1000773.....	044
1000466.....	750	1000538.....	755	1000665.....	546	1000777.....	215
1000467.....	750	1000539.....	755	1000666.....	546	1000778.....	215
1000468.....	750	1000540.....	755	1000668.....	221	1000780.....	215
1000469.....	750	1000541.....	755	1000669.....	221	1000781.....	215
1000470.....	750	1000542.....	755	1000670.....	221	1000782.....	048
1000471.....	750	1000543.....	755	1000675.....	177	1000783.....	256
1000472.....	751	1000544.....	755	1000676.....	177	1000784.....	256
1000473.....	751	1000545.....	755	1000677.....	354	1000785.....	256
1000474.....	751	1000546.....	755	1000678.....	354	1000786.....	256
1000475.....	751	1000547.....	755	1000679.....	355	1000791.....	515
1000476.....	751	1000548.....	755	1000680.....	355	1000792.....	515
1000477.....	751	1000549.....	755	1000681.....	617	1000793.....	515
1000478.....	751	1000550.....	755	1000682.....	549	1000794.....	515
1000479.....	751	1000551.....	755	1000683.....	549	1000795.....	513
1000480.....	751	1000552.....	755	1000684.....	873	1000796.....	513
1000481.....	751	1000553.....	755	1000685.....	259	1000797.....	634
1000482.....	751	1000554.....	755	1000686.....	259	1000799.....	565
1000483.....	751	1000555.....	755	1000687.....	259		
1000484.....	751	1000556.....	756	1000688.....	259	1000800	
1000485.....	751	1000557.....	756	1000689.....	259	1000801.....	565
1000486.....	751	1000558.....	756	1000690.....	259	1000807.....	265
1000487.....	750	1000559.....	756	1000691.....	259	1000808.....	265
1000488.....	750	1000560.....	756	1000692.....	259	1000809.....	074
1000489.....	750	1000561.....	756	1000693.....	259	1000810.....	074, 265
1000490.....	754	1000562.....	756	1000694.....	259	1000811.....	074, 265
1000491.....	754	1000563.....	756	1000695.....	259	1000812.....	074, 265
1000492.....	754	1000564.....	756	1000696.....	259	1000813.....	074
1000493.....	754	1000565.....	756			1000814.....	074
1000494.....	754	1000566.....	756	1000700		1000816.....	216
1000495.....	754	1000567.....	756	1000700.....	865	1000818.....	216
1000496.....	754	1000568.....	756	1000701.....	865	1000820.....	614
1000497.....	754	1000569.....	756	1000702.....	304	1000821.....	532
1000498.....	754	1000570.....	756	1000703.....	304	1000822.....	550
1000499.....	753	1000571.....	755	1000704.....	304	1000823.....	672
		1000574.....	443	1000707.....	344	1000824.....	151
1000500		1000575.....	443	1000708.....	344	1000825.....	153, 199
1000500.....	753	1000576.....	444	1000709.....	363	1000826.....	835
1000501.....	753	1000577.....	444	1000710.....	363	1000827.....	130
1000502.....	753	1000579.....	019, 021, 047, 235	1000711.....	397	1000828.....	130
1000503.....	753	1000580.....	019, 021, 047, 235	1000712.....	397	1000833.....	705
1000504.....	753	1000581.....	036	1000713.....	399	1000834.....	620
1000505.....	753	1000587.....	668	1000714.....	454	1000835.....	677
1000506.....	753	1000588.....	668	1000715.....	454	1000855.....	092, 248
1000507.....	753			1000716.....	454	1000856.....	092, 248
1000508.....	753	1000600		1000717.....	454	1000857.....	092, 248
1000509.....	753	1000613.....	150	1000718.....	455	1000864.....	092, 248
1000510.....	753	1000614.....	152	1000719.....	455	1000865.....	092, 248
1000511.....	753	1000615.....	198	1000720.....	455	1000866.....	092, 248
1000512.....	753	1000616.....	151	1000721.....	455	1000868.....	862
1000513.....	753	1000618.....	151	1000722.....	010	1000869.....	862
1000514.....	753	1000619.....	151	1000723.....	010	1000870.....	862
1000515.....	753	1000621.....	153, 199	1000724.....	010	1000871.....	862
1000516.....	753	1000623.....	153, 199	1000725.....	098, 254	1000872.....	862
1000517.....	753	1000624.....	153, 199	1000726.....	098, 254	1000873.....	862
1000518.....	753	1000626.....	153, 199	1000727.....	098, 254	1000874.....	863
1000519.....	753	1000628.....	153, 199	1000729.....	204	1000875.....	863
1000520.....	753	1000629.....	153, 199	1000730.....	204	1000876.....	863
1000521.....	753	1000631.....	266	1000731.....	204	1000877.....	863
1000522.....	753	1000634.....	167	1000732.....	204	1000878.....	863
1000523.....	753	1000635.....	167	1000733.....	227	1000879.....	863
1000524.....	753	1000636.....	167	1000734.....	227	1000880.....	670
1000525.....	753	1000637.....	167	1000735.....	599	1000881.....	670
1000526.....	753	1000638.....	156	1000736.....	580	1000882.....	670
1000527.....	753	1000639.....	156	1000743.....	139	1000886.....	299
1000528.....	753	1000640.....	156	1000745.....	139	1000887.....	299
1000529.....	753	1000650.....	171	1000746.....	139	1000888.....	299
1000530.....	753	1000651.....	171	1000748.....	139	1000889.....	299
1000531.....	753	1000652.....	171	1000760.....	556	1000890.....	299
1000532.....	753	1000653.....	726	1000761.....	556	1000891.....	299

1000892.....	299	1001019.....	329	1001297.....	116	1001424.....	268
1000893.....	299	1001020.....	329	1001299.....	220	1001425.....	268
1000894.....	299	1001028.....	873			1001426.....	268
1000895.....	299	1001029.....	873	1001300		1001427.....	352
1000896.....	299	1001030.....	871	1001300.....	220	1001428.....	352
1000897.....	299	1001031.....	877	1001301.....	220	1001429.....	352
		1001032.....	877	1001303.....	220	1001430.....	352
1000900		1001033.....	877	1001304.....	220	1001431.....	268
1000906.....	452	1001035.....	880	1001305.....	220	1001432.....	268
1000907.....	452	1001038.....	880	1001306.....	113	1001433.....	268
1000908.....	452			1001307.....	113	1001434.....	268
1000909.....	860	1001100		1001308.....	113	1001435.....	293
1000910.....	155	1001114.....	853	1001309.....	113	1001436.....	293
1000911.....	155	1001115.....	853	1001310.....	113	1001447.....	107
1000914.....	474	1001132.....	517	1001312.....	113	1001448.....	107
1000915.....	474	1001133.....	517	1001314.....	687	1001449.....	192
1000916.....	474	1001136.....	517	1001315.....	687	1001450.....	192
1000917.....	474	1001153.....	838	1001316.....	687	1001451.....	192
1000918.....	130	1001155.....	448	1001317.....	687	1001452.....	192
1000926.....	114	1001156.....	448	1001343.....	104	1001453.....	192
1000927.....	114	1001157.....	460, 706	1001344.....	104	1001454.....	192
1000928.....	114	1001161.....	460, 706	1001345.....	104	1001460.....	025
1000929.....	114	1001165.....	461, 707	1001346.....	104	1001461.....	025
1000930.....	114	1001166.....	461, 707	1001347.....	104	1001462.....	025
1000931.....	114	1001167.....	461, 707	1001348.....	104	1001463.....	025
1000932.....	114	1001168.....	461, 707	1001350.....	058	1001464.....	227
1000933.....	114	1001169.....	461, 707	1001351.....	058	1001465.....	227
1000934.....	114	1001170.....	461, 707	1001352.....	378	1001466.....	345
1000935.....	114	1001171.....	461, 707	1001354.....	378	1001467.....	345
1000936.....	114	1001172.....	461, 707	1001355.....	378	1001468.....	189
1000937.....	114			1001357.....	880	1001469.....	189
1000939.....	873	1001200		1001359.....	714	1001470.....	345
1000940.....	873	1001217.....	026	1001367.....	361	1001471.....	345
1000941.....	873	1001220.....	048	1001368.....	361	1001472.....	189
1000942.....	873	1001221.....	049	1001369.....	361	1001473.....	189
1000957.....	047	1001242.....	872	1001375.....	365	1001474.....	345
1000974.....	398	1001243.....	872	1001376.....	365	1001475.....	345
1000975.....	398	1001244.....	872	1001377.....	365	1001476.....	361
1000976.....	398	1001245.....	872	1001378.....	367	1001477.....	361
1000977.....	398	1001249.....	857	1001379.....	367	1001478.....	361
1000978.....	398	1001250.....	523	1001380.....	341, 367	1001479.....	361
1000979.....	398	1001251.....	523	1001381.....	367	1001480.....	361
1000980.....	356	1001252.....	715	1001382.....	367	1001481.....	361
1000981.....	356	1001253.....	715	1001383.....	367	1001482.....	361
1000982.....	356	1001254.....	715	1001384.....	367	1001483.....	361
1000983.....	356	1001255.....	715	1001385.....	367	1001484.....	361
1000984.....	356	1001256.....	715	1001386.....	367	1001485.....	392
1000985.....	356	1001262.....	715	1001387.....	367	1001486.....	392
1000986.....	356	1001263.....	715	1001388.....	367	1001487.....	392
1000987.....	356	1001264.....	464	1001389.....	367	1001488.....	553
1000988.....	356	1001265.....	059	1001390.....	341, 367	1001489.....	553
1000989.....	356	1001266.....	058	1001392.....	367	1001490.....	553
1000990.....	356	1001267.....	853	1001393.....	341, 367	1001491.....	553
1000991.....	356	1001269.....	348	1001394.....	367	1001492.....	553
1000992.....	356	1001270.....	348	1001395.....	367	1001493.....	553
1000993.....	356	1001271.....	174			1001494.....	553
1000994.....	356	1001272.....	148	1001400		1001495.....	286
1000995.....	356	1001273.....	148	1001400.....	112	1001496.....	286
1000996.....	356	1001274.....	148	1001401.....	112		
1000997.....	356	1001275.....	148	1001402.....	112	1001500	
1000998.....	356	1001276.....	148	1001403.....	112	1001502.....	012
1000999.....	356	1001283.....	328	1001404.....	112	1001503.....	210
		1001284.....	328	1001405.....	112	1001505.....	257
1001000		1001285.....	328	1001406.....	112	1001506.....	257
1001000.....	356	1001286.....	328	1001407.....	112	1001508.....	257
1001001.....	356	1001287.....	328	1001408.....	112	1001509.....	257
1001002.....	356	1001288.....	328	1001409.....	112	1001510.....	369
1001003.....	356	1001289.....	349	1001410.....	112	1001511.....	369
1001009.....	227	1001290.....	349	1001411.....	112	1001512.....	369
1001010.....	227	1001292.....	349	1001419.....	352	1001513.....	370
1001015.....	463, 711, 745	1001293.....	329	1001420.....	352	1001514.....	370
1001016.....	463, 711, 745	1001294.....	329	1001421.....	352	1001515.....	370
1001017.....	463, 711, 745	1001295.....	116	1001422.....	352	1001516.....	370
1001018.....	463, 711, 745	1001296.....	116	1001423.....	268	1001517.....	370

1001518.....	370	1001807.....	760	1001895.....	096, 252	1001995.....	482
1001519.....	370	1001808.....	760	1001896.....	096, 252	1001996.....	482
1001520.....	370	1001809.....	760	1001897.....	096, 252	1001997.....	552
1001521.....	371	1001810.....	761	1001898.....	096, 252	1001998.....	552
1001522.....	371	1001813.....	760	1001899.....	096, 252	1001999.....	548
1001523.....	371	1001814.....	759				
1001524.....	371	1001815.....	760	1001900		1002000	
1001525.....	371	1001816.....	759	1001900.....	096, 252	1002000.....	548
1001526.....	371	1001817.....	759	1001901.....	518	1002001.....	548
1001527.....	371	1001818.....	040	1001902.....	519	1002002.....	614
1001528.....	371	1001819.....	040	1001903.....	519	1002003.....	271
1001529.....	371	1001820.....	040	1001904.....	519	1002004.....	269
1001530.....	371	1001821.....	040	1001905.....	520	1002005.....	270
1001531.....	373	1001822.....	200	1001906.....	520	1002006.....	270
1001532.....	373	1001823.....	573	1001907.....	520	1002008.....	271
1001533.....	373	1001824.....	573	1001908.....	521	1002010.....	269
1001534.....	373	1001825.....	477	1001909.....	681	1002011.....	269
1001536.....	373	1001826.....	477	1001910.....	681	1002012.....	269
1001537.....	373	1001827.....	477	1001911.....	681	1002013.....	269
1001538.....	373	1001828.....	476	1001912.....	681	1002015.....	269
1001539.....	373	1001829.....	476	1001913.....	681	1002016.....	629
1001542.....	040	1001830.....	476	1001914.....	681	1002017.....	629
1001560.....	870	1001831.....	476	1001916.....	876	1002018.....	654
1001561.....	870	1001832.....	476	1001917.....	876	1002020.....	311
1001562.....	870	1001833.....	476	1001918.....	870	1002021.....	311
1001563.....	870	1001834.....	476	1001919.....	870	1002022.....	311
1001564.....	870	1001835.....	476	1001920.....	872	1002023.....	304
1001565.....	870	1001836.....	476	1001921.....	872	1002024.....	304
1001566.....	870	1001841.....	477	1001922.....	872	1002025.....	304
1001568.....	873	1001847.....	477	1001923.....	872	1002026.....	800
1001569.....	873	1001848.....	477	1001924.....	474	1002027.....	800
1001570.....	873	1001849.....	477	1001925.....	474	1002028.....	800
1001571.....	874	1001850.....	477	1001926.....	474	1002029.....	303
1001572.....	874	1001851.....	477	1001927.....	474	1002030.....	303
1001573.....	874	1001855.....	683	1001930.....	462, 705	1002032.....	663
1001574.....	869	1001856.....	683	1001931.....	462, 705	1002033.....	663
1001575.....	869	1001857.....	228	1001932.....	462, 705	1002034.....	663
		1001858.....	228	1001933.....	462, 705	1002035.....	661
1001600		1001859.....	823, 848	1001934.....	705	1002036.....	661
1001633.....	604	1001860.....	393	1001937.....	589	1002037.....	661
1001634.....	604	1001861.....	392	1001938.....	589	1002041.....	654
1001635.....	604	1001862.....	396	1001939.....	241	1002045.....	080
1001636.....	604	1001863.....	396	1001940.....	053	1002046.....	080
1001637.....	605	1001864.....	396	1001941.....	053	1002047.....	049
1001638.....	605	1001865.....	346	1001942.....	053	1002048.....	362
1001642.....	606	1001866.....	346	1001943.....	053	1002049.....	362
1001643.....	606	1001867.....	346	1001944.....	053	1002050.....	362
1001644.....	606	1001868.....	387	1001945.....	053	1002051.....	260
1001645.....	606	1001869.....	387	1001950.....	067	1002052.....	260
1001647.....	107	1001870.....	387	1001951.....	067	1002053.....	127
1001648.....	107	1001871.....	351	1001952.....	067	1002054.....	127
1001676.....	010	1001872.....	351	1001962.....	597	1002055.....	127
1001677.....	010	1001873.....	351	1001963.....	597	1002056.....	127
1001678.....	010	1001874.....	388	1001964.....	588	1002057.....	127
1001691.....	130	1001875.....	388	1001965.....	588	1002058.....	127
1001692.....	130	1001876.....	388	1001968.....	400	1002059.....	127
		1001877.....	094, 250, 321	1001969.....	641	1002066.....	223
1001700		1001878.....	095, 251	1001970.....	641	1002067.....	223
1001701.....	062	1001879.....	095, 251	1001971.....	811	1002068.....	012
1001756.....	879	1001880.....	095, 291	1001972.....	800	1002069.....	643
1001778.....	534	1001881.....	094, 250, 321	1001973.....	514	1002070.....	643
1001796.....	761	1001882.....	094, 250, 321	1001974.....	514	1002071.....	643
1001797.....	761	1001883.....	095, 251, 321	1001975.....	514	1002072.....	282
1001798.....	761	1001884.....	095, 251, 321	1001976.....	514	1002073.....	282
1001799.....	761	1001885.....	095, 251, 321	1001978.....	491	1002074.....	282
		1001886.....	095, 251, 321	1001980.....	482	1002075.....	312
1001800		1001887.....	095, 251, 321	1001981.....	482	1002076.....	312
1001800.....	761	1001888.....	095, 251, 321	1001982.....	482	1002077.....	312
1001801.....	761	1001889.....	096, 252	1001989.....	491	1002082.....	823, 853
1001802.....	761	1001890.....	097, 253	1001990.....	491	1002097.....	822
1001803.....	761	1001891.....	097, 253	1001991.....	491	1002098.....	466, 710
1001804.....	761	1001892.....	097, 253	1001992.....	491	1002099.....	466, 710
1001805.....	761	1001893.....	096, 252	1001993.....	491		
1001806.....	760	1001894.....	096, 252	1001994.....	482		

1002100 466, 710	1002190..... 212	1002594..... 474	1002696..... 424
1002101..... 466, 710	1002191..... 212	1002596..... 474	1002697..... 429
1002102..... 466, 710	1002192..... 212	1002597..... 641	1002698..... 429
1002103..... 466, 710	1002193..... 123	1002598..... 500	1002699..... 429
1002104..... 479	1002194..... 123, 687	1002599..... 500	
1002105..... 479	1002195..... 190		1002700 429
1002106..... 479	1002196..... 123	1002600 500	1002701..... 429
1002107..... 479	1002197..... 123	1002601..... 500	1002702..... 429
1002108..... 479	1002198..... 580	1002602..... 428	1002703..... 429
1002109..... 479	1002199..... 580	1002603..... 428	1002704..... 429
1002110..... 390	1002200 581	1002604..... 428	1002705..... 429
1002111..... 390	1002201..... 590	1002605..... 647	1002785..... 852
1002113..... 390	1002202..... 590	1002606..... 647	1002791..... 852
1002116..... 208	1002203..... 590	1002607..... 207	1002792..... 852
1002117..... 208	1002204..... 455	1002608..... 207	
1002118..... 208	1002205..... 455	1002610..... 386	1002800 852
1002119..... 208	1002206..... 455	1002611..... 386	1002803..... 852
1002120..... 449	1002207..... 455	1002612..... 386	1002809..... 334
1002122..... 203	1002208..... 455	1002631..... 339	1002810..... 334
1002123..... 878	1002209..... 455	1002632..... 339	1002811..... 334
1002124..... 878	1002210..... 455	1002633..... 339	1002812..... 334
1002125..... 878	1002211..... 455	1002634..... 339	1002813..... 334
1002126..... 878	1002213..... 185	1002637..... 341	1002814..... 334
1002127..... 878	1002215..... 267, 284	1002638..... 341	1002815..... 334
1002128..... 875	1002216..... 267	1002639..... 341	1002816..... 334
1002131..... 155	1002217..... 044	1002640..... 341	1002817..... 334
1002132..... 310, 825	1002218..... 849	1002641..... 341	1002818..... 334
1002133..... 310, 825	1002220..... 849	1002642..... 341	1002819..... 334
1002134..... 310, 825	1002221..... 849	1002643..... 341	1002820..... 334
1002135..... 868	1002222..... 213	1002644..... 341	1002822..... 877
1002136..... 056	1002228..... 213	1002645..... 341	1002828..... 877
1002137..... 057	1002229..... 518	1002646..... 341	1002838..... 120
1002138..... 057	1002232..... 761	1002647..... 341	1002839..... 120
1002139..... 057	1002236..... 761	1002648..... 341	1002842..... 157
1002140..... 205	1002237..... 154	1002649..... 341	1002843..... 157
1002141..... 783	1002238..... 169	1002650..... 341	1002844..... 157
1002142..... 783	1002239..... 169	1002651..... 341	1002845..... 341
1002143..... 787	1002240..... 040	1002652..... 341	1002847..... 031
1002144..... 787	1002264..... 040	1002653..... 341	1002848..... 031
1002145..... 029	1002265..... 040	1002654..... 341	1002849..... 121
1002146..... 029	1002400 624	1002655..... 341	1002850..... 121
1002147..... 146	1002402..... 625	1002656..... 341	1002854..... 395
1002148..... 146	1002403..... 027	1002657..... 341	1002855..... 194
1002149..... 146	1002404..... 027	1002658..... 341	1002856..... 194
1002150..... 029	1002405..... 027	1002659..... 341	1002857..... 451
1002151..... 404	1002409..... 839	1002660..... 341	1002858..... 067, 322, 824
1002152..... 404	1002411..... 820	1002661..... 337	1002859..... 197
1002153..... 404	1002420..... 518	1002662..... 337	1002860..... 225
1002154..... 675	1002422..... 519	1002663..... 334	1002867..... 688
1002155..... 644	1002423..... 855	1002664..... 334	1002868..... 632
1002157..... 679	1002424..... 855	1002665..... 334	1002869..... 632
1002158..... 576	1002425..... 855	1002666..... 334	1002870..... 578
1002159..... 038	1002430..... 208	1002667..... 335	1002871..... 578
1002160..... 038	1002431..... 208	1002668..... 335	1002873..... 389
1002161..... 038	1002432..... 208	1002669..... 335	1002874..... 389
1002162..... 038	1002434..... 539	1002670..... 335	1002875..... 389
1002163..... 040	1002500 648	1002671..... 335	1002876..... 344
1002164..... 040	1002503..... 649	1002672..... 335	1002877..... 344
1002165..... 040	1002504..... 649	1002673..... 335	1002878..... 344
1002167..... 036	1002505..... 649	1002674..... 335	1002879..... 508
1002168..... 037	1002558..... 039	1002675..... 335	1002880..... 508
1002169..... 072	1002562..... 039	1002676..... 335	1002881..... 509
1002170..... 072	1002563..... 039	1002677..... 335	1002882..... 099, 255
1002171..... 073	1002564..... 039	1002678..... 335	1002884..... 688
1002172..... 073	1002582..... 011	1002686..... 363	1002885..... 508
1002173..... 205	1002583..... 011	1002688..... 425	1002886..... 508
1002174..... 177	1002584..... 285	1002689..... 425	1002887..... 509
1002175..... 286	1002585..... 285	1002690..... 425	1002888..... 508
1002185..... 719	1002591..... 474	1002691..... 847	1002889..... 508
1002186..... 719	1002592..... 474	1002692..... 847	1002890..... 101
1002187..... 725	1002593..... 474	1002693..... 847	1002891..... 101
1002188..... 722		1002694..... 424	1002892..... 848
1002189..... 717		1002695..... 424	1002893..... 733

1002895.....	733	1002976.....	297	1003054.....	257
1002897.....	733	1002977.....	297	1003055.....	257
1002898.....	733	1002978.....	297	1003057.....	489
1002899.....	733	1002979.....	440	1003058.....	489
1002900		1002980.....	440	1003059.....	489
1002900.....	660	1002981.....	440	1003060.....	489
1002902.....	660	1002982.....	445	1003061.....	489
1002903.....	689	1002983.....	445	1003062.....	489
1002904.....	689	1002984.....	445	1003063.....	489
1002905.....	670	1002985.....	225	1003064.....	489
1002906.....	577	1002986.....	225	1003067.....	490
1002907.....	577	1002987.....	225	1003068.....	490
1002909.....	103	1002989.....	638	1003069.....	490
1002910.....	103	1002990.....	639	1003070.....	490
1002911.....	103	1002991.....	574	1003071.....	524
1002912.....	103	1002992.....	574	1003072.....	524
1002913.....	103	1002993.....	145	1003073.....	525
1002914.....	103	1002994.....	822	1003074.....	524
1002915.....	140	1002995.....	822	1003075.....	525
1002917.....	140	1002996.....	801	1003076.....	527
1002918.....	140	1002997.....	801	1003077.....	527
1002919.....	140	1002998.....	801	1003078.....	527
1002920.....	188	1002999.....	801	1003079.....	527
1002921.....	188	1003000		1003080.....	527
1002922.....	445	1003001.....	579	1003081.....	527
1002925.....	144	1003002.....	079	1003083.....	525
1002926.....	144	1003003.....	079	1003084.....	525
1002927.....	144	1003004.....	079	1003085.....	879
1002928.....	157	1003005.....	079	1003087.....	872
1002929.....	157	1003006.....	079	1003088.....	872
1002930.....	157	1003007.....	079	1003090.....	877
1002931.....	177	1003008.....	510	1003091.....	880
1002932.....	177	1003009.....	510	1003092.....	880
1002933.....	177	1003010.....	510	1003093.....	877
1002934.....	264	1003011.....	511	1003094.....	872
1002935.....	264	1003012.....	511	1003095.....	872
1002936.....	264	1003013.....	511	1003096.....	880
1002937.....	069	1003014.....	325	1003097.....	878
1002938.....	069	1003015.....	325	1003098.....	879
1002939.....	069	1003016.....	325	1003099.....	880
1002940.....	313	1003017.....	324	1003100	
1002941.....	313	1003018.....	324	1003100.....	879
1002942.....	195	1003019.....	324	1003101.....	870
1002943.....	195	1003024.....	336	1003102.....	868
1002944.....	236	1003025.....	336	1003104.....	851
1002945.....	236	1003026.....	336	1003105.....	851
1002946.....	083	1003027.....	336	1003106.....	849
1002947.....	083	1003028.....	022	1003107.....	131
1002948.....	056	1003029.....	022		
1002949.....	057	1003030.....	018		
1002950.....	057	1003031.....	018		
1002951.....	057	1003032.....	020		
1002952.....	639	1003033.....	020		
1002953.....	639	1003034.....	193		
1002954.....	639	1003035.....	193		
1002955.....	639	1003036.....	457		
1002956.....	569	1003037.....	457		
1002957.....	569	1003038.....	457		
1002958.....	569	1003039.....	457		
1002959.....	569	1003040.....	257		
1002960.....	223	1003041.....	257		
1002961.....	223	1003042.....	257		
1002962.....	164	1003043.....	257		
1002964.....	164	1003044.....	105		
1002965.....	264	1003045.....	105		
1002967.....	241	1003046.....	105		
1002968.....	241	1003047.....	105		
1002969.....	297	1003048.....	107		
1002970.....	297	1003049.....	107		
1002971.....	297	1003050.....	107		
1002973.....	297	1003051.....	107		
1002974.....	297	1003052.....	257		
1002975.....	297	1003053.....	257		

1000926 114

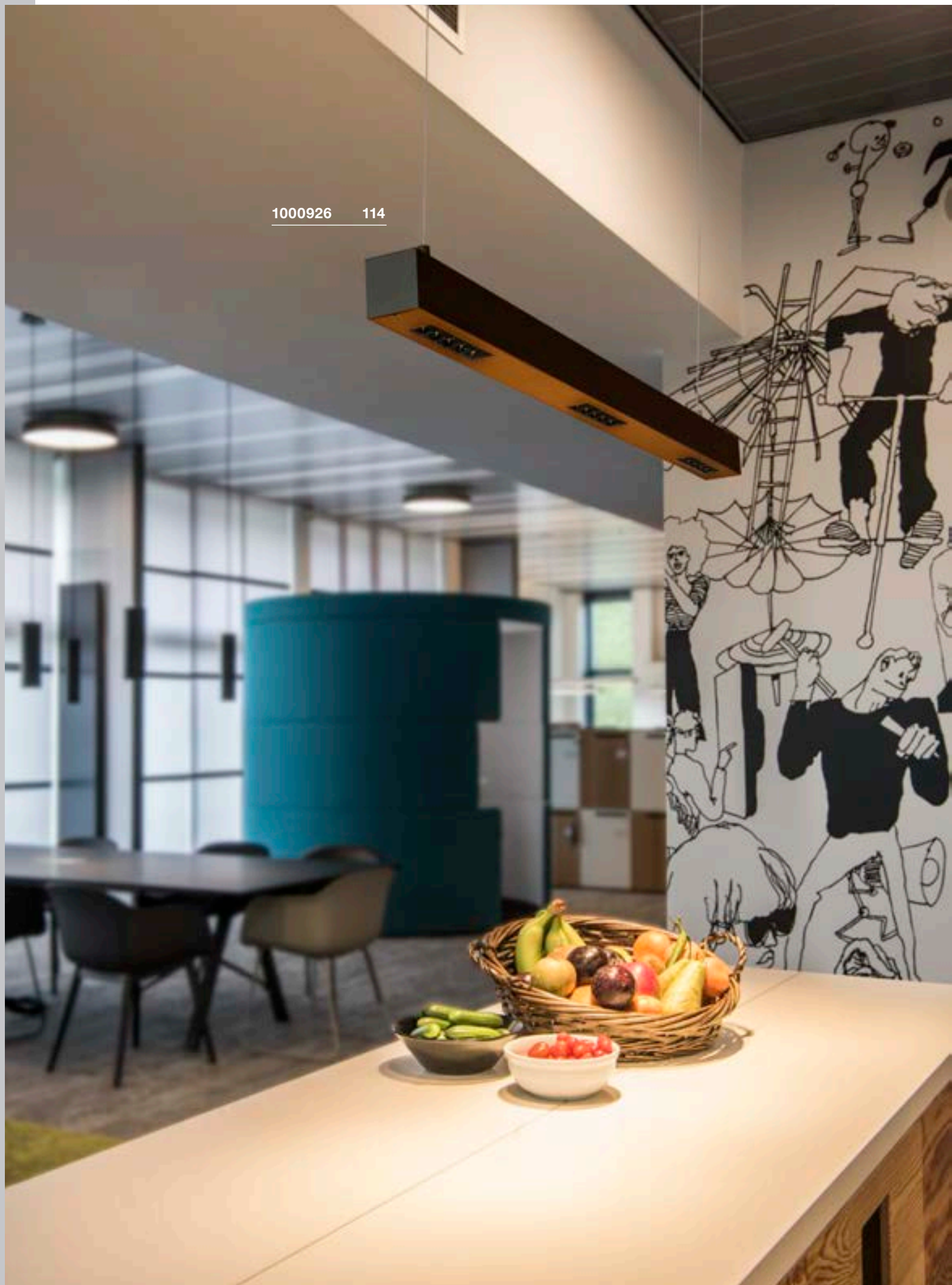

1-CIRCUIT

1-CIRCUIT SURFACE MOUNTED TRACK.....	404
1-CIRCUIT SURFACE MOUNTED TRACK accessories.....	405
1-CIRCUIT RECESSED TRACK.....	402
1-CIRCUIT RECESSED TRACK accessories..	402

2-CIRCUIT

D-TRACK®	
D-TRACK® 2-CIRCUIT TRACK.....	380
D-TRACK® 2-CIRCUIT TRACK accessories....	381

3-CIRCUIT

3-CIRCUIT RECESSED TRACK.....	373
3-CIRCUIT RECESSED TRACK accessories..	373

EUTRAC®

EUTRAC® 3-CIRCUIT SURFACE MOUNTED TRACK	369
EUTRAC® 3-CIRCUIT SURFACE MOUNTED TRACK accessories	370, 371

S-TRACK

S-TRACK 3-CIRCUIT SURFACE MOUNTED TRACK	365
S-TRACK 3-CIRCUIT SURFACE MOUNTED TRACK accessories	367
S-TRACK 3-CIRCUIT SURFACE MOUNTED TRACK DALI.....	339
S-TRACK 3-CIRCUIT SURFACE MOUNTED TRACK DALI accessories	341

A

ABRIDOR 60/100 Pole.....	574
ABRIDOR SENSOR WL.....	639
ABRIDOR WL	638
ACCANTO CL, E27	236
ACCANTO PD, E27	083
ACCANTO SPOT SQUARE WL, E27	194
ACCANTO WL, E27	195

ACCESSORIES

1-10V Dimmer 10W	849
4-way garden socket	862, 863
Cable.....	859
Cable clamp	858
Cable extension	860, 861
Ceiling hook.....	858
Ceiling plate	859
COMPENSATION MODULE.....	852
Connection box	864
Connection box 4-way	864
DALI Controller 24V DC.....	849
DALI Interface 0-10V + on/off.....	849
DALI Universal dimmer 3-25W.....	849
DALI Universal dimmer 10-300W.....	849
Double-sided adhesive tape.....	861
Energie-Pack 230V	864
GU10 Socket.....	860
GU10 Socket with connection box and quick terminal	860
LED Driver 320mA 3W	856
LED Driver 350mA 10W	852
LED Driver 350mA 15W	852
LED Driver 350mA 3W	856
LED Driver 350mA 6W	852
LED Driver 350mA 9W	856
LED Driver 350mA incl. strain relief	856
LED Driver 500mA 15W	852
LED Driver 500mA 9W	856
LED Driver 700mA 10W incl. strain relief	853
LED Driver 700mA 11W incl. strain relief	857
LED Driver 700mA 3W incl. strain relief	857
LED Driver 700mA 40W incl. strain relief	853
LED Driver 700mA 40W incl. strain relief	857
LED Driver 700mA 6W	852
LED Driver 1000mA	853
LED Driver 1000mA 40W incl. strain relief	857
LED Driver 1050mA 40W incl. strain relief	853
LED Driver DALI 250-700mA 20W	855
LED Driver DALI 250-700mA 40W	855
LED Driver DALI 350-1050mA 60W	855
LED Driver DALI 700-1500mA 50W	855
LED Driver VALETO® 1050mA	857
LED power supply 12V/24V DC 12W.....	850

LED power supply 12V/24V DC 12W round.....	850
LED power supply 12V/24V DC 20W.....	850
LED power supply 24V 100W.....	850, 851
LED power supply 24V 50W.....	851
LED power supply 24V DC 100W.....	850, 851
LED power supply 24V DC 150W.....	851
LED power supply 24V DC 20W.....	851
LED power supply 24V DC 36W.....	850
LED power supply 24V DC 60W.....	850
Motion sensor infra-red	865
Multway connector 3 outputs	860, 861
Multway connector 6 outputs	860, 861
Nepro Display tube kit	861
PWM Transformer 12V DC 24V DC	849
SLV cable H05RN-F	865
SLV cable H07RN-F	865
SLV VALETO® 12/24V Strip control module CCT	848
SLV VALETO® 12/24V Strip control module RGBW	848
SLV VALETO® 15W, LED Driver	853
Stopper for wire cable	859
T-connector box.....	864, 865
Textile cable 3-pin, 3 x 0,75 mm ² , 10 m.....	859
Textile cable 3-pin, 3 x 0,75 mm ² , 5 m.....	859
Transformer 12V AC 10VA IP44	846
Transformer 12V AC 60VA	848
Transformer 12V AC 60VA	848
Transformer 12V AC 60VA IP44	846
Transformer 12V AC 105VA	846
Transformer 12V AC 150VA	848
Transformer 12V AC 210VA	848
Transformer 12V AC 300VA	846
Transformer TENSEO 12V AC 50VA.....	847
Transformer TENSEO 12V AC 105VA.....	847
Transformer TENSEO 12V AC 210VA.....	847
TRIAC LED Driver 700mA 39W incl. strain relief	853
Wire cable suspension	859

ADEGAN FL, E27	540
ADEGAN MANILA FL, E27	539
ADEGAN MANILA PD, E27.....	533
ADI EL	700
ADJUST 135 EL, square/round, QPAR51	721
ADJUST 190 EL, square/round, QR111.....	721
ADJUST 265 EL, round, HIT-CE	721
AINOS CW.....	680

AIXLIGHT®

AIXLIGHT® 150 PD, R2 Office, TR C	117
AIXLIGHT® PD, R2, double, QPAR111	118
AIXLIGHT® PD, R2, quad, QPAR111	118
AIXLIGHT® PRO 50 LED module	500
AIXLIGHT® PRO 50 QPAR51 module.....	500
AIXLIGHT® PRO EL, COB LED module..	502, 503
AIXLIGHT® PRO EL, QPAR111 module.....	501
AIXLIGHT® PRO accessories.....	500, 501

AKALO D83 EL, TRIAC	464
ALAMEA EL	515
ALMINO PD, double, UGR<19	123
ALMINO PD, quad, UGR<19.....	123, 687
ALMINO WL, UGR<19	190
ALPA CONE 100 Pole, E27	548
ALPA MUSHROOM 45/75 Pole, E27	549
ALTRA DICE CL, QPAR51	267
ALTRA DICE CW, double, QPAR51.....	267, 284
ALTRA DICE TRACK 1-circ., QPAR51.....	395
ALTRA DICE TRACK 3-circ., QPAR51.....	343
ALTRA DICE WL, QPAR51	185
ANDREAS WL, QT-DE12.....	144
ANELA CL	265
ANELA Display.....	227
ANELA PD, TRIAC	074
ANGOLUX SENSOR WL	641
ANGOLUX SOLAR WL	641
ANGOLUX WL	641
ANILA EASYTEC® II, QPAR51	412
ANINDA 60 EL	517
ANINDA 120 EL	517
APONI 90/120 Pole, TRIAC.....	549
APONI WL, TRIAC	617
ARLINA 60 WL	169
ARLINA 60 WL, T16.....	169
ARLINA 130 WL	169
ARLINA 130 WL, T16.....	169
AROSA PD, 1,25 m, TRIAC.....	053
AROSA PD, 2m, TRIAC	053
ARROCK ARC Pole, QPAR51.....	562
ARROCK GRANITE 40/70 Pole, square, E27 ..	561

ARROCK SLOT Pole, QPAR51	570
ARROCK STONE 50/70 Pole.....	570
ASMARA LV, QR-C51	420
ASSO 70 WL	166
ASSO 300 WL	167
ASSO WL	167
ASTINA CL	264
ASTINA PD, QPAR51	069
ASTINA STEEL WL	655
ASTINA STEEL WL, QPAR51.....	655
ASTINA UP/DOWN WL, QPAR51	177
ASTINA WL, QPAR51.....	654
ASTO CW, single, QPAR51.....	301
ASTO CW, double, QPAR51	301
ASTO CW, triple, QPAR51	301
ASTO CW, quad, QPAR51.....	301
ASTO TUBE CW, single, QPAR51.....	295
ASTO TUBE CW, double, QPAR51	295
ASTO TUBE CW, triple, QPAR51	295
AVENTO 30 PD.....	055
AVENTO 110 PD	055
AVO CW, single, QPAR51.....	299
AVO CW, double, QPAR51	299
AVO CW, triple, QPAR51	299
AVO CW, quad, QPAR51	299
AVO TRACK 1-circ., QPAR51	387
AVO TRACK 3-circ., QPAR51	343

B

BASKET WL, E27	145
BATO 35 CW, E27.....	139
BATO 35 CW, TRIAC.....	139
BATO 35 PD, E27	058
BATO 35 PD, TRIAC.....	058
BATO 45 CW	238
BATO 45 CW, E27.....	238
BATO 45 PD, E27	059
BATO 45 PD, TRIAC.....	058

BATTEN LED

BATTEN LED 220-240V ~50/60Hz	815
BATTEN LED 220-240V ~50/60Hz accessories.....	815

BEDSIDE EL, left.....	446
BEDSIDE EL, right.....	446
BELA 40 PD	061
BELA 60 PD	061
BENA 120 CW	327
BENA 150 CW	327
BENDO 80/220 Pole, TRIAC	572
BENDO WL, TRIAC.....	636
BIBA PD, E14	077
BIG NAILS 50/80 Pole.....	552
BIG NAILS 50/80 Pole, E27.....	552
BIG NAILS PLUS 50/80 Pole, E27	551
BIG NAILS WL, E27	619
BIG NAUTILUS SP, round, QPAR51.....	588
BIG PLOT Cover, 2 slots	715
BIG PLOT Cover, 4 slots	715
BIG PLOT Modules	714, 715
BIG QUAD UP/DOWN WL.....	659
BIG QUAD WL	183, 646
BIG THEO CL	678
BIG THEO CL, QPAR111	678
BIG THEO BEAM UP/FLOOD DOWN WL	666
BIG THEO FLOOD UP/DOWN WL	666
BIG THEO UP/DOWN WL, QPAR111	665
BIG THEO WL.....	651
BIG THEO WL, QPAR111.....	650
BILAS CW, single, TRIAC	288
BILAS TRACK 1-circ., TRIAC	398
BILAS TRACK 3-circ., TRIAC	349
BIMA 1-circ., single, QPAR51	391
BIMA 3-circ., double, QPAR51	391
BIMA EASYTEC® II, single, QPAR51	411
BIMA 2 EASYTEC® II, double, QPAR51	411
BIMA 3-circ., single, QPAR51	351
BIMA 3-circ., double, QPAR51	351
BISHADE FL, E27	024
BISHADE PD, E27.....	082
BISHADE TL, E27	024

SLV BLUETOOTH® CONTROL

Dimmer wall installation, TRIAC	835
---------------------------------------	-----

BOOKAT Pole, TRIAC.....	564
BOX UP/DOWN WL, QT-DE12	662
BOX-L WL	661
BOX-L WL, E27	661

BRENDA PD, TRIAC.....	080
BRENDA TL, Wireless charging.....	015
BRENDA WL.....	142
BRICK DOWNUNDER EL.....	698
BRICK DOWNUNDER EL, E14.....	698
BRICK EL, asymmetrical.....	701
BRICK EL, symmetrical.....	701
BRICK MESH EL.....	701
BULAN CW, E14.....	682
BULAN GRID CW, E27.....	682

C

C-POL Pole, E27.....	555
C-POL WL, E27.....	618
CARISO WL.....	172
CHROMBO WL.....	162

SLV COLOR CONTROL

Bluetooth® Adapter.....	830
Remote control.....	829
FLEXLED ROLL MULTICOLOUR RGBW, 24V.....	830
FLEXLED ROLL MULTICOLOUR RGBW 24V accessories.....	830
Master controller with remote control.....	829
Signal amplifie.....	830
Slave controller.....	829
Wall control panel, recess-mounted/ surface-mounted.....	829

COMET LED LV.....	425
COMET LV, QR-C51.....	425
COMMO PD, TCR-TSE.....	077
CONE FL, E27.....	543
CONTONE® EL, round/square, rigid, TRIAC.....	457
CONTONE® EL, round/square, adjustable, TRIAC.....	457

SLV CONTROL BY TRUST

Internet control station ICS 2000.....	838
IP56 connection housing, 3-channel.....	840
Radio receiver module, 3-channel.....	840
Recessed radio multi-dimmer.....	840
Recessed radio switch.....	840
Remote control, 16-channel.....	838
Wall switch 1-way.....	838
Wireless socket switch BE/FR Indoor.....	839
Wireless socket switch BE/FR Outdoor.....	839
Wireless socket switch Indoor.....	839
Wireless socket switch IT.....	839
Wireless socket switch Outdoor.....	839
Wireless socket switch UK.....	839

COSMIC LV, QR-C51.....	421
COUPA FLEX WL.....	196
COUPA WL, QT14.....	197
CRYSTAL EL, TRIAC.....	449
CUBIX FL, QPAR51.....	542
CV SPOT SP, short.....	593
CV SPOT SP, long.....	593

D**DASAR®**

DASAR® 70 EL, square, QPAR51.....	729
DASAR® 80 EL, square/round, QPAR51.....	729
DASAR® 100 PREMIUM EL, round.....	727
DASAR® 100 PREMIUM EL, square.....	726
DASAR® 150 PREMIUM EL, round.....	727
DASAR® 150 PREMIUM EL, square.....	727
DASAR® 215 EL, round, E27.....	730
DASAR® 215 EL, square/round, QPAR111.....	730
DASAR® 218 EL, QR111.....	730
DASAR® 255 EL.....	733
DASAR® 270 EL, asymmetrical.....	733
DASAR® 270 EL, symmetrical.....	733
DASAR® 370 EL, square/round.....	723
DASAR® 920 EL.....	725
DASAR® EL, T16.....	734
DASAR® EXACT 116 EL, square/round, QPAR51.....	729
DASAR® FLAT 80 EL.....	722
DASAR® PROJECTOR SP, 12-24V.....	598
DASAR® PROJECTOR SP, 230V.....	598

DEKLED EL.....	450
----------------	-----

DELFD

DELFD D, 24V.....	813
DELFD D, 24V accessories.....	813

DELO WL.....	633
DELWA WL.....	183, 652
DENA 30 WL, E14.....	145
DEVIN WL, double.....	212
DINGILO EL, round, adjustable, TRIAC.....	457
DIO FLEX PLATE WL.....	208
DIO FLEX PLATE WL QPAR51.....	207
DISPLAY.....	229
DISPLAY ADL 50 QPAR51.....	225
DL 126 EL.....	450
DOLIX OUT EL, round, QPAR51.....	461, 707
DOLIX OUT EL, round, QR-C51.....	460, 706
DOLIX OUT EL, square, QPAR51.....	461, 707
DOLIX OUT EL, square, QR-C51.....	460, 706
DORISA 20, square.....	216
DORISA 30.....	215
DORISA 40, rectangular.....	216
DORISA 50.....	215
DOWNUNDER OUT, round.....	632
DOWNUNDER OUT, square.....	632
DOWNUNDER OUT S EL.....	699
DOWNUNDER OUT M EL.....	699
DOWNUNDER OUT L EL.....	699
DOWNUNDER PUR 80 EL.....	441
DOWNUNDER PUR 120 EL.....	441
DOWNUNDER PUR 150 EL.....	441

E**EASYTEC® II**

EASYTEC® II TRACK.....	415
EASYTEC® II TRACK accessories.....	415

ENOLA

ENOLA B CL, QPAR51.....	265
ENOLA B CW, single, QPAR51.....	289, 290
ENOLA B CW, double, QPAR51.....	289, 290
ENOLA B PD, QPAR51.....	070, 399
ENOLA B TRACK 1-circ., QPAR51.....	390
ENOLA B WL, QPAR51.....	177, 204
ENOLA C CL.....	266, 675
ENOLA C CL.....	675
ENOLA C CL, TRIAC.....	675
ENOLA C Pole.....	577
ENOLA C TRACK 1-circ.....	397
ENOLA C TRACK 3-circ.....	346
ENOLA C UP/DOWN WL.....	656
ENOLA C WL.....	628
ENOLA PD, E27.....	071

ESKINA 30/80 Pole.....	577
ESKINA D Display.....	670
ESKINA SPOT/SPOT SENSOR CW.....	689
EURO CUBE 3-circ.....	353
EURO SPOT TRACK 1-circ.....	392
EURO SPOT TRACK 1-circ. QPAR111.....	393
EURO SPOT TRACK 1-circ. QPAR51.....	392
EURO SPOT TRACK 3-circ.....	361
EURO SPOT TRACK 3-circ., DALI, 173 mm ..	335
EURO SPOT TRACK 3-circ., DALI, 235 mm ..	334
EURO SPOT TRACK 3-circ., DALI, 255 mm ..	334
EURO SPOT TRACK 3-circ., QPAR111.....	360
EURO SPOT TRACK 3-circ., QPAR51.....	360
EURO SPOT TRACK 3-circ., TRIAC.....	361

F

F-POL Pole, E27.....	555
F-POL WL, E27.....	618

FENDA

FENDA BOW BASIS FL, E27.....	022
FENDA Ceiling plate, E27.....	234
FENDA FL, E27.....	018, 020
FENDA Glass shade.....	044
FENDA Half-shade.....	148
FENDA Ø 15 cm, round.....	018, 020, 046
FENDA Ø 20 cm, round.....	192
FENDA Ø 30 cm, round.....	019, 021, 047, 235
FENDA Ø 40 cm, round.....	022, 044
FENDA Ø 45 cm, round.....	019, 021, 022, 047, 235
FENDA Ø 70 cm, round.....	019, 021, 047, 235
FENDA PD, E27.....	044

FENDA TL, E27.....	018, 020
FENDA WL, basic, E27.....	148, 192
FENDA WL, E27.....	193

FERA 25 CL.....	241
FERA 25 CL, DALI.....	241
FILI Terminal WL, QPAR51.....	224
FILI Canopy WL, QPAR51.....	224
FITU CW, E27.....	285
FITU FL, E27.....	029
FITU PD, E27.....	036, 037, 038, 039
FITU TL, E27.....	010
FITU WL, E27.....	146
FLAC BEAM® SP.....	605
FLAT FRAME BASIC EL, QT9.....	444
FLAT FRAME CURVE EL, QT9.....	443
FLATT 65/100 Pole.....	569
FLATT SENSOR WL.....	639
FLATT WL.....	639

FLEXLED ROLL

FLEXLED ROLL MULTICOLOUR RGBW, 24V.....	810, 830
FLEXLED ROLL MULTICOLOUR RGBW, 24V accessories.....	810, 830
FLEXLED ROLL RGB, 24V.....	811
FLEXLED ROLL SELECT, 24V.....	797
FLEXLED ROLL SELECT, 24V accessories.....	797
FLEXLED ROLL, 24V.....	799, 805, 812
FLEXLED ROLL, 24V accessories.....	799, 805
FLEXLED STRIP, 24V.....	800, 801
FLEXSTRIP LED HIGH LUMEN, 24V.....	803
FLEXSTRIP LED HIGH LUMEN 24V accessories.....	803
FLEXSTRIP LED RGB, 24V.....	809
FLEXSTRIP LED RGB 24V accessories.....	809

FLOOD LIGHT 25 SP.....	606
FLOOD LIGHT 32 SP.....	606
FORCHINI 40 PD, E27.....	062
FORCHINI 50 PD, E27.....	062
FORCHINI 70 PD, E27.....	062
FORCHINI M 40 TRACK 1-circ., E27.....	401
FORCHINI M 40 TRACK 3-circ., PD, E27.....	363
FORCHINI M 40 PD, E27.....	065
FORCHINI M 50 PD, E27.....	065
FRAME BASIC EL.....	444
FRAME BASIC EL, HV.....	444
FRAME BASIC SET EL.....	451
FRAME CURVE EL.....	443
FRAME CURVE EL, HV.....	443

G

GALEN 100 SP.....	609
GALEN SP, TRIAC.....	609
GIMBLE IN 68 EL.....	508
GIMBLE IN 100 EL.....	508
GIMBLE IN 150 EL.....	508
GIMBLE IN 175 EL.....	509
GIMBLE OUT EL.....	720
GLASSA CW, round, E27.....	317
GLASSA CW, square, E27.....	317

GLENOS®

GLENOS® Corner profile 272.....	768
GLENOS® Corner profile 2720 accessorie.....	769
GLENOS® Linear recessed profile 250.....	767
GLENOS® Linear recessed profile 250 accessories.....	767
GLENOS® Linear profile 110.....	764
GLENOS® Linear profile 1107 accessorie.....	765
GLENOS® PD, 1 m, 1-10V.....	112
GLENOS® PD, 2 m, 1-10V.....	112
GLENOS® Professional recessed profil 8832.....	774
GLENOS® Professional recessed profil 8832 accessories.....	775
GLENOS® Professional profile 202.....	776
GLENOS® Professional profile 202 accessories.....	777
GLENOS® Professional profile 303.....	770
GLENOS® Professional profile 303 accessories.....	771
GLENOS® Professional profile 497.....	772
GLENOS® Professional profile 497 accessories.....	773
GLENOS® 60.....	219

GLOO PURE 27/44/70 Pole, E27 548
 GLOO PURE WL, E27 614

GLU-TRAX®

GLU-TRAX® Track 433
 GLU-TRAX® Track accessories 433

GRAFIT 30/60 Pole, E27 557
 GRAFIT WL, E27 620

GRAZIA

GRAZIA 10 Accessories 750, 751
 GRAZIA 10 Recess-mounted profil 749
 GRAZIA 10 Surface-mounted profile, fl 749
 GRAZIA 10 Surface-mounted profile standard 749
 GRAZIA 20 Accessories 755, 756, 757
 GRAZIA 20 Recess-mounted profil 754
 GRAZIA 20 Surface-mounted profile, fl 753
 GRAZIA 20 Surface-mounted profile standard 753

H

H-LIGHT EL, oval, TRIAC 458
 H-LIGHT EL, round, TRIAC 458
 H-LIGHT EL, TRIAC 459
 H-POL 30/60 Pole 566
 H-POL Twin 30/60 Pole 567

H-PROFIL

H-PROFIL 2 m 759
 H-PROFIL 2 m accessories 760, 761

HANG UP 120 PD, TRIAC 108
 HELIA 30 PD 072
 HELIA 30 PD, TRIAC 073
 HELIA 40 PD 072
 HELIA 40 PD, TRIAC 073
 HELIA 50 TRACK 1-circ. 397
 HELIA 50 TRACK 3-circ. 346
 HELIA 50 TRACK EASYTEC® II 410
 HELIA CW, single, TRIAC 292, 691
 HELIA CW, double, TRIAC 292, 691
 HELIA EL 447
 HELIA Pole, single, TRIAC 580, 583
 HELIA Pole, double, TRIAC 581, 583
 HELIA SENSOR Single 580
 HELIA SPOT S SP, single, TRIAC 599
 HELIA SPOT L SP, single, TRIAC 599
 HELIA UP/DOWN WL, TRIAC 653
 HELIA WL, TRIAC 629
 HORN EL, QPAR51 473
 HORN MAGNA EL 474
 HORN MEDI EL 474
 HORN MINI EL 474
 HORN-A EL, QPAR51 471
 HORN-O EL, QPAR51 471
 HORN-T EL, QPAR11 472
 HORN-T EL, QPAR51 471

I

I-PENDANT PRO PD, 1195x295 mm, UGR<19, 1-10V 107
 I-PENDANT PRO PD, 1195x295 mm, UGR<22, 1-10V 106
 I-PENDANT PRO PD, 1195x295 mm, 1-10V.. 107
 I-PENDANT PRO PD, 1195x295 mm, DALI... 107
 IMPERVA 120 CW 687
 IMPERVA 150 CW 687
 INDA CW, QPAR51 283
 INDI REC EL, QPAR51 451
 IPERI 50 Pole 575
 IPERI WL 642
 IVED GOOSE WL, canopy 209

K

KADUX EL, single, 1-10V 499
 KADUX EL, single, QPAR111 497
 KADUX EL, single, QPAR51 496
 KADUX EL, single, TRIAC 498
 KADUX EL, double, 1-10V 499
 KADUX EL, double, QPAR111 497
 KADUX EL, double, QPAR111 496
 KADUX EL, double, TRIAC 498
 KADUX EL, triple, QPAR51 496
 KADUX EL, triple, TRIAC 498

KAHOLO EL, E27 452
 KALU CW, single, QPAR111 304
 KALU CW, single, TRIAC 306
 KALU CW, double, QPAR111 304
 KALU CW, double, TRIAC 306
 KALU CW, triple, QPAR111 304
 KALU CW, triple, TRIAC 306
 KALU CW, quad, long, TRIAC 307
 KALU CW, quad, square, TRIAC 307
 KALU CW, quad, wide, TRIAC 307
 KALU FL, single, QPAR111 010
 KALU TRACK 1-circ., QPAR111 395
 KALU TRACK 1-circ., TRIAC 395
 KALU TRACK 3-circ., QPAR111 358
 KALU TRACK 3-circ., QR111 358
 KALU TRACK 3-circ., TRIAC 359
 KAMUELA ECO EL, round, TRIAC... 463, 711, 745
 KANO EASYTEC® II, QPAR51 412
 KARDAMOD CL, round, single, QPAR111 276
 KARDAMOD CL, round, double, QPAR111... 276
 KARDAMOD CL, square, single, QPAR111... 274
 KARDAMOD CL, square, single, QR111 275
 KARDAMOD CL, square, double, QPAR111 .. 274
 KARDAMOD CL, square, double, QR111 275
 KARPO 30 CW, single 205, 286
 KARPO 30 CW, single, TRIAC 286
 KARPO 30 EL 447
 KARPO FL 025
 KARPO TL 025
 KARPO UP/DOWN WL 177
 KARPO WL 205

KELVIN CONTROL

KELVIN CONTROL-STRIP, 24V 807, 834
 KELVIN CONTROL-STRIP, 24V accessories 807, 834

SLV KELVIN CONTROL

Bluetooth® Adapter 833
 KELVIN CONTROL-STRIP, 24V 834
 KELVIN CONTROL-STRIP, 24V accessories... 834
 Master controller with remote control 833
 Remote control 833
 Signal amplifie 833
 Slave controller 833
 Wall control panel, recess-mounted/surface-mounted 833

KENAI

KENAI Surface-mounted profil 762
 KENAI Surface-mounted profile accessorie .. 763

KENGA 17 TL 537
 KENGA 45 FL, E27 537
 KENKUA SPOT WL, E27 194
 KENKUA WL, E27 194
 KERAS ELT WL, E27 622
 KINI EL, TRIAC 705
 KIROCONE TL, E27 534

L**LAMPS**

LED A60 E27 876, 877, 878
 LED A60 E27, CCT 820, 876
 LED A60 E27, Mirrorhead, chrome 879
 LED A60 E27, Mirrorhead, gold 879
 LED A60 E27, RGBW 820, 876
 LED C35 E14 875
 LED Filament G9 868
 LED FRISBEE E27 877
 LED G125 E27 880
 LED G125 E27, Mirrorhead, gold 880
 LED G125 E27 880
 LED G95/G125 E27 880
 LED G95/G125 E27, smoked glass 880
 LED PAR30 E27 881
 LED PAR38 E27 881
 LED QPAR111 GU10 872, 873, 874
 LED QPAR111 GU10, CCT,
 SLV VALETO® 821, 872
 LED QPAR111 GU10, RGBW,
 SLV VALETO® 821, 872
 LED QPAR51 GU10 870, 871
 LED QPAR51 GU10, CCT,
 SLV VALETO® 820, 870
 LED QR111 G53 874, 875
 LED QR51 GU5.3 869
 LED QT-DE12 R7S 118 mm 868
 LED QT-DE12 R7S 78 mm 868

LED QT14 G9 868
 LED ST58 E27 879
 LED ST64 E27 879
 LED T32 E27 879
 LED T32 FILAMENT GU10 870
 LED T38 E27 877
 LED T45 E27 876, 877
 LED TCR-TSE GX53 881

LED PANEL 300x120 mm 525
 LED PANEL 600x600 mm 524, 525
 LED PANEL 620x620 mm 524, 525
 LED SAIL WL 173
 LED SPIKE SP 590

L-LINE 60 220
 L-LINE 120 220
 LASSON 10 PD, E27 084
 LASSON 45 PD, E27 084
 LASSON 80 PD, E27 085
 LASSON WL, E27 149

LED-STRIP

LED-STRIP, 24V 798
 LED-STRIP, 24V accessories 798

LENITO TRACK 3-circ. 345
 LENITO WL 188, 227
 LIGHT EYE® 90 TRACK EASYTEC® II,
 QPAR51 413
 LIGHT EYE® 90 1-circ., QPAR51 388
 LIGHT EYE® 90 CW, single, QPAR51 291
 LIGHT EYE® 90 CW, double, QPAR51 291
 LIGHT EYE® 90 PD, GU10 050
 LIGHT EYE® 150 TRACK 3-circ., QPAR51 344
 LIGHT EYE® 150 TRACK EASYTEC® II, PD,
 QPAR111 414
 LIGHT EYE® 150 TRACK EASYTEC® II,
 QPAR111 413
 LIGHT EYE® 150 3-circ., PD, QPAR111 363
 LIGHT EYE® 150 PD, QPAR111 050, 399
 LIGHT PIPE 60/90 PD, TRIAC 075
 LIGHT PIPE 60/90/140 Pole, TRIAC 028, 550
 LIGHTPOINT EL 448
 LIPA CW, TRIAC 683
 LIPSY® 30 CW, Dome 311
 LIPSY® 30 CW, Drum 312
 LIPSY® 30 CW, VALETO® 310, 825
 LIPSY® 40 CW, Dome 311
 LIPSY® 40 CW, Drum 312
 LIPSY® 40 CW, Drum, DALI 313
 LIPSY® 40 CW, VALETO® 310, 825
 LIPSY® 50 CW, Dome 311
 LIPSY® 50 CW, Drum 312
 LIPSY® 50 CW, Drum, DALI 313
 LIPSY® 50 CW, VALETO® 310, 825
 LISENNE 40/70 Pole, E27 546
 LISENNE CL, E27 673
 LISENNE PD, E27 076
 LISENNE TL, E27 541
 LISENNE WL, E27 143
 LOGS 40/70 Pole 558
 LOGS IN L WL 157
 LOGS IN L WL, TRIAC 157
 LOGS IN WL 156
 LOGS WL 664
 LONG GRILL CW 329
 LYNNAH PD, quad 119
 LYNNAH WL 184

M**M-TRACK**

M-TRACK Adjustable light 430
 M-TRACK Spot 430
 M-TRACK Track 431
 M-TRACK Track accessories 431

MAGANDA TL 012
 MAGANDA WL 210
 MALANG CL, E27 260
 MALANG CW, SLV VALETO® 067, 322, 824
 MALO Display WL 228
 MALU CL 679
 MALU Pole 576
 MALU WL 644
 MANA OUT WL 660
 MANA Shade 151, 153, 199
 MANA WL, Basic 198
 MANA WL, Basic, TRIAC 150, 152

MARONA CW, TRIAC.....	314
MARYLIN WL.....	212
MECANICA PLUS FL.....	027
MECANICA PLUS TL.....	027

MEDO

MEDO 30 CL, 1-10V.....	092, 248
MEDO 30 CL, TRIAC.....	090, 246
MEDO 30 CORONA CW, DALI.....	096, 252
MEDO 30 CORONA CW, TRIAC.....	094, 250, 321
MEDO 30 EL, Frame.....	520
MEDO 30 EL, Frameless.....	518
MEDO 40 CL, 1-10V.....	092, 248
MEDO 40 CL, TRIAC.....	091, 247
MEDO 40 CORONA CW, DALI.....	096, 252
MEDO 40 CORONA CW, TRIAC.....	095, 251, 321
MEDO 40 EL, Frame.....	520
MEDO 40 EL, Frameless.....	519
MEDO 60 CL, 1-10V.....	092, 248
MEDO 60 CL, Square.....	254
MEDO 60 CL, Square, 1-10V.....	098
MEDO 60 CL, Square, DALI.....	099, 255
MEDO 60 CORONA CW, DALI.....	096, 252
MEDO 60 CORONA CW, TRIAC.....	095, 251, 321
MEDO 60 EL, Frame.....	520
MEDO 60 EL, Frameless.....	519
MEDO 90 CL, 1-10V.....	093, 249
MEDO 90 CORONA CL, DALI.....	097, 253
MEDO 90 CORONA CL, TRIAC.....	095, 251
MEDO 90 EL, Frame.....	521
MEDO 90 EL, Frameless.....	519
MEDO RING 60 PD, DALI.....	101
MEDO RING 60 PD, 1-10V.....	100
MEDO RING 90 PD, 1-10V.....	100

MELAN CW, E27.....	316
MERADO FLOOD TRACK 3-circ., TRIAC.....	345
MERADO FLOOD WL.....	189
MERIDIAN BOX WL, E27.....	626, 627
MERIDIAN BOX WL, E27, MR.....	627
MERIDIAN WL, E27.....	623
MERVALED SENSOR WL.....	637
MERVALED WL.....	637
MIBO UP/DOWN WL, QT14.....	214
MILANDO 2 EL.....	479
MILANDO 5 EL.....	479
MILANDO 10 EL.....	479
MOBALA EL.....	445
MOLAT CL, E27.....	672
MOLAT PD, E27.....	532
MOLAT Pole, E27.....	550
MOLAT WL, E27.....	614
MOLDI 32 CW.....	315
MOLDI 46 CW.....	315
MOLDI 46 CW, Sensor.....	315
MYRA CW, single, QPAR51.....	690
MYRA WL, double, QPAR51.....	690
MYRA DISPLAY WL, curved, QPAR51.....	671
MYRA DISPLAY WL, straight, QPAR51.....	671
MYRA SPOT Double, GU10.....	583
MYRA UP/DOWN WL, QPAR51.....	653

N

NAGY 75 CL, QPAR51.....	264
NAPIA TWIN WL.....	200
NAPIA WL.....	200
NAUTILUS 10 SP, round, QPAR51.....	588, 589
NAUTILUS 10 SP, square.....	589
NAUTILUS 10 SPOT SP, QPAR51.....	597
NAUTILUS 10 WL, square.....	689
NAUTILUS 25 CL.....	688
NAUTILUS SP.....	597
NAUTILUS SP, QR-C51.....	595
NAUTILUS SPOT SP, PAR38, E27.....	597
NAUTILUS WL, square.....	689
NEPRO DISPLAY QT-DE12.....	228

NEW TRIA

NEW TRIA 45 Single, round, CS.....	488
NEW TRIA 45 Single, square, CS.....	488
NEW TRIA 68 Single, round, CS, TRIAC.....	490
NEW TRIA 68 Single, square, CS, TRIAC.....	490
NEW TRIA 68 Single, round, CS.....	489
NEW TRIA 68 Single, square, CS.....	489
NEW TRIA 68 Single, round, CS/LS, QPAR51.....	482
NEW TRIA 68 Single, square, CS/LS, QPAR51.....	482

NEW TRIA 68 Single, round, CS/LS, TRIAC.....	491
NEW TRIA 68 Single, square, CS/LS, TRIAC.....	491
NEW TRIA 77 Single, round, CS.....	492
NEW TRIA 77 Single, square, CS.....	492
NEW TRIA 78 Single, round, CS, QPAR51.....	485
NEW TRIA 78 Single, square, CS, QPAR51.....	485
NEW TRIA 78 Single, round, LS, QPAR51.....	484
NEW TRIA 78 Single, square, LS, QPAR51.....	484
NEW TRIA 110 Single, round, CS, TRIAC.....	494
NEW TRIA 110 Single, square, CS, TRIAC.....	495
NEW TRIA 150 Single, round, CS, 1-10V.....	495
NEW TRIA 150 Single, square, CS, 1-10V.....	495
NEW TRIA 150 Single, round, LS, QPAR111.....	487
NEW TRIA 150 Single, square, LS, QPAR111.....	487
NEW TRIA 155 Double, CS.....	493
NEW TRIA 155 Double, CS, QPAR51.....	486
NEW TRIA 300 Double, CS, QPAR111.....	487

LOW-VOLTAGE CABLE SYSTEM

LOW-VOLTAGE CABLE SYSTEM.....	428, 429
LOW-VOLTAGE CABLE SYSTEM accessories.....	429

NOBLO CW, single, TRIAC.....	297
NOBLO CW, double, TRIAC.....	297
NOBLO CW, triple, TRIAC.....	297
NOBLO SPOT 1-circ.....	396
NOBLO SPOT 1-circ., Triple Track Set.....	386
NOBLO SPOT 3-circ.....	346
NOBLO SPOT LV, Rope track.....	424
NOTAPO WL.....	440

O

OCCULDAS 13 DL, TRIAC.....	263
OCCULDAS 13 DL, indirect, TRIAC.....	262
OCCULDAS 13 MOVE DL, TRIAC.....	263
OCCULDAS 14 EL, indirect, TRIAC.....	469
OCCULDAS 14 MOVE EL, TRIAC.....	469
OCCULDAS 23 DL, indirect, TRIAC.....	263
OCCULDAS 23 EL, indirect, TRIAC.....	469
ONE 40 WL, DALI.....	140
ONE 60 PD, DALI.....	103
ONE 60 WL, DALI.....	140
ONE 80 PD, DALI.....	103
ONE TRIPLE PD, DALI.....	103
OPEN GRILL CW.....	329
OPEN GRILL PD, Single Twist.....	116
OPEN GRILL PD, Double Twist.....	116
ORDI SENSOR WL.....	640
ORDI WL.....	640
OSSA 180 WL, QT-DE12.....	168
OSSA 300 WL, QT-DE12.....	168
OTOS GLAS Pole, E27.....	547
OUT 65 EL, round, TRIAC.....	708
OUT 65 EL, square, TRIAC.....	708
OUT-BEAM UP/FLOOD Down WL.....	669
OUT-BEAM UP/DOWN WL.....	668
OUT-BEAM UP/DOWN WL, QT-DE12.....	668
OUTDOOR BEAM 11 SP.....	604
OUTDOOR BEAM 22 SP.....	604
OUTDOOR BEAM 28 SP.....	605

P

P-LIGHT CL.....	742
P-LIGHT CW.....	740, 741, 743
PANEL 60 CL, round, DALI.....	257
PANEL 60 CL, round, TRIAC.....	256
PANEL 60 EL, round.....	522
PANEL 60 PD, 1-10V.....	104
PANEL 60 PD, round, DALI.....	105
PANEL CL, 1200x300 mm, DALI.....	257
PANEL CL, 1200x300 mm, TRIAC.....	257
PANTILO 16 PD, E27.....	079
PANTILO 20 PD, E27.....	079
PANTILO 28 PD, E27.....	079
PARA 380 PD, E27.....	128
PARA CONE 14 1-circ., PD, QPAR51.....	400
PARA CONE 14 1-circ., PD, QPAR51.....	389
PARA CONE 14 3-circ., PD, QPAR51.....	363
PARA CONE 14 3-circ., QPAR51.....	344
PARA CONE 20 PD, E27.....	066

PARA CONE 30 PD, E27.....	066
PARA CONE 40 PD, E27.....	066
PARA DOME E27.....	127
PARA DOME PD, E27.....	127, 129
PARA FLAC PD/CL.....	130
PARA FLAC PD/CL, DALI.....	131
PARA MULTI PD, DLMI.....	129
PATTA-F EL, round, TRIAC.....	465, 709
PATTA-F EL, square, TRIAC.....	465, 709
PATTA-I EL, round, TRIAC.....	466, 467, 710, 711
PATTA-I EL, square, TRIAC.....	466, 467, 710, 711
PAVANO 300x1200 mm.....	527
PAVANO 300x1200 mm.....	527
PAVANO 620x620 mm.....	527
PEMA® WL.....	184, 633, 643
PEMA® WL, E27.....	643
PHELIA FL, E27.....	026
PHELIA PD, E27.....	056, 057
PHELIA TL, QPAR51.....	026
PHELIA WL, QPAR51.....	203
PHOTONIA CL, E27.....	672
PHOTONIA PD, E27.....	532
PHOTONIA Pole, E27.....	547
PHOTONIA TL, E27.....	541
PHOTONIA WL, E27.....	614
Pictogram transparencies.....	740, 741, 743
PIKA EL, round, QPAR51.....	455
PIKA EL, round, QPAR51, rigid.....	454
PIKA EL, square, QPAR51, tilttable.....	455
PIKA EL, square, QPAR51, tilttable.....	455
PIPOFLEX WL.....	206

PLASTRA

PLASTRA 101 WL, E14.....	180
PLASTRA 104 CL, E27.....	240
PLASTRA 104 WL, QT14.....	174
PLASTRA 105 CL, E27.....	240
PLASTRA 15 CL, single, QPAR51.....	272
PLASTRA 25 CL, double, QPAR51.....	273
PLASTRA 25 PD, cone, TCR-TSE.....	048
PLASTRA 25 PD, round, TCR-TSE.....	049
PLASTRA 25 PD, TCR-TSE.....	049
PLASTRA 35 CL, triple, QPAR51.....	273
PLASTRA CL.....	240
PLASTRA CL, QPAR51.....	272
PLASTRA EL, round, QPAR51.....	453
PLASTRA EL, square, QPAR51.....	453
PLASTRA PD, QPAR51.....	070
PLASTRA UP/DOWN WL, curve.....	174
PLASTRA WL.....	137
PLASTRA WL, cone, TCR-TSE.....	180
PLASTRA WL, cube, QT14.....	155
PLASTRA WL, curve.....	170
PLASTRA WL, curve, QT-DE12.....	180
PLASTRA WL, QPAR51.....	159, 175
PLASTRA WL, rectangular, QT-DE12.....	154
PLASTRA WL, slot, E14.....	159
PLASTRA WL, square.....	137

POLE PARC 90/150/200 Pole.....	556
POLE PARC CL.....	675
POLE PARC UP/DOWN WL.....	657
POLE PARC WL.....	631
POWER TRAIL-LITE® EL, round.....	717
POWER TRAIL-LITE® EL, square.....	717
POWER-LED SPOT, GLU-TRAX®.....	432

PROFILE STRIP

PROFILE STRIP GRAND, 24V.....	787
PROFILE STRIP GRAND, 24V accessories.....	787
PROFILE STRIP SELECT, 24V.....	795
PROFILE STRIP STANDARD, 24V.....	782
PROFILE STRIP STANDARD, 24V accessories.....	783
PROFILE STRIP X-SLIM, 24V.....	793

PURI CW, single, QPAR51.....	303
PURI CW, double, QPAR51.....	303
PURI CW, quad, QPAR51.....	303
PURI CW, triple, QPAR51.....	303
PURI TRACK 1-circ., QPAR51.....	387, 388
PURI TRACK 1-circ., Triple Track Set.....	386
PURI TRACK 3-circ., QPAR51.....	350, 351
PURIA TRACK 1-circ., QPAR51.....	387
PURISA WL, E27.....	145

Q

Q-LINE® CL, 1 m, BAP.....	259
Q-LINE® CL, 2 m, BAP.....	259

Q-LINE® PD, 1 m, BAP, TRIAC	114
Q-LINE® PD, 2 m, BAP, TRIAC	114
Q-LINE® PD, DALI, single	113
Q-LINE® PD, single	113
Q-LINE® WL	221
QRB LV, QR111	423
QUAD Pole	579
QUAD UP/DOWN 12 WL	158, 658
QUAD UP/DOWN 15 WL	158, 658
QUAD WL	183, 646
QUADRASYL 75 Pole, TCR-TSE	575
QUADRASYL CW, TCR-TSE	645
QUADRASYL WL, TCR-TSE	645
QUADRULO SENSOR WL, E27	624
QUADRULO WL, E27	625

R

RASCALI 45/65 Pole	565
RASCALI WL	634
RASTO 120 CL, double	258
RASTO 125 CL, double	258
RASTO 150 CL, double	258
RASTO 155 CL, double	258
RENISTO S EL, round, housing, TRIAC	477
RENISTO S EL, square, housing, TRIAC	476
RENISTO M EL, round, housing, TRIAC	477
RENISTO M EL, square, housing, TRIAC	476
RENISTO L EL, round, housing, TRIAC	477
RENISTO L EL, square, housing, TRIAC	476
RETRATO WL	223
REVILO D-TRACK®	378
REVILO TRACK D-TRACK®	378
RILO EL	514
ROCCI EL, round	719
ROCCI EL, square	719
ROTOBALL 25 CL, E27	260
ROTOBALL 25/40 PD, E27	533
ROTOBALL 25/40/50 FL, E27	538
ROTOBALL 25/40/50 PD, E27	080
ROTOBALL 40 CL, E27	260
ROX ACRYL 30/60/90 Pole, E27	553
ROX ACRYL 30/60/90 Pole, TRIAC	553
ROX ACRYL CL, E27	676
ROX CL, GX53	676
ROX CL, QPAR111	266, 676
ROX UP/DOWN WL, QPAR111	178, 656
ROX WL, QPAR111	178, 630
RUBA 10/16/20 CW	681
RUBA 10/16/20 CW, Sensor	681
RUSTY® 40/70 Pole	545, 560
RUSTY® 40/70 Pole, E27	545, 560
RUSTY® CONE 40/70 Pole, E27	544
RUSTY® CONE FL, E14	544
RUSTY® PATHLIGHT 40/70 Pole	573
RUSTY® PATHLIGHT Pole, TCR-TSE	573
RUSTY® SLOT 50/80 Pole	571
RUSTY® SLOT 50/80 Pole, E27	571

S

SAIL WL	647
SALUNA LV, QR-C51	422
SEDO 14 WL	164
SEDO 21 WL	164
SEDO 7 WL	164
SENER 12 CW, round, TRIAC	325
SENER 12 CW, square, TRIAC	324
SENER 12 EL, round	510
SENER 12 EL, square	511
SENER 18 CW, round, TRIAC	325
SENER 18 CW, square, TRIAC	324
SENER 18 EL, round	510
SENER 18 EL, square	511
SENER 24 CW, round, TRIAC	325
SENER 24 CW, square, TRIAC	324
SENER 24 EL, round	510
SENER 24 EL, square	511
SHELL 15 WL, TRIAC	186
SHELL 30 WL, TRIAC	186
SIGHT 60 CW	328
SIGHT 115 CW	328
SIGHT TRACK 3-circ.	349
SIGHT TRACK 3-circ., DALI	337
SIGHT TRACK 3-circ., PD	362
SIMA CW, round, Sensor	319
SIMA CW, round, TRIAC	318
SIMA CW, square, Sensor	319
SIMA CW, square, TRIAC	319

SITRA 360 CW, TCR-TSE	690
SITRA 360 Pole, TCR-TSE	582
SITRA 360 SPIKE SP, single, TCR-TSE	591
SITRA 360 SPIKE SP, double, TCR-TSE	591
SITRA CL, TCR-TSE	674
SITRA CUBE WL	663
SITRA CUBE WL, TCR-TSE	663
SITRA UP/DOWN WL	654
SITRA UP/DOWN WL, TCR-TSE	654
SITRA WL	629
SITRA WL, TCR-TSE	629
SLOTBOX 40/70 Pole	568
SLOTS 45 Pole	563
SLOTS 65 Pole	563
SLOTS WL	616
SOLASTO EL, square/round	718
SOLID CUBE WL, QT14	155
SOLO 90° GLU-TRAX®, QR-C51	432
SOPRANA CL, E27	237
SOPRANA OVAL WL, E27	147
SOPRANA PD, E27	082
SOPRANA WL, E27	149
SPHERA 45 PD, TRIAC	068
SPHERA 75 PD, TRIAC	068
SPOODI 13 SP, SENSOR	603
SPOODI 15 SP	600
SPOODI 20 SP	601
SPOODI 20 SP, SENSOR	603
SPOODI 31 SP	603
SPOT 79 CW, QPAR51	283
SPOT CW, E27	282
SPOT DISPLAY E27	225
SPOT T 3-circ.	348
SPOT TRACK 1-circ., E27	388
SPOT TRACK 3-circ., E27	342
SQUARE C CL, E27	677
SQUARE CL, TRIAC	677
SQUARE Pole 30/60/90 Pole, TRIAC	559
SQUARE TURN WL, G9	657
SQUARE WL, E27	620
SQUARE WL, TRIAC	620
STIX WL	203
STRUCTEC 1-circ.	398
STRUCTEC 3-circ., R9	356
STRUCTEC 3-circ.	356
STRUCTEC 3-circ., DALI	336
STRUCTEC ZOOM 3-circ.	357
SUN / BIG SUN PD, E27	080
SUPROS 78 CL, TRIAC	277
SUPROS 78 EL, Move, TRIAC	505
SUPROS 78 EL, TRIAC	504
SUPROS 78 PD	124
SUPROS 78 TRACK 3-circ., TRIAC	354
SUPROS 78 Up/Down WL	179
SUPROS CL	277
SUPROS CL, Move	277
SUPROS EL	506
SUPROS EL, Move	507
SUPROS PD	125
SUPROS TRACK 3-circ.	355
SYNA SP	590
SYROS LV, QR-C51	421

T

TANI WL, QT-DE12	162
TEC KALU CL, double, TRIAC	268
TEC KALU CL, quad, TRIAC	268
TEC KALU TRACK 3-circ., double, TRIAC	352
TEC KALU TRACK 3-circ., double, TRIAC	352
TELESKOP LV, QR-C51	420
TENORA CL, E27	237
TENORA WL, E27	191
TERANG 200 CW	684
TERANG 270 CW	684
TERANG 270 CW Sensor	684
THEO CL, QPAR51	678
THEO PATHLIGHT Pole, single	578
THEO PATHLIGHT Pole, double	578
THEO UP/DOWN WL, QPAR51	161, 665
THEO WL, QPAR51	650
TODAY Display	670
TODAY PRO Display	670
TONGA® 1-circ., PD, E14	400
TONGA® EASYTEC® II, PD, E14	414
TONGA® PD, E14	077
TONILA TL	011
TOTHEE CW, TRIAC	287
TOTHEE D-TRACK®, TRIAC	378

TRAIL-LITE® 60 EL	716
TRAPECCO DOWN WL	644
TRAPECCO Pole	576
TRIADDEM PD, E27	083
TRILEDO CL, single, round	271
TRILEDO CL, single, round, QPAR51	269
TRILEDO CL, single, square	271
TRILEDO CL, single, square, QPAR51	269
TRILEDO CL, double, square	271
TRILEDO CL, double, square, QPAR51	270
TRUKKO 60/90 WL	211
TRUKKO WL	211
TRUST 30/60 Pole	551
TRUST WL	619

V**SLV VALETO®**

12/24V Strip control module CCT	823
12/24V Strip control module RGBW	823
15W, LED driver	823
Gateway	820
LIPSY® 30 CW, VALETO®	825
LIPSY® 40 CW, VALETO®	825
LIPSY® 50 CW, VALETO®	825
MALANG CW, SLV VALETO®	824
Phase cut dimmer	822
Remote control	822
Remote control, CCT/RGBW	822

VALETO® LED PANEL 595x595 mm	
UGR>19	523
VALETO® LED PANEL 620x620 mm,	
UGR<19	523
VANO WING SP, 1-10V	608
VAP 40/70/100 Pole, E27	554
VAP SLIM 30/60/90 Pole, E27	554
VARU EL	462, 705
VARU EL, QPAR51	462, 705
VERLUX EL, square, TRIAC	512, 513
VILUA L WL	649
VILUA S WL	648
VILUA UP/DOWN, WL	649
VINCELLI D PD, TRIAC	053
VINCELLI D TL	012
VINCELLI D WL	223
VISSARDO WL	210

W

WALLYX WL, QPAR51	635
WAVE 25 WL	171
WAVE 45 WL	171
WETSY EL, square/round	719
WILRON L SP	607
WILRON S SP	607
WL 106 E14	213
WL 149 WL	163
WL 149 WL, QT-DE12	163
WORKLIGHT FL	030
WORKLIGHT PD, DALI	120
WORKLIGHT PLUS FL, DALI	031
WORKLIGHT PLUS PD, DALI	121
WORO EL	445

Y

YOKI EASYTEC® II, QPAR111	412
---------------------------------	-----

1003007 79



1003003 79



NEW
PANTILO

1003005 79



1002873 57

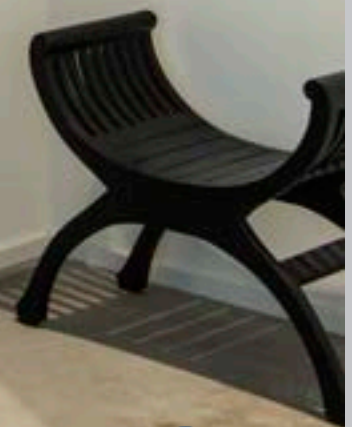

**NEW
VARIANT**
PARA CONE

NEW
DASAR®



1002893 733

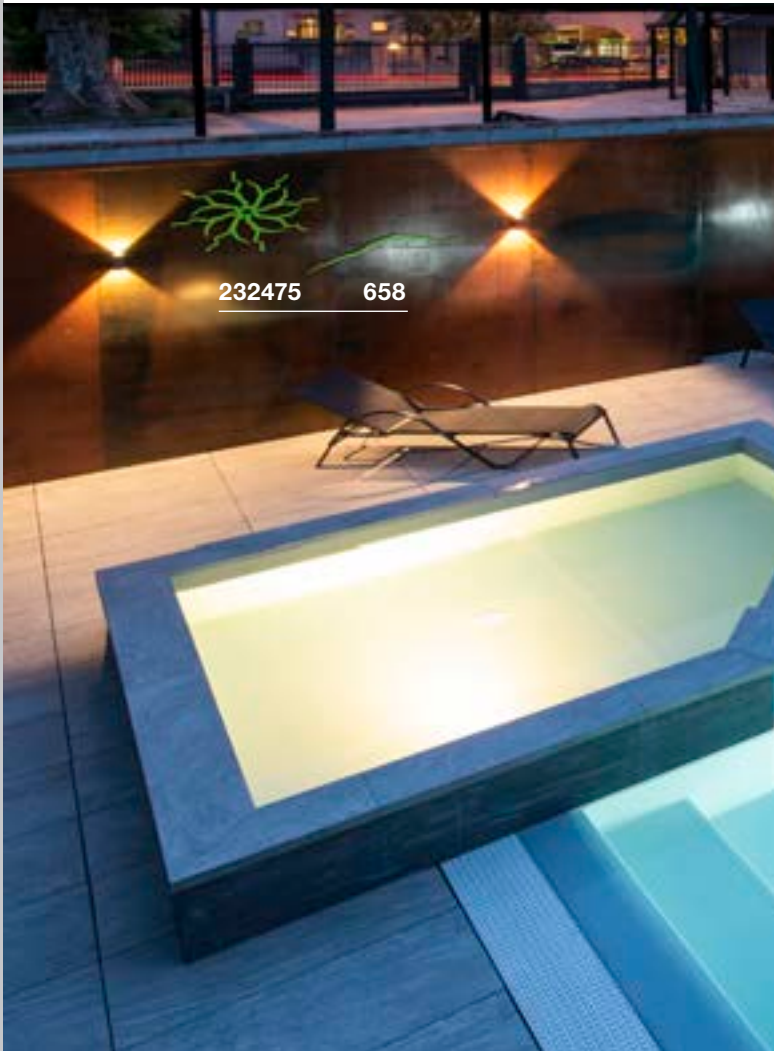

232475 658

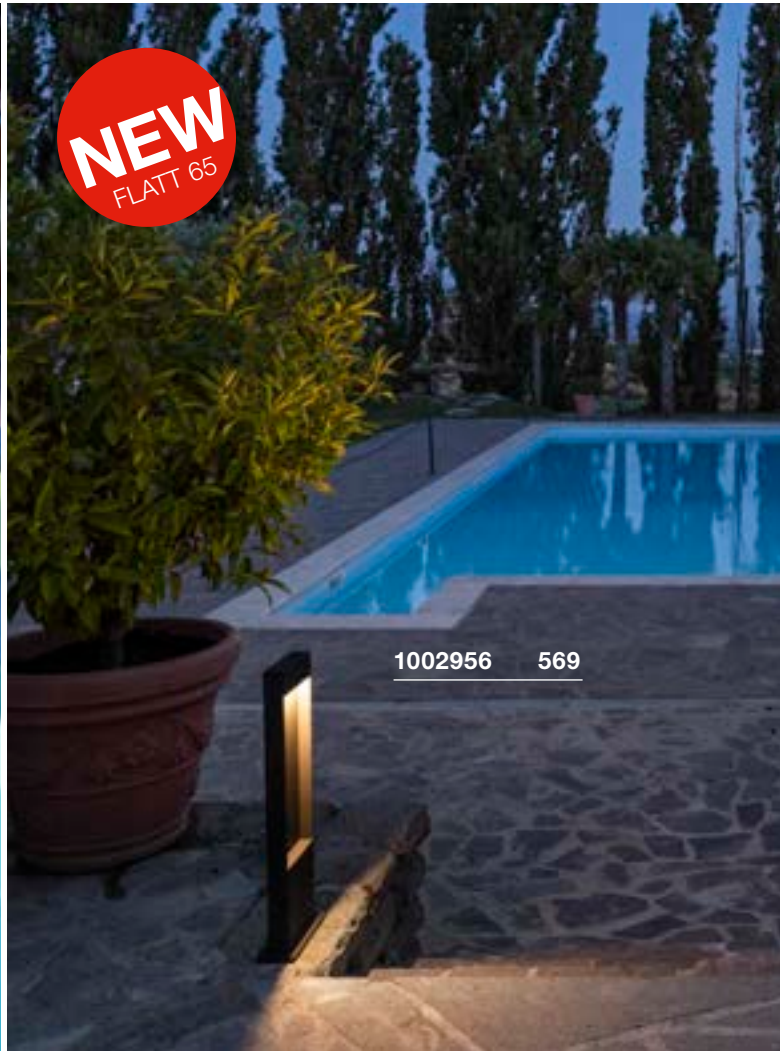

NEW
FLATT 65

1002956 569

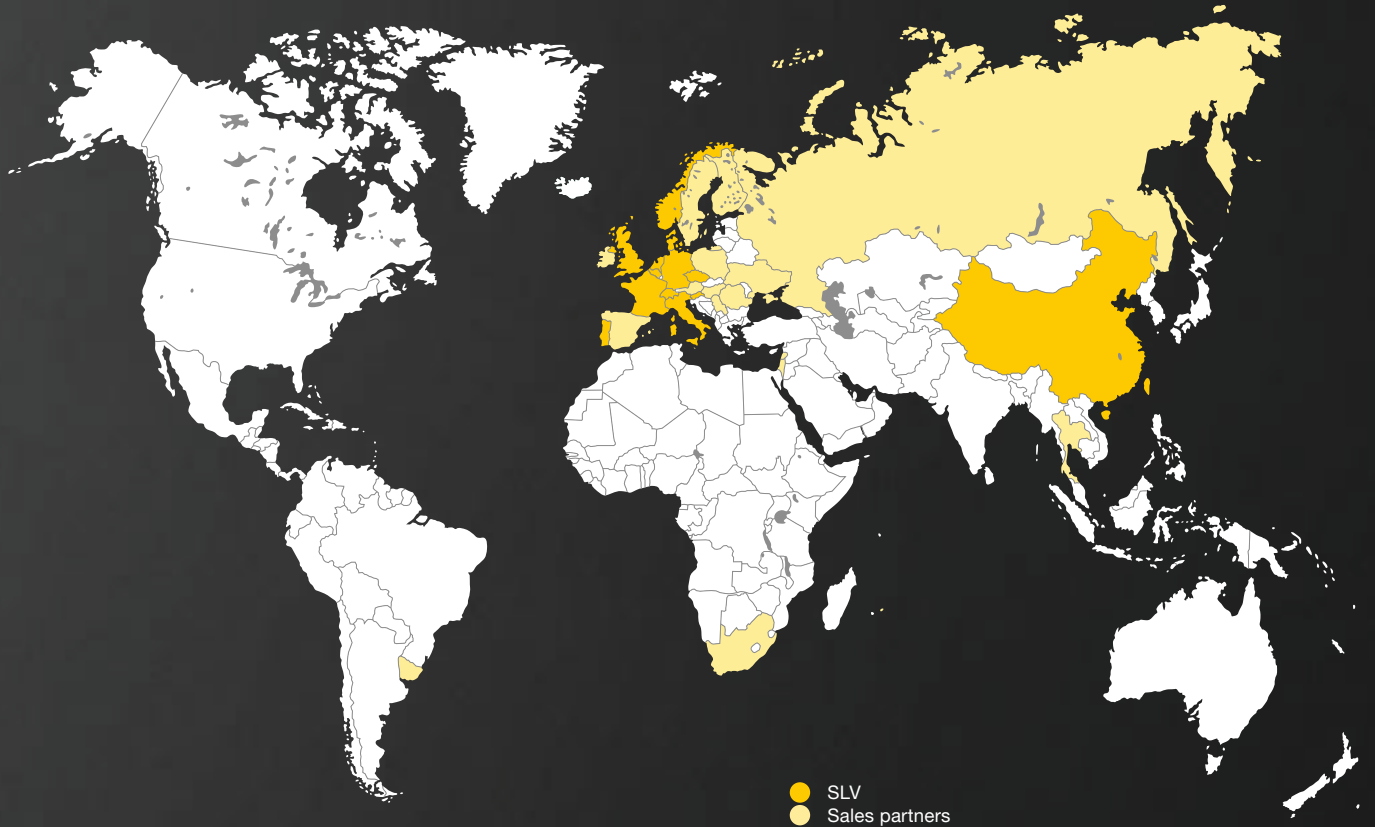

16

SUBSIDIARIES

19

SALES PARTNERS

SLV DELIVERS TO MORE THAN 100 COUNTRIES

WE ARE IN YOUR NEIGHBOURHOOD.

SUBSIDIARIES

- Asia
- Belgium
- Czech Republic
- Denmark
- France
- Great Britain
- Italy
- Netherlands
- Norway
- Portugal
- Slovenia
- Switzerland

SALES PARTNERS

- Austria
- Denmark
- Finland
- Hungary
- Ireland
- Israel
- Lebanon
- Malta
- Mauritius
- Poland
- Romania
- Russia
- Serbia
- South Africa
- Spain
- Sweden
- Thailand
- Ukraine
- Uruguay

PRODUCT CHARACTERISTICS

Energy efficiency index
 "This luminaire is compatible with lamps of energy efficiency indexes ..."



Luminaires with built-in LEDs
 "This luminaire contains built-in LED lamps. The lamps in the luminaire cannot be replaced." (see EU Regulation 874/2012)



"This luminaire contains built-in LED lamps. The lamps in the luminaire cannot be replaced." (see EU Regulation 874/2012)
Note for end users:
 The light source of this luminaire may only be replaced by the manufacturer or a service technician authorised by them.



Energy efficiency index
 of the ballast



Dimmable with ...

- C = trailing edge dimmer
- L = leading edge dimmer
- Uni = Universal dimmer
- Triac C = Triac trailing edge dimmer
- Triac L = Triac leading edge dimmer
- 1-10 V
- Dali = Dali bus system
- Switch = switch or button



Weight
 of the product in kg

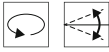

Rotatable and tiltable: Luminaire

- Rotation range
- Tilt range



Rotatable and tiltable: Lamp/lamp part

- Tilt range



The beam angle is measured at the angle where the light emitted diminishes to 50% intensity compared to the centre of the beam. The smaller the value, the greater the bundling.



Light outlet

- direct
- direct-indirect
- Beam
- Flood and Beam



Pendant length
 In cm for pendants

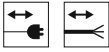

Connection lead length in cm
Feed-in cable length in cm (with open cable end)



Maximum cable separation
 for low-voltage cable systems in cm



Average life span of a lamp or a light source in hours



We would be happy to send you a light distribution graph for the product concerned on request.



Reflector lamps | direct mirror lamps (no cool beam):
 Heat load in the light bundle, therefore almost no heat radiation on the rear side of the reflector



Products marked as being remotely controllable

SPECIFIC DETAILS – RECESSED FITTINGS



Shape of recess opening



Heat development
 on the surface of the in-ground fitted spot



Weight bearing capacity of the product up to the specified value in tonnes. Measurements based on installations in concrete.

SAFETY INFORMATION



Protection class
 One Two Three



Short circuit-resistant safety operating device



Impact resistance of the product to the specified value in joules



The IK impact resistance code is a measure of the protection provided for electrical operating materials (equipment) against external loads by a housing (IK codes).

APPLICATION AREA INSTALLATION

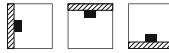

Installation area

- Wall
- Ceiling
- Ground / floor
- Wall / ceiling
- Wall / floor
- Ceiling / floor
- Wall / ceiling / floor

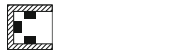
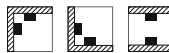

- Used **exclusively** indoors
- **Unsuitable** for use indoors
- IP protection class



Permits the device to be installed on materials whose flammability is not known.



- Lamp suitable for use in luminaires ...
- **with** protection glass
 - **without** protection glass



Cable diameter
 in mm

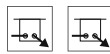

- Through-wiring ...**
- possible
 - possible to the number of luminaires indicated.



Independent converter
 (Operating device also for use outside of luminaires)

SPECIAL SYMBOLS



Identifies products with built-in LEDs



- Smart Home compatible**
- SLV VALETO module integrated
 - SLV VALETO capability with accessories



Indicates products which are appearing for the first time in this catalogue.



- Marks new variants of existing products**
- New colour variant
 - New product variant
 - Successor



Marks luminaires with a motion sensor (microwave system (MR) / infra-red / radio)



Dim to warm. The more the luminaire is dimmed, the warmer the light colour gets.



- **USB charging function**
- **Inductive (wireless) charging function** for Smartphones



Marks our HighLIGHTS lamps



Indicates products which can be combined to suit individual taste and atmosphere.



Luminaires can be painted over as desired with wall paint, or even wallpapered after they have been primed.



Indicates products which can be provided in individual lengths and completely assembled according to the customer's wishes.

CUSTOMER INFORMATION

Information about heat development on luminaire housings

Halogen bulbs operate at a high temperature and can cause their respective luminaire housings to heat up. The latter may therefore only be touched when they have cooled down. Adjustable luminaires or lamp heads which do not have insulated adjusting handles fitted or which are used with lamps at the maximum wattage meaning that the permitted maximum housing temperature is exceeded at the obvious adjustment point, must be installed out of arms' reach. Our LED retrofit lamps are available as a low temperature alternative for most of our halogen luminaires.

Luminous flux

The total amount of light which is generated by a light source, given in Lumen (lm).

Luminous intensity

The luminous intensity is the luminous flux per room angle specified, it is given in Candela (cd).

Colour rendering index

The colour rendering index of a light source is described using the Ra Index (Colour Rendering Index). For light sources used indoors, a CRI of 80 or higher is prescribed. Light sources for outdoor use must have a CRI of at least 65.

Light colour

The light colour of a light source is given in Kelvin (K).

Standard LED

This is the classic version of an LED (3 mm or 5 mm LED). These were originally designed for indication purposes, e.g. in instrument panels.

Standard SMD LED

SMD stands for Surface Mounted Device. It is a compact LED without wire connectors, rather with direct soldering onto the PCB. SMDs are available in various sizes and are well suited for illumination purposes.

PowerLED

A PowerLED is a powerful LED with 1W or more power. It places increased demands on the current stability and therefore has to be used with constant current sources. If multiple LEDs are connected, they must therefore be connected in series. Connecting in parallel is not permitted. Please also pay attention to the installation sequence so that LEDs are not exposed to high currents for short periods of time, since they could be damaged. In general, the following applies: First completely connect the secondary circuit (LEDs to the driver), then connect the primary circuit (driver to the power source).

Chip On Board LED (COB LED); Flat LEDs

These are LEDs with an extremely flat design. The advantage of COB LEDs is that they have good heat dissipation for technical implementation with cool surfaces, providing the possibility of high luminous efficiency with long service life.

Stainless steel 304

(1.4301) Has good corrosion resistance suited to natural environmental media (water, urban and rural atmospheres) without the presence of significant concentrations of chlorine and salt. However, 1.4301 is not suitable for usage areas in which it comes into contact with sea water, salt water or salt-laden atmospheres, nor is it suitable for use in swimming pools or the like.

Stainless steel 316

(1.4404) Has excellent corrosion resistance suited to natural environmental media (water, urban and rural atmospheres) as well as in industrial areas with moderate concentrations of chlorine and salt, in the food and pharmaceutical industries and in the agricultural food sector. 1.4404 is not sea water resistant.

Please note:

A large proportion of the products presented in this catalogue are protected by trademarks, registered design, industrial design or patents. Violation of these protective rights or the use of text and layout design and copyrighted pictures without our permission will be prosecuted. The illustrations and specifications contained within this catalogue are for illustration purposes only and are not binding in terms of colour, shape, design and technical specifications. No liability is therefore accepted for errors or changes in any of the product descriptions/information.

All products in our range are subjected to stringent quality assurance measures and meet all of the generally applicable standards. This catalogue contains a general range and is not designed to be country-specific. Any deviations from country-specific regulations must be clarified before an order is placed. SLV is not liable for any other technical standards, where applicable. All weight and length data specified are in kg or in cm, unless otherwise specified. We reserve the right to make technical changes!

The presentation of our luminaires with realistic and exemplary application photographs has been made possible by the friendly cooperation and agreement of the owner or designer of each property shown in the foreground of the pictures. Once again, we would like to take this opportunity to thank those who gave their permission for the photographs to be taken and used in this publication!

With the publication of this catalogue, the prices in other previously published lists and catalogues become invalid.

Publisher

SLV GmbH, Germany
Daimlerstraße 21-23
D-52531 Übach-Palenberg
T +49 (0) 2451 4833-355
slv.com

Copyright

© SLV GmbH, 2019

Photo credits

SLV GmbH
External photographers: Andreas Fein, Anja Lynen, Gerd Arnolds, Günther Preissler, Marc Derkum, Dirk Hoßmann



Innovative use of combined heat and power technology when printing this product reduced CO₂ emissions by up to 52% in comparison to conventional methods in Germany.

EcoVadis

EcoVadis is a well-known rating agency which evaluates corporate responsibility. A total of 150 purchasing categories and 21 CSR indicators are examined with the so-called CSR evaluation method (Corporate Social Responsibility). When doing this, the rating agency does not just examine environmental aspects but also adherence to employment law and human rights, as well as ethics and sustainable procurement. Since it was established in 2007, EcoVadis has become a valued and recognised partner for purchasing organisations in more than 300 of the world's leading multinational companies. SLV's result puts the company in the top 5 % of all companies participating in the assessment worldwide, and even in the top 2 % in its own industry.



EXPERIENCE LIGHT

SLV GmbH

Daimlerstrasse 21-23
D-52531 Uebach-Palenberg
Germany

T +49 (0) 2451 4833 - 355

F +49 (0) 2451 4833 - 179

export@slv.de

slv.com