



INDOOR

LIGHTING
HOGAR /
INTÉRIEUR 2015

© LOREFAR, 2015

Referencia/Reference/Référence:

A0237

Primera edición / First edition / Première édition:

Diseño catálogo / Catalogue designer / Conception du catalogue:

Fotografía / Photography / Photographie:

Impresión / Printed by / Imprimer:

Enero / January / Janvier 2015

Faro Barcelona (Joel Polls), Empiezapori Comunicació Gràfica i Web

Guillem FH

INGOPRINT

[E S S E N T I A L
L I G H T I N G]

**Join
us!**     
www.faro.es/blog

why us

We are a team consisting of people, with international and highly professional profiles, covering all phases of the lighting and fan business, from design and manufacturing to distribution. We offer a comprehensive and global “package deal”.

Somos un equipo de personas, con vocación internacional y alta profesionalidad, que cubre todas las fases del negocio de la iluminación y la ventilación, desde el diseño y la fabricación hasta la distribución, con una oferta integrada y global.

Nous sommes une équipe de professionnels à visée internationale et nous couvrons toutes les étapes du secteur du luminaire et de la ventilation, depuis la conception et la fabrication jusqu'à la distribution.

Siamo un gruppo di persone con vocazione internazionale, e alta professionalità, che coprono tutte le fasi dell'illuminazione e della ventilazione, dal disegno, alla fabbricazione, fino alla distribuzione, con una offerta integrata e globale.

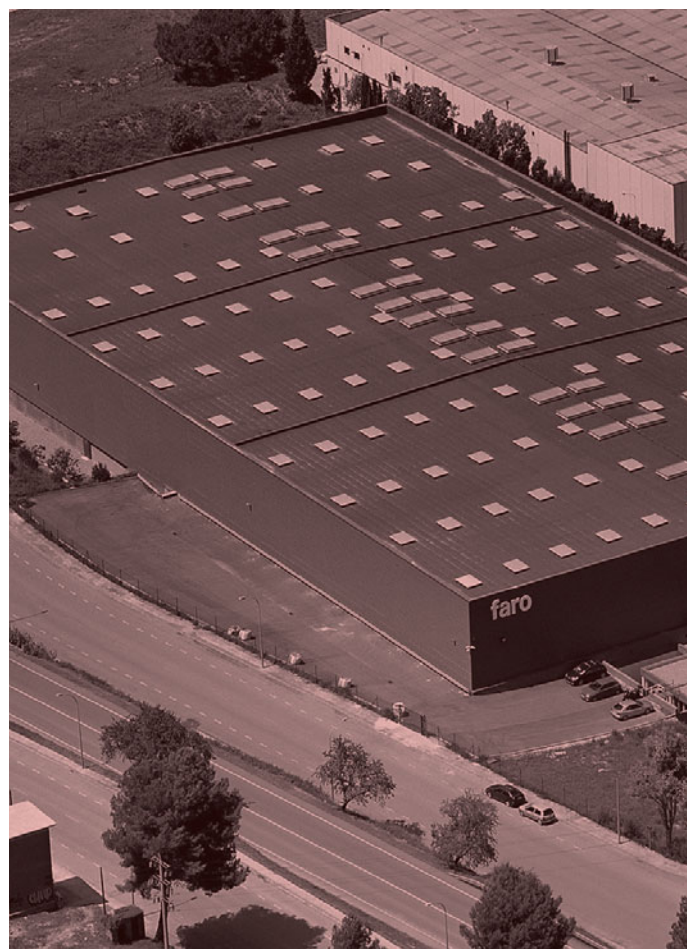

+90 Countries in which we operate.



Países en los que estamos presentes.

Pays dans lesquels nous sommes présents.

Paesi nei quali operiamo.



+3.000

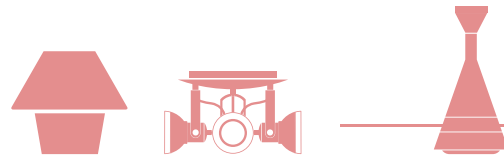

Lighting & fan solutions.

Soluciones en iluminación y ventilación.

Solutions en éclairage et illumination.

Soluzioni di illuminazione e ventilazione.

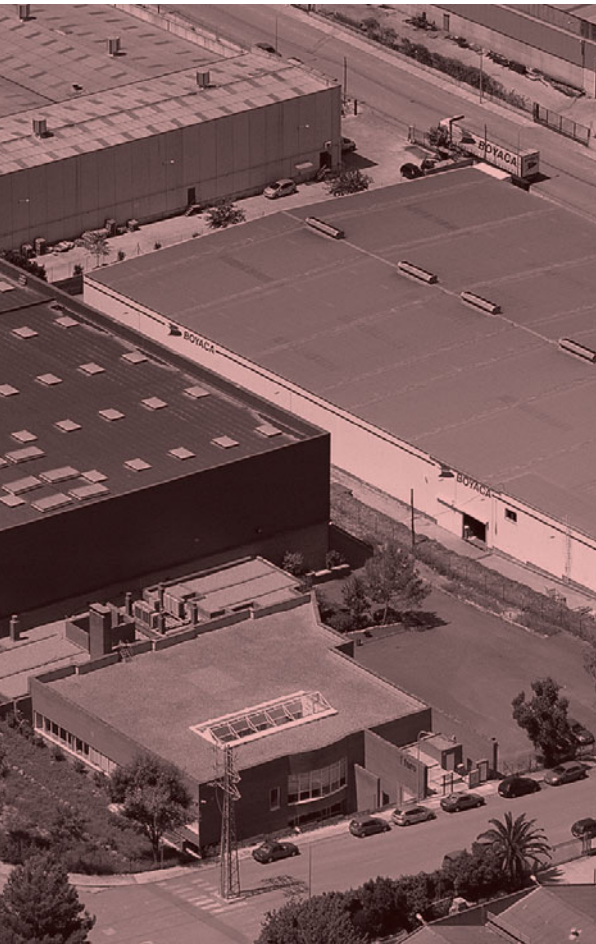

+60

Years experience.

Años de experiencia.

Ans d'expérience.

Anni di esperienza.

design ers

more than 350
registered products
ideas born in Barcelona.



**Faro
Team**



**Estudi
Ribaudí**



**Manel
Lluscà**



**Pepe
Llaudet**



Nahtrang



**Marina
Milà**



**Jordi
Llopis**



**Jordi
Busquets**

DESIGNER
DISEÑADOR
DESIGNER
DISEGNATORE

retRo

by Manel Lluscà

With '60s nostalgia and looking into the decoration of the decade, we created this series of floodlights, harking back to shapes and colours of a retro style.

Con la nostalgia de los 60 e investigando en la decoración de la década, hemos creado esta línea de luminarias, recordando formas y colores de un estilo retro.

Avec la nostalgie des années 60 et les recherches faites sur la décoration de cette décennie, nous avons créé une ligne de luminaires qui rappellent les formes et les couleurs de ce style rétro.



home lighting
catalogue
2015

20

[new] pendant lamp

- 20016  beige
beige
- 20017  olive green
verde oliva
- 20018  red
rojo

1 XE14 MAX 20W NOT INCL. [16239] [LED 17451]
METAL /
METAL

A++ to B / 100-240V - 50-60 Hz / 0.51 kg / 1.12 lb

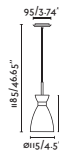

REFERENCE
REFERENCIA
RÉFÉRENCE
RIFERIMENTO

FINISH
ACABADO
FINITION
RIFINITURA

[new] floor lamp

- 20019  beige
beige
- 20020  olive green
verde oliva
- 20009  red
rojo

1 XE14 MAX 20W NOT INCL. [16239] [LED 17451]
METAL /
METAL

A++ to B / 100-240V - 50-60 Hz / 2.92 kg / 6.44 lb

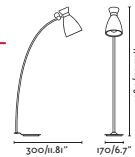

SIZES IN MM
MEDIDAS EN MM
DIMENSIONI IN MM

BULB &
COMSUMPTION
BOMBILLA Y
CONSUMO
AMPOULE ET
CONSOMMATION
LAMPADINA E
CONSUMO

ENGINE & DIFUSOR MATERIAL
MATERIAL DE LA ESTRUCTURA Y DEL DIFUSOR
MATÉRIEL DE LA STRUCTURE ET DU DIFUSSEUR
MATERIALE DEL DIFFUSORE E DELLA STRUTTURA

TECHNIQUE INFORMATION: CLASS, IP
INFORMACIÓN TÉCNICA: CLASE, IP
INFORMATION TECHNIQUE: CLASSE, IP
INFORMAZIONE TECNICA, CLASSE, IP

series
series
series
series

21

p_384 **FARO COMMITMENT**
COMPROMISO FARO
LENGAGEMENT FARO
IMPEGNO FARO

p_386 **IP**
IP
IP
IP

p_388 **SYMBOLS**
SÍMBOLOS
SYMBOLLES
SIMBOLI

p_390 **MATERIALS**
MATERIALES
MATÉRIAUX
MATERIALI



more info

p_392 **FINISHES**
ACABADOS
FINITIONS
RIFINITURE

p_394 **GENERAL INFORMATION**
INFORMACIÓN GENERAL
INFORMATIONS GÉNÉRALES
INFO GENERALE

WALL LAMPS

APLIQUES
APPLIQUES
LAMPADE DA PARETE

				[new] 					
áLAmo p_189	Ally p_219	aMbo p_232	áNgulo p_243	auRea p_215	biRd p_228	blAt p_185	boReal p_179	bugAtti p_224	caLda p_319
					[new] 				
ceLia p_219	chEras p_238	cOde p_229	conO p_241	crEta p_74	dAllas p_231	dAta p_246	diuLa p_246	dokA p_323	dRaco p_193
						[new] 			
eAco p_237	eQui p_246	eRis p_177	fEXi p_52	gaLAXia p_180	geNaker p_242	giGi p_61	giNa p_231	grOe p_235	hEnri p_217
								[new] 	
homS p_231	hoTel p_32	ibiScus p_243	ikOn p_315	iNdo p_327	kaPa p_221	laMpetta p_65	laoS p_321	laRa p_85	lAss p_327
			[new] 						
linDa p_47	liNk p_50	liRia p_244	liSe p_67	loKe p_223	luNe p_200	miKa p_186	miLD p_315	miTic p_81	miX p_40
								[new] 	[new] 
miX p_41	mOma p_71	náPoles p_104	neRis p_225	nlger p_325	nuDos p_103	Ola p_247	oRa p_69	osLo p_235	oVo p_227
								[new] 	
pEtra p_219	porTos p_245	raY p_225	reLax p_325	retRo p_23	riNg p_173	rlo p_86	roDa p_217	rOom p_211	sAba p_91
		[new] 			[new] 	[new] 			
saBana p_213	sAc p_98	sAmi p_221	siNki p_217	siNtra p_245	sirEt p_317	sNow p_235	sTar p_195	sunNy p_247	swEet p_37

[new]



swiNg
p_214



teRma
p_319



tHana
p_77



tiMe
p_319



toRino
p_107



tuB
p_221



tubA
p_183



tuRbo
p_199



Twin
p_240



veRa
p_243

[new]



veSper
p_31



vOlta
p_27



wiNch
p_97



yUri
p_175

CEILING FIXTURES

PLAFONES
PLAFONNIER
PLAFONIERE

[new]



acaCia
p_269



adrA
p_266



aMi
p_265



aSpa
p_278



aZor
p_273



bODen
p_331



clEan
p_329



clOe
p_328



coCcote
p_57



coPic
p_259

[new]



cOra
p_330



daNte
p_269



dAta
p_268



dinO
p_269



dRaco
p_193



fuJi
p_265



halCón
p_272



ibiScus
p_271



jaNet
p_262



kaLO
p_276

[new]

[new]



KaO
p_329



lEni
p_265



liChi
p_261



liRia
p_271



loGos
p_333



luNe
p_201



mArlin
p_63



miKa
p_187



nAn
p_259



náPoles
p_105

[new]

[new]

[new]

[new]

[new]

[new]

[new]



pOte
p_263



reL
p_260



retRo
p_25



riNg
p_173



ronDa
p_267



sQuad
p_256



sTar
p_197



teCto
p_254



tEd
p_337



tiDa
p_270

[new]



tOd
p_337



tOla
p_335



tubA
p_183



veRa
p_267



yUca
p_268 y 329

SUSPENDED

COLGANTES
SUSPENSIONS
SOSPENSIONI

									
áAmo p_191	aldEr p_163	aliCe p_61	alumiNio p_164	aRt p_141	bAr p_163	boNgo p_166	ciLo p_165	cráTer p_149	diAne p_61
									
hAlita p_141	haNs p_145	hoTel p_32	laMpetta p_65	laRa p_84	linDa p_49	liNk p_54	liSe p_67	lUce p_145	maGma p_146
									
maLi p_150	maRgot p_143	mArLin p_63	miA p_153	miTic p_81	miX p_45	mUrano p_144	nAn p_159	naNko p_149	nldo p_155
									
nitro p_167	nuDos p_103	óLEo p_167	oRa p_69	pAm p_161	paPillon p_137	pérgAmo p_155	plAtillo p_165	pLuma p_139	proSa p_153
									
quO p_94	retRo p_21	rlo p_89	sAba p_93	sAc p_100	sEven p_151	siRia p_167	siSmo p_147	sQuad p_159	swEet p_37
									
tavErn p_143	teMpo p_160	tHana p_77	tHym p_157	timbaL p_169	toRino p_109	tranSfer p_169	trEe p_42	vOlta p_29	wiNch p_96

































SPECIAL LUMINAIRES

LUMINARIAS ESPECIALES
AUTRES LUMINAIRES
LAMPADE SPECIALI

						
blisTer ledStrip p_376	caBi p_379	cLon p_378	flUo p_380	laMpi p_380	ledStrip p_376	uNit p_379

RECESSED

EMPOTRABLES
ENCASTRABLES
DA INCASSO

[new]									[new]
									
aRgón p_301	baTh p_339	carRé p_310	danA p_341	dOt p_289	eBba p_339	eMma p_310	eVa p_342	fiJo p_308	fLat p_283
[new]						[new]		[new]	[new]
									
foNt p_285	hElio p_307	kanT p_341	kiT p_309	kOi p_291	led miNi p_291	loKe p_223	lUx p_311	maLmo p_292	moNt p_287
		[new]			[new]				
									
móVil p_309	naRa p_339	nEón p_301	nEu p_297	neutrÓN p_305	nOrd p_297	nUsa p_289	ónice p_304	plAno p_302	pLas p_295
			[new]						
									
plaTón p_311	quArk p_310	quaSar p_341	rAdón p_299	tirSo p_296	veGa p_310	yEs p_293	zlrCón p_305		



































DESK LAMPS

FLEXOS
LAMPES DE BUREAU
LAMPADA DA LETTURA

	[new]								
									
aladiNo p_361	anoUk p_351	aRiel p_361	baObab p_359	bOb p_365	elBa p_363	gaLileo p_370	gRu p_359	lásEr p_371	lenA p_355
				[new]	[new]	[new]			
									
leNte p_371	lEO p_363	mulAn p_365	nioBe p_370	nuKa p_364	oNa p_351	oTto p_353	riMa p_353	Sam p_369	sElene p_366
									
sWan p_347	yeTi p_362								

TABLE LAMPS

SOBREMESAS
LAMPES DE TABLE
LAMPADE DA TAVOLO

									
akanE p_115	baBá p_357	baNker p_120	bLiss p_119	cHapí p_121	crEta p_75	dlx p_132	flExi p_53	hAlo p_349	hAt p_119
									
hoTel p_35	kAlen p_121	linDa p_47	liNk p_51	lUla p_113	miTic p_83	miX p_41	mOma p_73	náPoles p_105	niDia p_121
									
nOble p_133	quO p_95	retRo p_23	rlo p_87	sAba p_91	sAc p_99	sOul p_131	swEet p_39	tHana p_79	toRino p_107
					[new]				
trEe p_43	versUs p_117	veSper p_30	vOlta p_28	yAp p_357					

SPOTLIGHTS

FOCOS
SPOTS
FARETTI

									
áLamo p_189	blAt p_185	boReal p_179	eRis p_177	galAXia p_181	luNe p_200	miKa p_187	riNg p_172	sTar p_195	tubA p_182
									
tuRbo p_199	yUri p_175								

CLIPS

PINZAS
PINCES
PINZE



aladiNo
p_360



Lea
p_373

[new]



lenA
p_355



liLY
p_369



loKe
p_223



maGni
p_372



mAket
p_372



meRLín
p_369

[new]



nuKa
p_364



sElene
p_367



teR
p_368

FLOOR LAMPS

LÁMPARAS DE PIE
LAMPES DE PIED
PIANTANE



bLack
p_124



crEta
p_75



dlx
p_132



flExi
p_53

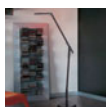

hAlo
p_348



hoTel
p_35



liLium
p_128



linDa
p_47



liNk
p_51



miTic
p_83



mOma
p_73



moNtana
p_126



nExo
p_123



nOble
p_133



papUa
p_127



quO
p_95

[new]



retRo
p_21



rlo
p_87



rOma
p_125



sAba
p_91



sAc
p_99



sOul
p_131



swEet
p_39



tHana
p_79

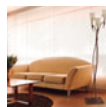

toRino
p_108



trEe
p_43

[new]



vOlta
p_29

TRACK PROJECTORS

APLIQUES
APPLIQUES
FARETTO PER BINARIO

[new]



nAn
p_205

[new]



pLot
p_206

[new]



rAm
p_207

[new]



riNg
p_205

WALL LAMP PICTURES

ILUMINA CUADROS
APPLIQUE TABLEAUS
ILLUMINA QUADRI

[new]



dEgas
p_249



heNlein
p_251



kLimt
p_249



luMiere
p_251



mOnet
p_251



aMi
p_265



aliCe
p_61



aRgón
p_301



anoUk
p_351



auRea
p_215



clOe
p_328



dAllas
p_231



diAne
p_61



foNt
p_285



giGi
p_61



hAlita
p_141



jaNet
p_262

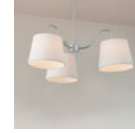

laRa
p_84



lenA
p_355



liSe
p_67



loKe
p_223



lUce
p_145



maLmo
p_292



kAo
p_329



maRgot
p_143



mArLin
p_63



mOnet
p_251



moNt
p_287



nAn
p_159, 205, 259



nEón
p_301



nOrd
p_297



nuKa
p_364



oNa
p_351



osLo
p_235



oTto
p_353



oVo
p_227



paPillon
p_137



pLot
p_206



rAdón
p_299



rAm
p_207



reL
p_260



rOom
p_211



ronDa
p_267



sAmi
p_221



sirEt
p_317

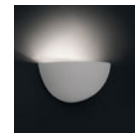

sNow
p_235



swiNg
p_214



teCto
p_254



tEd
p_337



tOd
p_337



uNit
p_379



vOlta
p_27



NEW



p_18

SERIES
SERIES
SÉRIES
SERIE



p_110

TABLE & FLOOR LAMPS
SOBREMESAS Y LÁMPARAS DE PIE
LAMPES DE TABLE ET DE PIED
LAMPADE DA TAVOLO E PIANTANE



p_134

SUSPENDED
COLGANTES
SUSPENSIONS
SOSPENSIONI



p_170

SPOTLIGHTS
FOCOS
SPOTS
FARETTI

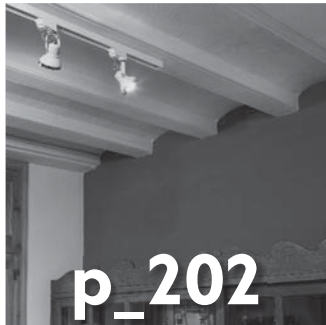

p_202

TRACK PROJECTORS
PROYECTORES DE CARRIL
PROJECTEURS SUR RAIL
FARETTO PER BINARIO

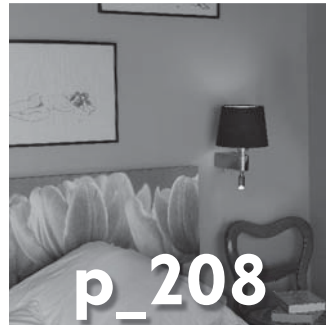

p_208

WALL FIXTURES
APLIQUES
APPLIQUES
LAMPADE DA PARETE



p_252

CEILING FIXTURES
PLAFONES
PLAFONNIER
PLAFONIERE



p_280

RECESSED
EMPOTRABLES
ENCASTRABLES
DA INCASSO



p_312

BATHROOM
BAÑO
SALLE DE BAIN
BAGNO



p_344

OFFICE
OFICINA Y ESTUDIO
BUREAU
UFFICIO



p_374

SPECIAL LUMINARIES
LUMINARIAS ESPECIALES
AUTRES LUMINAIRES
LAMPADE SPECIALI



Solutions that illuminate every room and every time, providing functionality, comfort and aesthetics.































Soluciones para iluminar cada estancia y cada momento, aportando funcionalidad, confort y estética.

Solutions qui éclairent toutes les pièces et tous les moments, en apportant de la fonctionnalité, du confort et de l'esthétique.

Soluzioni per illuminare ogni ambiente ed in ogni momento, apportando funzionalità, confort ed estetica.

series

series/séries/series

 aliCe [new] 60	 náPoles 104
 coCcote 56	 nuDos 102
 crEta 74	 oRa 68
 diAne [new] 60	 quO 94
 flExi 50	 retRo 20
 giGi [new] 60	 rlo 86
 hoTel 32	 sAba 90
 laMpetta 64	 sAc 98
 laRa [new] 84	 swEet 36
 linDa 46	 tHana 76
 liNk 52	 toRino 106
 liSe [new] 66	 trEe 40
 mArLin 62	 veSper 30
 miTic 80	 vOlta [new] 26
 miX 42	 wiNch 96
 mOma 70	

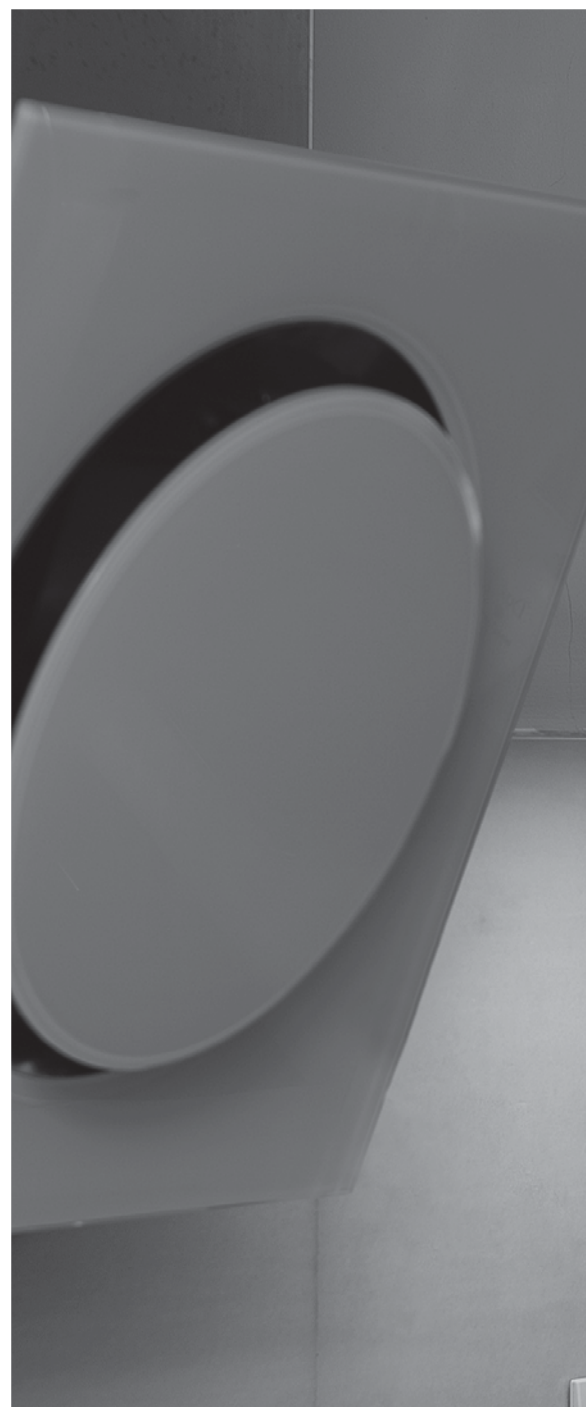



SERIES

series
series
séries
serie



retRo

by Manel Llusçà

With '60s nostalgia and looking into the decoration of the decade, we created this series of floodlights, harking back to shapes and colours of a retro style.

Con la nostalgia de los 60 e investigando en la decoración de la década, hemos creado esta línea de luminarias, recordando formas y colores de un estilo retro.

Avec la nostalgie des années 60 et les recherches faites sur la décoration de cette décennie, nous avons créé une ligne de luminaires qui rappellent les formes et les couleurs de ce style rétro.



[new] pendant lamp

- 20016 beige
beige
- 20017 olive green
verde oliva
- 20018 red
rojo

1 XE I4 MAX 20W NOT INCL. [I6239] [LED I7451]

METAL /
METAL

A++ to B / 100-240V ~ 50-60 Hz / 0.51 kg / 1.12 lb

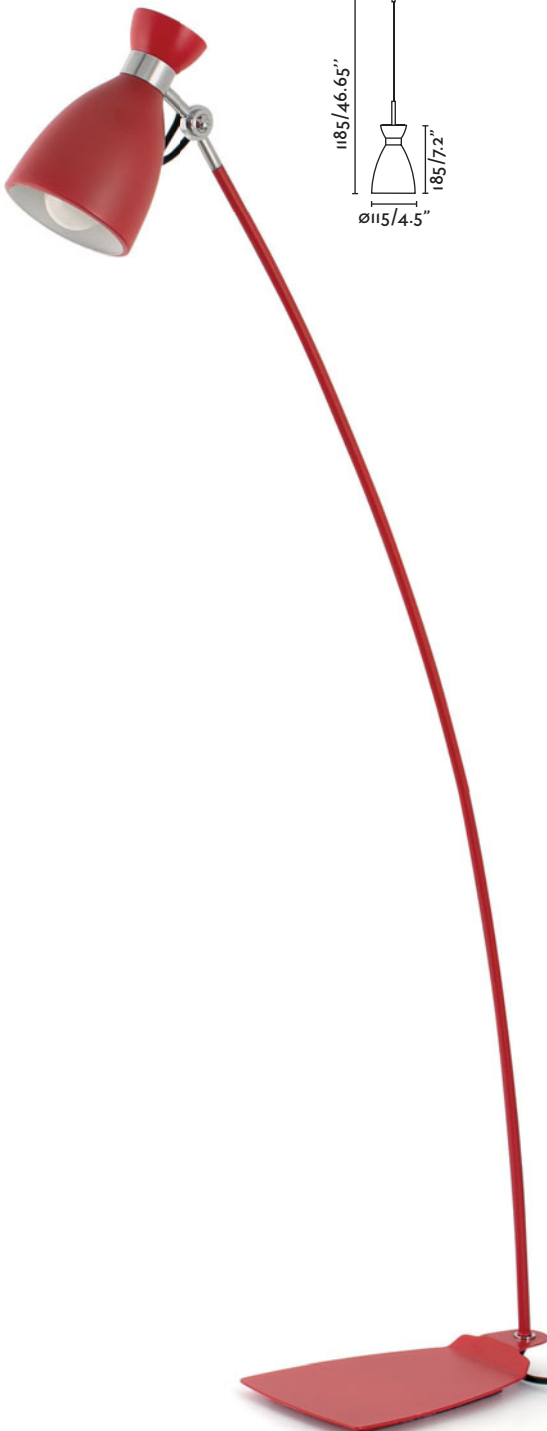
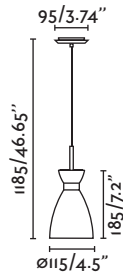

[new] floor lamp

- 20019 beige
beige
- 20020 olive green
verde oliva
- 20009 red
rojo

1 XE I4 MAX 20W NOT INCL. [I6239] [LED I7451]

METAL /
METAL

A++ to B / 100-240V ~ 50-60 Hz / 2.92 kg / 6.44 lb

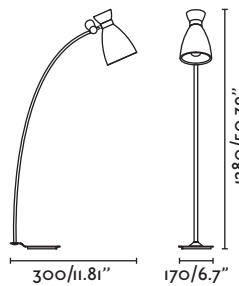

retRo

by Manel Llusçà





wall lamp

- 20000**  beige
- 20001**  olive green
verde oliva
- 20002**  red
rojo

I XE I4 MAX 20W NOT INCL. [16239] [LED 17451]

METAL /
METAL

A++ to B / 100-240V ~ 50-60 Hz / 0.65 kg / 1.43 lb

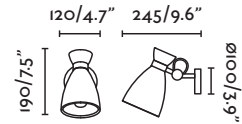



table lamp

- 20003**  beige
- 20004**  olive green
verde oliva
- 20005**  red
rojo

I XE I4 MAX 20W NOT INCL. [16239] [LED 17451]

METAL /
METAL

A++ to B / 100-240V ~ 50-60 Hz / 2 kg / 4.41 lb

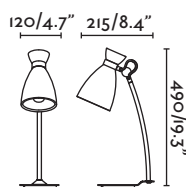

series
series
séries
serie

retRo

by Manel Llusçà





ceiling lamp

20006  beige
beige

20007  olive green
verde oliva

20008  red
rojo

3XE I4 MAX 20W NOT INCL. [16239] [LED 17451]

METAL /
METAL

A++ to B / 100-240V ~ 50-60 Hz / 1.9 kg / 4.19 lb

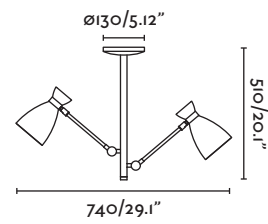

[new] ceiling lamp

20010  beige
beige

20011  olive green
verde oliva

20012  red
rojo

5XE I4 MAX 20W NOT INCL. [16239] [LED 17451]

METAL /
METAL

A++ to B / 100-240V ~ 50-60 Hz / 2.87 kg / 6.33 lb

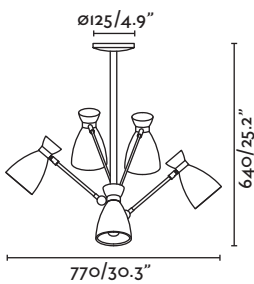

vOlta [new]

by Estudi Ribaudí

Volta is a timeless family with an elegant design. It proposes Nordic design spaces in perfect harmony.



Volta es una familia atemporal, con un diseño elegante. Nos propone espacios de diseño nórdico, en una perfecta armonía.

Volta est une famille intemporelle avec un design élégant. Nous proposons des espaces de design nordique en parfaite harmonie.





[new] wall lamp

- 20021  matt nickel+white
níquel mate+blanco
- 20022  matt nickel+black
níquel mate+negro



1 X E27 MAX 20W NOT INCL. [16292] [LED 17453]

METAL + TEXTILE /
METAL + TÉXIL

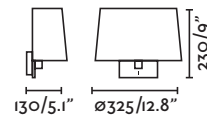
A++ to B / 100-240V ~ 50-60 Hz / 0.52 kg / 1.15 lb



[new] wall lamp+reader

- 20023  matt nickel+white
níquel mate+blanco
- 20024  matt nickel+black
níquel mate+negro

1 X E27 MAX 20W NOT INCL. [16292] [LED 17453]
HIGH POWER LED 3W 3000K 200LM INCL.
DRIVER INCL.

METAL + TEXTILE /
METAL + TÉXIL

A++ to B / 100-240V ~ 50-60 Hz / 0.72 kg / 1.59 lb

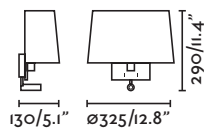





vOlta [new]

by Estudi Ribaudí



[new] table lamp

- 20025   matt nickel+white
níquel mate+blanco
- 20026   matt nickel+black
níquel mate+negro

1 X E27 MAX 20W NOT INCL. [16292] [LED 17453]



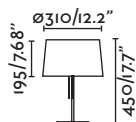

METAL + TEXTILE /
METAL + TÈXTIL

A++ to B / 100-240V ~ 50-60 Hz / 1.05 kg / 2.31 lb





[new] pendant lamp

- 20027   matt nickel+white
níquel mate+blanco
- 20028   matt nickel+black
níquel mate+negro



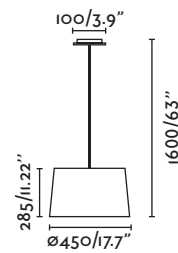

1 X E27 MAX 20W NOT INCL. [16219] [LED 17202]

METAL + TEXTILE /
METAL + TÉXIL

A++ to B / 100-240V ~ 50-60 Hz / 0.96 kg / 2.12 lb



[new] floor lamp

- 20029   matt nickel+white
níquel mate+blanco
- 20030   matt nickel+black
níquel mate+negro

1 X E27 MAX 20W NOT INCL. [16219] [LED 17202]

METAL + TEXTILE /
METAL + TÉXIL

A++ to B / 100-240V ~ 50-60 Hz / 2.85 kg / 6.28 lb

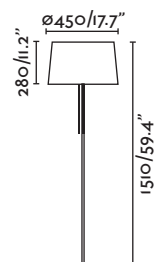

veSper

by Nahtrang

VESPER is a tribute to Remmi Mackintosh, one of the architects who broke the mould schemes looking for pure and rational forms.

VESPER es un homenaje a Remmi Mackintosh, uno de los arquitectos que rompió esquemas buscando formas puras y racionales.

VESPER c'est un hommage à Remmi Mackintosh, un des architectes qui a brisé les schémas pour rechercher des formes pures et rationnelles.

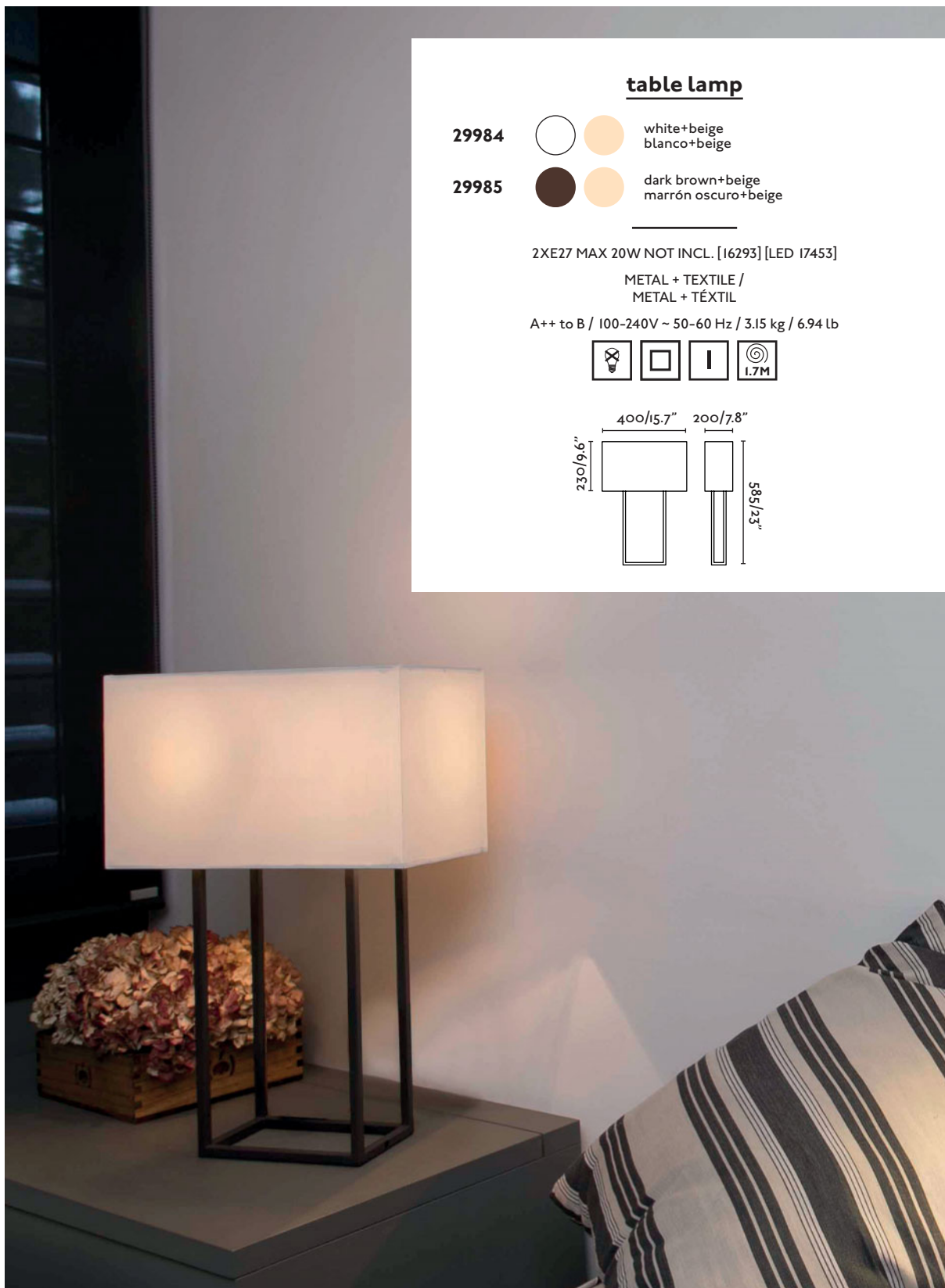

table lamp

29984



white+beige
blanco+beige

29985



dark brown+beige
marrón oscuro+beige

2XE27 MAX 20W NOT INCL. [16293] [LED 17453]

METAL + TEXTILE /
METAL + TÉXIL

A++ to B / 100-240V ~ 50-60 Hz / 3.15 kg / 6.94 lb

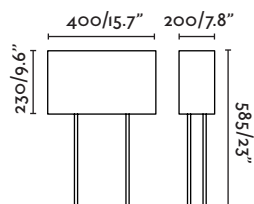





wall lamp

- 29980   white+beige
blanco+beige
- 29981   dark brown+beige
marrón oscuro+beige

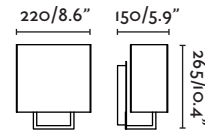
1 XE 14 MAX 20W NOT INCL. [16240] [LED
1745 I] METAL + TEXTILE /
METAL + TÉXIL
A++ to B / 100-240V ~ 50-60 Hz / 1.4 kg / 3.09 lb



wall lamp+reader

- 29982   white+beige
blanco+beige
- 29983   dark brown+beige
marrón oscuro+beige

1 XE 14 MAX 20W NOT INCL. [16240] [LED
1745 I] HIGH POWER LED 1W 3000K 120 LM
INCL. DRIVER INCL.
METAL + TEXTILE /
METAL + TÉXIL
A++ to C / 100-240V ~ 50-60 Hz / 1.55 kg / 3.42 lb

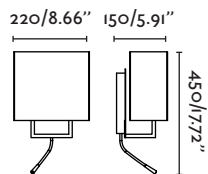

hoTel

by Manel Lluscà

The HOTEL serie aims to achieve a simple and somewhat neutral line, giving prominence to the warmth and comfort it offers. For a relaxing and pleasant environment.

La serie HOTEL pretende seguir una línea sobria y un tanto neutra dando protagonismo a la calidez y practicidad que aporta. Para conseguir un ambiente sosegado, nítido y agradable.

Le design de la série HOTEL tend vers la sobriété et la neutralité afin de mettre en valeur la chaleur et le confort qu'elle apporte. Pour une ambiance détendue, claire et agréable.



pendant lamp

29944



chrome+white
cromo+blanco

29949



chrome+black
cromo+negro

3XE27 MAX 20W NOT INCL. [I6177]

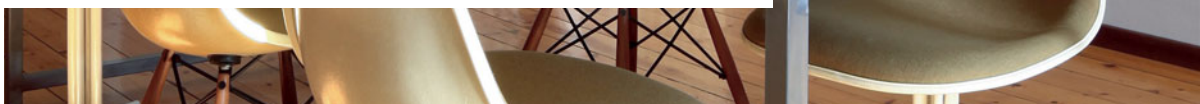
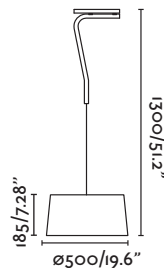

METAL + TEXTILE /
METAL + TÉXIL

A++ to B / 100-240V ~ 50-60 Hz / 5 kg / 11.02 lb





wall lamp

- 29940  chrome+white
cromo+blanco
- 29945  chrome +black
cromo +negro



I XE27 MAX 15W NOT INCL. [16292] [LED 17453]

METAL + TEXTILE /
METAL + T XNIL

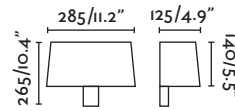
A++ to B / 100-240V ~ 50-60 Hz / 1.1 kg / 2.43 lb



wall lamp+reader

- 29941  chrome+white
cromo+blanco
- 29946  chrome+black
cromo+negro

I XE27 MAX 15W NOT INCL. [16292] [LED 17453]
HIGH POWER LED 1W 3500K INCL.
DRIVER INCL.

METAL + TEXTILE /
METAL + T XNIL

A++ to B / 100-240V ~ 50-60 Hz / 1.5 kg / 3.31 lb

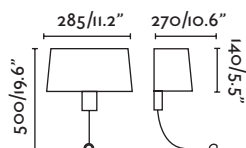





hoTel

by Manel Lluscà





floor lamp

- 29943   chrome+white
cromo+blanco
- 29948   chrome+black
cromo+negro





I XE27 MAX 20W NOT INCL. [16177] [LED 17202]

METAL + TEXTILE /
METAL + TÉXIL

A++ to B / 100-240V ~ 50-60 Hz / 7.1 kg / 15.65 lb



table lamp

- 29942   chrome+white
cromo+blanco
- 29947   chrome+black
cromo+negro

I XE27 MAX 20W NOT INCL. [16293] [LED 17453]

METAL + TEXTILE /
METAL + TÉXIL

A++ to B / 100-240V ~ 50-60 Hz / 2.8 kg / 6.17 lb



swEet

by Estudi Ribaudí

SWEET is characterised by its rounded shapes and the harmony of its changes in texture that interact with us in a perfect balance.

SWEET se caracteriza por sus formas redondeadas y la armonía de sus cambios de textura que interactúan con nosotros en perfecto equilibrio.

SWEET est caractérisée par ses formes arrondies et par l'harmonie de ses changements de matière qui interagissent avec nous dans un équilibre parfait.

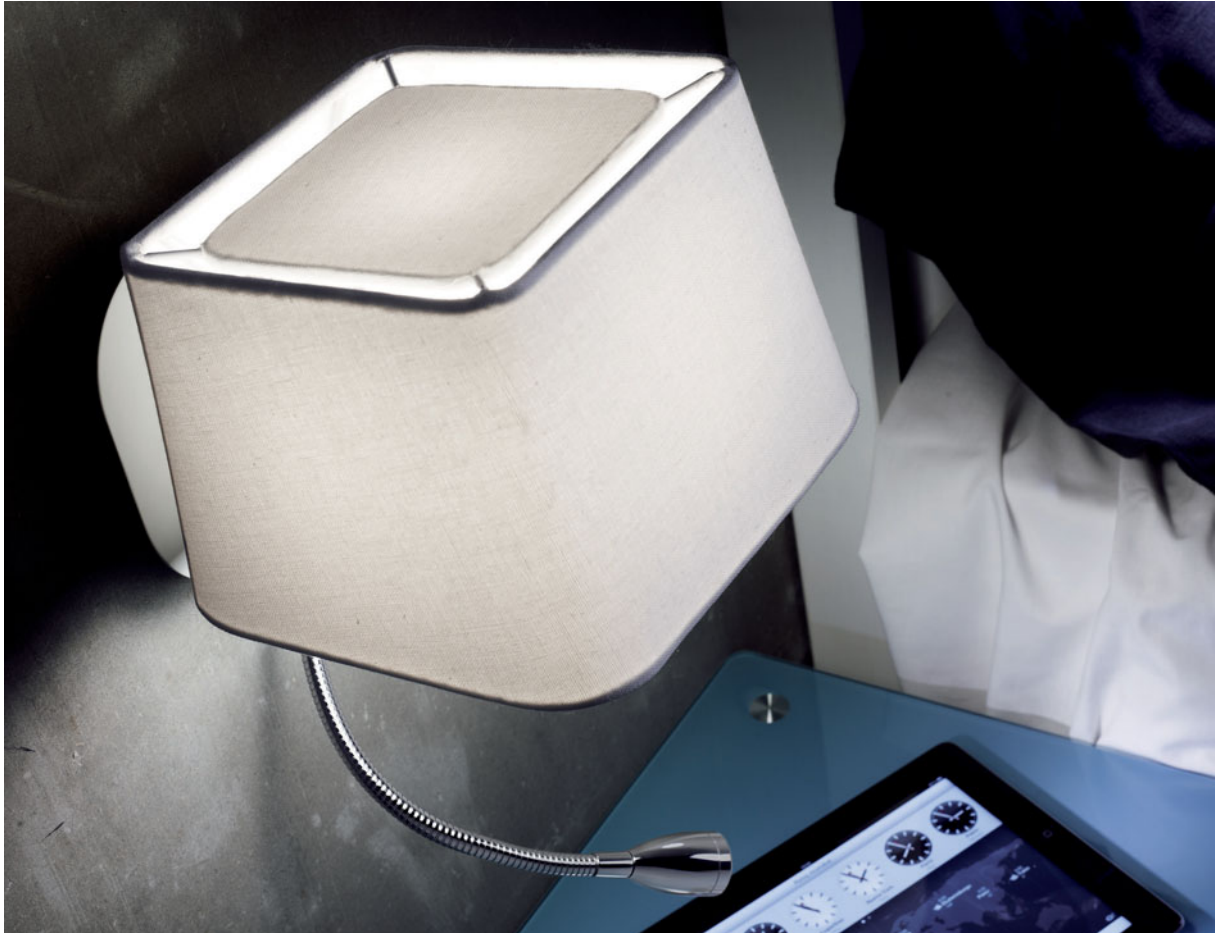

wall lamp+reader

[new] 29935



matt nickel+white
níquel mate+blanco

29950



white
blanco

29951



black
negro

1 X E27 MAX 15W NOT INCL. [I6292] [LED 17453]
HIGH POWER LED 1W INCL.
DRIVER INCL.



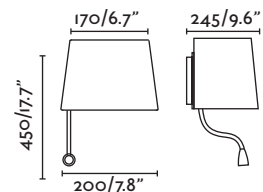

METAL + TEXTILE /
METAL + TÉXTIL

A++ to B / 100-240V ~ 50-60 Hz / 1.7 kg / 3.75 lb





wall lamp

- [new] 29936**   matt nickel+white
níquel mate+blanco
- 29952**  white
blanco
- 29953**  black
negro



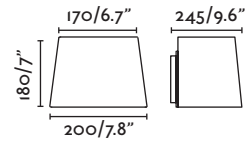

1 XE27 MAX 15W NOT INCL. [16292] [LED 17453]

METAL + TEXTILE /
METAL + TÉXTIL

A++ to B / 100-240V ~ 50-60 Hz / 1.2 kg / 2.65 lb



pendant lamp

- [new] 29939**   matt nickel+white
níquel mate+blanco
- 29956**  white
blanco
- 29957**  black
negro

1 XE27 MAX 20W NOT INCL. [16293] [LED 17202]

METAL + TEXTILE /
METAL + TÉXTIL

A++ to B / 100-240V ~ 50-60 Hz / 2.9 kg / 6.39 lb

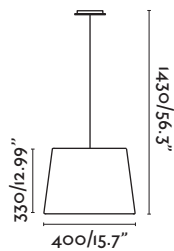





swEet

by Estudi Ribaudí





floor lamp

- [new] 29938**   matt nickel+white
níquel mate+blanco
- 29958**  white
blanco
- 29959**  black
negro





1 XE27 MAX 20W NOT INCL. [16177] [LED 17202]

METAL + TEXTILE /
METAL + TÉXTIL

A++ to B / 100-240V ~ 50-60 Hz / 5.8 kg / 12.79 lb



table lamp

- [new] 29937**   matt nickel+white
níquel mate+blanco
- 29954**  white
blanco
- 29955**  black
negro

1 XE27 MAX 20W NOT INCL. [16293] [LED 17453]

METAL + TEXTILE /
METAL + TÉXTIL

A++ to B / 100-240V ~ 50-60 Hz / 3.6 kg / 7.94 lb



trEe

by Estudi Ribaudí

TREE stems from the interaction of human beings with their environment. Its branches grow towards the top, which is where the light emerges from.

TREE nace de la interacción del ser humano con su entorno. Sus ramas crecen hacia el interior de la copa, y es allí donde surge la luz.

TREE est le fruit de l'interaction de l'homme avec son environnement. Ses branches poussent vers la cime, d'où jaillit la lumière.



pendant lamp

29864



black
negro

29865



white
blanco

1 X E27 MAX 100W NOT INCL. [16212] [LED 17202]

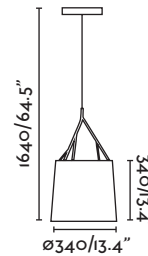

METAL + TEXTILE /
METAL + TÉXIL

A++ to E / 100-240V ~ 50-60 Hz / 3 kg / 6.61 lb







floor lamp

- 29868  black negro
- 29869  white blanco

1 XE27 MAX 60W NOT INCL. [16212] [LED 17202]
 METAL + TEXTILE /
 METAL + T XNIL
 A++ to E / 100-240V ~ 50-60 Hz / 8.2 kg / 18.08 lb



table lamp

- 29866  black negro
- 29867  white blanco

1 XE27 MAX 60W NOT INCL. [16212] [LED 17453]
 METAL + TEXTILE /
 METAL + T XNIL
 A++ to E / 100-240V ~ 50-60 Hz / 3.9 kg / 8.60 lb



miX

by Manel Lluscà

A mixture of materials for a series that provides the warmth of light by creating a comfortable environment. Discrete slits allow light to shine out, generating a chiaro-scuro effect.

Mixtura de materiales para una serie que consigue ofrecer la calidez de la luz generando un ambiente confortable. Discretas rendijas dejan escapar la luz generando un juego de claroscuros.

Un mélange de matériaux pour une série qui parvient à transmettre la chaleur de la lumière et à créer un environnement confortable. Des fentes discrètes laissent passer la lumière et créent un jeu de clair-obscur.



shelf wall lamp

29960

white
blanco

29961

black
negro

I XE I4 MAX 14W NOT INCL. [16269] [LED 17451]

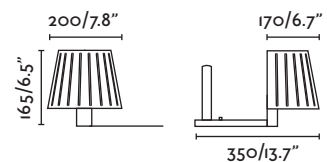

METAL /
METAL

A++ to E / 100-240V ~ 50-60 Hz / 1.4 kg / 3.09 lb







wall lamp

- 29964  white
blanco
- 29965  black
negro

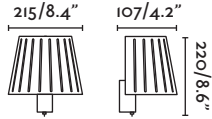
1 X E27 MAX 60W NOT INCL. [16219] [LED 17453]
METAL /
METAL
A++ to E / 100-240V ~ 50-60 Hz / 0.8 kg / 1.76 lb



wall lamp+reader

- 29962  white
blanco
- 29963  black
negro

1 X E27 MAX 60W NOT INCL. [16219] [LED 17453]
HIGH POWER LED 3W INCL.
DRIVER INCL.
METAL /
METAL
A++ to D / 100-240V ~ 50-60 Hz / 1.2 kg / 2.65 lb

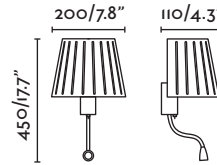

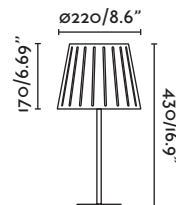

table lamp

- 29970  white
blanco
- 29971  black
negro

1 X E14 MAX 60W NOT INCL. [16269] [LED 17451]
METAL + WOOD /
METAL + MADERA
A++ to E / 100-240V ~ 50-60 Hz / 2.3 kg / 5.07 lb





miX
by Manel Llusçà





pendant lamp

- 29968  white
blanco
- 29969  black
negro



2XE27 MAX 60W NOT INCL. [I6212] [LED I7202]

METAL + WOOD /
METAL + MADERA

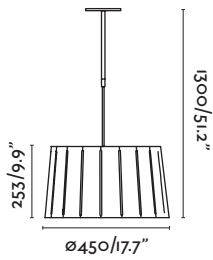
A++ to E / 100-240V ~ 50-60 Hz / 4.9 kg / 10.80 lb



pendant lamp

- 29966  white
blanco
- 29967  black
negro

1XE14 MAX 60W NOT INCL. [I6269] [LED I7451]

METAL /
METAL

A++ to E / 100-240V ~ 50-60 Hz / 1.2 kg / 2.65 lb

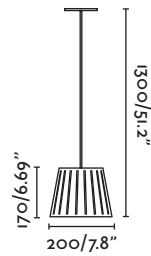

linDa

by Estudi Ribaudí

LINDA projects light through its structure, creating a pattern of light and shadow that confers movement and energy to our spaces.

LINDA proyecta la luz a través de su estructura, generando una trama de luces y sombras que ofrecen movimiento y dinamismo a nuestros espacios.

LINDA projette la lumière à travers sa structure, créant ainsi toute une trame d'ombres et de lumières qui apportent mouvement et dynamisme à nos espaces.





table lamp

29307



white
blanco

29311



black
negro

1 X E27 MAX 100W NOT INCL. [16212] [LED 17202]

STEEL + TEXTILE /
ACERO + TÉXIL

A++ to E / 100-240V ~ 50-60 Hz / 3.5 kg / 7.72 lb

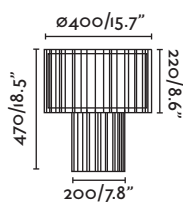

floor lamp

29308



white
blanco

29312



black
negro

1 X E27 MAX 100W NOT INCL. [16212] [LED 17202]

STEEL + TEXTILE /
ACERO + TÉXIL

A++ to E / 100-240V ~ 50-60 Hz / 6.5 kg / 14.33 lb

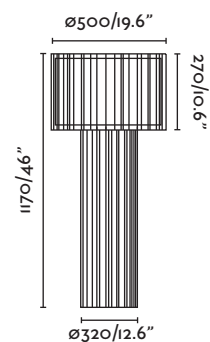

linDa

by Estudi Ribaudí



wall lamp

29306  white
blanco

29310  black
negro

2XE27 MAX 15W NOT INCL. [16166] [LED 17453]

STEEL + TEXTILE /
ACERO + TÉXTIL

A++ to E / 100-240V ~ 50-60 Hz / 1.4 kg / 3.09 lb



pendant lamp

29309  white
blanco

29313  black
negro

1XE27 MAX 100W NOT INCL. [16212] [LED 17453]

STEEL + TEXTILE /
ACERO + TÉXTIL

A++ to E / 100-240V ~ 50-60 Hz / 4.8 kg / 10.58 lb

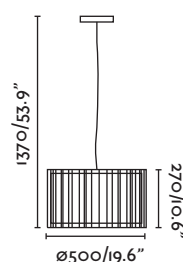

fLExi

by Manel Lluscà

A casual, very versatile luminaire line with infinite positions and great practical applications. It can be used constantly to create new shapes.

Una línea de luminaria desenfadada, muy versátil, de infinitas posiciones y de gran practicidad. Con la que constantemente podemos crear nuevas formas.

Une ligne de luminaires apaisants, polyvalents, orientables à l'infini et extrêmement pratiques qui nous permettent de créer de nouvelles formes.



wall lamp

- 29928  white
blanco
- 29929  black
negro
- 29930  magenta
magenta
- 29931  lime green
verde lima

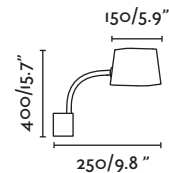

1 X E27 MAX 15W NOT INCL. [I6322] [LED 17452]

ACRYLIC + POLYCARBONATE + STEEL /
ACRÍLICO + POLICARBONATO + ACERO

A++ to B / 100-240V ~ 50-60 Hz / 1.48 kg / 3.26 lb



table lamp

- 29920  white
blanco
- 29921  black
negro
- 29922  magenta
magenta
- 29923  lime green
verde lima

1 XE27 MAX 15W NOT INCL. [16322] [LED 17452]

ACRYLIC + POLYCARBONATE + STEEL /
ACRÍLICO + POLICARBONATO + ACERO

A++ to B / 100-240V ~ 50-60 Hz / 2.39 kg / 5.27 lb

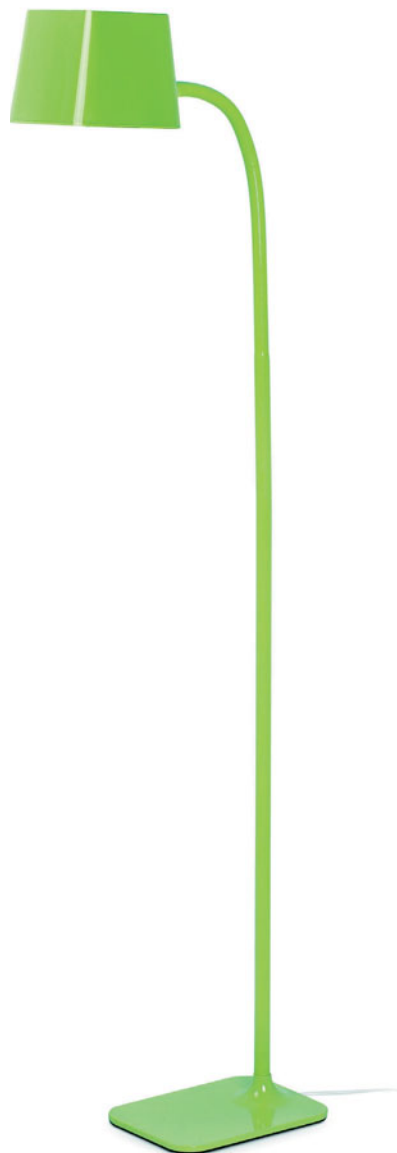

floor lamp

- 29924  white
blanco
- 29925  black
negro
- 29926  magenta
magenta
- 29927  lime green
verde lima

1 XE27 MAX 15W NOT INCL. [16322] [LED 17452]

ACRYLIC + POLYCARBONATE + STEEL /
ACRÍLICO + POLICARBONATO + ACERO

A++ to B / 100-240V ~ 50-60 Hz / 4.3 kg / 9.48 lb

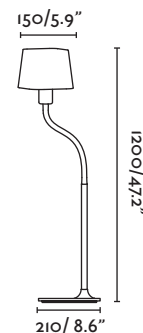

LiNk

by Estudi Ribaudí

LINK is the synthesis of a spot as an object. It is a search for the absence of shape, a simple gesture to give sense to its aesthetic.

LINK es la síntesis del foco como objeto; es la búsqueda de la ausencia de la forma, un simple gesto para encontrar una estética que le da sentido.

LINK est la synthèse du spot en tant qu'objet ; c'est la recherche de l'absence de forme, une esthétique simple qui lui donne tout son sens.



wall lamp

29875  white
blanco

29876  black
negro

2XGU10 MAX II W NOT INCL. [LED 14140]

STEEL /
ACERO

A++ to B / 100-240V ~ 50-60 Hz / 1.2 kg / 2.65 lb

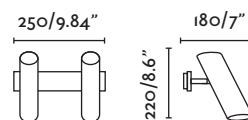

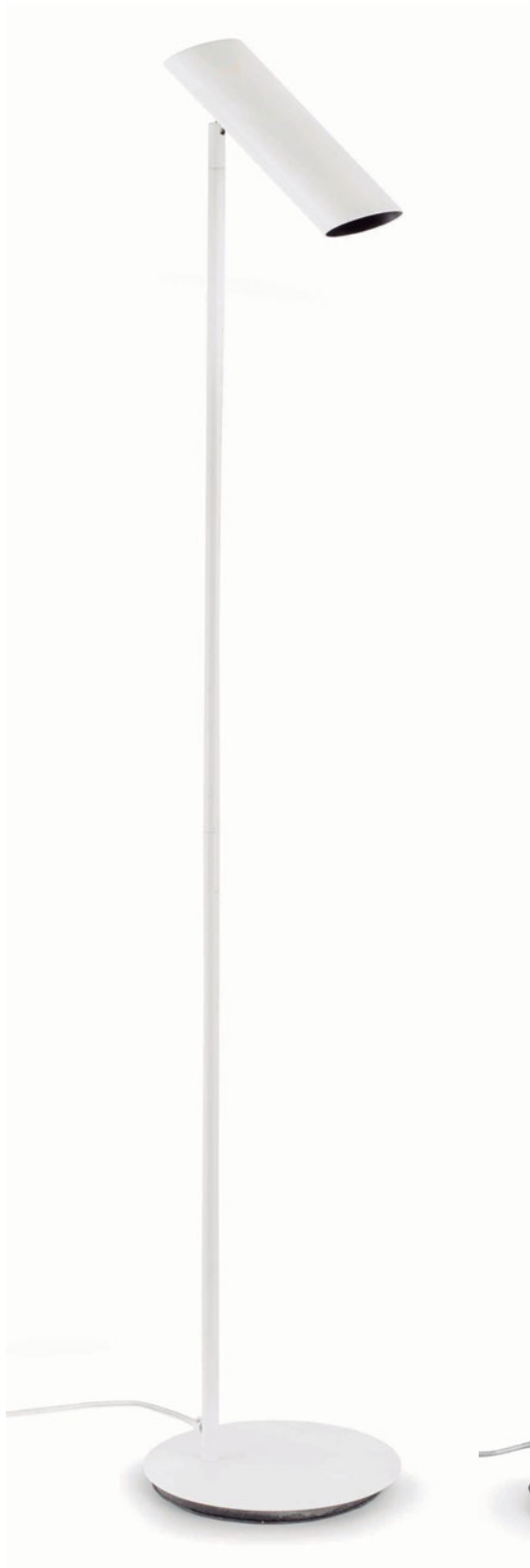

floor lamp

29883  white
blanco

29884  black
negro

1 XGU10 MAX II W NOT INCL. [LED I4140]

STEEL /
ACERO

A++ to B / 100-240V ~ 50-60 Hz / 3.1 kg / 6.83 lb

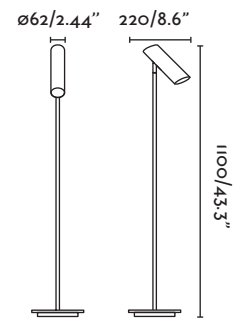

table lamp

29881  white
blanco

29882  black
negro

1 XGU10 MAX II W NOT INCL. [LED I4140]

STEEL /
ACERO

A++ to B / 100-240V ~ 50-60 Hz / 1.77 kg / 3.90 lb

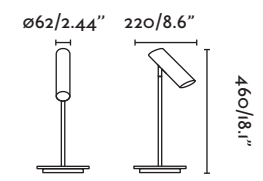

LiNk

by Estudi Ribaudí



pendant lamp

29879

white
blanco

29880

black
negro

4XGU10 MAX II W NOT INCL. [LED I4140]

STEEL /
ACERO

A++ to B / 100-240V ~ 50-60 Hz / 3.3 kg / 7.28 lb

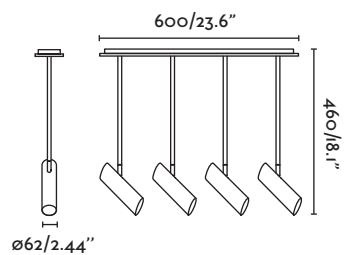



pendant lamp

29877  white
blanco

29878  black
negro

1 XGU10 MAX II W NOT INCL. [LED I4I40]

STEEL /
ACERO

A++ to B / 100-240V ~ 50-60 Hz / 0.8 kg / 1.76 lb

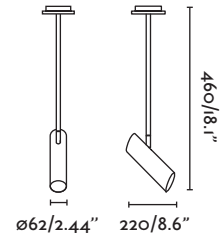

wall lamp

29873  white
blanco

29874  black
negro

1 XGU10 MAX II W NOT INCL. [LED I4I40]

STEEL /
ACERO

A++ to B / 100-240V ~ 50-60 Hz / 0.6 kg / 1.32 lb

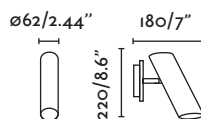

coCote

by Jordi Llopis

An elegant piece with character, while sober and timeless. Cocotte is characterized by giving the same importance to the diffuser that projects light as to the metal mounting base.

Una pieza elegante, con carácter, a la vez que sobria y atemporal. Cocotte se caracteriza por dar el mismo protagonismo al difusor que proyecta la luz que a la base metálica de fijación.

Une pièce élégante au caractère à la fois sobre et atemporel. Cocotte se caractérise pour donner la même importance au diffuseur qui projette la lumière qu'à la base métallique de fixation.



ceiling lamp-p

64180  matt white
blanco mate

64181  shiny black
negro brillante

1 XT5 MAX 40W NOT INCL. [9724040]
GEAR INCL.

METAL + OPAL ACRYLIC /
METAL + ACRÍLICO OPAL

A to B / 220-240V ~ 50-60 Hz / 1.97 kg / 4.34 lb



BALLAST 

Ø430/16.92"



80/3.14"



LED

[new] ceiling lamp-g

64182  matt white
blanco mate

64183  shiny black
negro brillante

SMD LED 42W 2700K 1700LM INCL.
DRIVER INCL.

METAL + OPAL ACRYLIC /
METAL + ACRÍLICO OPAL

A / 100-240V ~ 50-60 Hz / 2.81 kg / 6.19 lb



DRIVER 



Ø550/21.6"

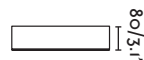

80/3.1"



coCcote

by Jordi Llopis







[new] SUSPENSION KIT ACCESSORY /
KIT SUSPENSIÓN ACCESORIO -P

- 64184**  white
blanco
- 64185**  black
negro

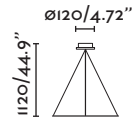
FOR 64180 AND 64181 / PARA REFS. 64180 Y 64181
METAL /
METAL



[new] SUSPENSION KIT ACCESSORY /
KIT SUSPENSIÓN ACCESORIO -G

- 64186**  white
blanco
- 64187**  black
negro

FOR 64182 AND 64183 / PARA REFS. 64182 Y 64183
METAL /
METAL

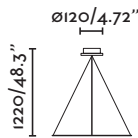

giGi, diAne & aliCe [new]

Modern fixtures made from enamel. Highly decorative solutions. Ideal for both home and for retail.

Luminarias modernas fabricadas en esmalte. Soluciones altamente decorativas. Ideales tanto para estancias del hogar como para comercios.

Lampes modernes et fabriquée en émail. Des solutions très décoratifs. Idéal pour la maison et pour le détail.



[new] **diAne**
pendant lamp

OUT OF CATALOGUE
DESCATALOGADO

68570



dark green
verde oscuro

OUT OF CATALOGUE
DESCATALOGADO

68571



black
negro

1 XE27 40W NOT INCL. [LED 17200]

ENAMEL METAL /
METAL ESMALTADO

A++ to E / 100-240V ~ 50-60 Hz / 1.3 kg / 2.87 lb

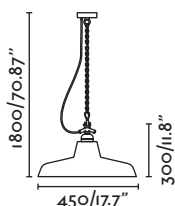

[new] **giGi**
wall lamp

OUT OF CATALOGUE
DESCATALOGADO

68576



black
negro

68577



dark green
verde oscuro

1 XE27 40W NOT INCL. [LED 17453]

ENAMEL METAL /
METAL ESMALTADO

A++ to E / 100-240V ~ 50-60 Hz / 1.12 kg / 2.47 lb

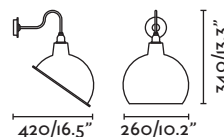

[new] **aliCe**
pendant lamp

OUT OF CATALOGUE
DESCATALOGADO

68573



red
rojo

OUT OF CATALOGUE
DESCATALOGADO

68574



black
negro

1 XE27 40W NOT INCL. [LED 17452]

ENAMEL METAL /
METAL ESMALTADO

A++ to E / 100-240V ~ 50-60 Hz / 1.12 kg / 2.47 lb

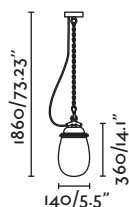

mArlin

Modern indoor lighting collection. Made from metal and transparent glass diffuser. Finished in old gold with white or black.

Familia de estilo moderno fabricada en metal y difusor de cristal transparente. En oro envejecido con negro o blanco.

Collection moderne pour l'éclairage intérieur. Fabriquée en métal et diffuseur en verre transparent. En or antique avec noir o blanc.





[new] wall lamp

65133



old gold+black
oro envejecido+negro

I XE27 MAX 40W NOT INCL. [10310]

METAL + GLASS /
METAL + CRISTAL

A++ to E / 100-240V ~ 50-60 Hz / 0.9 kg / 1.98 lb

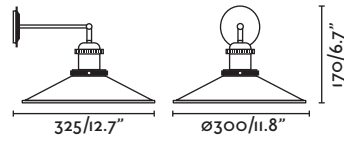

pendant lamp

64133



old gold+black
oro envejecido+negro

64134



old gold+white
oro envejecido+blanco

I XE27 MAX 60W NOT INCL. [16219] [10310]

METAL + GLASS /
METAL + CRISTAL

A++ to E / 100-240V ~ 50-60 Hz / 1.3 kg / 2.87 lb

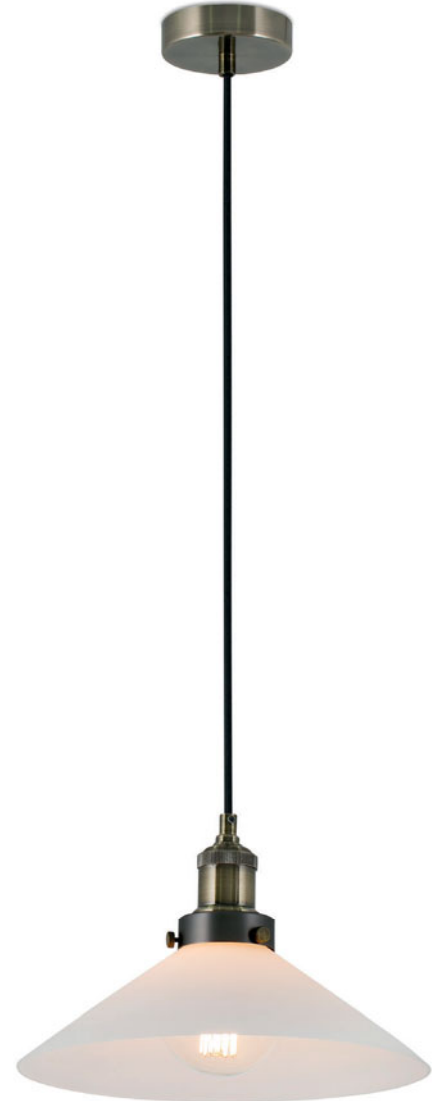
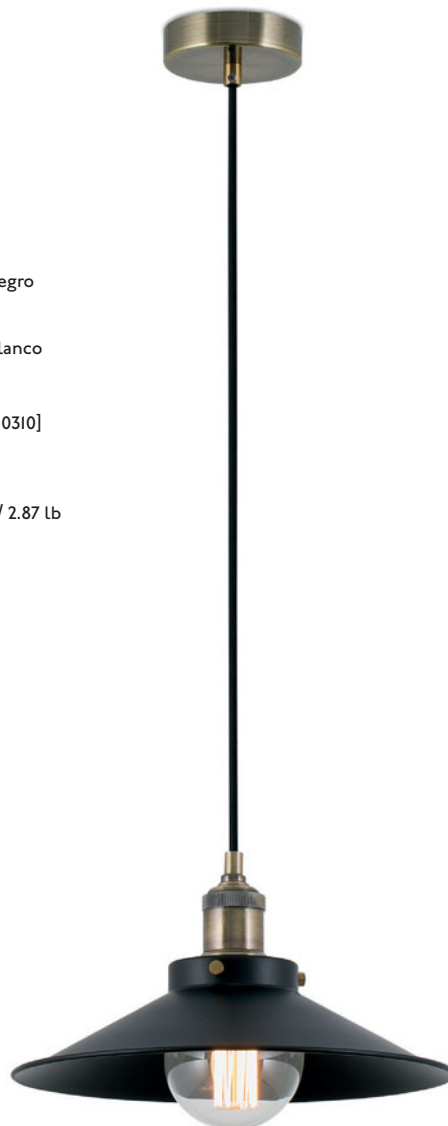
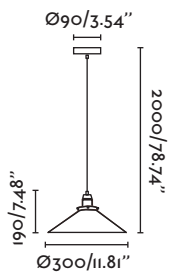

laMpetta

by Jesper K. Thomsen

The historical italian motor-bike is the object that stimulates Jesper to create his last model.

La histórica motocicleta italiana es el objeto que estimuló a Jesper en la realización de su último modelo.

L'historique motocyclette italienne est l'objet qui a stimulé Jesper dans la réalisation de son dernier modèle.





OUT OF CATALOGUE
DESCATALOGADO

pendant lamp-g

29853

● black
negro

1 X E27 MAX 100W NOT INCL. [16293] [LED 17453]

STEEL + GLASS /
ACERO + CRISTAL

A++ to E / 100-240V ~ 50-60 Hz / 5.1 kg / 11.24 lb

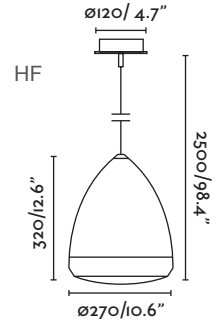

OUT OF CATALOGUE
DESCATALOGADO

29850

● off white
blanco roto

OUT OF CATALOGUE
DESCATALOGADO

29851

● black
negro

1 X E14 MAX 40W NOT INCL. [16321] [LED 17451]

STEEL + GLASS /
ACERO + CRISTAL

A++ to E / 100-240V ~ 50-60 Hz / 2.3 kg / 5.07 lb

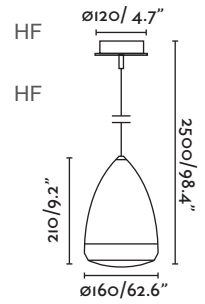

HF Until stock exhaustion
Hasta final de stock
Jusqu'à la fin de stock

DIMMABLE
DIMABLE

wall lamp

29854

● off white
blanco roto

29855

● black
negro

1 X GY 6,35 MAX 50W NOT INCL. [13003]

STEEL + GLASS /
ACERO + CRISTAL

A++ to E / 100-240V ~ 50-60 Hz / 1.4 kg / 3.09 lb

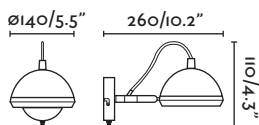

series
series
séries
serie

LiSe [new]

LISE is an indoor lighting set comprising one spotlight, one wall lamp and one pendant lamp, with black or white finish.

LISE es una serie de iluminación interior compuesta por un foco y un colgante con acabados en blanco y negro.

LISE est une série pour éclairage intérieur composée d'un spot et une lampe suspendue avec finitions en noir et blanc.



[new] **liSe**
pendant lamp

29886  white
blanco

29887  black
negro

COB LED 6W 2700K 370LM CRI>80 INCL.
DRIVER INCL.

ALUMINIUM /
ALUMINIO

A+ / 100-240V ~ 50-60 Hz / 0.75 kg / 1.65 lb



[new] **liSe**
wall lamp

29888  white
blanco

29889  black
negro

COB LED 12W 2700K 740LM CRI>80 INCL.
DRIVER INCL.

ALUMINIUM /
ALUMINIO

A+ / 100-240V ~ 50-60 Hz / 0.51 kg / 1.12 lb

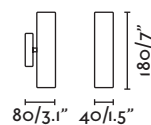

oRa

ORA is an indoor lighting set comprising one spotlight, one wall lamp and one pendant lamp, with black or white finish.

ORA es una serie de iluminación interior compuesta por un foco y un colgante con acabados en blanco y negro.

ORA est une série pour éclairage intérieur composée d'un spot et une lampe suspendue avec finitions en noir et blanc.





pendant lamp

29894  white
blanco

29895  black
negro

SMD LED 4W 3000K 350LM CRI>80 INCL.
DRIVER INCL.

ALUMINIUM + METAL + PMMA /
ALUMINIO + METAL + PMMA

A++ / 220-240V ~ 50-60 Hz / 0.38 kg / 0.84 lb

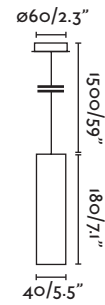

wall lamp

29890  white
blanco

29891  black
negro

SMD LED 4W 3000K 350LM CRI>80 INCL.
DRIVER INCL.

ALUMINIUM + METAL + PMMA /
ALUMINIO + METAL + PMMA

A++ / 220-240V ~ 50-60 Hz / 0.25 kg / 0.55 lb

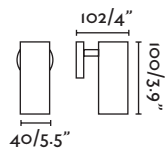

mOma

Collection for indoor lighting
made from steel and a textile
shade.





Familia de estilo moderno para
iluminación interior fabricada en
acero, pantalla textil y difusor
de PVC.

Collection de style moderne
fabriquée en acier, abat-jour en
textile.





wall lamp

- 68504**   chrome+white
cromo+blanco
- 68505**   chrome+black
cromo+negro



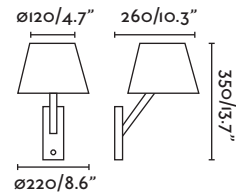

1 XE27 MAX 60W NOT INCL. [16166] [LED 17453]

METAL + TEXTILE /
METAL + TÉXTIL

A++ to E / 100-240V ~ 50-60 Hz / 1.4 kg / 3.09 lb



wall lamp+reader

- 68506**   chrome+white
cromo+blanco
- 68507**   chrome+black
cromo+negro

1 XE27 MAX 60W NOT INCL. [16166] [LED 17453]
HIGH POWER LED 1 W 6000K 80LM INCL.
DRIVER INCL.

METAL + TEXTILE /
METAL + TÉXTIL

A++ to E / 100-240V ~ 50-60 Hz / 1.6 kg / 3.53 lb

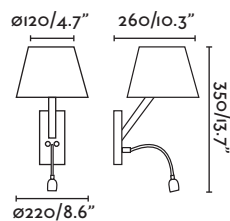

mOma



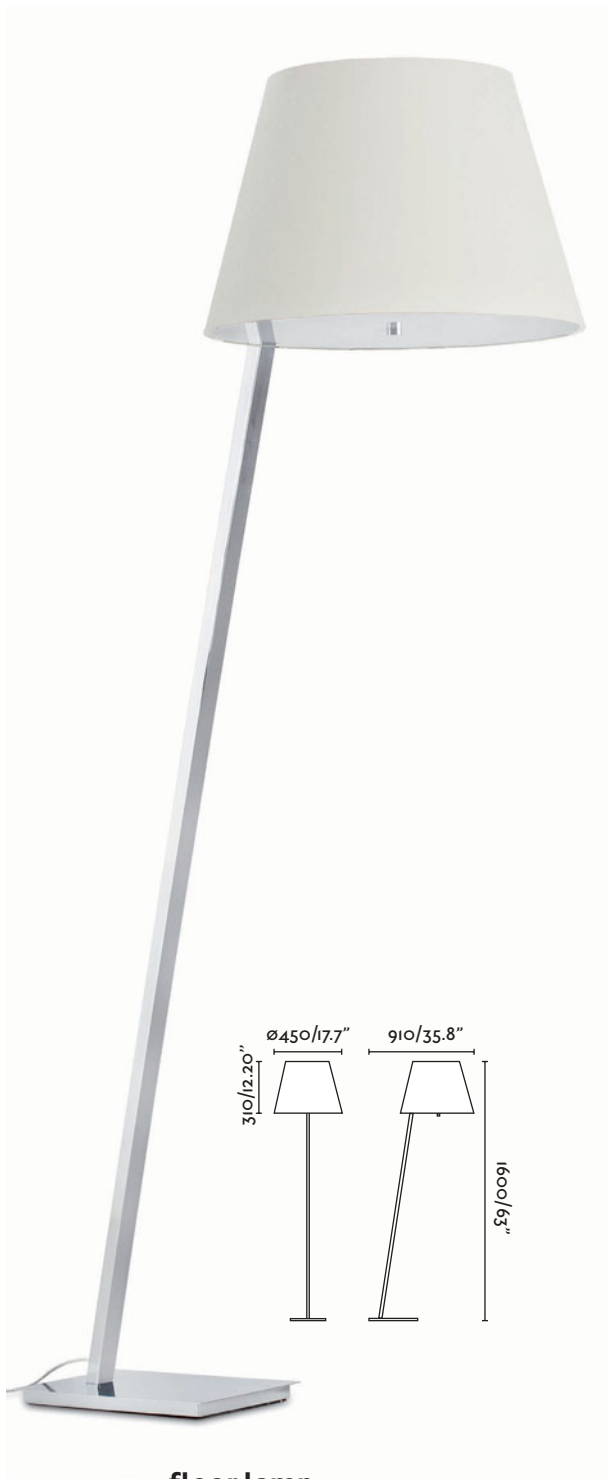

floor lamp

68502   chrome+white
cromo+blanco

68503   chrome+black
cromo+negro

I XE27 MAX 60W NOT INCL. [16167] [LED 17202]

METAL + TEXTILE /
METAL + TÉXIL

A++ to E / 100-240V ~ 50-60 Hz / 9.8 kg / 21.61 lb



table lamp

68500   chrome+white
cromo+blanco

68501   chrome+black
cromo+negro

I XE27 MAX 60W NOT INCL. [16166]

METAL + TEXTILE /
METAL + TÉXIL

A++ to E / 100-240V ~ 50-60 Hz / 2.8 kg / 6.17 lb



crEta

Collection for indoor lighting made from metal with a textile shade.

Familia de aplique, sobremesa y lámpara de pie. Fabricada en metal y pantalla textil

Collection moderne pour éclairage en intérieur fabriqué en métal et en textile.



wall lamp

68515



matt nickel+white
níquel mate+blanco

1 X E27 MAX 60W NOT INCL. [16177] [LED 17453]

METAL + TEXTILE /
METAL + TÉXTIL

A++ to E / 100-240V ~ 50-60 Hz / 1.08 kg / 2.38 lb

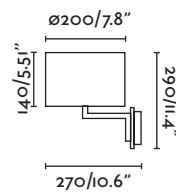



floor lamp

68514



matt nickel+white
níquel mate+blanco

1 XE27 MAX 60W NOT INCL. [16177] [LED 17202]

METAL + TEXTILE /
METAL + TÉXIL

A++ to E / 100-240V ~ 50-60 Hz / 7.46 kg / 16.45 lb

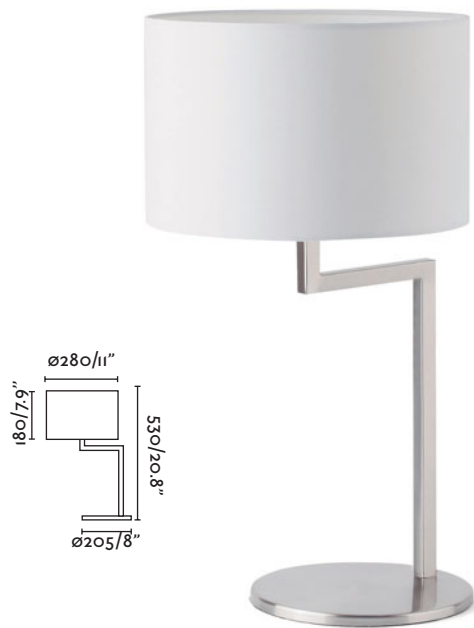

table lamp

68513



matt nickel+white
níquel mate+blanco

1 XE27 MAX 60W NOT INCL. [16177] [LED 17453]

METAL + TEXTILE /
METAL + TÉXIL

A++ to E / 100-240V ~ 50-60 Hz / 4.11 kg / 9.06 lb



tHana

Collection for indoor lighting:
Wall lamp, table lamp, pen-
dant and floor lamp. In matt
nickel and white textile shade.

Familia formada por aplique,
sobremesa, pie y colgante de
3 pantallas. Su estructura es
níquel mate y su pantalla textil
en color blanco.

Collection pour éclairage inte-
rieur: applique, lampe de table
et de pied et suspension. En
nickel mat et abat jour blanc.





wall lamp

68532



matt nickel+white
níquel mate+blanco

1XE14 MAX 40W NOT INCL. [I6321] [LED I7451]

METAL + TEXTILE /
METAL + TÈXTIL

A++ to E / 100-240V ~ 50-60 Hz / 0.8 kg / 1.76 lb

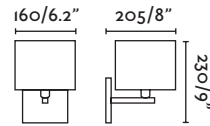

TELESCOPIC
TELESCÓPICO

pendant lamp

68533



matt nickel+white
níquel mate+blanco

3XE27 MAX 40W NOT INCL. [I6292] [LED I7453]

METAL + TEXTILE /
METAL + TÈXTIL

A++ to E / 100-240V ~ 50-60 Hz / 3.04 kg / 6.70 lb

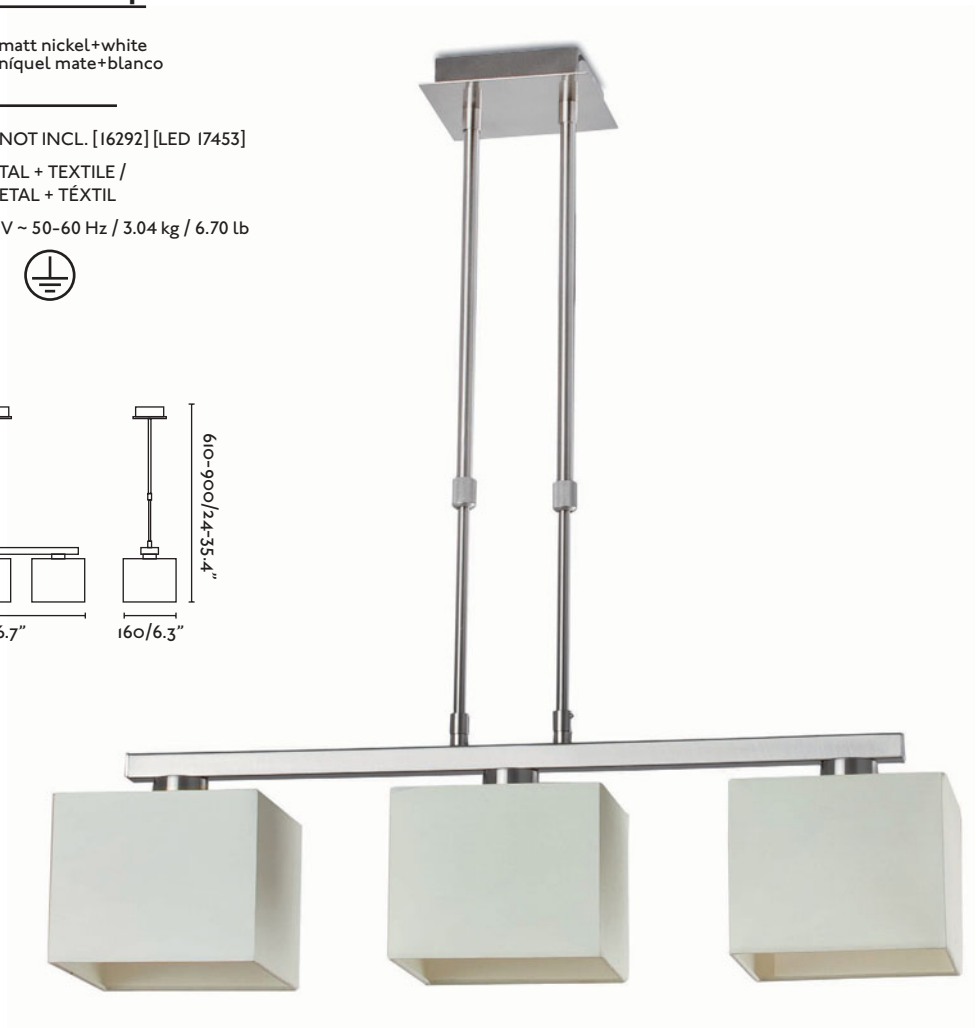
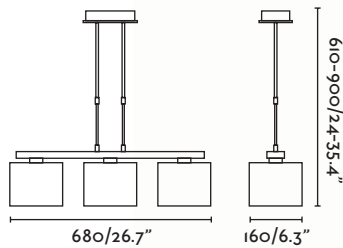

tHana



FABRIC SHADES

The fibre or fabric shades offer a warm, comfortable light.

Las pantallas de tela o fibra ofrecen una luz cálida y confortable.

Les écrans de toile ou de fibre offrent une lumière chaude et confortable.



floor lamp

68531



matt nickel+white
níquel mate+blanco

I XE27 MAX 100W NOT INCL. [I6167] [LED I7202]

METAL + TEXTILE /
METAL + TÉXIL

A++ to E / 100-240V ~ 50-60 Hz / 3.9 kg / 8.60 lb



table lamp

68530



matt nickel+white
níquel mate+blanco

I XE27 MAX 40W NOT INCL. [I6292] [LED I7453]

METAL + TEXTILE /
METAL + TÉXIL

A++ to E / 100-240V ~ 50-60 Hz / 1.3 kg / 2.87 lb



miTic

Mitic is an indoor collection made of steel and beige textile. Wall lamp, pendant, table lamp and floor lamp.

Mitic es de acero con pantalla textil en beige. Está formada por aplique, colgante, sobremesa y pie.

Mitic est une collection pour l'éclairage intérieur. Fabriquée en acier et textile. Applique, suspension, lampe de table et de pied.





pendant lamp

68419



matt nickel+beige
níquel mate+beige

1 X E27 MAX 60W NOT INCL. [16292]

METAL + TEXTILE /
METAL + TÉXTEL

A++ to E / 100-240V ~ 50-60 Hz / 1.7 kg / 3.75 lb

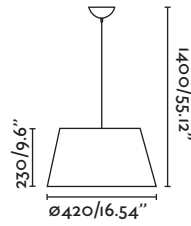

wall lamp

68420



matt nickel+beige
níquel mate+beige

1 X E14 MAX 60W NOT INCL. [16293]

METAL + TEXTILE /
METAL + TÉXTEL

A++ to E / 100-240V ~ 50-60 Hz / 1 kg / 2.20 lb

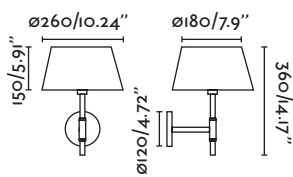

miTic



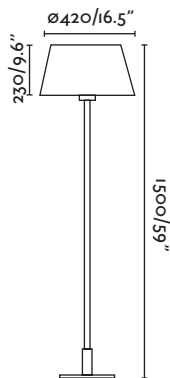
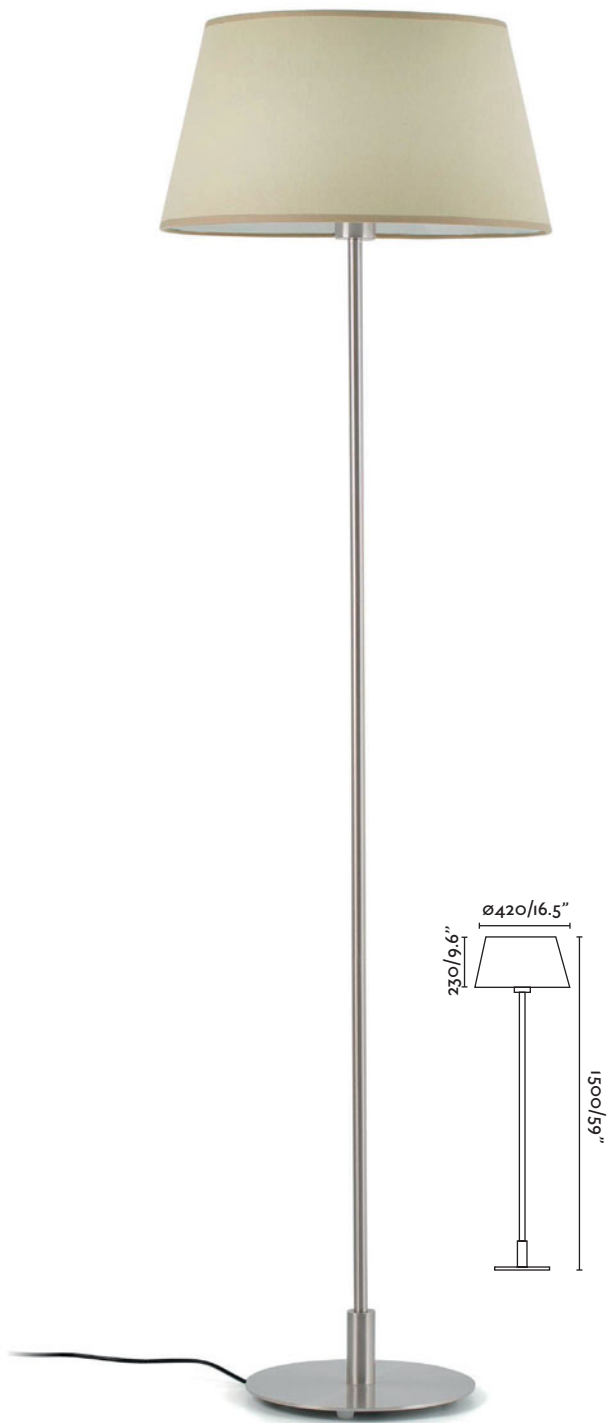

floor lamp

68418



matt nickel+beige
níquel mate+beige

I XE27 MAX 60W NOT INCL. [I6292] [LED I7202]

METAL + TEXTILE /
METAL + TÉXIL

A++ to E / 100-240V ~ 50-60 Hz / 4 kg / 8.82 lb

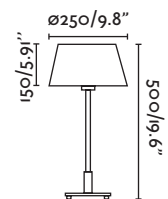

table lamp

68417



matt nickel+beige
níquel mate+beige

I XE14 MAX 60W NOT INCL. [I6239] [LED I7451]

METAL + TEXTILE /
METAL + TÉXIL

A++ to E / 100-240V ~ 50-60 Hz / 1.77 kg / 3.90 lb



LaRa [new]

Lara is a family with a metal frame in chrome and white fabric shade.

Lara es una familia con estructura de metal en cromo y pantalla textil en color blanco. Formada por aplique y colgantes.

Lara est une famille avec armature métallique en chrome et un écran de tissu blanc plissé.



[new] pendant lamp

67019



chrome+white
cromo+blanco

3XE14 MAX 40W NOT INCL. [I16294] [LED I7451]

METAL + TEXTILE /
METAL + TÉXIL

A++ to E / 100-240V ~ 50-60 Hz / 1.37 kg / 3.02 lb

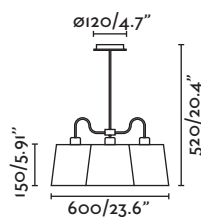

[new] wall lamp

67018



chrome+white
cromo+blanco

1XE I4 MAX 40W NOT INCL. [16294] [LED 17451]

METAL + TEXTILE /
METAL + TÉXIL

A++ to E / 100-240V ~ 50-60 Hz / 0.18 kg / 0.40 lb

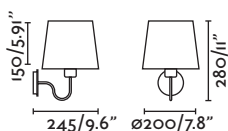

[new] pendant lamp

67020



chrome+white
cromo+blanco

5XE I4 MAX 40W NOT INCL. [16294] [LED 17451]

METAL + TEXTILE /
METAL + TÉXIL

A++ to E / 100-240V ~ 50-60 Hz / 1.94 kg / 4.28 lb

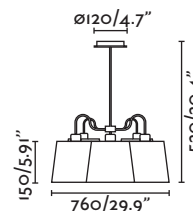

rlo

Rio is a family with a metal frame in chrome and white pleated fabric shade. Formed by wall lights, night lamps, foot lamps and hanging lamps with four or six screens.

Rio es una familia con estructura de metal en cromo y pantalla textil plisada en color blanco. Formada por aplique, sobremesa, pie y colgantes de cuatro y seis pantallas.

Rio est une famille avec armature métallique en chrome et un abat-jour de tissu blanc plissé. Formé d'applique, table, pied au sol et pendaison de quatre et six écrans.



wall lamp

67005



chrome+white
cromo+blanco

1 X E14 MAX 40W NOT INCL. [16294] [LED 17451]

METAL + TEXTILE /
METAL + TÊXTIL

A++ to E / 100-240V ~ 50-60 Hz / 1.1 kg / 2.43 lb

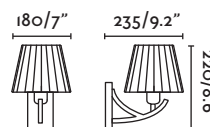



floor lamp

67007



chrome+white
cromo+blanco

1 XE27 MAX 60W NOT INCL. [I6219] [LED 17202]

METAL + TEXTILE /
METAL + TÉXTEL

A++ to E / 100-240V ~ 50-60 Hz / 8.2 kg / 18.08 lb



table lamp

67006



chrome+white
cromo+blanco

1 XE14 MAX 40W NOT INCL. [I6294] [LED 17451]

METAL + TEXTILE /
METAL + TÉXTEL

A++ to E / 100-240V ~ 50-60 Hz / 2.8 kg / 6.17 lb



rlo





pendant lamp

67008



chrome+white
cromo+blanco

4XE I4 MAX 40W NOT INCL. [I6294] [LED I7451]

METAL + TEXTILE /
METAL + T XTEL

A++ to E / 100-240V ~ 50-60 Hz / 3.8 kg / 8.38 lb

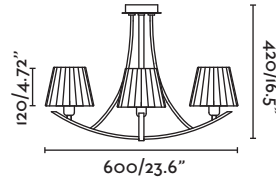

pendant lamp

67009



chrome+white
cromo+blanco

6XE I4 MAX 40W NOT INCL. [I6294] [LED I7451]

METAL + TEXTILE /
METAL + T XTEL

A++ to E / 100-240V ~ 50-60 Hz / 5.7 kg / 12.57 lb

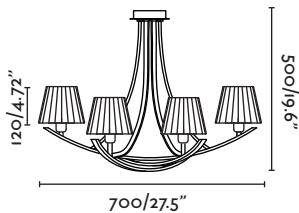

sAba

Saba has a double shade and a metal structure finished in matt nickel. Wall lamp, table lamps, floor lamp and pendant lamps.

Saba está formada por una doble pantalla y una estructura de metal en níquel mate. Formada por aplique, sobremesas, pie y colgantes.

Saba est a collection avec double abat-jour et une structure en métal. Applique, lampes de table et de pied, et suspensions.



CLASSIC STYLE

The perfect combination of classic and contemporary style that will give your home a modern look.

Perfecta combinación entre el estilo clásico y actual que dará un aspecto moderno a tu hogar.

Combinaison parfaite entre le style classique et actuel qui donnera un aspect moderne à votre maison.



wall lamp

68544



matt nickel
níquel mate

1 XE27 MAX 40W NOT INCL. [16292] [LED 17453]

METAL + TEXTILE /
METAL + TÉXTEL

A++ to E / 100-240V ~ 50-60 Hz / 1.6 kg / 3.53 lb

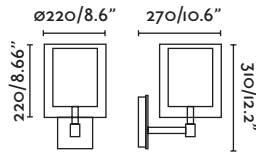

table lamp

68545



matt nickel
níquel mate

1 XE27 MAX 40W NOT INCL. [16292] [LED 17453]

METAL + TEXTILE /
METAL + TÉXTEL

A++ to E / 100-240V ~ 50-60 Hz / 1.8 kg / 3.97 lb

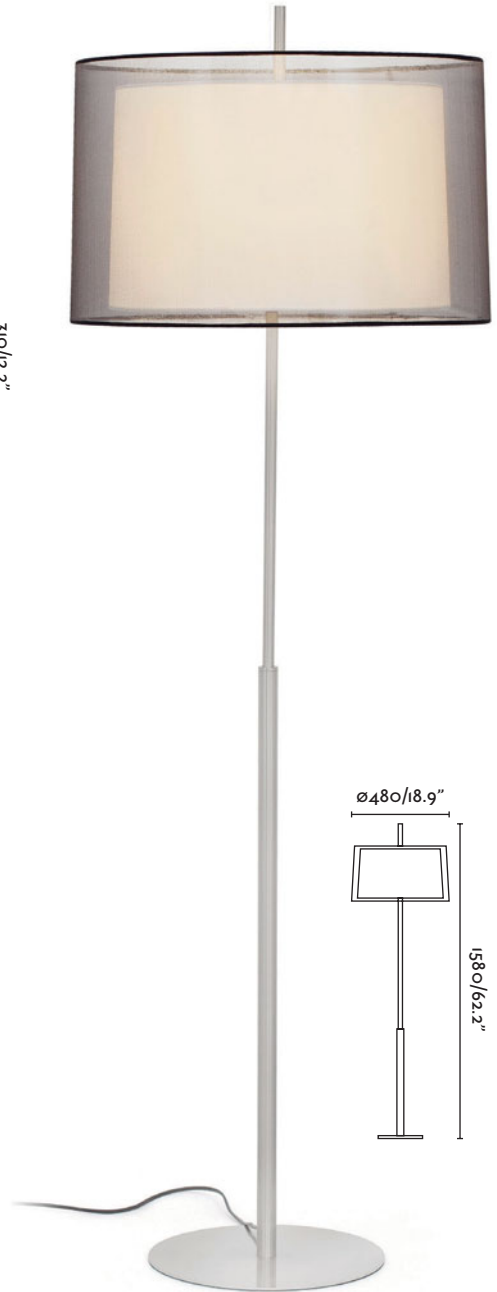
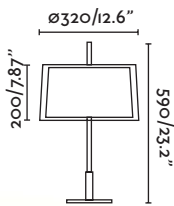

floor lamp

68547



matt nickel
níquel mate

1 XE27 MAX 60W NOT INCL. [16212] [LED 17202]

METAL + TEXTILE /
METAL + TÉXTEL

A++ to E / 100-240V ~ 50-60 Hz / 3.5 kg / 7.72 lb

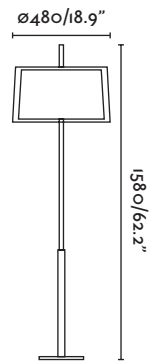

sAba



table lamp

68546

● matt nickel
níquel mate

1 X E27 MAX 40W NOT INCL. [16212] [LED 17452]

METAL + TEXTILE /
METAL + TÉXIL

A++ to E / 100-240V ~ 50-60 Hz / 1.8 kg / 3.97 lb

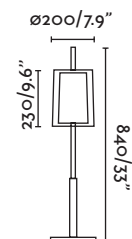



pendant lamp

68548

● matt nickel
níquel mate

1 XE27 MAX 40W NOT INCL. [16212] [LED 17453]

METAL + TEXTILE /
METAL + TÉXTEL

A++ to E / 100-240V ~ 50-60 Hz / 1.5 kg / 3.31 lb

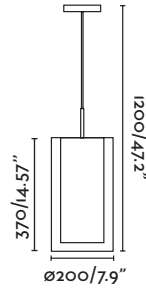

pendant lamp

68549

● matt nickel
níquel mate

3XE27 MAX 40W NOT INCL. [16212] [LED 17453]

METAL + TEXTILE /
METAL + TÉXTEL

A++ to E / 100-240V ~ 50-60 Hz / 2.2 kg / 4.85 lb

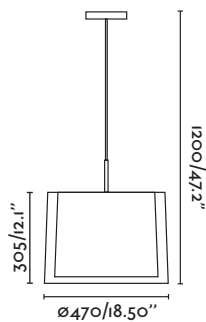

quO

Classical indoor lighting collection. Made from PVC for the shade and chrome metal for the structure. Table lamp, floor lamp and pendant lamp.

Familia de estilo clásico con pantalla de PVC y estructura de metal cromado. Formada por sobremesa, pie y colgante.

Collection classique pour l'éclairage intérieur. Fabriquée en PVC et métal chromé. Lampe de table et de pied, et suspension.



pendant lamp

66179



chrome
cromo

I XE27 MAX 60W NOT INCL. [16292] [LED 17202]

METAL + PVC /
METAL + PVC

A++ to E / 100-240V ~ 50-60 Hz / 2.2 kg / 4.85 lb

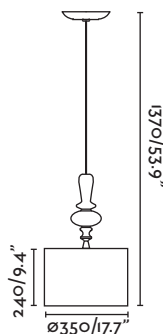



floor lamp

66178

chrome
cromo

1 XE27 MAX 60W NOT INCL. [I6292] [LED I7202]

METAL + PVC /
METAL + PVC

A++ to E / 100-240V ~ 50-60 Hz / 4.6 kg / 10.14 lb



table lamp

66177

chrome
cromo

1 XE27 MAX 60W NOT INCL. [I6292] [LED I7202]

METAL + PVC /
METAL + PVC

A++ to E / 100-240V ~ 50-60 Hz / 4.24 kg / 9.35 lb

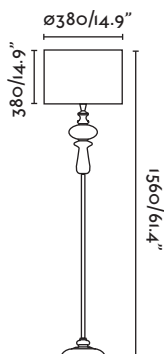
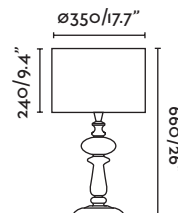

wiNch

by Manel Llusçà

Inspired by the gas lamps of the old fishing boats from the Mediterranean coast, it gives memories and calmness to all its surroundings.

Inspirada en las luces de gas de las antiguas barcas de pesca del litoral Mediterráneo, dota de nostalgia y calma a todo lo que la rodea.

Inspiré par les lampes à gaz des bateaux de pêche dantan qui naviguaient le long des côtes méditerranéennes, elle procure calme et nostalgie à son environnement.



pendant lamp

66204



pale brown
marrón pardo

1XE27 MAX 60W NOT INCL. [16166] [LED 17453]

METAL + GLASS /
METAL + CRISTAL

A++ to E / 100-240V ~ 50-60 Hz / 2.4 kg / 5.29 lb

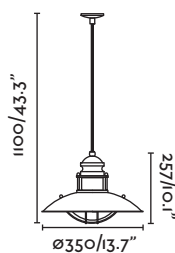



wall lamp

66200



pale brown
marrón pardo

1 XE27 MAX 60W NOT INCL. [I6166] [LED 17453]

METAL + GLASS /
METAL + CRISTAL

A++ to E / 100-240V ~ 50-60 Hz / 2.5 kg / 5.51 lb

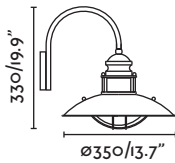

wall lamp

66201



pale brown
marrón pardo

1 XE27 MAX 60W NOT INCL. [I6166] [LED 17453]

METAL + GLASS /
METAL + CRISTAL

A++ to E / 100-240V ~ 50-60 Hz / 2.7 kg / 5.95 lb

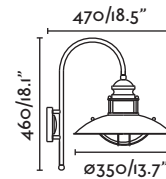

pendant lamp

66205



pale brown
marrón pardo

1 XE27 MAX 60W NOT INCL. [I6166] [LED 17453]

METAL + GLASS /
METAL + CRISTAL

A++ to E / 100-240V ~ 50-60 Hz / 5 kg / 11.02 lb

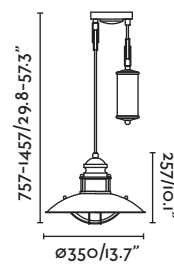

sAc

by Manel Luscà

The SAC family exudes a rustic feeling with a contemporary design combining a textured metal structure and a fabric shade that provides a soft, warm light.

La familia SAC destila un aire rústico con un diseño contemporáneo combinando una estructura en metal texturizado y una pantalla de tela que proporciona una luz cálida y suave.

La ligne SAC dégage quelque chose de rustique malgré son design contemporain alliant une structure en métal texturé et un abat-jour en tissu qui offre une lumière douce et chaude.



wall lamp

66190



dark brown+beige
marrón oscuro+beige

1 X E27 MAX 60W NOT INCL. [I6466] [LED I7453]

METAL + TEXTILE /
METAL + TÉXIL

A++ to E / 100-240V ~ 50-60 Hz / 1.13 kg / 2.49 lb

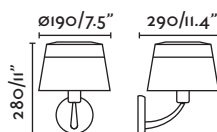

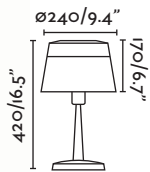

table lamp

66194



dark brown+beige
marrón oscuro+beige

1XE27 MAX 60W NOT INCL. [I6292] [LED 17453]

METAL + TEXTILE /
METAL + TÉXIL

A++ to E / 100-240V ~ 50-60 Hz / 2 kg / 4.41 lb

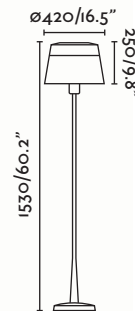

floor lamp

66195



dark brown+beige
marrón oscuro+beige

2XE27 MAX 60W NOT INCL. [I6167] [LED 17453]

METAL + TEXTILE /
METAL + TÉXIL

A++ to E / 100-240V ~ 50-60 Hz / 8.61 kg / 18.98 lb



sAc

by Manel Lusà



pendant lamp

OUT OF CATALOGUE
DESCATALOGADO

66193



dark brown+beige
marrón oscuro+beige

2XE27 MAX 60W NOT INCL. [I6167] [LED I7453]

METAL + TEXTILE /
METAL + TÈXTIL

A++ to E / 100-240V ~ 50-60 Hz / 4.3 kg / 9.48 lb

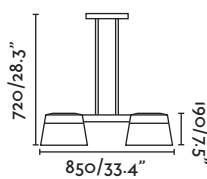

wall lamp

66191



dark brown+beige
marrón oscuro+beige

2XE14 MAX 60W NOT INCL. [16294] [LED 17451]

METAL + TEXTILE /
METAL + TÉXIL

A++ to E / 100-240V ~ 50-60 Hz / 0.8 kg / 1.76 lb

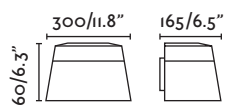

pendant lamp

66192



dark brown+beige
marrón oscuro+beige

3XE27 MAX 60W NOT INCL. [16167] [LED 17453]

METAL + TEXTILE + POLYCARBONATE /
METAL + TÉXIL + POLICARBONATO

A++ to E / 100-240V ~ 50-60 Hz / 5.15 kg / 11.35 lb

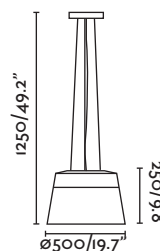

nuDos

Family of nautical-inspired lamps made of metal and wood. The diffuser is made of a glass bubble.

Familia de inspiración náutica realizada en metal y madera. El difusor es de cristal de burbuja.

Famille d'inspiration nautique fait de métal et de bois. Le diffuseur est une bulle de verre.



RUSTIC STYLE

Browns and ochres dominate the rustic style, combined with a rusted metal effect.

En el estilo rústico predominan los marrones y ocre, combinados con metales efecto óxido.

Dans le style rustique prédominent les marrons et les ocre, combinés avec des métaux à l'effet rouillé.



wall lamp

68138



dark brown
marrón oscuro

1 X E27 MAX 60W NOT INCL. [I6240] [LED 17452]

METAL + WOOD + BUBBLE GLASS /
METAL + MADERA + CRISTAL BURBUJA

A++ to E / 100-240V ~ 50-60 Hz / 1.3 kg / 2.87 lb

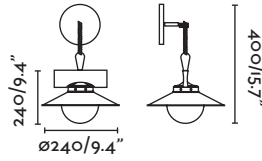

pendant lamp

68139



dark brown
marrón oscuro

1 X E27 MAX 60W NOT INCL. [I6240] [LED 17452]

METAL + WOOD + BUBBLE GLASS /
METAL + MADERA + CRISTAL BURBUJA

A++ to E / 100-240V ~ 50-60 Hz / 1.36 kg / 3.00 lb

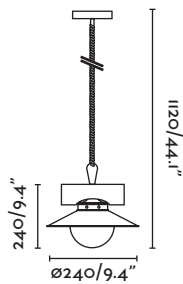

náPoles

Classical indoor lighting collection. Made from dark brown metal and glass. Wall lamps, surface and table lamp.

Familia clásica con tulipas de cristal. Realizada en metal marrón oscuro, está formada por apliques, superficie y sobremesa.

Collection classique pour l'éclairage intérieur. Fabriquée en noyer marron et verre. Appliques, surface et lampe de table.



wall lamp

66132



dark brown
marrón oscuro

1 X G9 MAX 40W NOT INCL. [I5615]

METAL + GLASS /
METAL + CRISTAL

A++ to E / 100-240V ~ 50-60 Hz / 0.7 kg / 1.54 lb



100/3.9"

200/7.9"

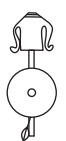

270/10.6"



wall lamp

66133



dark brown
marrón oscuro

2XG9 MAX 40W NOT INCL. [I5615] [LED 17440]

METAL + GLASS /
METAL + CRISTAL

A++ to E / 100-240V ~ 50-60 Hz / 1.03 kg / 2.27 lb

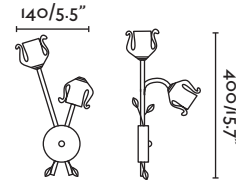

ceiling lamp

66134



dark brown
marrón oscuro

3XG9 MAX 40W NOT INCL. [I5615] [LED 17440]

METAL + GLASS /
METAL + CRISTAL

A++ to E / 100-240V ~ 50-60 Hz / 1.8 kg / 3.97 lb

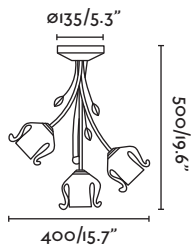

table lamp

66130



dark brown
marrón oscuro

1XG9 MAX 40W NOT INCL. [I5615] [LED 17440]

METAL + GLASS /
METAL + CRISTAL

A++ to E / 100-240V ~ 50-60 Hz / 1.5 kg / 3.31 lb



toRino

Classic family with glass tulips. Made of dark brown metal, formed by wall lights, hanging lamps, night lamps and foot lamps.

Familia clásica con tulipas de cristal. Realizada en metal marrón oscuro, está formada por apliques, colgantes, sobremesa y pie.

Famille classique avec des nuances de verre. En métal brun foncé, formé d'appliques, pendentifs, table et pied.





wall lamp

66091



dark brown
marrón oscuro

1 XG9 MAX 40W NOT INCL. [15615] [LED 17440]

METAL + GLASS /
METAL + CRISTAL

A++ to E / 100-240V ~ 50-60 Hz / 1 kg / 2.20 lb

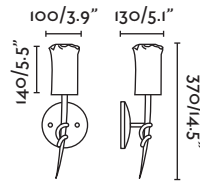

wall lamp

66092



dark brown
marrón oscuro

2 XG9 MAX 40W NOT INCL. [15615] [LED 17440]

METAL + GLASS /
METAL + CRISTAL

A++ to E / 100-240V ~ 50-60 Hz / 1.7 kg / 3.75 lb

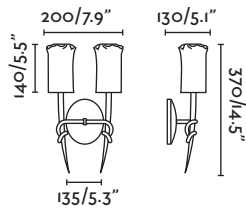

floor lamp

66095



dark brown
marrón oscuro

3XG9 MAX 40W NOT INCL. [I5615] [LED I7440]

METAL + GLASS /
METAL + CRISTAL

A++ to E / 100-240V ~ 50-60 Hz / 6 kg / 13.23 lb

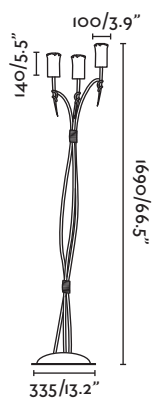



pendant lamp

66093

dark brown
marrón oscuro

4XG9 MAX 40W NOT INCL. [I5615] [LED I7440]

METAL + GLASS /
METAL + CRISTAL

A++ to E / 100-240V ~ 50-60 Hz / 4.9 kg / 10.80 lb

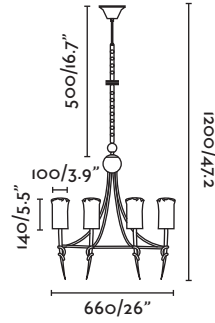

pendant lamp

66094

dark brown
marrón oscuro

6XG9 MAX 40W NOT INCL. [I5615] [LED I7440]

METAL + GLASS /
METAL + CRISTAL

A++ to E / 100-240V ~ 50-60 Hz / 6.6 kg / 14.55 lb

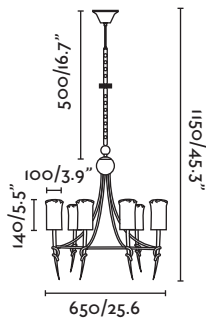



















table & floor lamps

sobremesas y lámparas de pie/lampes de table et de pied/lampade da tavolo e piantane

 akanE	114	 moNtana	126
 baNker	120	 nExo	122
 bLack	124	 niDia	121
 bLiss	119	 nOble	133
 cHapí	121	 papUa	127
 dlx	132	 rOma	125
 hAt	119	 sOul	130
 kAlen	121	 versUs	116
 liLium	128		
 lUla	112		





BLETA

& FLOOR LAMPS

table & floor lamps
sobremesas y lámparas de pie
Lampes de table et de pied
lampade da tavolo e piantane



LULa

by Marina Milà

Lula is a sculptural table lamp, light, with soft shapes, pleasant to look at and austere, without superfluous elements. Its simplicity gives it that beauty and style that characterizes its design.

Con aire escultórico, ligera, de formas suaves, agradable a la vista y austera, sin elementos superfluos. Su simplicidad le da esa belleza y estilo que caracteriza su diseño.

Lula est une lampe de table avec un air de sculpture, légère, aux formes douces, agréable à la vue et austère, sans éléments superflus. Sa simplicité lui donne la beauté et le style qui caractérisent son design.



table lamp

- 28380   white+white
blanco+blanco
- 28381   olive green+dark green
verde oliva+verde oscuro
- 28382   black+white
negro+blanco



1XE27 MAX 20W NOT INCL. [16177] [LED 17453]

METAL + TEXTILE /
METAL + TÉXIL

A++ to B / 100-240V ~ 50-60 Hz / 2.25 kg / 4.96 lb

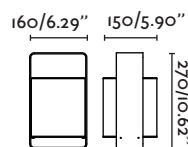

table lamp

- 28383   white+white
blanco+blanco
- 28384   olive green+dark green
verde oliva+verde oscuro
- 28385   black+white
negro+blanco

1XE27 MAX 20W NOT INCL. [16177] [LED 17453]

METAL + TEXTILE /
METAL + TÉXIL

A++ to B / 100-240V ~ 50-60 Hz / 2.32 kg / 5.11 lb

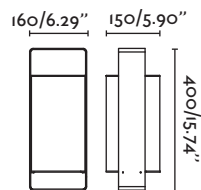

table & floor lamps
sobremesas y lámparas de pie
Lampes de table et de pied
Lampade da tavolo e piantane

akanE

by Pepe Lladet

Inspired by the most ancient oriental culture and reinterpreted to be converted into a contemporary object, Akane constantly surprises thanks to the minimalism of its useful structure.

Inspirada en la más ancestral cultura oriental, y reinterpretada para ser reconvertida en objeto contemporáneo, Akane sorprende por el minimalismo de su útil estructura.

Inspirée de la culture orientale la plus ancestrale, et réinterprétée pour se transformer en un objet contemporain, Akane vous surprendra par le minimalisme de sa structure utile.





MADE IN SPAIN
HECHO EN ESPAÑA

table lamp

28370 ●● black+beige
negro+beige

28371 ●● black+beige
negro+beige

1 X E27 MAX 20W NOT INCL. [16212] [LED 17202]

METAL + PAPYRUS /
METAL + PAPIRO

A++ to B / 100-240V ~ 50-60 Hz / 1.65 kg / 3.64 lb

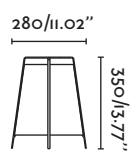

REF. 28370

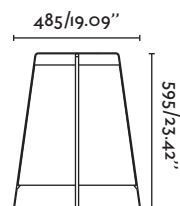

REF. 28371

table & floor lamps
sobremesas y lámparas de pie
Lampes de table et de pied
Lampade da tavolo e piantane

versUs

by Pepe Llaudet

Simple, easily-integrated and versatile. A contemporary object with a classic geometrical design formed from two conical elements of the same type and material.

Simple, integrable y versátil. Objeto contemporáneo y de geometría clásica que se forma a partir de dos elementos cónicos del mismo material y naturaleza.

Simple, facile à intégrer et polyvalente. Objet contemporain à la géométrie classique composé de deux éléments coniques du même matériau et de la même nature.





table lamp

29906



white
blanco

29907



white
blanco

I XE27 MAX 60W NOT INCL. [16166] [LED 17202]

TEXTILE /
TÉXTEL

A+++ to E / 100-240V ~ 50-60 Hz / 1 kg / 2.20 lb

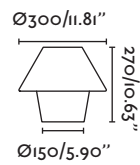

REF. 29906

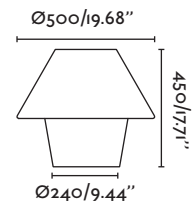

REF. 29907



TABLE LAMPS

Common in lounges, these table lamps give these small spaces their own light.

Habituales en salas de estar, las sobremesas dotan de luz propia a estos pequeños rincones.

Habituelles dans les salles à manger, les lampes de table offrent une lumière propre à ces petits coins.



hAt table lamp

28408



wood+white
madera+blanco

1 XE14 MAX 40W NOT INCL. [16239] [LED 17451]

WOOD + TEXTILE /
MADERA + TÉXTIL

A++ to E / 100-240V ~ 50-60 Hz / 0.7 kg / 1.54 lb

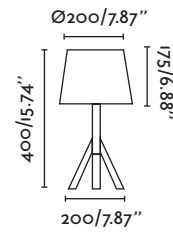

bLiss table lamp

28401



wood+white
madera+blanco

1 XE27 MAX 60W NOT INCL. [16219] [LED 17453]

WOOD + METAL + TEXTILE /
MADERA + METAL + TÉXTIL

A++ to E / 100-240V ~ 50-60 Hz / 1.58 kg / 3.48 lb

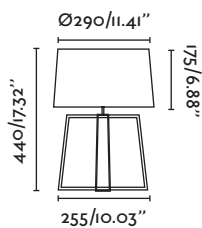



baNker table lamp

68333



bronze
bronce

68334



old gold
oro envejecido

1 X E27 MAX 60W NOT INCL. [I6322] [LED 17453]

METAL + GLASS /
METAL + CRISTAL

A++ to E / 100-240V ~ 50-60 Hz / 2.3 kg / 5.07 lb



260/10.23"



205/8.07"



375/14.76"





TOUCH LAMP
LAMPARA TACTIL

kAlen table lamp

68422

 matt nickel
níquel mate

1 XE I4 MAX 40W NOT INCL. [15602]

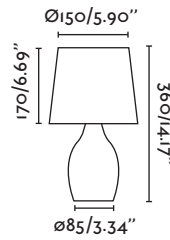

STAINLESS STEEL + SUEDE /
ACERO INOXIDABLE + ANTE

A++ to E / 100-240V ~ 50-60 Hz / 0.8 kg / 1.76 lb



niDia table lamp

68423

  matt nickel+beige
níquel mate+beige

1 XE27 MAX 40W NOT INCL. [16240] [LED 17451]

METAL + TEXTILE /
METAL + TÉXIL

A++ to E / 100-240V ~ 50-60 Hz / 0.9 kg / 1.98 lb

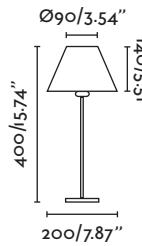

TOUCH LAMP
LAMPARA TACTIL

cHapí table lamp

29793

 chrome
cromo

29796

 chrome
cromo

LED 3W 3000K 140LM INCL.
ADAPTER AC INCL.

STAINLESS STEEL /
ACERO INOXIDABLE

A / 220-240V ~ 50 Hz / 1.1 kg / 2.43 lb

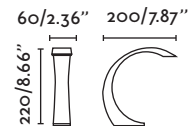

REF. 29793

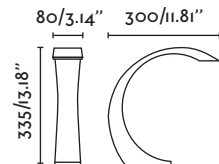

REF. 29796

table & floor lamps
sobremesas y lámparas de pie
Lampes de table et de pied
Lampade da tavolo e piantane

nExo

by Estudi Ribaudí

Nexo is an ambient light which incorporates a spotlight. Light flows through a single element that directs it in a gentle and balanced composition.

Nexo es una luz de ambiente que incorpora una luz puntual; estas fluyen por un único elemento que las ordena en una suave y equilibrada composición.



Nexo est un luminaire d'ambiance équipé d'un éclairage ponctuel. Un seul objet qui associe deux lumières en une composition douce et équilibrée.



OUT OF CATALOGUE
DESCATALOGADO



floor lamp+reader

- 57205**  matt nickel
níquel mate
- 57206**  white
blanco
- 57207**  black
negro



2XE27 MAX 15W NOT INCL. [I6292] [LED I7453]
1XG9 MAX 26W INCL. [LED I7440]

METAL + TRANSLUCENT GLASS /
METAL + CRISTAL TRANSLÚCIDO

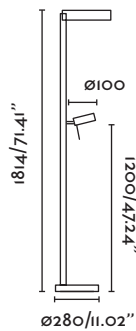
A++ to E / 100-240V ~ 50-60 Hz / 7.2 kg / 15.87 lb



floor lamp

- 57200**  matt nickel
níquel mate
- 57201**  white
blanco
- 57202**  black
negro

2XE27 MAX 15W NOT INCL. [I6292] [LED I7453]

METAL + TRANSLUCENT GLASS /
METAL + CRISTAL TRANSLÚCIDO

A++ to B / 100-240V ~ 50-60 Hz / 7.2 kg / 15.87 lb

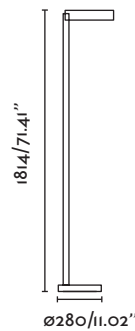

table & floor lamps
sobremesas y lámparas de pie
Lampes de table et de pied
Lampade da tavolo e piantane



bLack floor lamp

29764

● black
negro

1 X E27 MAX 60W NOT INCL. [16320] [LED 17202]

METAL + TEXTILE /
METAL + T XNIL

A++ to E / 100-240V ~ 50-60 Hz / 2.5 kg / 5.51 lb

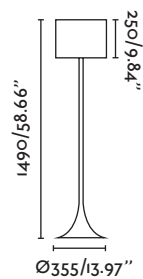



DIMMABLE
DIMABLE

rOma floor lamp

57068  white
blanco HF

57069  black
negro HF

COB LED 22W 3000K 2050LM CRI:80 INCL.
DRIVER INCL.

METAL /
METAL

A+ / 220-240V ~ 50-60 Hz / 8.5 kg / 18.74 lb

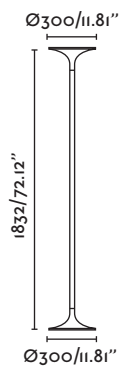

HF Until stock exhaustion
Hasta final de stock
Jusqu'à la fin de stock

table & floor lamps
sobremesas y lámparas de pie
Lampes de table et de pied
lampade da tavolo e piantane



moNtana floor lamp

57049



grey
gris

1 X E27 MAX 100W NOT INCL. [16167] [LED 17453]

METAL + POLYPROPYLENE /
METAL + POLIPROPILENO

A++ to E / 100-240V ~ 50-60 Hz / 4.5 kg / 9.92 lb



310/12.20"

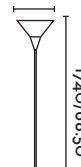

1740/68.50"

Ø260



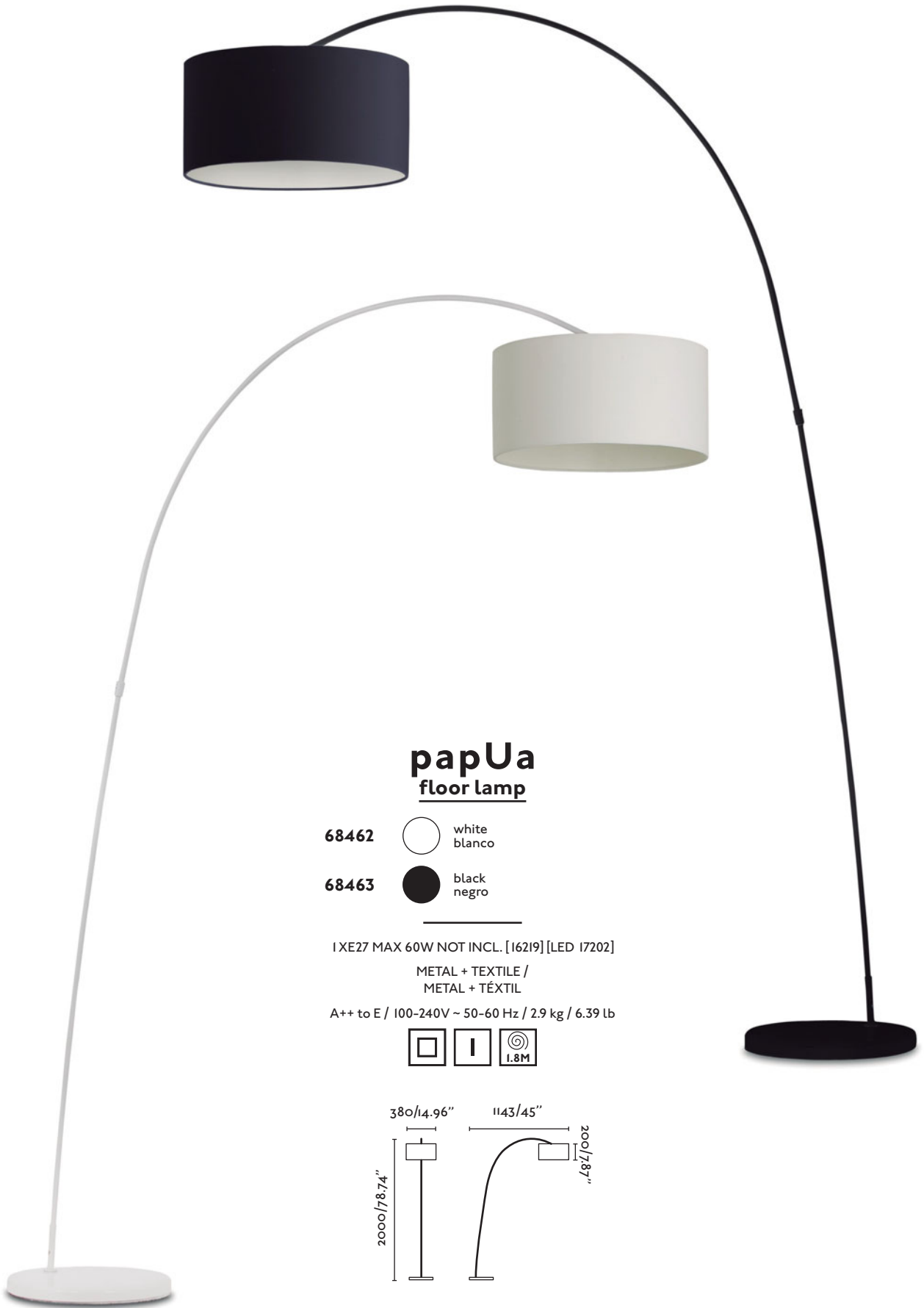

papUa
floor lamp

68462  white
blanco

68463  black
negro

1 X E27 MAX 60W NOT INCL. [16219] [LED 17202]

METAL + TEXTILE /
METAL + TÉXTIL

A++ to E / 100-240V ~ 50-60 Hz / 2.9 kg / 6.39 lb

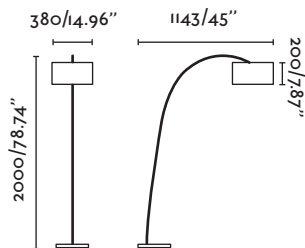



liLium floor lamp

68396



chrome
cromo

5XE I4 40W NOT INCL. [I5602]

MARBLE + METAL /
MÁRMOL + METAL

A++ to E / 100-240V ~ 50-60 Hz / 5.4 kg / 11.90 lb

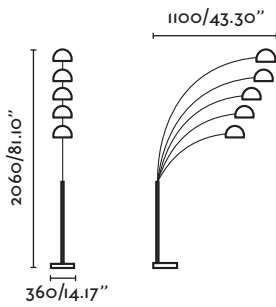



liLium floor lamp

68312



matt nickel
níquel mate

1 X E27 MAX 60W NOT INCL. [16212] [LED 17452]

MARBLE + METAL /
MÁRMOL + METAL

A++ to E / 100-240V ~ 50-60 Hz / 8.7 kg / 19.18 lb

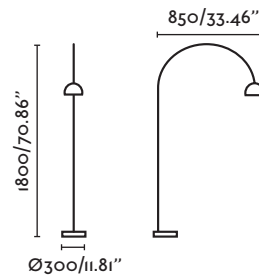

liLium floor lamp

68313



matt nickel
níquel mate

1 X E27 MAX 100W NOT INCL. [16212] [LED 17202]

MARBLE + METAL /
MÁRMOL + METAL

A++ to E / 100-240V ~ 50-60 Hz / 4.5 kg / 9.92 lb

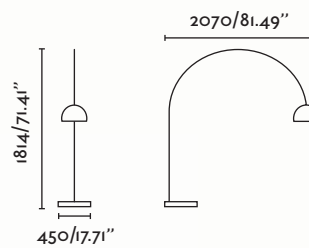

table & floor lamps
sobremesas y lámparas de pie
Lampes de table et de pied
lampade da tavolo e piantane





sOul
floor lamp

68559



chrome+white
cromo+blanco

1 X E27 MAX 60W NOT INCL. [16219] [LED 17202]

METAL + TEXTILE /
METAL + TÉXTIL

A++ to E / 100-240V ~ 50-60 Hz / 4.9 kg / 10.80 lb



sOul
table lamp

68558



chrome+white
cromo+blanco

1 X E27 MAX 60W NOT INCL. [16240] [LED 17453]

METAL + TEXTILE /
METAL + TÉXTIL

A++ to E / 100-240V ~ 50-60 Hz / 2.2 kg / 4.85 lb

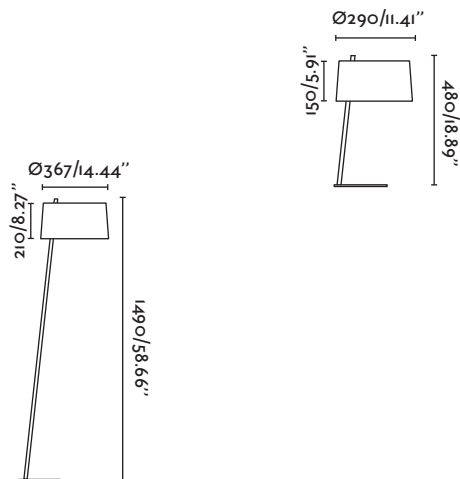



dlx
floor lamp

28407



black
negro

I XE27 MAX 60W NOT INCL. [16219] [LED 17202]

WOOD + TEXTILE /
MADERA + TÉXTIL

A++ to E / 100-240V ~ 50-60 Hz / 1.8 kg / 3.97 lb

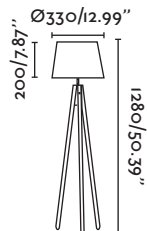

dlx
table lamp

28406



black
negro

I XE14 MAX 40W NOT INCL. [16239] [LED 17451]

WOOD + TEXTILE /
MADERA + TÉXTIL

A++ to E / 100-240V ~ 50-60 Hz / 0.8 kg / 1.76 lb

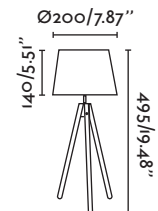



nOble
structure

29831  chrome
cromo

STEEL /
ACERO

A++ to E / 100-240V ~ 50-60 Hz / 10.5 kg / 23.15 lb

shade

29831B  white
blanco

29831P  black
negro

2XE27 MAX 60W NOT INCL. [16167] [LED 17202]

TEXTILE /
TÉXIL

A++ to E / 0.5 kg / 1.10 lb

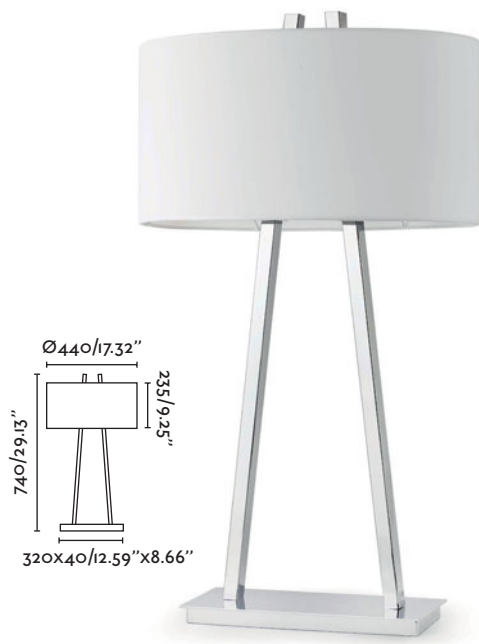

nOble
structure

29830  chrome
cromo

STEEL /
ACERO

A++ to E / 100-240V ~ 50-60 Hz / 1.14 kg / 2.51 lb

shade

29830B  white
blanco

29830P  black
negro

2XE27 MAX 60W NOT INCL. [16167] [LED 17453]





























TEXTILE /
TÉXIL

A++ to E / 0.4 kg / 0.88 lb



suspended

colgantes/suspensions/sospensioni

 aldEr	163	 óLEo	167
 alumiNio	164	 pAm	161
 aRt	141	 paPillon [new]	136
 bAr	163	 pérgAmo	155
 boNgo	166	 plAtillo	165
 ciLo	165	 pLuma	138
 cráTer	149	 proSa	153
 hAlita [new]	141	 sEven	151
 haNs	145	 siRia	167
 lUce [new]	145	 siSmo	147
 maGma	146	 sQuad	159
 maLi	150	 tavErn	143
 maRgot [new]	143	 teMpo	160
 miA	153	 tHym	157
 mUrano	144	 timbaL	169
 nAn [new]	159	 tranSfer	169
 naNko	149		
 nldo	155		
 nitrO	167		

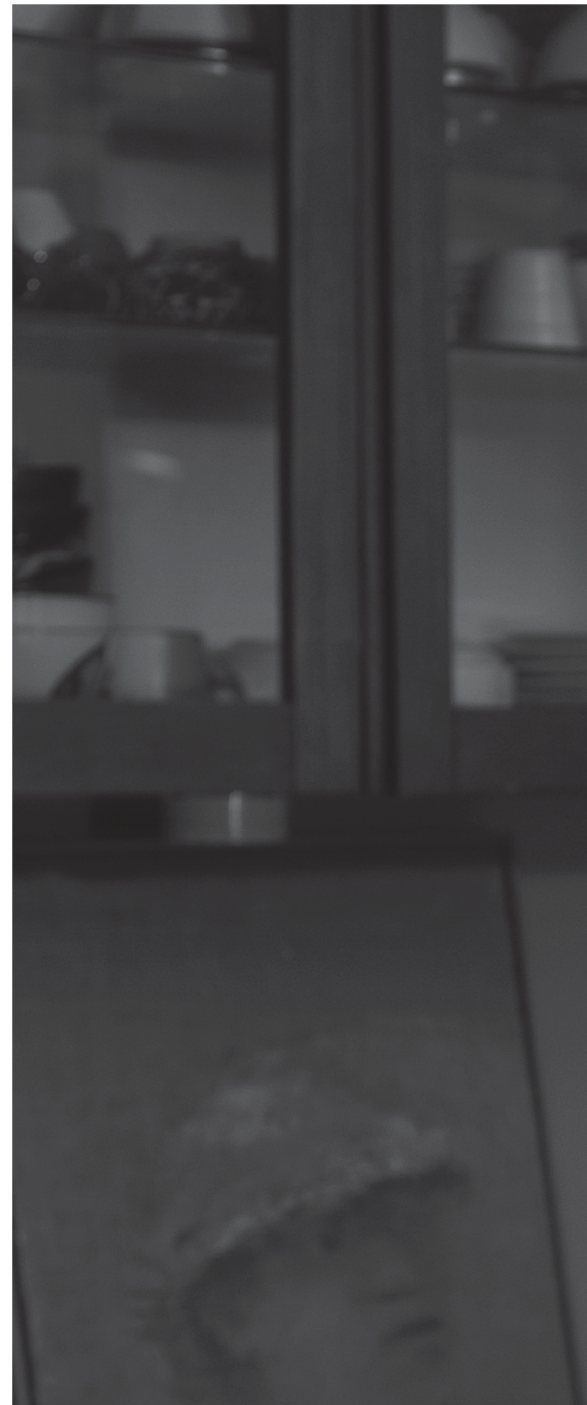

SUSPENDED



suspended
colgantes
suspensions
sospensioni



paPillon [new]

by Jordi Busquets

An elegant suspension. Perfect for environments with different lighting requirements.

Una suspensión elegante. Perfecta para ambientes con diferentes exigencias de iluminación.

Suspension élégante. Parfaits pour les environnements avec des exigences d'éclairage différents.



[new] pendant lamp-g

29296 ○ white
blanco

29297 ● black
negro

1 X T5 14W NOT INCL. [97400014]
GEAR INCL.

ALUMINIUM + OPAL POLYCARBONATE /
ALUMINIO + POLICARBONATO OPAL

A++ to B / 220-240V ~ 50-60 Hz / 5.01 kg / 11.05 lb

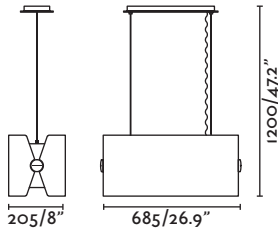

ADJUSTABLE SHADE
PANTALLA REGULABLE



[new] pendant lamp-p

29294 ○ white
blanco

29295 ● black
negro

2 X E27 50W NOT INCL. [16167] [LED 17453]

ALUMINIUM + OPAL POLYCARBONATE /
ALUMINIO + POLICARBONATO OPAL

A++ to B / 100-240V ~ 50-60 Hz / 3.61 kg / 7.96 lb

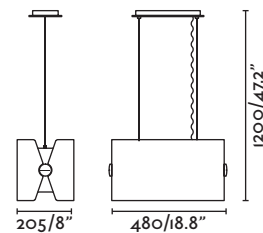

pLuma

by Nahrang

Pluma is a delicate piece and discreet piece hanging from the ceiling, evoking a simple expression of detail. With a very light shape, the main body casts a small vertical slit through which a suggestive light comes out.

Pluma es una pieza tan delicada como discreta. De forma muy ligera, el cuerpo principal proyecta una pequeña rendija vertical por donde se escapa la luz de forma sugerente.

Pluma est une pièce aussi délicate que discrète qui tombe du plafond en évoquant une simple expression de détail. De forme très légère, le corps principal projette une petite fente verticale par laquelle s'échappe la lumière de forme suggestive.



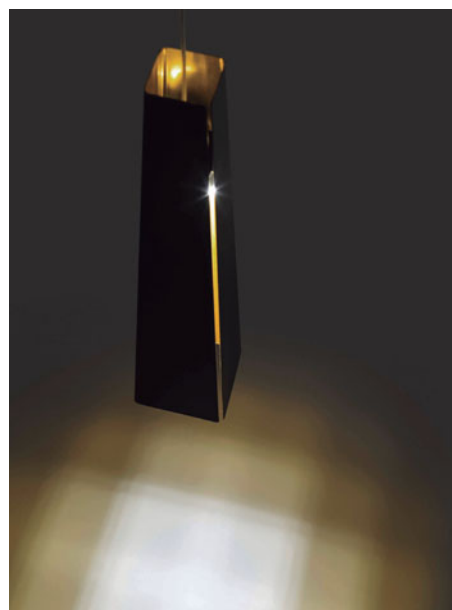

pendant lamp

64170



white+white
blanco+blanco

64172



black+gold
negro+oro

SMD LED 6W 3000K 450LM INCL.
DRIVER INCL.

ALUMINIUM /
ALUMINIO

A++ to A / 220-240V ~ 50-60 Hz / 0.6 kg / 1.32 lb



DRIVER 

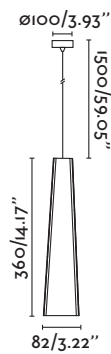





aRt pendant lamp

64137



old gold
oro envejecido

1XE27 MAX 60W NOT INCL. [10314]
STEEL + DIE CAST ALUMINIUM + TEXTILE/
ACERO + ALUMINIO INYECTADO + TÉXTEL
A++ to E / 100-240V ~ 50-60 Hz / 0.46 kg / 1.01 lb

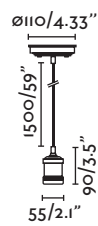

[new] hAlita pendant lamp

65071



old gold+black
oro envejecido+negro

1XE27 MAX 60W NOT INCL. [10310]
METAL + GLASS /
METAL + CRISTAL
A++ to E / 100-240V ~ 50-60 Hz / 1.14 kg / 2.51 lb

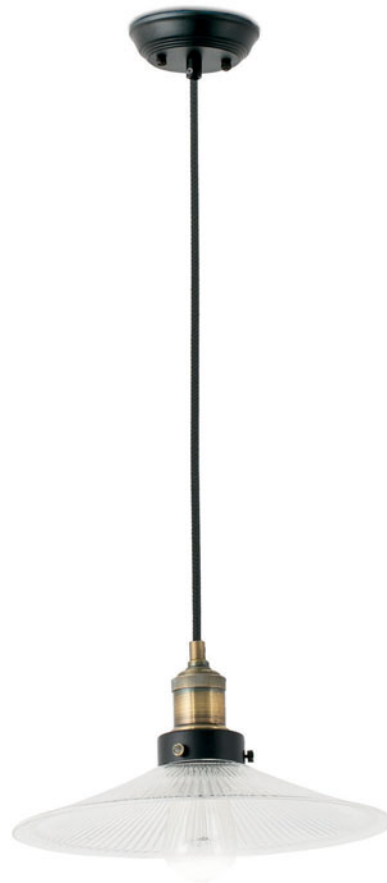
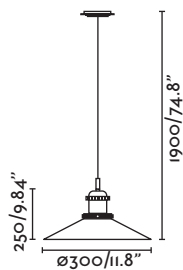



tavErn pendant lamp

68144



brown + beige
marrón + beige

1 X E27 MAX 60W NOT INCL. [16219] [LED 17453]

METAL /
METAL

A++ to E / 100-240V ~ 50-60 Hz / 1.6 kg / 3.53 lb

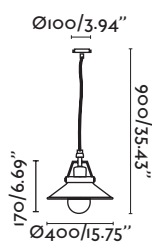

[new] maRgot pendant lamp

68561



black
negro

1 X E27 MAX 25W NOT INCL. [16219] [LED 17202]

METAL + WOOD /
METAL + MADERA

A++ to E / 100-240V ~ 50-60 Hz / 2.13 kg / 4.70 lb

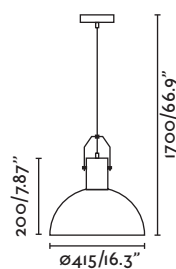



mUrano pendant lamp

29293

● black
negro

16XE I4 MAX 60W NOT INCL. [I6239] [LED 17451]

METAL + TEXTILE + GLASS /
METAL + TÉXTIL + CRISTAL

A++ to E / 100-240V ~ 50-60 Hz / 24.5 kg / 54.01 lb

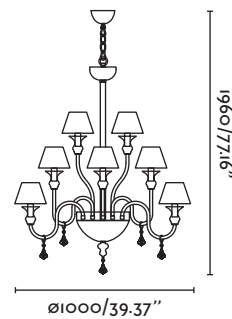



haNs pendant lamp

29664



1 X E27 MAX 60W NOT INCL. [16212] [LED 17453]

ALUMINIUM /
ALUMINIO

A++ to E / 100-240V ~ 50-60 Hz / 0.9 kg / 1.98 lb

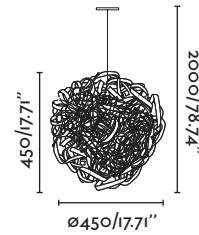

[new] lUce pendant lamp

64176



SMD LED 35W 2700K 2400LM INCL.
DRIVER INCL.

ALUMINIUM + OPAL PMMA /
ALUMINIO + PMMA OPAL

A / 220-240V ~ 50-60 Hz / 2.9 kg / 6.39 lb

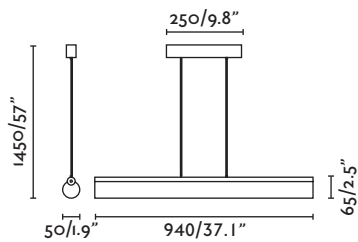



maGma pendant lamp-g

29789



black+gold
negro+oro

5XE27 MAX 40W NOT INCL. [16212] [LED 17202]





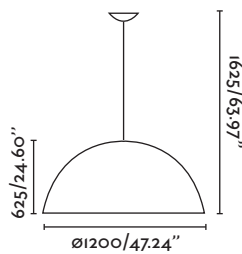

FIBER GLASS /
FIBRA DE VIDRIO

A++ to E / 100-240V ~ 50-60 Hz / 22 kg / 48.50 lb





maGma pendant lamp-p

- 28398   white+silver
blanco+plata
- 28399   white+gold
blanco+oro
- 29468   black+gold
negro+oro

3XE27 MAX 60W NOT INCL. [16212] [LED 17202]

FIBER GLASS /
FIBRA DE VIDRIO

A++ to E / 100-240V ~ 50-60 Hz / 8.2 kg / 18.08 lb

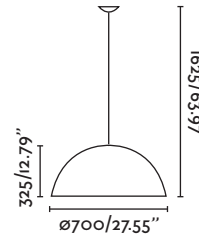

siSmo pendant lamp

- 29238   black+gold
negro+oro

1XT5 22W INCL.
GEAR INCL.

RESINE + OPAL POLYCARBONATE /
RESINA + POLICARBONATO OPAL

A to B / 220-240V ~ 50-60 Hz / 5.3 kg / 11.68 lb



- 29239   black+gold
negro+oro

OUT OF CATALOGUE
DESCATALOGADO

1XT5 32W INCL.
GEAR INCL.

RESINE + OPAL POLYCARBONATE /
RESINA + POLICARBONATO OPAL

A to B / 220-240V ~ 50-60 Hz / 5.3 kg / 11.68 lb

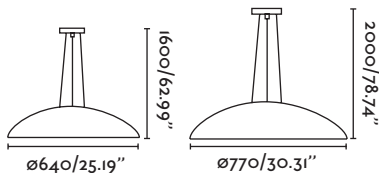

REF. 29238

REF. 29239



SUSPENSION

Some pendant models have the ability to decorate a large space.

Algunos modelos de suspensión tienen la capacidad de decorar un gran espacio.

Certains modèles de lampes suspendues ont la capacité de décorer un grand espace.



naNko pendant lamp

64139  white
blanco

64145  black
negro

1XE27 MAX 60W NOT INCL. [16212] [LED 17202]

ALUMINIUM + TEFLON /
ALUMINIO + TEFLÓN

A++ to E / 100-240V ~ 50-60 Hz / 2.3 kg / 5.07 lb

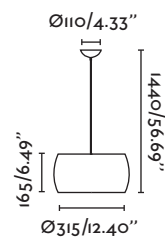

cráTer pendant lamp

68461   black+gold
negro+oro

3XE27 MAX 40W NOT INCL. [16212] [LED 17202]

ALUMINIUM /
ALUMINIO

A++ to E / 100-240V ~ 50-60 Hz / 4.3 kg / 9.48 lb

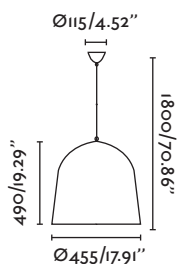



maLi pendant lamp-p

66872



white
blanco

1 XE27 MAX 60W NOT INCL. [16292] [LED 17202]

METAL + PVC /
METAL + PVC

A++ to E / 100-240V ~ 50-60 Hz / 1.45 kg / 3.20 lb

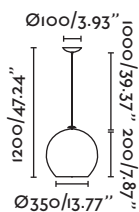

maLi pendant lamp-g

66873



white
blanco

1 XE27 MAX 60W NOT INCL. [16292] [LED 17202]

METAL + PVC /
METAL + PVC

A++ to E / 100-240V ~ 50-60 Hz / 1.9 kg / 4.19 lb

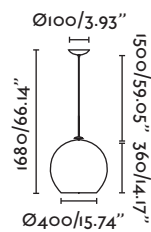



sEven pendant lamp-p

68283  white
blanco

2XE27 MAX 60W NOT INCL. [I6166] [LED I7453]

METAL + TEXTILE + PVC /
METAL + TÉXIL + PVC

A++ to E / 100-240V ~ 50-60 Hz / 2.1 kg / 4.63 lb

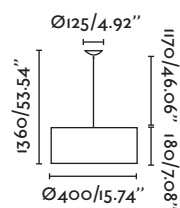

sEven pendant lamp-g

68284  white
blanco

68285  bordeaux
burdeos

68286  chocolate brown
marrón chocolate

3XE27 MAX 60W NOT INCL. [I6166] [LED I7453]

METAL + TEXTILE + PVC /
METAL + TÉXIL + PVC

A++ to E / 100-240V ~ 50-60 Hz / 2.1 kg / 4.63 lb

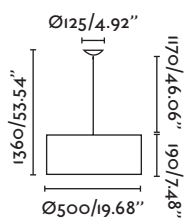





miA pendant lamp

64175



SMD LED 8W 3000K 600LM INCL.
DRIVER INCL.

METAL + OPAL GLASS /
METAL + CRISTAL OPAL

A+ / 100-240V ~ 50-60 Hz / 1.95 kg / 4.30 lb

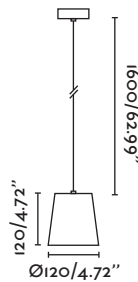

proSa pendant lamp

68535



3XE27 MAX 60W NOT INCL. [16166] [LED 17453]

METAL + TEXTILE + OPAL GLASS /
METAL + TÈXTIL + CRISTAL OPAL

A++ to E / 100-240V ~ 50-60 Hz / 5.75 kg / 12.68 lb

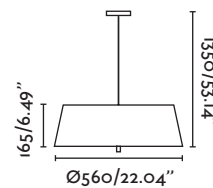

pérgAmo

by Faro Team



pérgAmo

by Faro Team

pendant lamp

29300



beige+black
beige+negro

3XE27 MAX 60W NOT INCL. [16167] [LED 17453]

STEEL + ACRYLIC + PARCHMENT /
ACERO + ACRÍLICO + PERGAMINO

A++ to E / 100-240V ~ 50-60 Hz / 1.33 kg / 2.93 lb

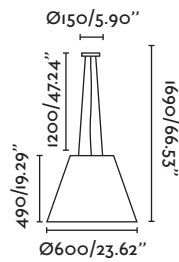

nido

pendant lamp

68153



orange brown
marrón anaranjado

1XE27 MAX 60W NOT INCL. [16167] [LED 17453]

METAL + RATTAN /
METAL + RATTAN

A++ to E / 100-240V ~ 50-60 Hz / 3.41 kg / 7.52 lb

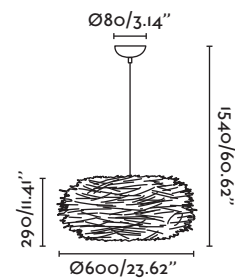





tHym pendant lamp

67016



honey
miel

HF

4XE I4 MAX 40W NOT INCL. [I632I] [LED I745I]

WOOD + METAL + TEXTILE /
MADERA + METAL + TÉXTIL

A++ to E / 100-240V ~ 50-60 Hz / 3.7 kg / 8.16 lb

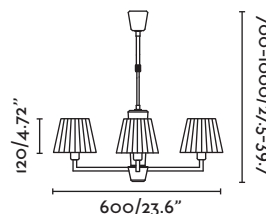

tHym pendant lamp

67017



honey
miel

OUT OF CATALOGUE
DESCATALOGADO

4XE I4 MAX 40W NOT INCL. [I632I] [LED I745I]

WOOD + METAL + TEXTILE /
MADERA + METAL + TÉXTIL

A++ to E / 100-240V ~ 50-60 Hz / 3.5 kg / 7.72 lb

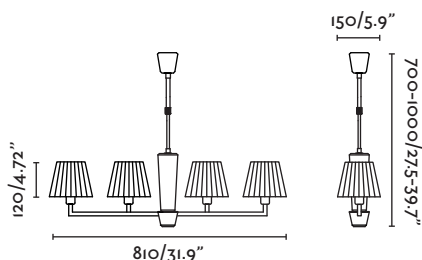

HF

Until stock exhaustion
Hasta final de stock
Jusqu'à la fin de stock

suspended
colgantes
suspensions
sospensioni



[new] nAn
pendant lamp

64191  white
blanco

1 X GU10 MAX 50W NOT INCL. [LED 14140]

ALUMINIUM /
ALUMINIO

A++ to E / 100-240V ~ 50-60 Hz / 0.51 kg / 1.12 lb

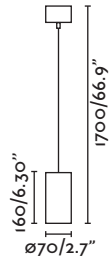

sQuad
pendant lamp

63219  matt white
blanco mate

63220  matt white
blanco mate

1 X GU10 MAX 35W NOT INCL. [LED 14140]

ALUMINIUM + STEEL /
ALUMINIO + ACERO

A++ to E / 100-240V ~ 50-60 Hz / 0.75 kg / 1.65 lb

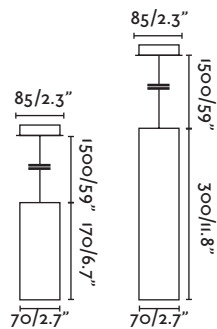







REF. 63219

REF. 63220





teMpo pendant lamp

- 64152   white+ white
blanco+ blanco
- 64153   black+gold
negro+oro
- 64154   black+silver
negro+plata

SMD LED 8W 3000K 600LM INCL.
DRIVER INCL.

ALUMINIUM /
ALUMINIO

A++ / 100-240V ~ 50-60 Hz / 0.4 kg / 0.88 lb

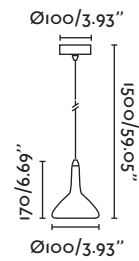



pAm pendant lamp-p

- 64159   white+ white
blanco+ blanco
- 64160   black+gold
negro+oro

SMD LED 11W 3000K 900LM INCL.
DRIVER INCL.
ALUMINIUM /
ALUMINIO
A++ / 100-240V ~ 50-60 Hz / 0.7 kg / 1.54 lb

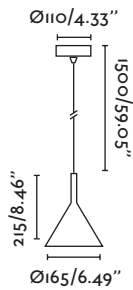

pAm pendant lamp-g

- 64161   white+ white
blanco+ blanco
- 64162   black+gold
negro+oro

SMD LED 24W 3000K 1875LM INCL.
DRIVER INCL.
ALUMINIUM /
ALUMINIO
A++ / 100-240V ~ 50-60 Hz / 0.61 kg / 1.34 lb

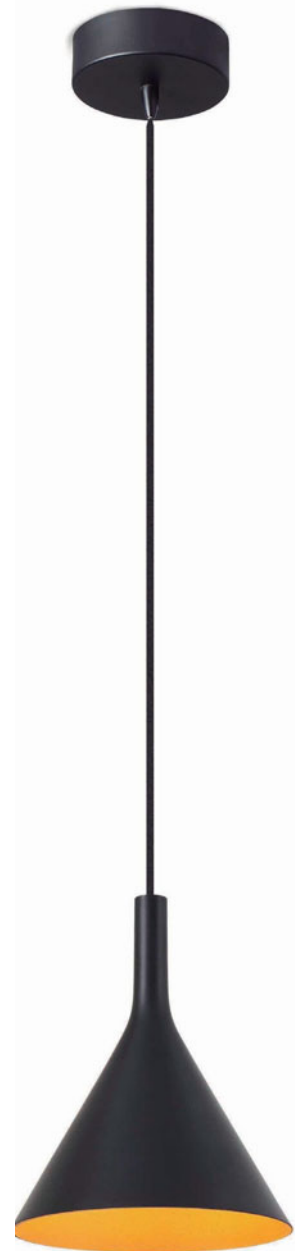
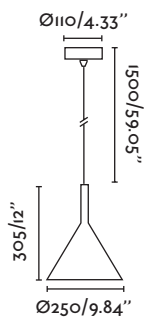



KITCHEN

Installing ceiling lamps in your kitchen's office will allow you to increase its functionality and comfort.

Instalar suspensiones en el office de tu cocina te permitirá aumentar su funcionalidad y confort.

Installer des lampes suspendues dans votre cuisine vous permettra d'augmenter sa fonctionnalité et son confort.



bAr pendant lamp

64132



white
blanco

1 XE27 MAX 60W NOT INCL. [16215] [LED 17202]

STEEL /
ACERO

A++ to E / 100-240V ~ 50-60 Hz / 1.3 kg / 2.87 lb

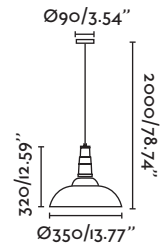

aldEr pendant lamp

64140



white
blanco

64141



black
negro

64142



red
rojo

1 XE27 MAX 60W NOT INCL. [16292] [LED 17453]

ALUMINIUM /
ALUMINIO

A+++ to E / 100-240V ~ 50-60 Hz / 0.7 kg / 1.54 lb

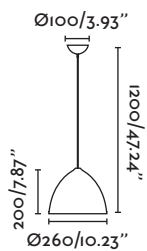



alumiNio pendant lamp

64100



matt nickel
níquel mate

1 XE27 MAX 75W NOT INCL. [16322] [LED 17453]

ALUMINIUM /
ALUMINIO

A++ to E / 100-240V ~ 50-60 Hz / 0.68 kg / 1.50 lb

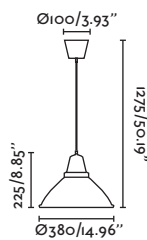



plAtillo pendant lamp

64109



matt nickel
níquel mate

1 X E27 MAX 60W NOT INCL. [16219] [LED 17453]

ALUMINIUM /
ALUMINIO

A++ to E / 100-240V ~ 50-60 Hz / 0.54 kg / 1.19 lb

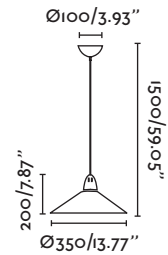

ciLo pendant lamp

64102



matt nickel
níquel mate

1 X E27 MAX 60W NOT INCL. [16322] [LED 17453]

ALUMINIUM /
ALUMINIO

A++ to E / 100-240V ~ 50-60 Hz / 0.48 kg / 1.06 lb



Ø100/3.93"

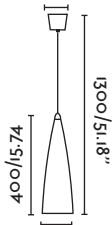

alumiNio pendant lamp

64101



matt nickel
níquel mate

1 X E27 MAX 75W NOT INCL. [16322] [LED 17453]

ALUMINIUM /
ALUMINIO

A++ to E / 100-240V ~ 50-60 Hz / 0.42 kg / 0.93 lb

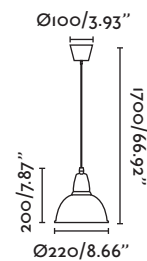



boNgo pendant lamp

64108



matt nickel
níquel mate

1XE27 MAX 60W NOT INCL. [I16322] [LED I7453]

ALUMINIUM /
ALUMINIO

A++ to E / 100-240V ~ 50-60 Hz / 1.6 kg / 3.53 lb

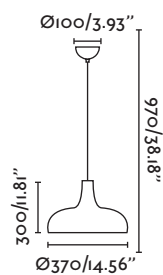



siRia pendant lamp

64104  matt nickel
níquel mate

1 X E27 MAX 60W NOT INCL. [I6322] [LED I7202]

ALUMINIUM + GLASS /
ALUMINIO + CRISTAL

A++ to E / 100-240V ~ 50-60 Hz / 2.4 kg / 5.29 lb

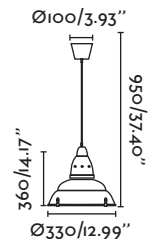

nitro pendant lamp

64125  matt nickel
níquel mate

1 X E27 MAX 60W NOT INCL. [I6167] [LED I7202]

ALUMINIUM + GLASS /
ALUMINIO + CRISTAL

A++ to E / 100-240V ~ 50-60 Hz / 3.3 kg / 7.28 lb

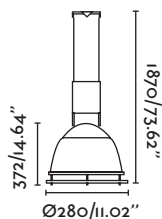

óleo pendant lamp

64129  matt nickel
níquel mate

1 X E27 MAX 100W NOT INCL. [I6155] [LED I7200]

ALUMINIUM + GLASS /
ALUMINIO + CRISTAL

A++ to E / 100-240V ~ 50-60 Hz / 5.1 kg / 11.24 lb

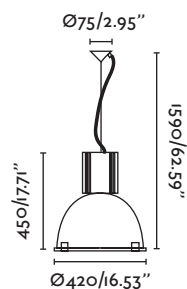





tranSfer pendant lamp

64131

● matt nickel
níquel mate

3XE27 MAX 60W NOT INCL. [I16164] [LED 17060]

DIE CAST ALUMINIUM + PMMA /
ALUMINIO INYECTADO + PMMA

A++ to E / 100-240V ~ 50-60 Hz / 3 kg / 6.61 lb

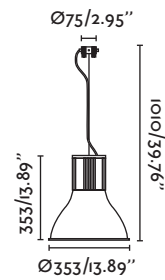

timbaL pendant lamp

64120

● matt nickel
níquel mate

1XE40 MAX 400W NOT INCL.
GEAR INCL.





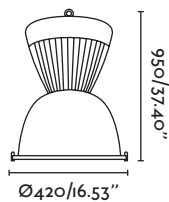



ALUMINIUM + GLASS /
ALUMINIO + CRISTAL

A++ to E / 220-240V ~ 50-60 Hz / 12 kg / 26.46 lb



spotlights

focos/spots/faretti

 áLAmo	189	 miKa	186
 blAt	185	 riNg	172
 boReal	179	 sTar	195
 dRaco	193	 tubA	182
 eRis	177	 tuRbo	199
 galAxia	180	 yUri	175
 luNe	200		



SPOTLIGHTS



riNg

by Manel Llusçà



Spotlights line with a classical multi-jointed mixture of colours with chrome, giving the collection a certain retro car style.

Línea de focos, con multi-articulado clásico y mezcla de colores con cromo, que dan a la colección cierto aire automovil-retro.

Ligne de spots, avec multiarticulé classique et mélange de couleurs et chrome qui donnent à la collection un air de voitures rétro.



spotlight

- 40550  white
blanco
- 40551  dark grey
gris oscuro
- 40552  matt nickel
níquel mate

1 XGU10 LED MAX 8W NOT INCL. [LED 14140]

METAL /
METAL

A++ to B / 100-240V ~ 50-60 Hz / 0.35 kg / 0.77 lb



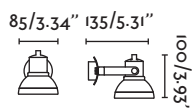

ONLY WITH LED / USO EXCLUSIVO LED





[new] ceiling lamp

- 40559  white
blanco
- 40560  dark grey
gris oscuro
- 40561  matt nickel
níquel mate



4XGU 10 LED MAX 8W NOT INCL. [LED 14140]

METAL /
METAL

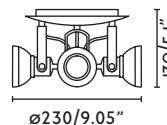
A++ to B / 100-240V ~ 50-60 Hz / 1.43 kg / 3.15 lb



wall lamp

- 40553  white
blanco
- 40554  dark grey
gris oscuro
- 40555  matt nickel
níquel mate

2XGU 10 LED MAX 8W NOT INCL. [LED 14140]

METAL /
METAL



A++ to B / 100-240V ~ 50-60 Hz / 0.95 kg / 2.09 lb

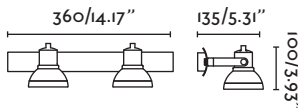

ONLY WITH LED / USO EXCLUSIVO LED



wall lamp

- 40556  white
blanco
- 40557  dark grey
gris oscuro
- 40558  matt nickel
níquel mate

3XGU 10 LED MAX 8W NOT INCL. [LED 14140]

METAL /
METAL

A++ to B / 100-240V ~ 50-60 Hz / 1.45 kg / 3.20 lb



ONLY WITH LED / USO EXCLUSIVO LED

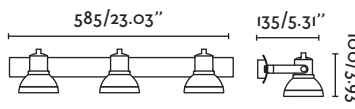



LED

yUri spotlight

OUT OF CATALOGUE
DESCATALOGADO

41103



chrome
cromo

HF

COB LED 5W 3000K 450LM INCL.
DRIVER INCL.

ALUMINIUM + METAL + TRANSLUCENT GLASS + TRANSPARENT GLASS /
ALUMINIO + METAL + CRISTAL TRANSLÚCIDO + CRISTAL TRANSPARENTE

A+ / 100-240V ~ 50-60 Hz / 0.6 kg / 1.32 lb

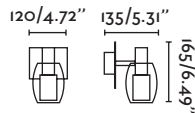

LED

yUri wall lamp

41104



chrome
cromo

HF

COB LED 10W 3000K 900LM INCL.
DRIVER INCL.

ALUMINIUM + METAL + TRANSLUCENT GLASS + TRANSPARENT GLASS /
ALUMINIO + METAL + CRISTAL TRANSLÚCIDO + CRISTAL TRANSPARENTE

A+ / 100-240V ~ 50-60 Hz / 1 kg / 2.20 lb

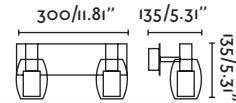

LED

yUri wall lamp

41105



chrome
cromo

HF

COB LED 15W 3000K 1350LM INCL.
DRIVER INCL.

ALUMINIUM + METAL + TRANSLUCENT GLASS + TRANSPARENT GLASS /
ALUMINIO + METAL + CRISTAL TRANSLÚCIDO + CRISTAL TRANSPARENTE

A+ / 100-240V ~ 50-60 Hz / 1.4 kg / 3.09 lb

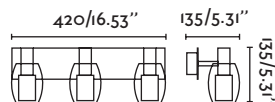

HF

Until stock exhaustion
Hasta final de stock
Jusqu'à la fin de stock

spotlights
focos
spots
faretti



SPOTLIGHTS

A spotlight can play a very precise role, such as lighting a picture (or artwork).

Un foco puede cumplir una función tan precisa como iluminar un cuadro.

Une ampoule peut remplir une fonction bien précise comme celle d'éclairer un tableau (ou une œuvre d'art).

LED

eRis spotlight

OUT OF CATALOGUE
DESCATALOGADO

41100



grey
gris

HF

COB LED 6W 3000K 500LM INCL.
DRIVER INCL.

METAL + ALUMINIUM + GLASS /
METAL + ALUMINIO + CRISTAL

A++ to A / 100-240V ~ 50-60 Hz / 0.5 kg / 1.10 lb

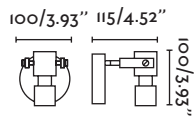

LED

eRis wall lamp

41101



grey
gris

HF

COB LED 12W 3000K 1000LM INCL.
DRIVER INCL.

METAL + ALUMINIUM + GLASS /
METAL + ALUMINIO + CRISTAL

A+ / 100-240V ~ 50-60 Hz / 1.1 kg / 2.43 lb

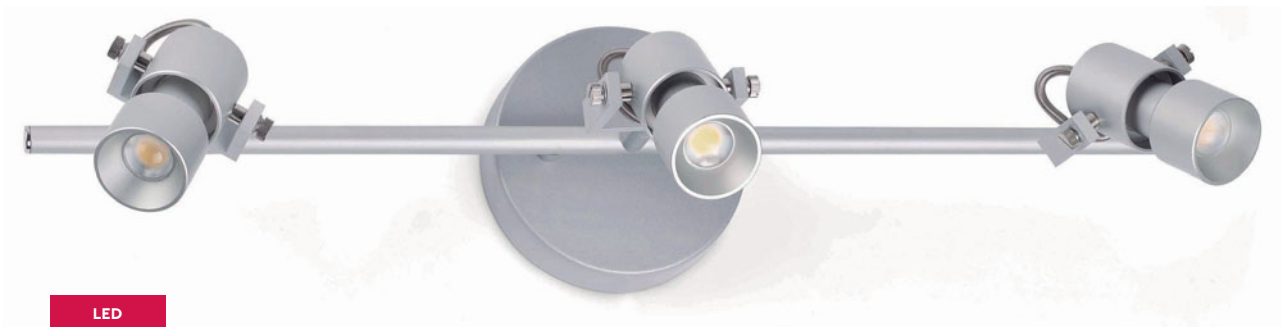
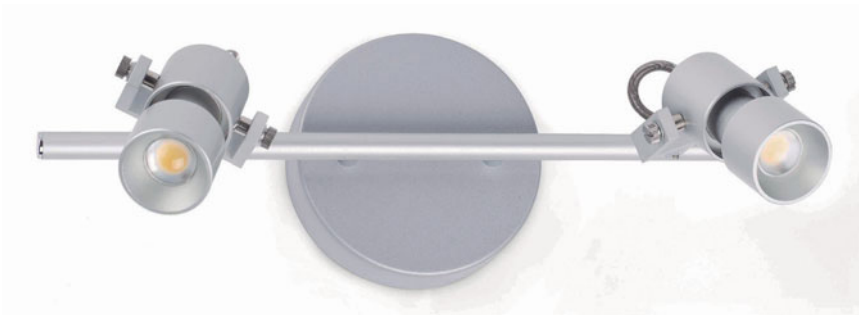
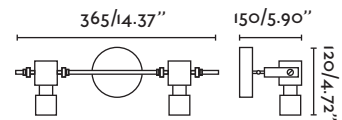

LED

eRis wall lamp

41102



grey
gris

HF

COB LED 18W 3000K 1500LM INCL.
DRIVER INCL.

METAL + ALUMINIUM + GLASS /
METAL + ALUMINIO + CRISTAL

A+ / 100-240V ~ 50-60 Hz / 1.5 kg / 3.31 lb

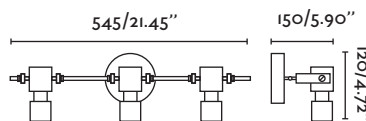

HF

Until stock exhaustion
Hasta final de stock
Jusqu'à la fin de stock

spotlights
focos
spots
faretti

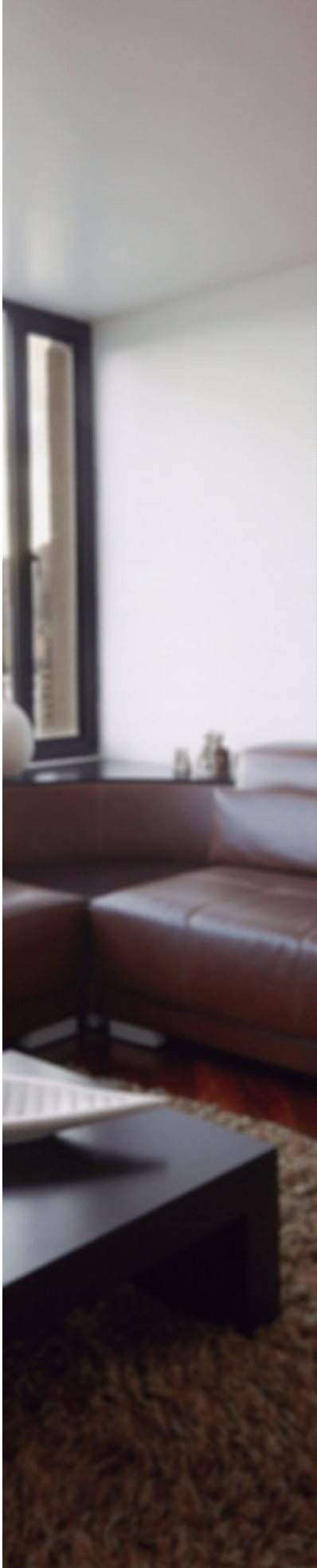

LED

boReal spotlight

40799



chrome
cromo

HF

COB LED 5W 3000K 450LM INCL.
DRIVER INCL.

METAL + GLASS /
METAL + CRISTAL

A++ / 100-240V ~ 50-60 Hz / 0.4 kg / 0.88 lb

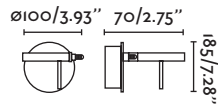

LED

boReal wall lamp

40800



chrome
cromo

HF

COB LED 10W 3000K 900LM INCL.
DRIVER INCL.

METAL + GLASS /
METAL + CRISTAL

A++ / 100-240V ~ 50-60 Hz / 0.9 kg / 1.98 lb

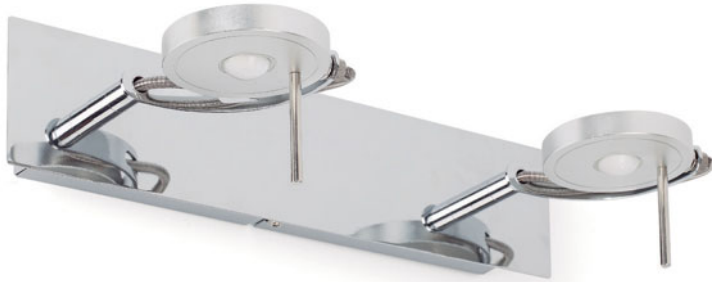
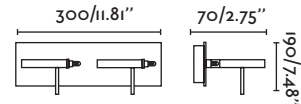

LED

boReal wall lamp

40805



chrome
cromo

HF

COB LED 15W 3000K 1350LM INCL.
DRIVER INCL.

METAL + GLASS /
METAL + CRISTAL

A++ / 100-240V ~ 50-60 Hz / 1.2 kg / 2.65 lb

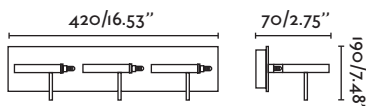

HF

Until stock exhaustion
Hasta final de stock
Jusqu'à la fin de stock

spotlights
focos
spots
faretti



BULB INCLUDED
BOMBILLA INCLUIDA

galAxia wall lamp

40792



matt nickel
níquel mate

2XGU10 MAX 50W INCL. [LED 14140]

METAL /
METAL

A++ to D / 220-240V ~ 50-60 Hz / 1.3 kg / 2.87 lb

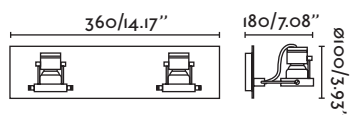



**BULB INCLUDED
BOMBILLA INCLUIDA**

galAxia spotlight

40791

● matt nickel
níquel mate

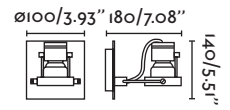

1 XGU 10 MAX 50W INCL. [LED I4140]

METAL /
METAL

A++ to D / 220-240V ~ 50-60 Hz / 0.6 kg / 1.32 lb

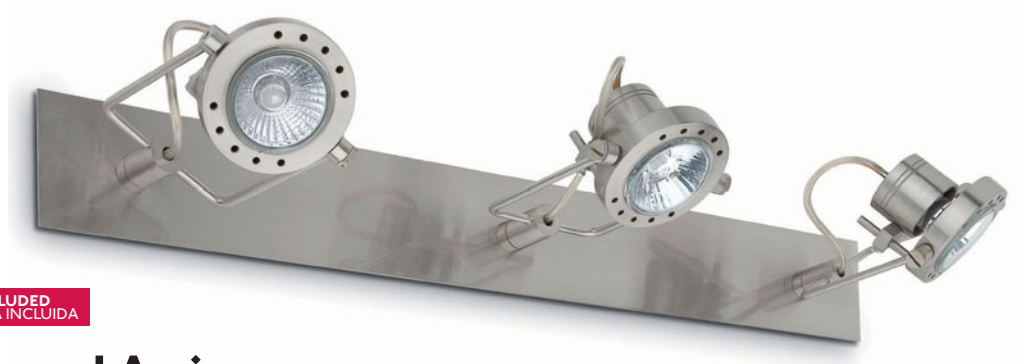

**BULB INCLUDED
BOMBILLA INCLUIDA**

galAxia wall lamp

40793

● matt nickel
níquel mate

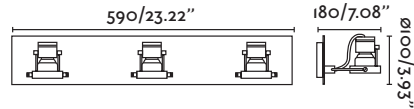

3 XGU 10 MAX 50W INCL. [LED I4140]

METAL /
METAL

A++ to D / 220-240V ~ 50-60 Hz / 2.1 kg / 4.63 lb



**BULB INCLUDED
BOMBILLA INCLUIDA**

galAxia wall lamp

40794

● matt nickel
níquel mate

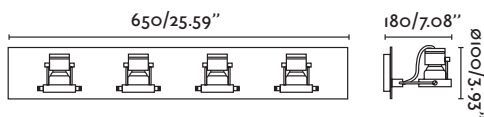

4 XGU 10 MAX 50W INCL. [LED I4140]

METAL /
METAL

A++ to D / 220-240V ~ 50-60 Hz / 2.49 kg / 5.49 lb





tubA spotlight

OUT OF CATALOGUE
DESCATALOGADO

40847



matt nickel
níquel mate

1 X GU10 MAX 11W NOT INCL. [LED 14140]

METAL + GLASS /
METAL + CRISTAL

A to E / 100-240V ~ 50-60 Hz / 0.4 kg / 0.88 lb

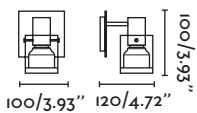



tubA wall lamp

40848

● matt nickel
níquel mate

OUT OF CATALOGUE
DESCATALOGADO

2XGU10 MAX IIW NOT INCL. [LED I4140]

METAL + GLASS /
METAL + CRISTAL

A to E / 100-240V ~ 50-60 Hz / 0.94 kg / 2.07 lb

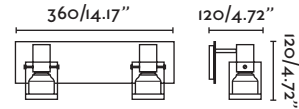

tubA wall lamp

40849

● matt nickel
níquel mate

3XGU10 MAX IIW NOT INCL. [LED I4140]

METAL + GLASS /
METAL + CRISTAL

A+++ to B / 100-240V ~ 50-60 Hz / 1.3 kg / 2.87 lb

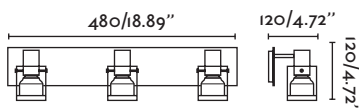



blAt spotlight

41010



chrome+white
cromo+blanco

1 XGU10 MAX II W NOT INCL. [LED 14140]

METAL + GLASS /
METAL + CRISTAL

A++ to E / 100-240V ~ 50-60 Hz / 0.3 kg / 0.66 lb

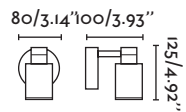

blAt wall lamp

41011



chrome+white
cromo+blanco

2 XGU10 MAX II W NOT INCL. [LED 14140]

METAL + GLASS /
METAL + CRISTAL

A++ to E / 100-240V ~ 50-60 Hz / 0.68 kg / 1.50 lb

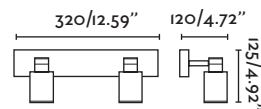

blAt wall lamp

41012



chrome+white
cromo+blanco

3 XGU10 MAX II W NOT INCL. [LED 14140]

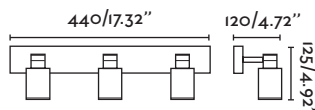

METAL + GLASS /
METAL + CRISTAL

A++ to E / 100-240V ~ 50-60 Hz / 0.97 kg / 2.14 lb





miKa wall lamp

- 40881  chrome+white
cromo+blanco
- 40885  chrome+black
cromo+negro

2XGU10 MAX 50W NOT INCL. [LED 14140]



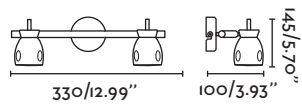

METAL /
METAL

A++ to E / 100-240V ~ 50-60 Hz / 0.59 kg / 1.30 lb





miKa spotlight

- 40880**   chrome+white
cromo+blanco
- 40884**   chrome+black
cromo+negro

1XGU10 MAX 50W NOT INCL. [LED 14140]

METAL /
METAL





A++ to E / 100-240V ~ 50-60 Hz / 0.27 kg / 0.60 lb

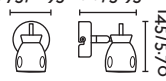

ø75/2.95" 100/3.93"



miKa ceiling lamp

- 40883**   chrome+white
cromo+blanco
- 40887**   chrome+black
cromo+negro



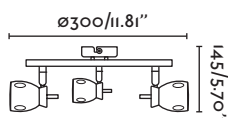

3XGU10 MAX 50W NOT INCL. [LED 14140]

METAL /
METAL

A++ to E / 100-240V ~ 50-60 Hz / 1.12 kg / 2.47 lb



miKa wall lamp

- 40882**   chrome+white
cromo+blanco
- 40886**   chrome+black
cromo+negro

3XGU10 MAX 50W NOT INCL. [LED 14140]

METAL /
METAL

A++ to E / 100-240V ~ 50-60 Hz / 0.81 kg / 1.79 lb

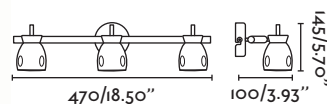



BULB INCLUDED
BOMBILLA INCLUIDA



álAmo spotlight

40938



wenge+chrome
wengué+cromo

1 X G9 40W INCL. [LED 17440]

WOOD + METAL + TRANSLUCENT GLASS /
MADERA + METAL + CRISTAL TRANSLÚCIDO

A to D / 220-240V ~ 50-60 Hz / 0.82 kg / 1.81 lb

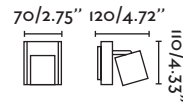

BULB INCLUDED
BOMBILLA INCLUIDA

álAmo wall lamp

40939



wenge+chrome
wengué+cromo

2 X G9 40W INCL. [LED 17440]

WOOD + METAL + TRANSLUCENT GLASS /
MADERA + METAL + CRISTAL TRANSLÚCIDO

A to D / 220-240V ~ 50-60 Hz / 1.8 kg / 3.97 lb

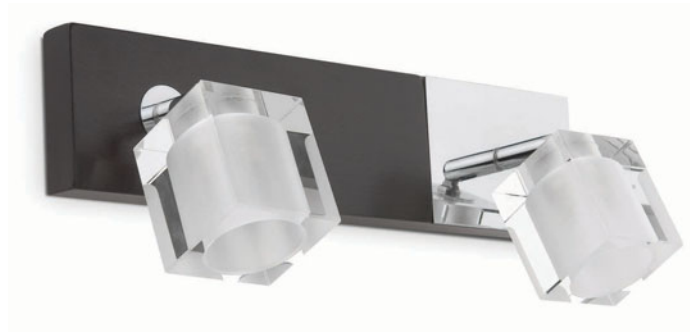
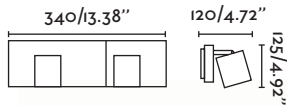

BULB INCLUDED
BOMBILLA INCLUIDA

álAmo wall lamp

40940



wenge+chrome
wengué+cromo

3 X G9 40W INCL. [LED 17440]

WOOD + METAL + TRANSLUCENT GLASS /
MADERA + METAL + CRISTAL TRANSLÚCIDO

A to D / 220-240V ~ 50-60 Hz / 2.77 kg / 6.11 lb

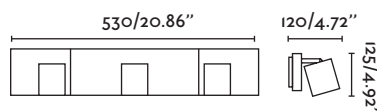





**BULB INCLUDED
BOMBILLA INCLUIDA**

álAmo pendant lamp

40941



wenge+chrome
wengué+cromo

4XG9 40W INCL. [LED 17440]

WOOD + METAL + TRANSLUCENT GLASS /
MADERA + METAL + CRISTAL TRANSLÚCIDO

A to D / 220-240V ~ 50-60 Hz / 4.1 kg / 9.04 lb

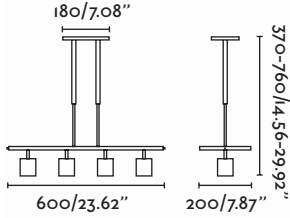

**BULB INCLUDED
BOMBILLA INCLUIDA**

álAmo pendant lamp

40942



wenge+chrome
wengué+cromo

5XG9 40W INCL. [LED 17440]

WOOD + METAL + TRANSLUCENT GLASS /
MADERA + METAL + CRISTAL TRANSLÚCIDO

A to D / 220-240V ~ 50-60 Hz / 5 kg / 11.02 lb

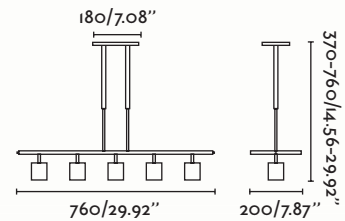



BULB INCLUDED
BOMBILLA INCLUIDA

dRaco wall lamp

40907



wenge+chrome
wengué+cromo

2XG9 40W INCL. [LED 17440]

METAL + TRANSLUCENT GLASS /
METAL + CRISTAL TRANSLÚCIDO

A to D / 220-240V ~ 50-60 Hz / 0.79 kg / 1.74 lb

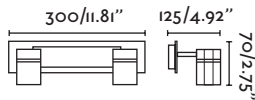

HF



BULB INCLUDED
BOMBILLA INCLUIDA

dRaco wall lamp

40908



wenge+chrome
wengué+cromo

OUT OF CATALOGUE
DESCATALOGADO

3XG9 40W INCL. [LED 17440]

METAL + TRANSLUCENT GLASS /
METAL + CRISTAL TRANSLÚCIDO

A to D / 220-240V ~ 50-60 Hz / 1.13 kg / 2.49 lb

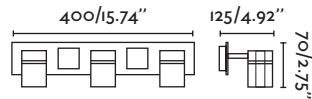

BULB INCLUDED
BOMBILLA INCLUIDA

dRaco ceiling lamp

40909



wenge+chrome
wengué+cromo

4XG9 40W INCL. [LED 17440]

METAL + TRANSLUCENT GLASS /
METAL + CRISTAL TRANSLÚCIDO

A to D / 220-240V ~ 50-60 Hz / 1.58 kg / 3.48 lb

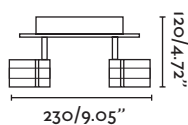

HF



HF

Until stock exhaustion
Hasta final de stock
Jusqu'à la fin de stock

spotlights
focos
spots
faretti





BULB INCLUDED
BOMBILLA INCLUIDA

sTar spotlight

40871



wood+rust brown
madera+marrón óxido

1XGU10 MAX 50W INCL.

METAL + WOOD /
METAL + MADERA

A to D / 220-240V ~ 50-60 Hz / 0.36 kg / 0.79 lb

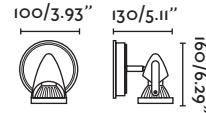

BULB INCLUDED
BOMBILLA INCLUIDA

sTar wall lamp

40872



wood+rust brown
madera+marrón óxido

2XGU10 MAX 50W INCL.

METAL + WOOD /
METAL + MADERA

A to D / 220-240V ~ 50-60 Hz / 0.77 kg / 1.70 lb

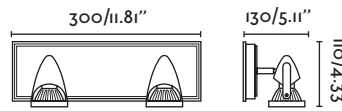

BULB INCLUDED
BOMBILLA INCLUIDA

sTar wall lamp

40873



wood+rust brown
madera+marrón óxido

3XGU10 MAX 50W INCL.

METAL + WOOD /
METAL + MADERA

A to D / 220-240V ~ 50-60 Hz / 1.1 kg / 2.43 lb

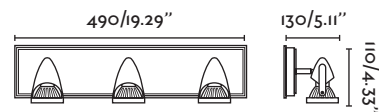



BULB INCLUDED
BOMBILLA INCLUIDA

sTar wall lamp

40892



rust brown
marrón óxido

2XGU10 MAX 50W INCL.

METAL /
METAL

A to D / 220-240V ~ 50-60 Hz / 0.7 kg / 1.54 lb

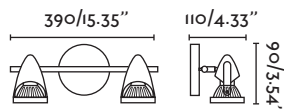

BULB INCLUDED
BOMBILLA INCLUIDA



sTar spotlight

4039I  matt nickel
níquel mate

404II  old gold
oro envejecido

4089I  rust brown
marrón óxido

1 XGU 10 MAX 50W INCL.

METAL /
METAL

A to D / 220-240V ~ 50-60 Hz / 0.3 kg / 0.66 lb

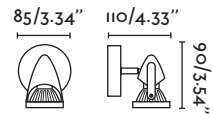

BULB INCLUDED
BOMBILLA INCLUIDA

sTar ceiling lamp

40396  matt nickel
níquel mate

2XGU 10 MAX 50W INCL.

METAL /
METAL

A to D / 220-240V ~ 50-60 Hz / 0.7 kg / 1.54 lb

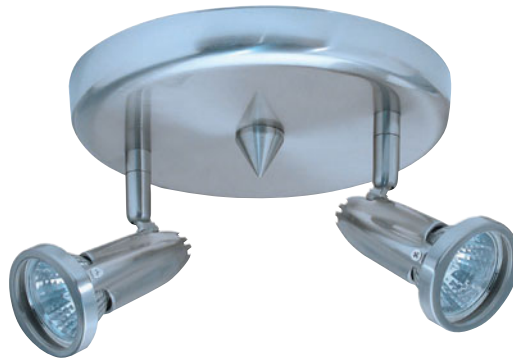
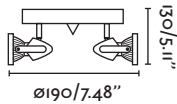

BULB INCLUDED
BOMBILLA INCLUIDA

sTar ceiling lamp

40397  matt nickel
níquel mate

3XGU 10 MAX 50W INCL.

METAL /
METAL

A to D / 220-240V ~ 50-60 Hz / 1 kg / 2.20 lb

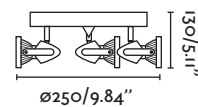

BULB INCLUDED
BOMBILLA INCLUIDA



sTar ceiling lamp

40395

 matt nickel
níquel mate

3XGU10 MAX 50W INCL.

METAL /
METAL

A to D / 220-240V ~ 50-60 Hz / 1.1 kg / 2.43 lb

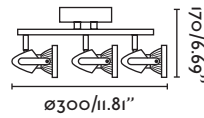

BULB INCLUDED
BOMBILLA INCLUIDA

sTar ceiling lamp

40393

 matt nickel
níquel mate

40893

 rust brown
marrón óxido

3XGU10 MAX 50W INCL.

METAL /
METAL

A to D / 220-240V ~ 50-60 Hz / 0.99 kg / 2.18 lb

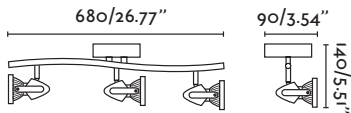

BULB INCLUDED
BOMBILLA INCLUIDA

sTar ceiling lamp

40394

 matt nickel
níquel mate

4XGU10 MAX 50W INCL.

METAL /
METAL

A to D / 220-240V ~ 50-60 Hz / 1.22 kg / 2.69 lb

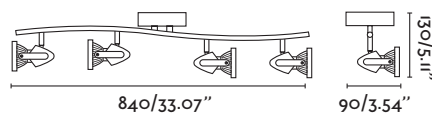

tuRbo spotlight



40271  white
blanco

1XR63 E27 MAX 60W NOT INCL. [I5601] [LED I7431]

METAL /
METAL

A++ to E / 100-240V ~ 50-60 Hz / 0.4 kg / 0.88 lb

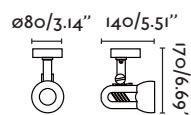

tuRbo wall lamp

40272  white
blanco

2XR63 E27 MAX 60W NOT INCL. [I5601] [LED I7431]

METAL /
METAL

A++ to E / 100-240V ~ 50-60 Hz / 0.8 kg / 1.76 lb

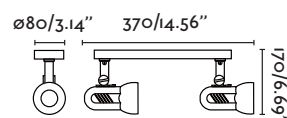

tuRbo wall lamp

40273  white
blanco

3XR63 E27 MAX 60W NOT INCL. [I5601] [LED I7453]

METAL /
METAL

A++ to E / 100-240V ~ 50-60 Hz / 1.1 kg / 2.43 lb

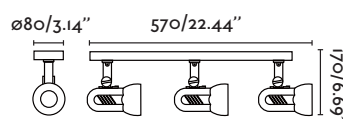

BULB INCLUDED
BOMBILLA INCLUIDA

luNe spotlight

40421

● matt nickel
níquel mate

1 XGU10 MAX 50W INCL.

METAL /
METAL

A to D / 220-240V ~ 50-60 Hz / 0.3 kg / 0.66 lb

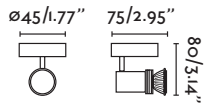

BULB INCLUDED
BOMBILLA INCLUIDA

luNe wall lamp

40422

● matt nickel
níquel mate

2 XGU10 MAX 50W INCL.

METAL /
METAL

A to D / 220-240V ~ 50-60 Hz / 0.7 kg / 1.54 lb

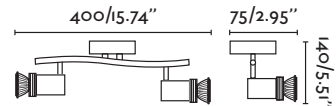

BULB INCLUDED
BOMBILLA INCLUIDA

luNe wall lamp

40423

● matt nickel
níquel mate

3 XGU10 MAX 50W INCL.

METAL /
METAL

A to D / 220-240V ~ 50-60 Hz / 0.98 kg / 2.16 lb

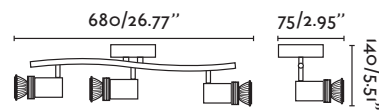



BULB INCLUDED
BOMBILLA INCLUIDA

luNe ceiling lamp

40426

● matt nickel
níquel mate

2XGU10 MAX 50W INCL.

METAL /
METAL

A to D / 220-240V ~ 50-60 Hz / 0.46 kg / 1.01 lb

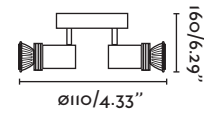

BULB INCLUDED
BOMBILLA INCLUIDA

luNe ceiling lamp

40425

● matt nickel
níquel mate

3XGU10 MAX 50W INCL.

METAL /
METAL

A to D / 220-240V ~ 50-60 Hz / 1.16 kg / 2.56 lb

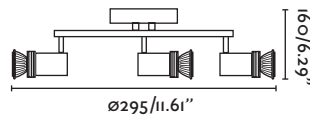

BULB INCLUDED
BOMBILLA INCLUIDA

luNe ceiling lamp

40427

● matt nickel
níquel mate

3XGU10 MAX 50W INCL.

METAL /
METAL

A to D / 220-240V ~ 50-60 Hz / 0.62 kg / 1.37 lb

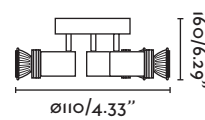

track projectors

proyectors de carril/projecteurs sur rail/faretto per binario

 **nAn** [new] 205

 **pLot** [new] 206

 **rAm** [new] 207

 **riNg** [new] 205





TRACK

PROJECTORS



track projectors
projectores de carril
projecteurs sur rail
fareto per binario







[new] riNg
track projector

- 40562  white
blanco
- 40563  dark grey
gris oscuro
- 40564  matt nickel
níquel mate

1 XGU10 MAX 8W NOT INCL. [LED I7310]

METAL /
METAL

A++ to B / 100-240V ~ 50-60 Hz / 0.29 kg / 0.64 lb

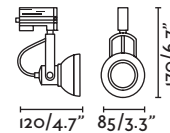

[new] nAn
track projector

- 64192  white
blanco

1 XGU10 MAX 50W NOT INCL. [LED I7310]

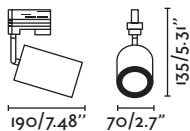

ALUMINIUM /
ALUMINIO

A++ to E / 100-240V ~ 50-60 Hz / 0.4 kg / 0.88 lb





[new] pLot
track projector

- 64202  white
blanco
- 64203  black
negro

1 XGU10 50W NOT INCL. [LED 17310]

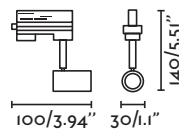

METAL /
 METAL

A++ to E / 100-240V ~ 50-60 Hz / 0.14 kg / 0.31 lb





[new] rAm
track projector

- 40100**  white
blanco
- 40101**  black
negro

1 X E27 PAR30 MAX 80W NOT INCL. [LED 17401]

DIE CAST ALUMINIUM /
ALUMINIO INYECTADO

A+++ to E / 100-240V ~ 50-60 Hz / 0.3 kg / 0.66 lb

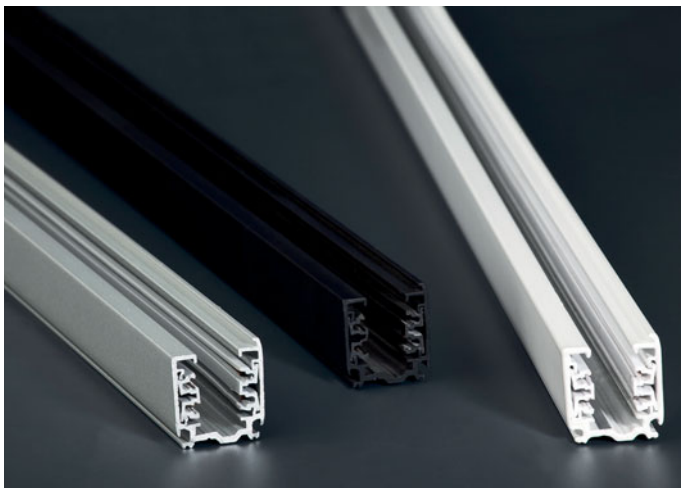
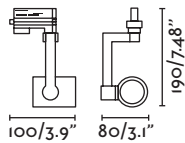



SURFACE TRACK KIT 1M /
KIT CARRIL SUPERFICIE 1M

- 64210**  white
blanco
- 64212**  black
negro
- 64214**  grey
gris























SURFACE TRACK KIT 2M /
KIT CARRIL SUPERFICIE 2M

- 64211**  white
blanco
- 64213**  black
negro
- 64215**  grey
gris

- Main supply 
Cabezal de alimentación
- End cap without power 
Cabezal de cierre
- Surface ceiling kit 
Soporte de

wall fixtures

apliques/appliques/lampade da parete

 Ally	219	 geNaker	242	 oVo <i>[new]</i>	226
 aMbo	232	 giNa	231	 pEtra	219
 áNgulo	243	 grOe	235	 porTos	245
 auRea <i>[new]</i>	215	 heNlein	251	 raY	225
 biRd	228	 hEnri	217	 roDa	217
 bugAtti	224	 homS	231	 rOom <i>[new]</i>	210
 ceLia	219	 ibiScus	243	 saBana	212
 chEras	238	 kaPa	221	 sAmi <i>[new]</i>	221
 cOde	229	 kLimt	249	 siNki	217
 conO	241	 liRia	244	 siNtra	245
 dAllas <i>[new]</i>	231	 loKe	223	 sNow <i>[new]</i>	235
 dAta	246	 luMiere	251	 sunNy	247
 dEgas	249	 mOnet	251	 swiNg <i>[new]</i>	214
 diuLa	246	 neRis	225	 tuB	221
 eAco	237	 Ola	247	 Twin	240
 eQui	246	 osLo <i>[new]</i>	235	 veRa	243



WAL

FIXTURES



rOom [new]

by Manel Llusçà

Elegant and timeless design. The same wall light with renewed lines. Version with LED reader for added comfort in bedrooms or living rooms.

Diseño elegante y atemporal. El aplique de siempre con líneas renovadas. Versión con lector de LED para un mayor confort en dormitorios o salas de estar.

Design élégant et intemporel. Applique avec des lignes renouvelées. Version avec lecteur LED pour plus de confort dans les chambres ou salles de séjour.





[new] wall lamp

- 29974   matt nickel+white
níquel mate+blanco
- 29975   matt nickel+black
níquel mate+negro



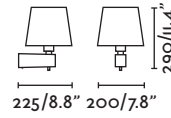

1XE27 20W NOT INCL. [16177] [LED 17453]

METAL + TEXTILE /
METAL + TÉXTIL

A++ to E / 100-240V ~ 50-60 Hz / 0.84 kg / 1.85 lb



[new] wall lamp+reader

- 29976   matt nickel+white
níquel mate+blanco
- 29977   matt nickel+black
níquel mate+negro

1XE27 20W NOT INCL. [16177] [LED 17453]
+ LED 3W 3000K INCL.

METAL + TEXTILE /
METAL + TÉXTIL

A++ to E / 100-240V ~ 50-60 Hz / 0.91 kg / 2.01 lb

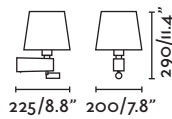

saBana

by Pepe Llaudet

Based on true african lodge style, the metal arm is characterized by the angular delivery of a vertical line and a horizontal functional support.

Ambientada al más puro estilo lodge africano, su brazo metálico se caracteriza por la angular entrega de una línea vertical a otra horizontal y por su funcional soporte.

Située dans le style lodge africain le plus pur, son bras métallique se caractérise par une distribution angulaire d'une ligne verticale à une autre horizontale et par son support fonctionnel.

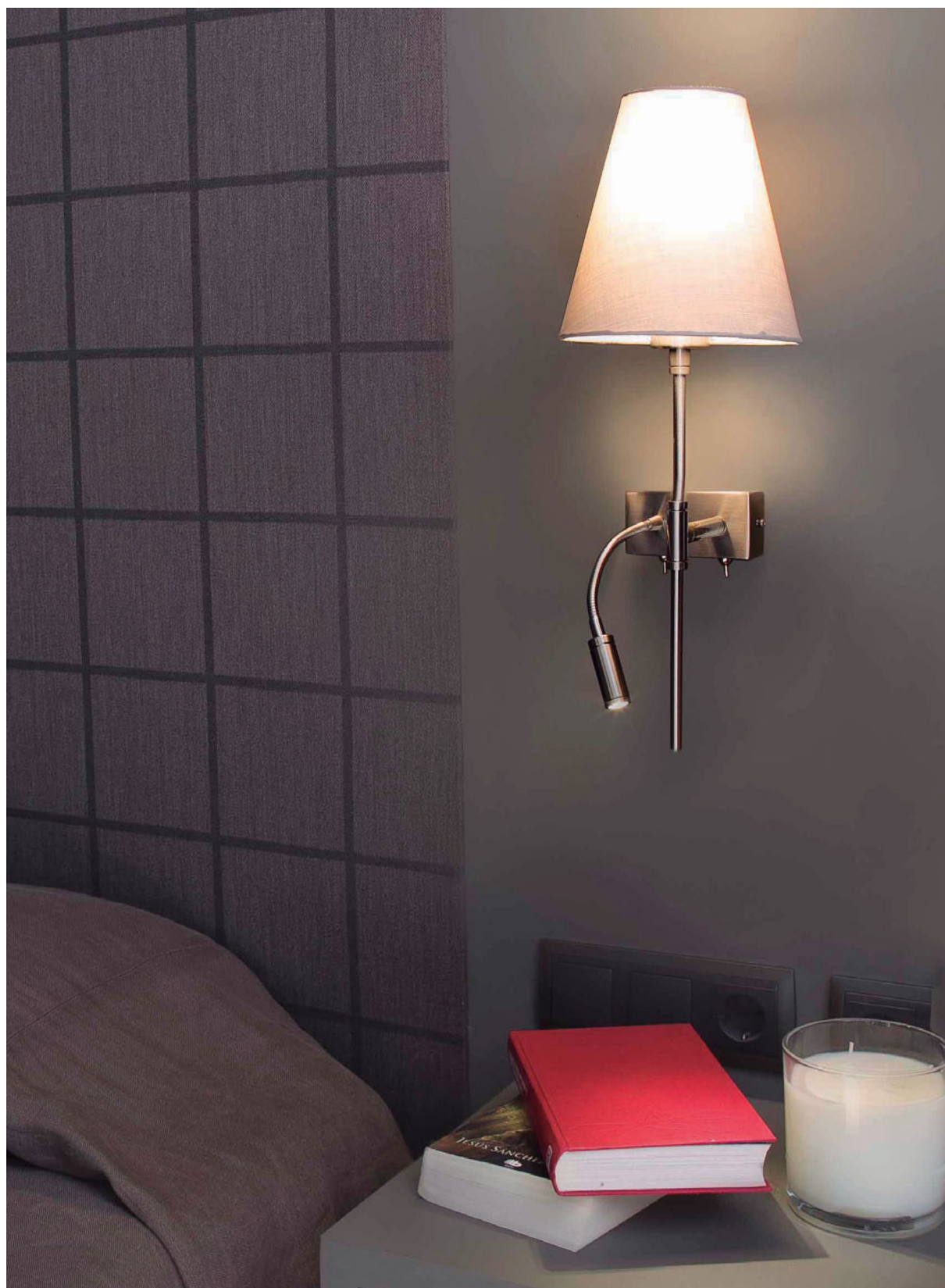



wall lamp

29993



matt nickel+beige
níquel mate+beige

1 XE27 MAX 15W NOT INCL. [16177] [LED 17453]

STEEL + TEXTILE /
ACERO + TÉXTIL

A++ to B / 100-240V ~ 50-60 Hz / 1.25 kg / 2.76 lb

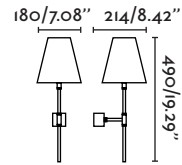

wall lamp+reader

29991



matt nickel+beige
níquel mate+beige

29992



matt nickel+beige
níquel mate+beige

1 XE27 MAX 15W NOT INCL. [16177] [LED 17453]
HIGH POWER LED 1 W 4000K INCL.
DRIVER INCL.

STEEL + TEXTILE /
ACERO + TÉXTIL

A++ to B / 100-240V ~ 50-60 Hz / 0.67 kg / 1.48 lb

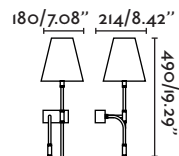

REF. 29992



REF. 29991

swiNg [new]

by Manel Llusçà

Versatile and practical surface luminaire. It has a double functionality: wall light and bed reader. Its rounded and clean lines, that hide its mechanical part, stand out.

Luminaria de superficie versátil y práctica. Presenta una doble funcionalidad: aplique y lector de cama. Destacan sus líneas redondeadas y limpias que ocultan su parte más mecánica.

Luminaire de surface polyvalente et pratique. Présente une double fonction: applique et lecteur de lit. Ses lignes arrondies et épurées cachent sa partie mécanique.



ORIENTABLE LED

[new] wall lamp

62112  chrome
cromo

62113  white
blanco

COB LED 6W 3000K 160LM CRI>80 INCL.
DRIVER INCL.

METAL /
METAL

A++ to A / 100-240V ~ 50-60 Hz / 0.62 kg / 1.37 lb

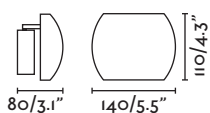

auRea [new]

by Estudi Ribaudí

Aurea is an analysis of the light, a shadow game that creates shades and gradients that give us new sensations. It is simplicity of the shapes, a timeless design.

Aurea es un análisis sobre la luz, un juego de sombras que crea matices y degradados que nos transmiten nuevas sensaciones. Es simplicidad de las formas, un diseño atemporal.

Aurea est une analyse de la lumière, un jeu d'ombre qui crée des nuances et des dégradés qui nous donnent de nouvelles sensations. C'est la simplicité des formes, design intemporel.



ORIENTABLE WITH SWITCH CON INTERRUPTOR LED

[new] wall lamp

62115

white
blanco

SMD LED 6W 2700K 230LM CRI>80 INCL.
DRIVER INCL.

STEEL + ALUMINIUM + TRANSLUCENT POLYCARBONATE /
ACERO + ALUMINIO + POLICARBONATO TRANSLÚCIDO

A / 100-240V ~ 50-60 Hz / 0.34 kg / 0.75 lb

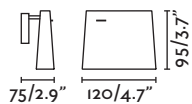

wall fixtures
apliques
appliques
lampade de parete





siNki wall lamp+reader

63187  chrome
cromo

1 X E27 MAX 60W NOT INCL. [16292] [LED 17453]
HIGH POWER LED 1 W 4000K 100LM INCL.
DRIVER INCL.

METAL + TEXTILE /
METAL + TÉXIL

A++ to D / 100-240V ~ 50-60 Hz / 1.7 kg / 3.75 lb

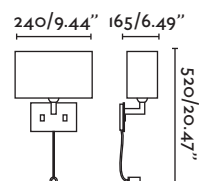

roDa wall lamp

62988  matt nickel
níquel mate

1 X E27 MAX 60W NOT INCL. [16292] [LED 17453]

STEEL + TEXTILE /
ACERO + TÉXIL

A++ to E / 100-240V ~ 50-60 Hz / 0.9 kg / 1.98 lb

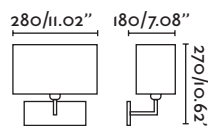

hEnri wall lamp

63191  chrome
cromo

1 X E27 MAX 60W NOT INCL. [16467] [LED 17453]

METAL + TEXTILE /
METAL + TÉXIL

A++ to B / 100-240V ~ 50-60 Hz / 0.61 kg / 1.34 lb

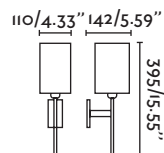



WALL LAMPS

An extensible or articulated wall lamp can be very useful for illuminating your reading.

Un aplique articulado o extensible puede ser muy útil a la hora de iluminar tus lecturas.

Une applique articulée ou extensible peut être très utile à l'heure d'éclairer vos lectures. D'éclairer un tableau (ou une œuvre d'art).



EXTENSIBLE

pEtra wall lamp

40062

chrome
cromo

1 XE 14 MAX 40W NOT INCL. [16290] [LED 17452]
METAL / METAL
A++ to E / 100-240V ~ 50-60 Hz / 0.83 kg / 1.83 lb

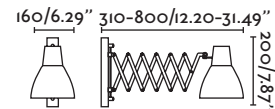

ORIENTABLE

Ally wall lamp

OUT OF CATALOGUE
DESCATALOGADO

28400

matt nickel
níquel mate

HF

1 XGU 10 MAX 35W NOT INCL. [14029] [LED 14140]
ALUMINIUM + WOOD /
ALUMINIO + MADERA
A++ to E / 100-240V ~ 50-60 Hz / 0.6 kg / 1.32 lb

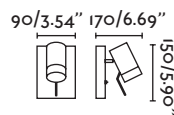

HF Until stock exhaustion
Hasta final de stock
Jusqu'à la fin de stock



WITH PLUG
CON ENCHUFE

ceLiA wall lamp

40070

black
negro

1 XE 14 MAX 20W NOT INCL. [16239] [LED 17451]
METAL + STEEL /
METAL + ACERO

A++ to B / 100-240V ~ 50-60 Hz / 0.73 kg / 1.61 lb

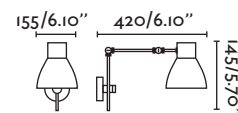

wall fixtures
apliques
appliques
lampare de parete





LED

[new] sAmi
wall lamp

41023  white
blanco

HIGH POWER LED. 3W 2700K 120LM CRI>80 INCL.
DRIVER INCL.

METAL /
METAL

A+ / 100-240V ~ 50-60 Hz / 0.4 kg / 0.88 lb

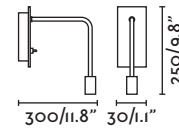

LED

kaPa
wall lamp

40933  matt nickel
níquel mate

HIGH POWER LED 1W 6500K 60LM INCL.
DRIVER INCL.

ALUMINIUM + METAL /
ALUMINIO + METAL

A++ / 100-240V ~ 50-60 Hz / 0.6 kg / 1.32 lb

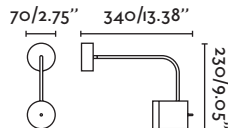

LED

tuB
wall lamp

63231  silver
plata

63232  matt white
blanco mate

HIGH POWER LED 3W 3000K 140LM INCL.
DRIVER INCL.

ALUMINIUM + OPTICAL GLASS K9 /
ALUMINIO + CRISTAL ÓPTICO K9

A++ / 220-240V ~ 50-60 Hz / 0.5 kg / 1.10 lb

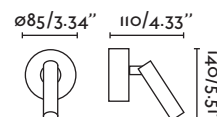





LED

loKe wall lamp

40994  chrome
cromo

[new] 41019  white
blanco

[new] 41020  black
negro

HIGH POWER LED 3W 3000K 150LM CRI>80 INCL.
DRIVER INCL.

ALUMINIUM + METAL /
ALUMINIO + METAL

A++ / 100-240V ~ 50-60 Hz / 0.6 kg / 1.32 lb

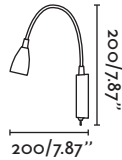

LED

loKe clip

40995  chrome
cromo

[new] 41021  white
blanco

[new] 41022  black
negro

HIGH POWER LED 3W 3000K 120LM CRI>80 INCL.
DRIVER INCL.

ALUMINIUM + METAL /
ALUMINIO + METAL

A++ / 100-240V ~ 50-60 Hz / 0.6 kg / 1.32 lb

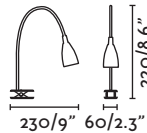

LED

loKe recessed

40996  chrome
cromo

HIGH POWER LED 3W 3000K 150 LM INCL.
DRIVER INCL.

ALUMINIUM + METAL /
ALUMINIO + METAL

A++ / 100-240V ~ 50-60Hz / 0.27 kg / 0.60 lb

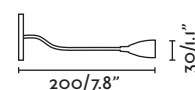



BULB INCLUDED
BOMBILLA INCLUIDA

bugAtti wall lamp

40917



matt nickel
níquel mate

1 X GU 10 MAX 50W INCL.

METAL + ALUMINIUM /
METAL + ALUMINIO

A to D / 220-240V ~ 50-60 Hz / 0.54 kg / 1.19 lb

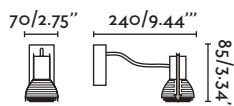



LED

neRis wall lamp

40937



chrome
cromo

HIGH POWER LED 3W 5500K 130LM INCL.
DRIVER INCL.

ALUMINIUM + METAL /
ALUMINIO + METAL

A++ / 220-240V ~ 50-60 Hz / 0.7 kg / 1.54 lb

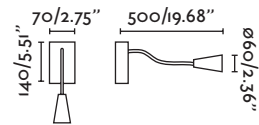

LED

raY wall lamp

61046



old gold
oro envejecido

61047



matt nickel
níquel mate

SMD LED 6W 3000K 600LM INCL.
DRIVER INCL.

ALUMINIUM + POLYCARBONATE /
ALUMINIO + POLICARBONATO

A++ / 220-240V ~ 50-60 Hz / 0.8 kg / 1.76 lb



HF

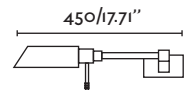

HF

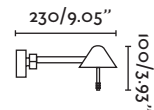

HF

Until stock exhaustion
Hasta final de stock
Jusqu'à la fin de stock

oVo [new]

by Estudi Ribaudí

Ovo provides us with a design that is fully integrated into the spaces, lights them up; it offers us different shapes, obtaining effects and games that enrich them.

Ovo nos proporciona un diseño que se integra plenamente en los espacios, los ilumina; nos ofrece diferentes formas, consiguiendo efectos y juegos que los enriquecen.

Ovo nous fournit un design qui est pleinement intégré dans les espaces, il les illumine; il nous offre différentes formes, en obtenant des effets et des jeux qui les enrichissent.



WALL WASHERS



Wall lights emit a diffuse light and enhance spaces.

Los apliques bañadores de pared emiten una luz difusa y realzan espacios.

Les appliques qui baignent les murs émettent une lumière diffuse et mettent en avant les espaces.

ORIENTABLE

[new] **wall lamp-p**

- 62105  white
blanco
- 62106  beige
beige
- 62107  olive green
verde oliva

1 XR7S 78MM MAX 75W NOT INCL. [I2030]

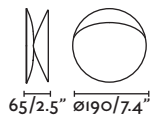

METAL /
METAL

A++ to E / 100-240V ~ 50-60 Hz / 0.7 kg / 1.54 lb



ORIENTABLE

[new] **wall lamp-g**

- 62108  white
blanco
- 62109  beige
beige
- 62110  olive green
verde oliva

1 XR7S 117MM MAX 100W NOT INCL. [I2032]

METAL + POLYCARBONATE /
METAL + POLICARBONATO

A++ to E / 100-240V ~ 50-60 Hz / 1.12 kg / 2.47 lb

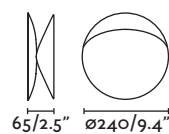

biRd

by Estudi Ribaudí

Bird is a wall lamp inspired by Japanese origami, a culture that sought permanent harmony in open spaces.

Bird es un aplique inspirado en la papiroflexia japonesa, una cultura que buscaba la permanente armonía en sus espacios abiertos.

Bird est une applique inspirée de l'origami japonais, une culture à la recherche d'une harmonie permanente dans ses espaces ouverts.



wall lamp

75509

white
blanco

75510

grey
gris

75511

black
negro

1 X E27 MAX 20W NOT INCL. [16466] [LED 17453]

DIE CAST ALUMINIUM + TRANSLUCENT POLYCARBONATE /
ALUMINIO INYECTADO + POLICARBONATO TRANSLÚCIDO

A++ to B / 100-240V ~ 50-60 Hz / 0.7 kg / 1.54 lb

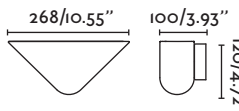

cOde

by Estudi Ribaudí

Code is an eclipse of light,
a path of concentric circles
that accompany us almost
unnoticed.

Code es un eclipse de luz, un
camino de círculos concéntricos
que nos acompañan de una
forma casi imperceptible.

Code est une éclipse de
lumière, un chemin de cercles
concentriques qui nous accom-
pagnent de manière presque
imperceptible.



LED

wall lamp

71526

white
blanco

71527

dark grey
gris oscuro

SMD LED 0,2W 4000K 150LM INCL.
DRIVER INCL.
3 STICKERS INCL.



POLYCARBONATE /
POLICARBONATO

A++ to A / 220-240V ~ 50-60 Hz / 0.2 kg / 0.44 lb

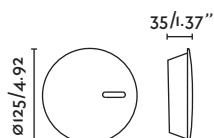
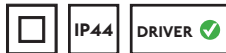

wall fixtures
apliques
appliques
lampade de parete

229



LED

[new] dallas wall lamp

63199

○ white
blanco

COB LED 5W 3000K 435LM INCL.
DRIVER INCL.

ALUMINIUM /
ALUMINIO

A++ to A / 100-240V ~ 50-60 Hz / 0.37 kg / 0.82 lb

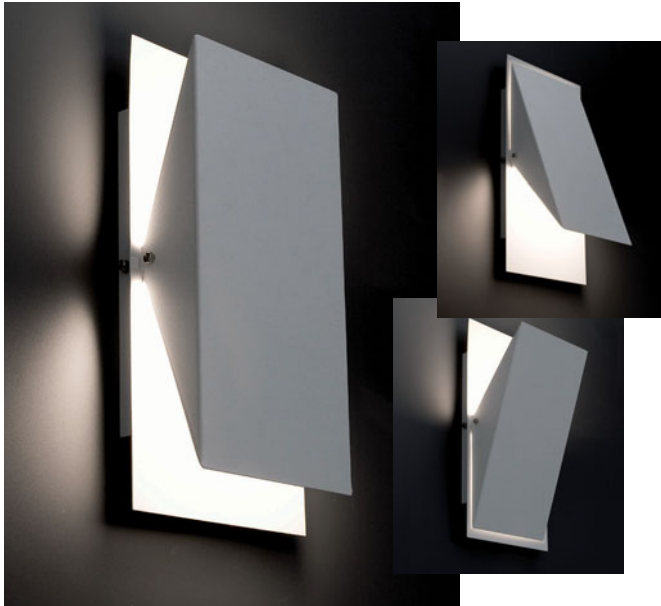
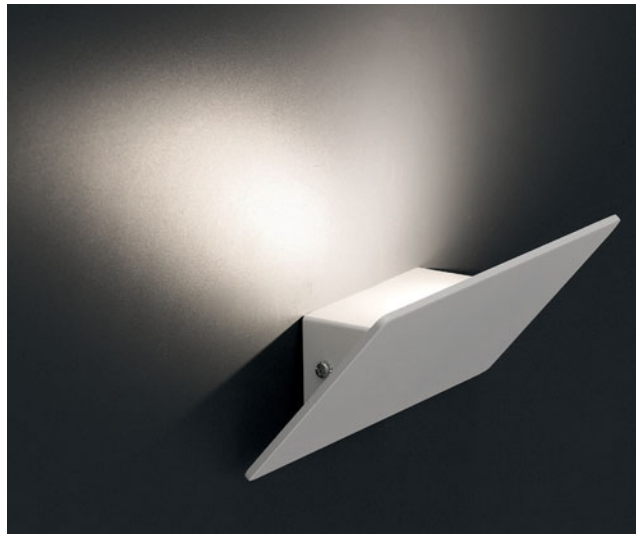
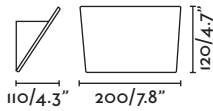

ORIENTABLE

BULB INCLUDED
BOMBILLA INCLUIDA

homS wall lamp

63167

○ white
blanco

1XR7S JP78 MAX 100W INCL.

METAL /
METAL

A to D / 220-240V ~ 50-60 Hz / 1.93 kg / 4.25 lb

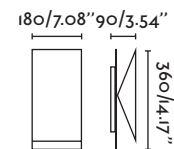

IP44

giNa wall lamp

71366

○ white
blanco

71367

● black
negro

[new] 71363

● dark grey
gris oscuro

1XGU10 MAX 35W NOT INCL. [LED 14141]

DIE CAST ALUMINIUM + GLASS /
ALUMINIO INYECTADO + CRISTAL

A++ to E / 100-240V ~ 50-60 Hz / 0.44 kg / 0.97 lb

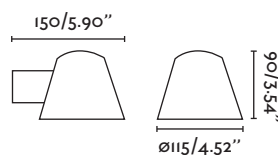

wall fixtures
apliques
appliques
lampade da parete



UP & DOWN
ARRIBA Y ABAJO

aMbo wall lamp

63200



polished aluminium
aluminio pulido

1 X2G II MAX 36W NOT INCL. [I5923]
GEAR INCL.

ALUMINIUM + TRANSLUCENT GLASS /
ALUMINIO + CRISTAL TRANSLÚCIDO

A++ to E / 220-240V ~ 50-60 Hz / 1.93 kg / 4.25 lb



BALLAST 



120/4.72"

480/18.89"

60/2.36"





UP & DOWN
ARRIBA Y ABAJO

aMbo wall lamp

63186

polished aluminium
aluminio pulido

1XE27 MAX 15W NOT INCL. [16166] [LED 17452]

ALUMINIUM + TRANSLUCENT GLASS /
ALUMINIO + CRISTAL TRANSLÚCIDO

A++ to B / 220-240V ~ 50-60 Hz / 1 kg / 2.20 lb

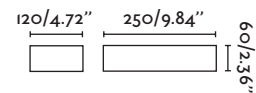

UP & DOWN
ARRIBA Y ABAJO

aMbo wall lamp

63202

polished aluminium
aluminio pulido

2XR7S JP I18 MAX 100W NOT INCL. [12032]

ALUMINIUM + TRANSLUCENT GLASS /
ALUMINIO + CRISTAL TRANSLÚCIDO

A++ to E / 220-240V ~ 50-60 Hz / 1.47 kg / 3.24 lb

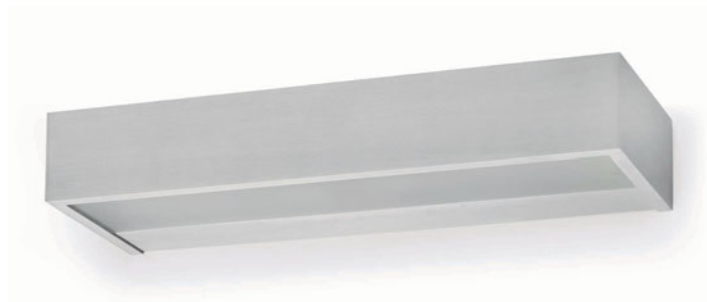
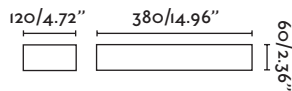

UP & DOWN
ARRIBA Y ABAJO

aMbo wall lamp

63201

polished aluminium
aluminio pulido

2X2G II MAX 24W NOT INCL. [97223024]
GEAR INCL.

ALUMINIUM + TRANSLUCENT GLASS /
ALUMINIO + CRISTAL TRANSLÚCIDO

A++ to E / 220-240V ~ 50-60 Hz / 2.54 kg / 5.60 lb

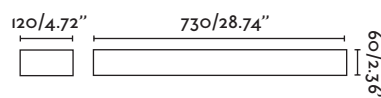

wall fixtures
apliques
appliques
lampade de parete

233



PLASTER WALL LAMPS

Plaster floodlight you can decorate to suit your space.

Luminaria de yeso que puedes decorar para adaptarla a tu espacio.

Luminaire en plâtre que vous pouvez décorer pour l'adapter à votre espace. Mettent en avant les espaces.

PLAST
YESO

[new] sNow wall lamp

63285



white
blanco

1 X E14 MAX 25W NOT INCL. [16321] [LED 17451]

PLAST /
YESO

A / 100-240V ~ 50-60 Hz / 1.43 kg / 3.15 lb

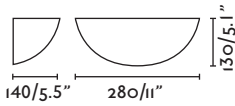

PLAST
YESO

UP & DOWN
ARRIBA Y ABAJO

[new] osLo wall lamp

63284



white
blanco

1 X G9 40W NOT INCL. [17440]

PLAST /
YESO

A++ to E / 100-240V ~ 50-60 Hz / 0.84 kg / 1.85 lb

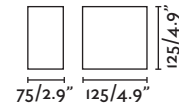

PLAST
YESO

UP & DOWN
ARRIBA Y ABAJO

LED

grOe wall lamp

63288



white
blanco

HIGH POWER LED 2W 3000K 200LM INCL.
DRIVER INCL.

PLAST /
YESO

A++ / 220-240V ~ 50-60 Hz / 1 kg / 2.20 lb



ø150/5.90" 50/1.96"



wall fixtures
appliques
appliques
lampade de parete



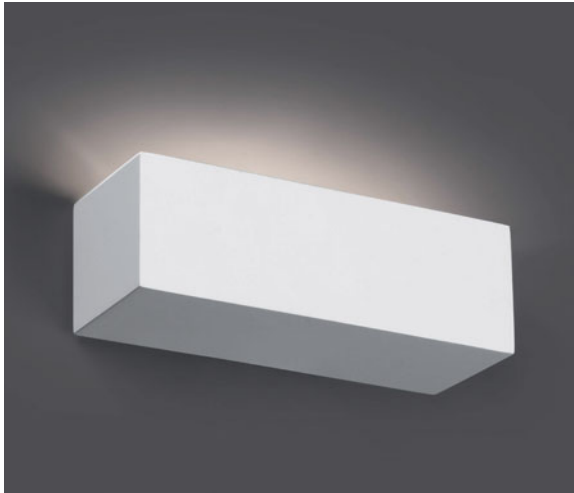

PLAST
YESO

eAco wall lamp

63176

○ white
blanco

1 XG9 MAX 40W NOT INCL. [15615] [LED 17440]

PLAST /
YESO

A++ to E / 100-240V ~ 50-60 Hz / 0.8 kg / 1.76 lb

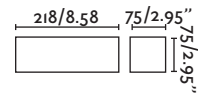

PLAST
YESO

eAco wall lamp

63178

○ white
blanco

1 XR7S JP78 MAX 100W NOT INCL. [12030]

PLAST /
YESO

A+++ to E / 100-240V ~ 50-60 Hz / 1.92 kg / 4.23 lb

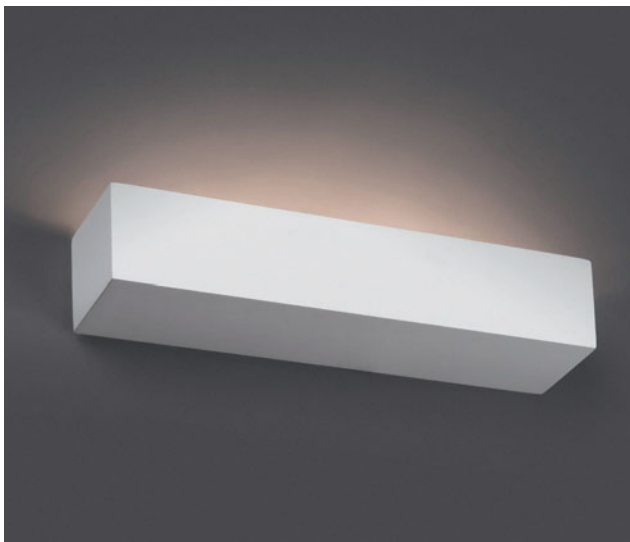
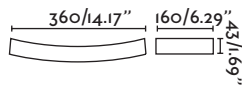

PLAST
YESO

eAco wall lamp

63177

○ white
blanco

2 XG9 MAX 40W NOT INCL. [15615] [LED 17440]

PLAST /
YESO

A+++ to E / 100-240V ~ 50-60 Hz / 1.4 kg / 3.09 lb

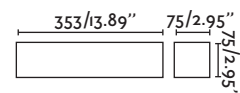



PLAST UP & DOWN
YESO ARRIBA Y ABAJO

chEras wall lamp

63175

○ white
blanco

1XR7S JP78 MAX 100W NOT INCL. [I2030]

PLAST /
YESO

A++ to E / 100-240V ~ 50-60 Hz / 1.9 kg / 4.19 lb

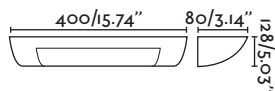

PLAST YESO UP & DOWN ARRIBA Y ABAJO

chEras wall lamp

63173  white
blanco

1 XR7S JP78 MAX 100W NOT INCL. [I2030]

PLAST /
YESO

A++ to E / 100-240V ~ 50-60 Hz / 1.1 kg / 2.43 lb

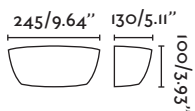

PLAST YESO UP & DOWN ARRIBA Y ABAJO

chEras wall lamp

63174  white
blanco

1 XG9 MAX 40W NOT INCL. [I5615] [LED 17440]

PLAST /
YESO

A++ to E / 220-240V ~ 50-60 Hz / 0.83 kg / 1.83 lb

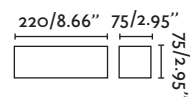

PLAST YESO

chEras wall lamp

63172  white
blanco

1 XR7S JP78 MAX 100W NOT INCL. [I2030]

PLAST /
YESO

A++ to E / 100-240V ~ 50-60 Hz / 1.94 kg / 4.28 lb

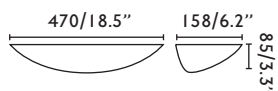

wall fixtures
apliques
appliques
lampade de parete



UP & DOWN
ARRIBA Y ABAJO

Twin wall lamp

OUT OF CATALOGUE
DESCATALOGADO

66187



matt nickel
níquel mate

1 XG9 MAX 50W NOT INCL. [LED 17440]

METAL + TRANSLUCENT GLASS /
METAL + CRISTAL TRANSLÚCIDO

A++ to E / 100-240V ~ 50-60 Hz / 1.58 kg / 3.48 lb

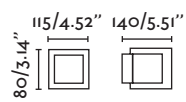



Twin

by Manel Llusçà

wall lamp

66185



matt nickel
níquel mate

66186



rust brown
marrón óxido

2XE I4 MAX 40W NOT INCL. [I6321] [LED I7451]

METAL + TRANSLUCENT GLASS /
METAL + CRISTAL TRANSLÚCIDO

A++ to E / 100-240V ~ 50-60 Hz / 1.8 kg / 3.97 lb

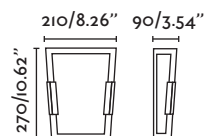

Twin

by Manel Llusçà

wall lamp

66183



matt nickel
níquel mate

66184



rust brown
marrón óxido

2XE27 MAX 60W NOT INCL. [I6292] [LED I7452]

METAL + TRANSLUCENT GLASS /
METAL + CRISTAL TRANSLÚCIDO

A++ to E / 100-240V ~ 50-60 Hz / 1.8 kg / 3.97 lb

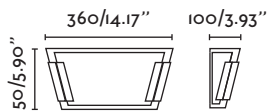

conO

wall lamp

66137



rust brown
marrón óxido

2XE I4 MAX 60W NOT INCL. [I6321] [LED I7450]

METAL + RUSTIC GLASS /
METAL + CRISTAL RÚSTICO

A++ to E / 100-240V ~ 50-60 Hz / 1.5 kg / 3.31 lb

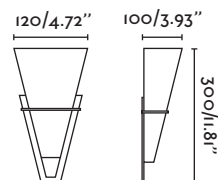



UP & DOWN
ARRIBA Y ABAJO

geNaker wall lamp

29003



grey
gris

1XR7S.JP78 MAX 70W NOT INCL. [I2030]

METAL + TRANSLUCENT GLASS /
METAL + CRISTAL TRANSLÚCIDO

A++ to E / 100-240V ~ 50-60 Hz / 0.91 kg / 2.01 lb

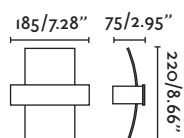



áNgulo wall lamp

63069



2XE14 MAX 40W NOT INCL. [16321] [LED 17451]
METAL + STAINLESS STEEL + TRANSLUCENT GLASS /
METAL + ACERO INOXIDABLE + CRISTAL TRANSLÚCIDO
A++ to E / 100-240V ~ 50-60 Hz / 0.93 kg / 2.05 lb

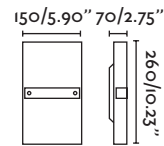

veRa wall lamp

63027



1XE27 MAX 60W NOT INCL. [16292] [LED 17452]
STEEL + TRANSLUCENT GLASS /
ACERO + CRISTAL TRANSLÚCIDO
A++ to E / 100-240V ~ 50-60 Hz / 0.51 kg / 1.12 lb



SALE: 10 UNITS AND MULTIPLES OF 10 / VENTA: 10 UDS Y MÚLTIPLOS DE 10
VENTE: 10 UNITÉS ET MULTIPLES DE 10 / VENDITA: 10 UNITÀ E MULTIPLI DI 10.

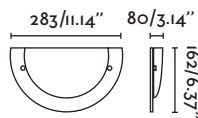

ibiScus wall lamp

63151



1XE27 MAX 60W NOT INCL. [16292] [LED 17452]
METAL + TRANSLUCENT GLASS /
METAL + CRISTAL TRANSLÚCIDO
A++ to E / 100-240V ~ 50-60 Hz / 1.1 kg / 2.43 lb

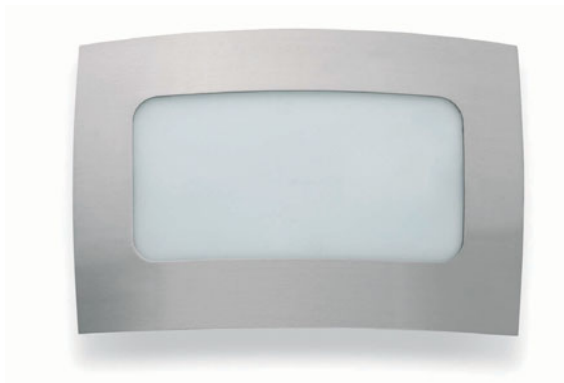
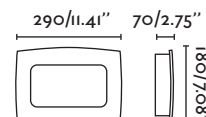



LiRia wall lamp

63156



matt nickel
níquel mate

1 X E27 MAX 60W NOT INCL. [I16292] [LED I7452]

METAL + OPAL GLASS /
METAL + CRISTAL OPAL

A++ to E / 100-240V ~ 50-60 Hz / 0.8 kg / 1.76 lb

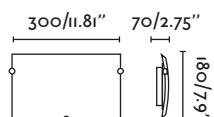

siNtra wall lamp

63040

 matt nickel
níquel mate

1XE14 MAX 40W NOT INCL. [I632I] [LED I745I]

METAL + OPAL GLASS /
METAL + CRISTAL OPAL

A++ to E / 100-240V ~ 50-60 Hz / 0.63 kg / 1.39 lb

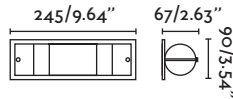

siNtra wall lamp

63041

 matt nickel
níquel mate

2XE14 MAX 40W NOT INCL. [I632I] [LED I745I]

METAL + OPAL GLASS /
METAL + CRISTAL OPAL

A++ to E / 100-240V ~ 50-60 Hz / 0.9 kg / 1.98 lb

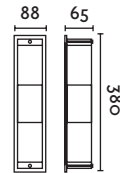

porTos wall lamp

63105

 grey
gris

1XT5 I3W INCL.
GEAR INCL.

METAL + ALUMINIUM /
METAL + ALUMINIO

A to B / 220-240V ~ 50-60 Hz / 2.42 kg / 5.34 lb

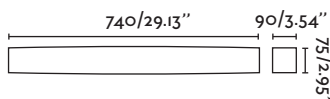



diuLa wall lamp

62987

● matt nickel
níquel mate

1XE27 MAX 60W NOT INCL. [16292] [LED 17453]

METAL + TRANSLUCENT GLASS /
METAL + CRISTAL TRANSLÚCIDO

A++ to E / 100-240V ~ 50-60 Hz / 1.05 kg / 2.31 lb

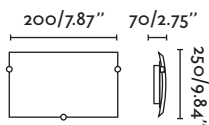

diuLa wall lamp

62986

● matt nickel
níquel mate

2XE27 MAX 60W NOT INCL. [16292] [LED 17453]

METAL + TRANSLUCENT GLASS /
METAL + CRISTAL TRANSLÚCIDO

A++ to E / 100-240V ~ 50-60 Hz / 1.8 kg / 3.97 lb

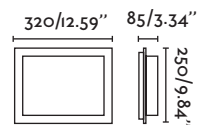

eQui wall lamp

OUT OF CATALOGUE
DESCATALOGADO

63053

● matt nickel
níquel mate

1XE27 MAX 60W NOT INCL. [16292] [LED 17453]

METAL + OPAL GLASS /
METAL + CRISTAL OPAL

A++ to E / 100-240V ~ 50-60 Hz / 0.81 kg / 1.79 lb

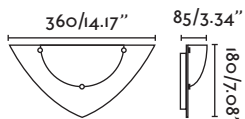

dAta wall lamp

63090

● matt nickel
níquel mate

1XE27 MAX 60W NOT INCL. [16292] [LED 17453]

STEEL + TRANSLUCENT GLASS /
ACERO + CRISTAL TRANSLÚCIDO

A++ to E / 100-240V ~ 50-60 Hz / 0.7 kg / 1.54 lb

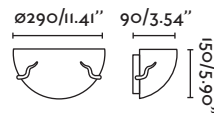



Ola wall lamp

63064



matt nickel
níquel mate

1XE I4 MAX 60W NOT INCL. [16321] [LED I7451]

STEEL + TRANSLUCENT GLASS /
ACERO + CRISTAL TRANSLÚCIDO

A++ to E / 100-240V ~ 50-60 Hz / 0.9 kg / 1.98 lb



Ola wall lamp

63065



matt nickel
níquel mate

2XE I4 MAX 60W NOT INCL. [16321] [LED I7451]

STEEL + TRANSLUCENT GLASS /
ACERO + CRISTAL TRANSLÚCIDO

A++ to E / 100-240V ~ 50-60 Hz / 1.43 kg / 3.15 lb

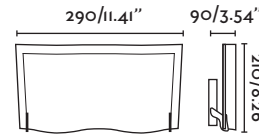

sunNy wall lamp

63046



chrome
cromo

1XE I4 MAX 40W NOT INCL. [16321] [LED I7451]

METAL + TRANSLUCENT GLASS /
METAL + CRISTAL TRANSLÚCIDO

A++ to E / 100-240V ~ 50-60 Hz / 0.6 kg / 1.32 lb

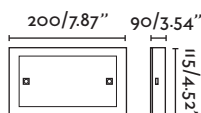

sunNy wall lamp

63047



chrome
cromo

2XE I4 MAX 40W NOT INCL. [16321] [LED I7451]

METAL + TRANSLUCENT GLASS /
METAL + CRISTAL TRANSLÚCIDO

A++ to E / 100-240V ~ 50-60 Hz / 1.1 kg / 2.43 lb

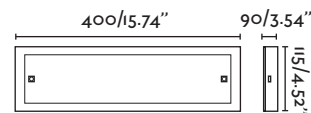



WALL LAMP PICTURES

A point of light on a picture lets you enhance it, especially in passageways.

Un punto de luz sobre un cuadro te permitirá realzarlo, especialmente en zonas de paso.

Un point de lumière sur un tableau vous permettra de le mettre en avant, en particulier dans des zones de passage.



dEgas wall lamp pictures

61070



1 X T5 8W 2700K INCL.
GEAR INCL.

METAL /
METAL

A to B / 220-240V ~ 50-60 Hz / 0.7 kg / 1.54 lb

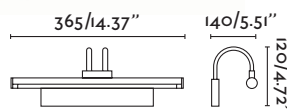

dEgas wall lamp pictures

61071



1 X T5 13W 2700K INCL.
GEAR INCL.

METAL /
METAL

A to B / 220-240V ~ 50-60 Hz / 0.88 kg / 1.94 lb

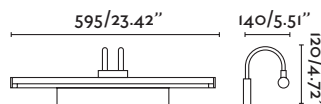

LED

kLimt wall lamp pictures

61048



61049

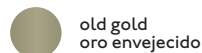

SMD LED 6W 3000K 429LM INCL.
DRIVER INCL.

ALUMINIUM + POLYCARBONATE /
ALUMINIO + POLICARBONATO

A++ / 220-240V ~ 50-60 Hz / 1 kg / 2.20 lb

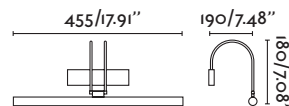



BULB INCLUDED
BOMBILLA INCLUIDA

luMiere wall lamp pictures

61066

● matt nickel
níquel mate

2XG9 40W INCL. [I7440]

METAL /
METAL

A to D / 220-240V ~ 50-60 Hz / 0.78 kg / 1.72 lb

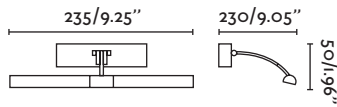

LED

heNlein wall lamp pictures

61064

● matt nickel
níquel mate

SMD LED 3W 4100K 192LM INCL.
DRIVER INCL.

METAL /
METAL

A++ / 220-240V ~ 50-60 Hz / 0.65 kg / 1.43 lb



DRIVER ✓

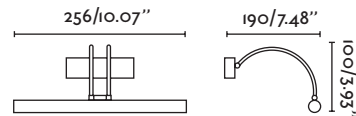

LED

[new] mOnet wall lamp pictures

61068

● matt nickel
níquel mate

SMD LED 6W 3000K 360LM INCL.
DRIVER INCL.

METAL /
METAL

A+++ to A / 100-240V ~ 50-60 Hz / 0.59 kg / 1.30 lb





























DRIVER ✓



wall fixtures
apliques
appliques
lampade de parete

ceiling fixtures

plafones/plafonnier/plafoniere

 acaCia	269	 kaLO	276
 adrA	266	 lEni	265
 aMi	265	 liChi	261
 aSpa	278	 liRia	271
 aZor	273	 nAn	259
 coPic	259	 pOte	263
 daNte	269	 reL [new]	260
 dAta	268	 ronDa	267
 dinO	269	 sQuad	256
 fuJi	265	 teCto	254
 halCón	272	 tiDa	270
 ibiScus	271	 veRa	267
 jaNet [new]	262	 yUca	268



CEILING LIGHTING FIXTURES



ceiling fixtures
plafones
plafonnier
plafoniere





[new] **teCto AR111**
ceiling lamp

63274



white
blanco

63275



black
negro



1 X AR III 50W NOT INCL. [LED 17513]
DRIVER NOT INCL. [98111050]



ALUMINIUM /
ALUMINIO

A++ to E / 12V / 0.4 kg / 0.88 lb



120/4.3"
135/5.5" 135/5.5"

[new] **teCto**
ceiling lamp

- 63272  white
blanco
- 63273  black
negro



2XGU10 50W NOT INCL. [LED 17310]

ALUMINIUM /
ALUMINIO

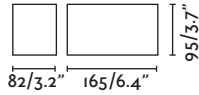
A++ to E / 100-240V ~ 50-60 Hz / 0.63 kg / 1.39 lb



[new] **teCto**
ceiling lamp

- 63270  white
blanco
- 63271  black
negro



1 XGU10 50W NOT INCL. [LED 17310]

ALUMINIUM /
ALUMINIO

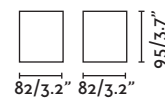
A++ to E / 100-240V ~ 50-60 Hz / 0.4 kg / 0.88 lb



[new] **teCto AR111**
ceiling lamp

- 63276  white
blanco
- 63277  black
negro

2XAR111 50W NOT INCL. [LED 17513]
DRIVER NOT INCL. [98111050]

ALUMINIUM /
ALUMINIO

A++ to E / 12V / 0.63 kg / 1.39 lb

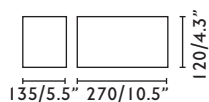



sQuad ceiling lamp

63216



matt white
blanco mate

63239



polished aluminium
aluminio pulido

1 XGU10 MAX 35W NOT INCL. [LED 14140]

ALUMINIUM + STEEL /
ALUMINIO + ACERO

A++ to E / 100-240V ~ 50-60 Hz / 0.34 kg / 0.75 lb



70/2.7"





sQuad ceiling lamp

63215



matt white
blanco mate

63238



polished aluminium
aluminio pulido

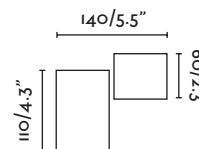

1 XGU10 MAX 50W NOT INCL. [LED I4140]

ALUMINIUM + STEEL /
ALUMINIO + ACERO

A++ to E / 100-240V ~ 50-60 Hz / 0.59 kg / 1.30 lb



sQuad ceiling lamp

63217



matt white
blanco mate

63218



matt white
blanco mate

63240



polished aluminium
aluminio pulido

1 XGU10 MAX 35W NOT INCL. [LED I4140]

ALUMINIUM + STEEL /
ALUMINIO + ACERO

A++ to E / 100-240V ~ 50-60 Hz / 0.48 kg / 1.06 lb

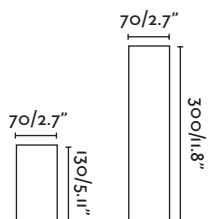

REF. 63217
REF. 63240

REF. 63218

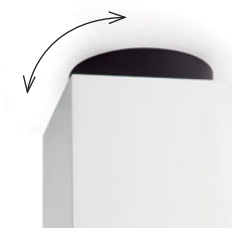

ROTATING BASE
BASE CON ROTACIÓN







nAn ceiling lamp

64190



white
blanco

1 XGU10 MAX 50W NOT INCL. [LED 17310]

ALUMINIUM /
ALUMINIO

A++ to E / 100-240V ~ 50-60 Hz / 0.49 kg / 1.08 lb



coPic ceiling lamp

63236



matt white
blanco mate

63237



matt black
negro mate

COB LED 7W 3000K 600LM INCL.
DRIVER INCL.

ALUMINIUM /
ALUMINIO

A++ / 220-240V ~ 50-60 Hz / 0.6 kg / 1.32 lb



DRIVER 

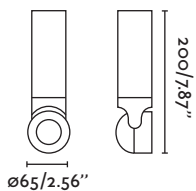



LED

[new] **reL**
ceiling lamp



64198  white
blanco

64199  black
negro

COB LED 15W 2700K 1340LM CRI>80 INCL.
ALUMINIUM /
ALUMINIO

100-240V ~ 50-60 Hz / 0.67 kg / 1.48 lb

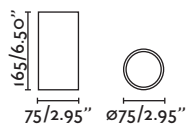

LED



[new] reL
ceiling lamp

64200  white
blanco

64201  black
negro

COB LED 25W 2700K 2230LM CRI>80 INCL.

ALUMINIUM /
ALUMINIO

100-240V ~ 50-60 Hz / 1 kg / 2.20 lb

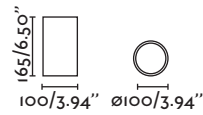

liChi
ceiling lamp

63117  white
blanco

1 XHIT-T G12 35W NOT INCL.
GEAR NOT INCL. [9841I035ST]

ALUMINIUM + TRANSPARENT GLASS + TRANSLUCENT POLYCARBONATE /
ALUMINIO + CRISTAL TRANSPARENTE + POLICARBONATO TRANSLÚCIDO

A++ to E / 220-240V ~ 50-60 Hz / 1.7 kg / 3.75 lb

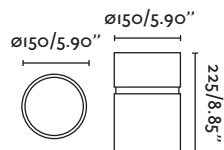



[new] **jaNet**
ceiling lamp

65136



white+red
blanco+rojo

65137



white+gold
blanco+oro

1 X E27 20W NOT INCL. [16219] [LED 17453]

METAL /
METAL

100-240V ~ 50-60 Hz / 0.45 kg / 0.99 lb

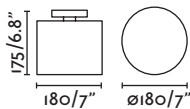



pOte ceiling lamp

- 63124  white
blanco
- 63125  black
negro
- 63126  grey
gris

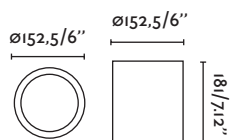

1XE27 MAX 60W NOT INCL.

ALUMINIUM /
ALUMINIO

A++ to E / 100-240V ~ 50-60 Hz / 0.57 kg / 1.26 lb



pOte ceiling lamp

- 63127  white
blanco
- 63128  black
negro
- 63129  grey
gris

2XE27 MAX 23W NOT INCL.

ALUMINIUM /
ALUMINIO

A++ to B / 100-240V ~ 50-60 Hz / 0.57 kg / 1.26 lb

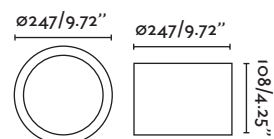



CEILING LAMPS

Placing a ceiling light on the ceiling will give you even and natural light.

Colocando un plafón en el techo conseguirás luz ambiental e uniforme.

En plaçant un plafonnier au plafond vous obtiendrez une lumière d'ambiance et uniforme.



fuJi ceiling lamp

63230



1 XR7S JP II7 MAX 150W NOT INCL. [12034]

ALUMINIUM + OPAL GLASS /
ALUMINIO + CRISTAL OPAL

A++ to E / 100-240V ~ 50-60 Hz / 2 kg / 4.41 lb

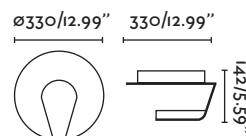

LEni ceiling lamp

61005



61006



1XE27 MAX 15W NOT INCL. [16166] [LED 17453]

PVC /
PVC

A++ to B / 100-240V ~ 50-60 Hz / 0.6 kg / 1.32 lb

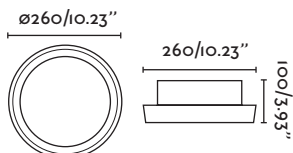

[new] aMi ceiling lamp

63398

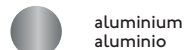

SMD LED 15W 2700K 1200LM CRI>80 INCL.
DRIVER INCL.

ALUMINIUM + PVC /
ALUMINIO + PVC

A+ / 220-240V ~ 50-60 Hz / 2.5 kg / 5.51 lb

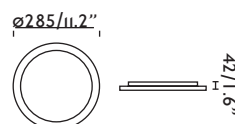



**BULB INCLUDED
BOMBILLA INCLUIDA**

adrA ceiling lamp-p

63075



1 X G10Q MAX 22W INCL. [15850]
GEAR INCL.

STEEL + OPAL ACRYLIC /
ACERO + ACRÍLICO OPAL

A to B / 220-240V ~ 50-60 Hz / 0.75 kg / 1.65 lb

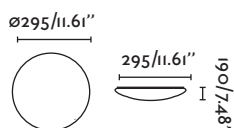

**BULB INCLUDED
BOMBILLA INCLUIDA**

adrA ceiling lamp-g

63076



1 X G10Q MAX 32W INCL. [15852]
GEAR INCL.

STEEL + OPAL ACRYLIC /
ACERO + ACRÍLICO OPAL

A to B / 220-240V ~ 50-60 Hz / 1 kg / 2.20 lb

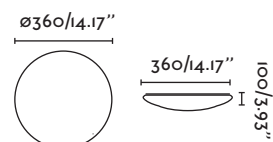

LED

[new] ronDa ceiling lamp-p

63309



white
blanco

SMD LED 12W 4000K 900LM CRI>80 INCL.
DRIVER INCL.

ALUMINIUM + ACRYLIC /
ALUMINIO + ACRÍLICO

A / 100-240V ~ 50-60 Hz / 0.54 kg / 1.19 lb

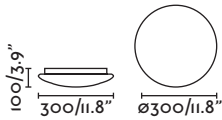

LED

[new] ronDa ceiling lamp-g

63310



white
blanco

SMD LED 24W 4000K 1500LM CRI>80
INCL. DRIVER INCL.

ALUMINIUM + ACRYLIC /
ALUMINIO + ACRÍLICO

A / 100-240V ~ 50-60 Hz / 0.8 kg / 1.76 lb

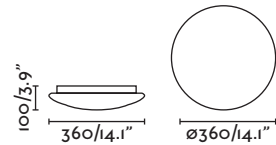

veRa ceiling lamp

63028



grey
gris

1 X E27 MAX 60W NOT INCL. [16292] [LED 17453]

STEEL + OPAL GLASS /
ACERO + CRISTAL OPAL

A++ to E / 100-240V ~ 50-60 Hz / 0.72 kg / 1.59 lb



SALE: 10 UNITS AND MULTIPLES OF 10 / VENTA: 10 UDS Y MÚLTIPLOS DE 10
VENTE: 10 UNITÉS ET MULTIPLES DE 10 / VENDITA: 10 UNITÀ E MULTIPLI DI 10.

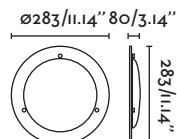

ceiling fixtures
plafones
plafonnier
plafoniere

267



dAta ceiling lamp-p

63087



matt nickel
níquel mate

1 XE27 MAX 60W NOT INCL. [16292] [LED 17453]

STEEL + TRANSLUCENT GLASS /
ACERO + CRISTAL TRANSLÚCIDO

A++ to E / 100-240V ~ 50-60 Hz / 0.61 kg / 1.34 lb



dAta ceiling lamp-m

63088



matt nickel
níquel mate

2 XE27 MAX 60W NOT INCL. [16292] [LED 17453]

STEEL + TRANSLUCENT GLASS /
ACERO + CRISTAL TRANSLÚCIDO

A++ to E / 100-240V ~ 50-60 Hz / 1.2 kg / 2.65 lb

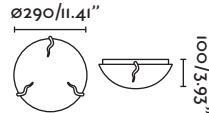

dAta ceiling lamp-g

63089



matt nickel
níquel mate

2 XE27 MAX 60W NOT INCL. [16292] [LED 17453]

STEEL + TRANSLUCENT GLASS /
ACERO + CRISTAL TRANSLÚCIDO

A++ to E / 100-240V ~ 50-60 Hz / 2 kg / 4.41 lb

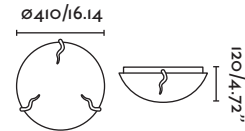

IP44

yUca ceiling lamp-p

63010



matt nickel
níquel mate

1 XG9 MAX 40W NOT INCL. [15615] [LED 17440]

METAL + OPAL GLASS /
METAL + CRISTAL OPAL

A++ to E / 100-240V ~ 50-60 Hz / 0.54 kg / 1.19 lb

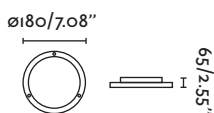

IP44

yUca ceiling lamp-m

63011



matt nickel
níquel mate

2 XE27 MAX 40W NOT INCL. [16292] [LED 17440]

METAL + OPAL GLASS /
METAL + CRISTAL OPAL

A++ to E / 100-240V ~ 50-60 Hz / 1.3 kg / 2.87 lb

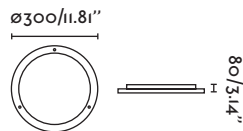

IP44

yUca ceiling lamp-g

63012

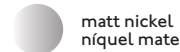

matt nickel
níquel mate

2 XE27 MAX 60W NOT INCL. [16292] [LED 17440]

METAL + OPAL GLASS /
METAL + CRISTAL OPAL

A++ to E / 100-240V ~ 50-60 Hz / 2.1 kg / 4.63 lb

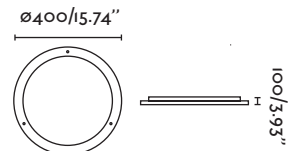



dinO **ceiling lamp-p**

63056  matt nickel
níquel mate

1 XE27 MAX 60W NOT INCL. [16197] [LED 17453]
METAL + OPAL GLASS /
METAL + CRISTAL OPAL

A++ to E / 100-240V ~ 50-60 Hz / 1.3 kg / 2.87 lb

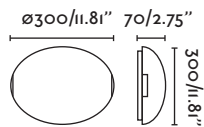

dinO **ceiling lamp-g**

63057  matt nickel
níquel mate

2 XE27 MAX 60W NOT INCL. [16197] [LED 17453]
METAL + OPAL GLASS /
METAL + CRISTAL OPAL

A++ to E / 100-240V ~ 50-60 Hz / 2.23 kg / 4.92 lb

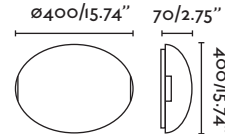

daNte **ceiling lamp**

61008  chrome
cromo

1 XE27 MAX 60W NOT INCL. [16292] [LED 17453]
STEEL + TRANSLUCENT GLASS /
ACERO + CRISTAL TRANSLÚCIDO

A++ to E / 100-240V ~ 50-60 Hz / 0.97 kg / 2.14 lb

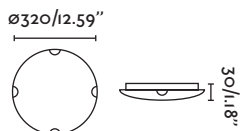

acaCia **ceiling lamp**

63084  matt nickel
níquel mate

2 XE27 MAX 60W NOT INCL. [16292] [LED 17453]
GLASS /
CRISTAL

A++ to E / 100-240V ~ 50-60 Hz / 1.99 kg / 4.39 lb

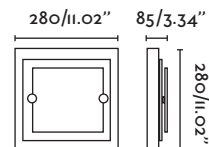



tiDa ceiling lamp

63052



matt nickel
níquel mate

1 X E27 MAX 60W NOT INCL. [I16292] [LED I7453]

METAL + OPAL GLASS /
METAL + CRISTAL OPAL

A++ to E / 100-240V ~ 50-60 Hz / 1.35 kg / 2.98 lb

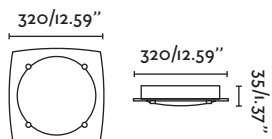



ibiScus ceiling lamp

63153

 matt nickel
níquel mate

2XE27 MAX 60W NOT INCL. [16292] [LED 17453]

METAL + OPAL GLASS /
METAL + CRISTAL OPAL

A++ to E / 100-240V ~ 50-60 Hz / 1.9 kg / 4.19 lb

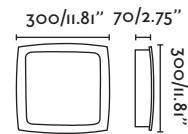

liRia ceiling lamp-p

63157

 matt nickel
níquel mate

2XE27 MAX 60W NOT INCL. [16292] [LED 17453]

METAL + TRANSLUCENT GLASS /
METAL + CRISTAL TRANSLÚCIDO

A++ to E / 100-240V ~ 50-60 Hz / 1.3 kg / 2.87 lb

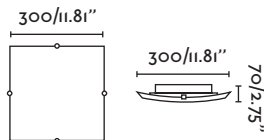

liRia ceiling lamp-g

63158

 matt nickel
níquel mate

2XE27 MAX 60W NOT INCL. [16292] [LED 17453]

METAL + TRANSLUCENT GLASS /
METAL + CRISTAL TRANSLÚCIDO

A++ to E / 100-240V ~ 50-60 Hz / 2.06 kg / 4.54 lb

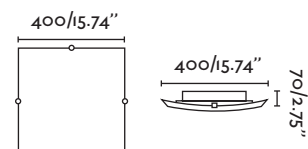



OUT OF CATALOGUE
DESCATALOGADO

halCón ceiling lamp

03020



polished aluminium
aluminio pulido

HF

03022



white
blanco

HF

2XT5 21W INCL.
GEAR INCL.

ALUMINIUM + PMMA /
ALUMINIO + PMMA

A to B / 220-240V ~ 50-60 Hz / 3.83 kg / 8.44 lb

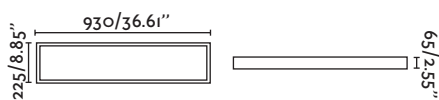

HF

Until stock exhaustion
Hasta final de stock
Jusqu'à la fin de stock



aZor ceiling lamp

03007



chrome+matt nickel
cromo+níquel mate

03008



chrome+dark brown
cromo+marrón oscuro

2X2G11 36W INCL. [15923]
GEAR INCL.

METAL + OPAL POLYCARBONATE /
METAL + POLICARBONATO OPAL

A to B / 220-240V ~ 50-60 Hz / 2.93 kg / 6.46 lb



BALLAST ✓

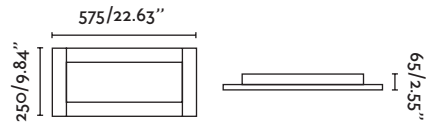

aZor ceiling lamp

03009



chrome+matt nickel
cromo+níquel mate

03010



chrome+dark brown
cromo+marrón oscuro

2X2G11 55W INCL. [15925]
GEAR INCL.

METAL + OPAL POLYCARBONATE /
METAL + POLICARBONATO OPAL

A to B / 220-240V ~ 50-60 Hz / 3.53 kg / 7.78 lb



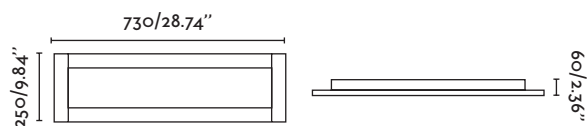

BALLAST ✓





aZor ceiling lamp

- 03015**  chrome+matt nickel
cromo+níquel mate
- 03016**  chrome+dark brown
cromo+marrón oscuro



1 XG10Q 22W NOT INCL. [15850]
+ 1 XT5 G10Q 32W NOT INCL. [15852]
GEAR INCL.

METAL + OPAL POLYCARBONATE /
METAL + POLICARBONATO OPAL

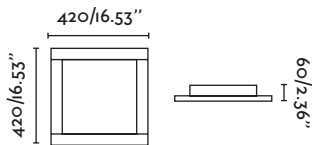
A to B / 220-240V ~ 50-60 Hz / 3.15 kg / 6.94 lb



aZor ceiling lamp

- 03013**  chrome+matt nickel
cromo+níquel mate
- 03014**  chrome+dark brown
cromo+marrón oscuro



3X2G11 36W INCL. [15923]
GEAR INCL.

METAL + OPAL POLYCARBONATE /
METAL + POLICARBONATO OPAL

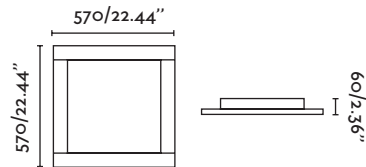
A to B / 220-240V ~ 50-60 Hz / 5.7 kg / 12.57 lb



aZor ceiling lamp

- 03011**  chrome+matt nickel
cromo+níquel mate
- 03012**  chrome+dark brown
cromo+marrón oscuro

4X2G11 36W INCL. [15923]
GEAR INCL.

METAL + OPAL POLYCARBONATE /
METAL + POLICARBONATO OPAL

A to B / 220-240V ~ 50-60 Hz / 4.78 kg / 10.54 lb

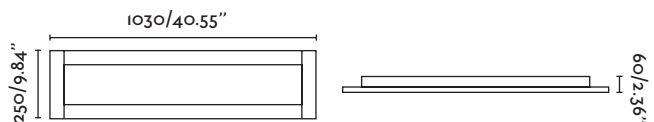



aZor ceiling lamp

03005 ● matt nickel
níquel mate

1 X T9 G 10 Q 32 W NOT INCL. + 1 X T9 G 10 Q 22 W NOT INCL.
GEAR INCL.

STEEL + OPAL PVC /
ACERO + PVP OPAL

A to B / 220-240V ~ 50-60 Hz / 3 kg / 6.61 lb

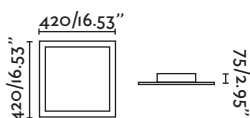

aZor ceiling lamp

03006 ● matt nickel
níquel mate

3 X 2 G II 24 W INCL.
GEAR INCL.

STEEL + OPAL PVC /
ACERO + PVP OPAL

A to B / 220-240V ~ 50-60 Hz / 4.8 kg / 10.58 lb

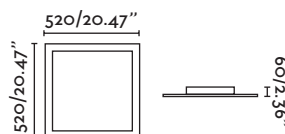

aZor ceiling lamp

03002 ● matt nickel
níquel mate

2 X 2 G II 24 W INCL.
GEAR INCL.

STEEL + OPAL PVC /
ACERO + PVP OPAL

A to B / 220-240V ~ 50-60 Hz / 2.4 kg / 5.29 lb

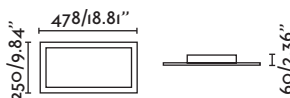

aZor ceiling lamp

03004 ● matt nickel
níquel mate

2 X 2 G II 55 W INCL.
GEAR INCL.

STEEL + OPAL PVC /
ACERO + PVP OPAL

A to B / 220-240V ~ 50-60 Hz / 3.5 kg / 7.72 lb

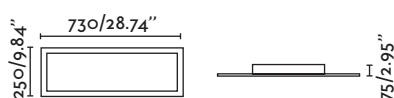



DUAL FUNCTION G9/LED
 FUNCION DUAL G9/LED

kaLO 
ceiling lamp

67001



4XG9 40W INCL. [I7440]
 + LED 3W INCL.
 DRIVER INCL.

METAL + TRANSPARENT GLASS /
 METAL + CRISTAL TRANSPARENTE

A++ to D / 220-240V ~ 50-60 Hz / 6.9 kg / 15.21 lb

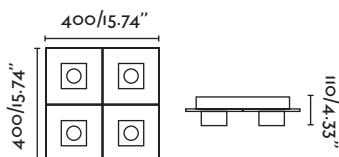

DUAL FUNCTION G9/LED
FUNCIÓN DUAL G9/LED

kalO

ceiling lamp

67000



1 X G9 40W INCL. [I7440]
+ LED RGB 0,84W INCL.
DRIVER INCL.

METAL + TRANSPARENT GLASS /
METAL + CRISTAL TRANSPARENTE

A++ to D / 220-240V ~ 50-60 Hz / 2.2 kg / 4.85 lb

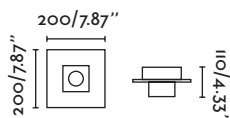

DUAL FUNCTION G9/LED
FUNCIÓN DUAL G9/LED

kalO

ceiling lamp

67002



9 X G9 40W INCL. [I7440]
+ LED RGB 7,56W INCL.
DRIVER INCL.

METAL + TRANSPARENT GLASS /
METAL + CRISTAL TRANSPARENTE

A++ to D / 220-240V ~ 50-60 Hz / 14 kg / 30.86 lb

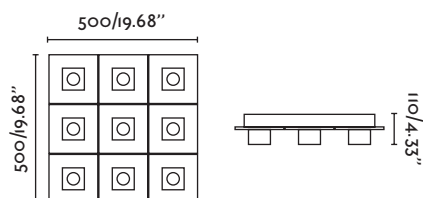

ceiling fixtures
plafones
plafonnier
plafoniere



aSpa ceiling lamp

OUT OF CATALOGUE
DESCATALOGADO

68433



chrome
cromo

HF

4XG9 MAX 40W NOT INCL. [15615] [LED 17440]

METAL + OPTICAL GLASS K9 /
METAL + CRISTAL ÓPTICO K9

A++ to E / 100-240V ~ 50-60 Hz / 1.92 kg / 4.23 lb

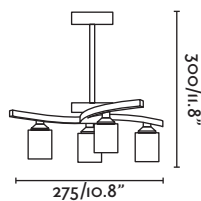



aSpa ceiling lamp

68434



chrome
cromo

HF

6XG9 MAX 40W NOT INCL. [I56I5] [LED I7440]

METAL + OPTICAL GLASS K9 /
METAL + CRISTAL ÓPTICO K9

A++ to E / 100-240V ~ 50-60 Hz / 3.1 kg / 6.83 lb

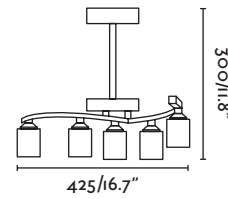

aSpa ceiling lamp

68432



chrome
cromo

OUT OF CATALOGUE
DESCATALOGADO

6XG9 MAX 40W NOT INCL. [I56I5] [LED I7440]

METAL + OPTICAL GLASS K9 /
METAL + CRISTAL ÓPTICO K9

A++ to C / 100-240V ~ 50-60 Hz / 2.5 kg / 5.51 lb

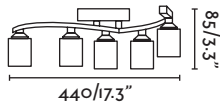







HF

Until stock exhaustion
Hasta final de stock
Jusqu'à la fin de stock

recessed

empotrables/encastrables/da incasso

 aRgón [new]	301	 nEón [new]	301
 carRé	310	 nEu	293
 dOt	289	 neutrÓN	305
 eMma	310	 nOrd [new]	293
 fiJo	308	 nUsa	289
 fLAt	283	 ónIce	304
 foNt [new]	285	 pLAno	302
 hELio	307	 pLas	295
 kiT	309	 plaTón	311
 kOi	291	 quArk	310
 led miNi	291	 rAdón [new]	299
 lUx	311	 tirSo	296
 maLmo [new]	292	 veGa	310
 moNt [new]	287	 yEs	293
 móVil	309	 zIrcón	305



RECESSED





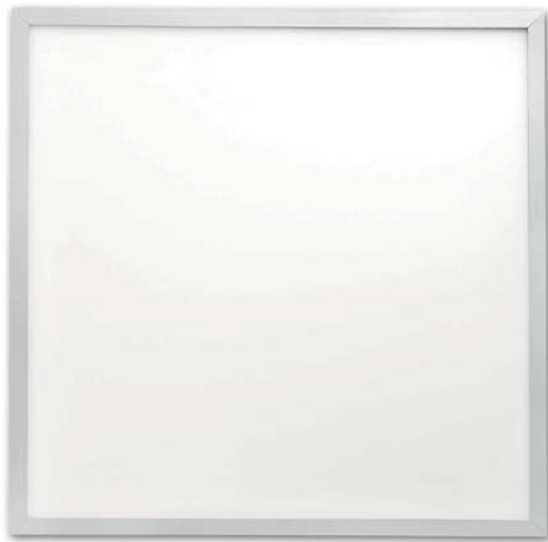

flAt recessed

42840	 aluminium aluminio	2700K	3100Lm
42841	 aluminium aluminio	4000K	3200Lm

SMD LED 48W INCL.
DRIVER 1400mA INCL.

ALUMINIUM + PMMA /
ALUMINIO + PMMA

A++ / 100-240V ~ 50-60 Hz / 4.1 kg / 9.04 lb

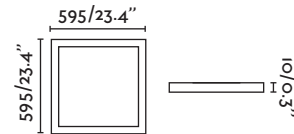

DRIVER DALI

98310589

DRIVER I-10V

98310689

KIT SUSPENSION FLAT /
KIT SUSPENSIÓN FLAT

42842

INCL.
4 TENSORS
4 TENSORES

STEEL /
ACERO





RECESSEDS

These recessed lights will let you illuminate a room in a very discreet and functional way.

Los empotrables te permitirán iluminar una estancia de la forma más discreta y funcional.

Les encastrables vous permettront d'éclairer une pièce de la façon la plus discrète et fonctionnelle.



[new] foNt
recessed 6W

42846		white blanco	3000K	380Lm
42847		white blanco	6000K	400Lm
42848		grey gris	3000K	380Lm
42849		grey gris	6000K	400Lm

SMD LED 6W INCL.

METAL + OPAL POLYCARBONATE /
METAL + POLICARBONATO OPAL

A+ / 100-240V ~ 50-60 Hz / 0.8 kg / 1.76 lb

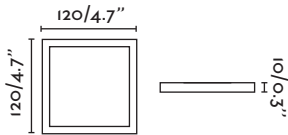

[new] foNt
recessed 12W

42850		white blanco	3000K	850Lm
42851		white blanco	6000K	890Lm
42852		grey gris	3000K	850Lm
42853		grey gris	6000K	890Lm

SMD LED 12W INCL.

METAL + OPAL POLYCARBONATE /
METAL + POLICARBONATO OPAL

A+ / 100-240V ~ 50-60 Hz / 0.9 kg / 1.98 lb

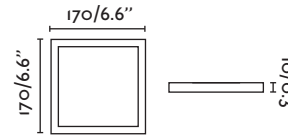

[new] foNt
recessed 18W

42854		white blanco	3000K	1200Lm
42855		white blanco	6000K	1250Lm
42856		grey gris	3000K	1200Lm
42857		grey gris	6000K	1250Lm

SMD LED 18W INCL.

METAL + OPAL POLYCARBONATE /
METAL + POLICARBONATO OPAL

A+ / 100-240V ~ 50-60 Hz / 1 kg / 2.20 lb

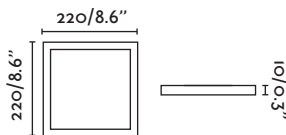

[new] foNt
recessed 25W

42858		white blanco	3000K	1900Lm
42859		white blanco	6000K	1990Lm
42860		grey gris	3000K	1900Lm
42861		grey gris	6000K	1990Lm

SMD LED 25W INCL.

METAL + OPAL POLYCARBONATE /
METAL + POLICARBONATO OPAL

A+ / 100-240V ~ 50-60 Hz / 1.12 kg / 2.47 lb

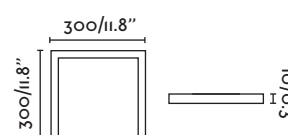



RECESSEDS

If what you need is to focus light on a point, installing a recessed light is a good choice.

Si lo que necesitamos es focalizar la luz en un punto, instalar un empotrable es una buena opción.

Si ce dont vous avez besoin est de focaliser la lumière sur un point, installer une lampe encastrable est une bonne option.



[new] moNt
recessed 6W

42862		white blanco	3000K	380Lm
42863		white blanco	6000K	400Lm
42864		grey gris	3000K	380Lm
42865		grey gris	6000K	400Lm

SMD LED 6W INCL.

METAL + POLYCARBONATE /
METAL + POLICARBONATO

A+ / 100-240V ~ 50-60 Hz / 0.30 kg / 0.66 lb

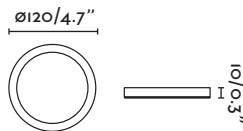

[new] moNt
recessed 12W

42866		white blanco	3000K	850Lm
42867		white blanco	6000K	890Lm
42868		grey gris	3000K	850Lm
42869		grey gris	6000K	890Lm

SMD LED 12W INCL.

METAL + POLYCARBONATE /
METAL + POLICARBONATO

A+ / 100-240V ~ 50-60 Hz / 0.35 kg / 0.77 lb

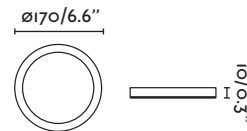

[new] moNt
recessed 18W

42870		white blanco	3000K	1200Lm
42871		white blanco	6000K	1250Lm
42872		grey gris	3000K	1200Lm
42873		grey gris	6000K	1250Lm

SMD LED 18W INCL.

METAL + POLYCARBONATE /
METAL + POLICARBONATO

A+ / 100-240V ~ 50-60 Hz / 0.40 kg / 0.88 lb

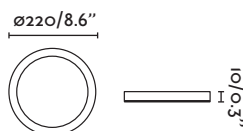

[new] moNt
recessed 25W

42874		white blanco	3000K	1900Lm
42875		white blanco	6000K	1990Lm
42876		grey gris	3000K	1900Lm
42877		grey gris	6000K	1990Lm

SMD LED 25W INCL.

METAL + POLYCARBONATE /
METAL + POLICARBONATO

A+ / 100-240V ~ 50-60 Hz / 0.44 kg / 0.97 lb

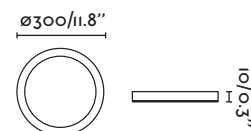



dOt recessed

42923  white
blanco 3000K

42924  white
blanco 5000K

SMD LED 24W 2400LM INCL.
DRIVER INCL.

ALUMINIUM + OPAL PMMA /
ALUMINIO + PMMA OPAL

A++ to A / 100-240V ~ 50-60 Hz / 0.6 kg / 1.32 lb



Ø139/5.47"

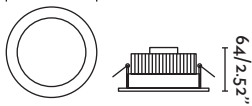

nUsa recessed

02090101  white
blanco 2700K

02090201  white
blanco 4000K

COB LED 7W 550LM INCL.
DRIVER INCL.

ALUMINIUM /
ALUMINIO

100-240V ~ 50-60 Hz / 0.3 kg / 0.66 lb

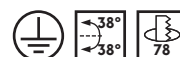

Ø90/3.54"

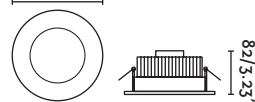

recessed
empotrables
encastrables
da incasso

289



kOi recessed

42921



SMD LED 6W 3000K 400LM INCL.
DRIVER INCL.

PVC + POLYCARBONATE /
PVC + POLICARBONATO

A / 100-240V ~ 50-60 Hz / 0.2 kg / 0.44 lb

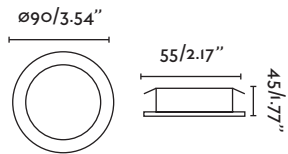

led miNi recessed

42910



42911



HIGH POWER LED 3,5W 3000K 200LM INCL.
DRIVER NOT INCL. [98310110]

METAL + TRANSLUCENT POLYCARBONATE /
METAL + POLICARBONATO TRANSLÚCIDO

A++ / 220-240V ~ 50 Hz / 0.1 kg / 0.22 lb

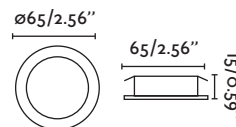

ACCESSORY / ACCESORIO

42912



42913



NOT INCL.
ALUMINIUM /
ALUMINIO
0.04 kg / 0.09 lb

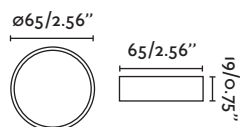

recessed
empotrables
encastrables
da incasso



PLAST
YESO

[new] **maLmo**
recessed

63289

○ white
blanco

SMD LED 9W 3000K 360LM INCL.
DRIVER DC 500mA NOT INCL. [98310316]

PLAST /
YESO

A++ / 220-240V ~ 50-60 Hz / 2.28 kg / 5.03 lb



DRIVER 

 305x185

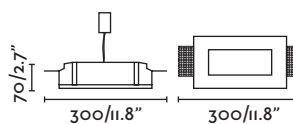



PLAST
YESO

nEu recessed

63286

white
blanco

I XMR I6 35W NOT INCL. [LED 14142]
GEAR NOT INCL. [43070]. LED [98101050]

PLAST /
YESO

A++ to E / 220-240V ~ 50-60 Hz / 0.9 kg / 1.98 lb

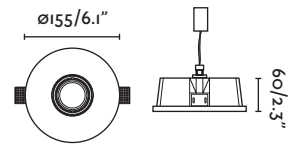

PLAST
YESO

yEs recessed

63280

white
blanco

I XAR III MAX 100W NOT INCL. [LED 17517]
GEAR NOT INCL. [98111105]. LED [98101050]

PLAST + ALUMINIUM /
YESO + ALUMINIO

A++ to E / 220-240V ~ 50-60 Hz / 1.8 kg / 3.97 lb

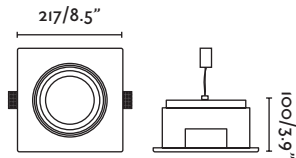
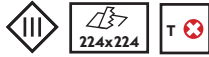

PLAST
YESO

[new] nOrd recessed

63290

white
blanco

SMD LED 18W 3000K 630LM INCL.
DRIVER DC 350mA NOT INCL. [98310125]

PLAST /
YESO

A++ / 32V ~ 50-60 Hz / 0.76 kg / 1.68 lb

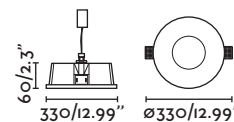

recessed
empotrables
encastrables
da incasso

293

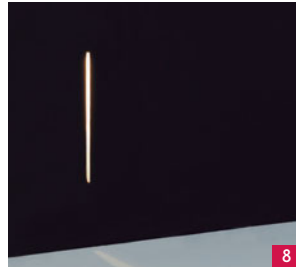
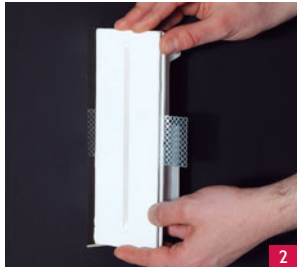

PLAST
YESO



pLas recessed

63281

white
blanco

HIGH POWER LED 1W 3000K I12LM INCL.
DRIVER NOT INCL. 350MA (46060)

PLAST /
YESO

A++ / 220-240V ~ 50-60 Hz / 0.6 kg / 1.32 Lb

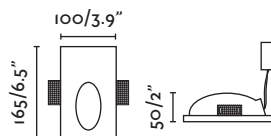

PLAST
YESO

pLas recessed

63282

white
blanco

HIGH POWER LED 1W 3000K I12LM INCL.
DRIVER NOT INCL. 350MA (46060)

PLAST /
YESO

A++ / 220-240V ~ 50-60 Hz / 0.7 kg / 1.54 Lb

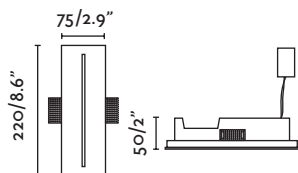

PLAST
YESO

pLas recessed

63283

white
blanco

HIGH POWER LED 1W 3000K I12LM INCL.
DRIVER NOT INCL. 350MA (46060)

PLAST /
YESO

A++ / 220-240V ~ 50-60 Hz / 0.57 kg / 1.26 Lb

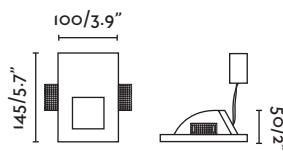

recessed
empotrables
encastrables
da incasso

295



tirSo recessed

46031

grey
gris

OUT OF CATALOGUE
DESCATALOGADO

IXG5.3 JCPIN MAX 50W NOT INCL. [12998] [LED 17442]
TRANSFORMER NOT INCL. [43070]. LED [98101050]

ALUMINIUM + ACRYLIC /
ALUMINIO + ACRÍLICO

A++ to E / 220-240V ~ 50-60 Hz / 0.43 kg / 0.95 lb

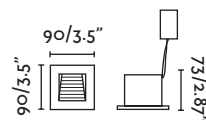



OUT OF CATALOGUE
DESCATALOGADO

tirSo recessed

46032

grey
gris

1 XG5.3 JCPIN MAX 50W NOT INCL. [I2998] [LED 17442]
TRANSFORMER NOT INCL. [43070]. LED [98101050]

ALUMINIUM + ACRYLIC /
ALUMINIO + ACRÍLICO

A++ to E / 220-240V ~ 50-60 Hz / 0.5 kg / 1.10 lb

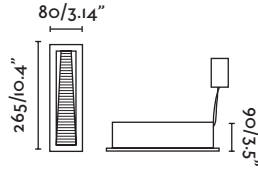

ACCESSORY / ACCESORIO

46034

grey
gris

NOT INCL.
0.7 kg / 1.54 lb

tirSo recessed

46029

grey
gris

1 XR7S JP I18 MAX 100W NOT INCL. [I2033]

ALUMINIUM + ACRYLIC /
ALUMINIO + ACRÍLICO

A++ to E / 220-240V ~ 50-60 Hz / 1.1 kg / 2.43 lb



46027

grey
gris

COB LED 3W 4200K 130LM INCL.
DRIVER INCL.

ALUMINIUM + ACRYLIC /
ALUMINIO + ACRÍLICO

A++ / 220-240V ~ 50-60 Hz / 1.2 kg / 2.65 lb



46030

grey
gris

1 XG24D-I 13W NOT INCL.
MAGNETIC GEAR INCL.

ALUMINIUM + ACRYLIC /
ALUMINIO + ACRÍLICO

A++ to B / 220-240V ~ 50-60 Hz / 1.37 kg / 3.02 lb

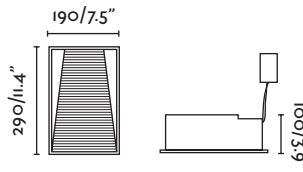

ACCESSORY / ACCESORIO



46028

grey
gris

OUT OF CATALOGUE
DESCATALOGADO

NOT INCL.
0.7 kg / 1.54 lb

recessed
empotrables
encastrables
da incasso



STRUCTURE
ESTRUCTURA



LED BULB
BOMBILLA LED
MRI16/GU10



HALOGEN LAMP
LAMPARA HALÓGENA
MRI16/GU10



LED MODULE
MÓDULO LED
I7500/I7501



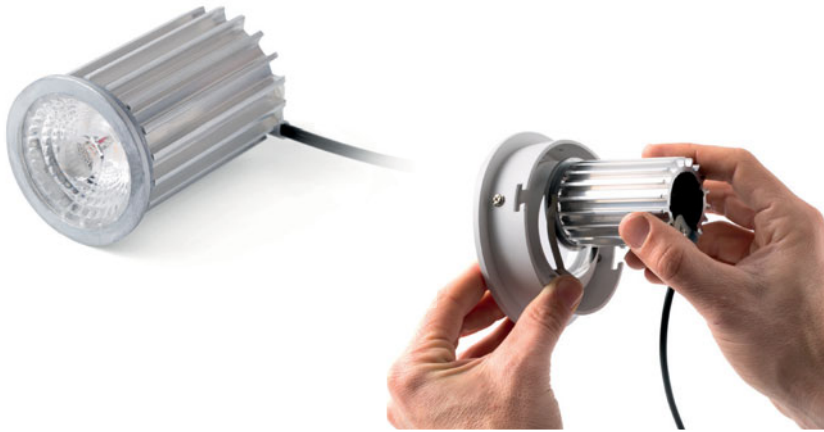

[new] COB LED MODULE 8W /
MÓDULO COB LED 8W

17500 2700K
17501 4000K

550LM 8W CRI>80
DRIVER INCL.

METAL + GLASS /
METAL + CRISTAL

A+ /100-240V

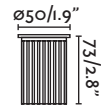

ORIENTABLE **HALOGEN/LED**

[new] **rAdón**
recessed

43396  white
blanco

43398  white
blanco

1 XMR 16 50W NOT INCL. [14108] [LED 14142]
TRANSFORMER NOT INCL. [43070]. LED [98111050]
SOCKET / PORTALÁMPARAS MR 16 4R033 NOT INCL.

OR 1 XGU 10 50W NOT INCL. [14100] [LED 17316]
SOCKET / PORTALÁMPARAS GU 10 43065 NOT INCL.

MODULE COB LED 8W 2700K [17500] 4000K [17501]
DRIVER INCL.

ALUMINIUM /
ALUMINIO

0.13 kg / 0.29 lb

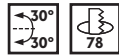

REF. 43396



REF. 43398

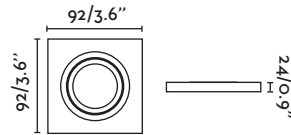

ORIENTABLE **HALOGEN/LED**

[new] **rAdón**
recessed

43397  white
blanco

2 XMR 16 50W NOT INCL. [14108] [LED 14142]
TRANSFORMER NOT INCL. [9811105]. LED [98111050]
SOCKET / PORTALÁMPARAS MR 16 4R033 NOT INCL.

OR 2 XGU 10 50W NOT INCL. [14100] [LED 17316]
SOCKET / PORTALÁMPARAS GU 10 43065 NOT INCL.

MODULE COB LED 8W 2700K [17500] 4000K [17501]
DRIVER INCL.

ALUMINIUM /
ALUMINIO

0.26 kg / 0.57 lb

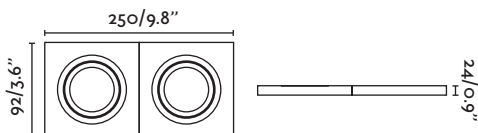
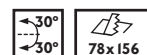

recessed
empotrables
encastrables
da incasso



STRUCTURE
ESTRUCTURA



LED BULB
BOMBILLA LED
MR16/GU10



HALOGEN LAMP
LAMPARA HALÓGENA
MR16/GU10



LED MODULE
MÓDULO LED
17500/17501



ORIENTABLE HALOGEN/LED



REF. 43401



REF. 43402

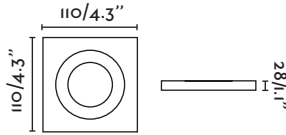
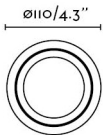

[new] aRgón recessed

43401 white
blanco

43402 white
blanco

1 XMR 16 50W NOT INCL. [14108] [LED 14142]
TRANSFORMER NOT INCL. [43070]. LED [98111050]
SOCKET / PORTALÁMPARAS MR 16 4R033 NOT INCL.

OR 1 XGU 10 50W NOT INCL. [14100] [LED 17316]
SOCKET / PORTALÁMPARAS GU 10 43065 NOT INCL.

MODULE COB LED 8W 2700K [17500] 4000K [17501]
DRIVER INCL.

ALUMINIUM /
ALUMINIO

0.24 kg / 0.53 lb

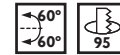

ORIENTABLE HALOGEN/LED

[new] aRgón recessed

43403 white
blanco

2 XMR 16 50W NOT INCL. [14108] [LED 14142]
TRANSFORMER NOT INCL. [9811105]. LED [98111050]
SOCKET / PORTALÁMPARAS MR 16 4R033 NOT INCL.

OR 2 XMR 16 LED 5W NOT INCL. [14142]
TRANSFORMER NOT INCL. [98111050]

OR 2 XGU 10 50W NOT INCL. [14100] [LED 17316]
SOCKET / PORTALÁMPARAS GU 10 43065 NOT INCL.

MODULE COB LED 8W 2700K [17500] 4000K [17501]
DRIVER INCL.

ALUMINIUM /
ALUMINIO

0.47 kg / 1.4 lb

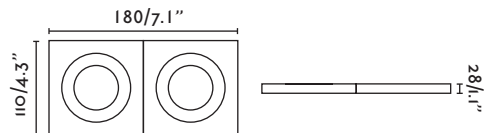

HALOGEN/LED

[new] nEón recessed

43399 white
blanco

43400 white
blanco

1 XMR 16 50W NOT INCL. [14108] [LED 14142]
TRANSFORMER NOT INCL. [43070]. LED [98111050]
SOCKET / PORTALÁMPARAS MR 16 4R033 NOT INCL.

OR 1 XGU 10 50W NOT INCL. [14100] [LED 17316]
SOCKET / PORTALÁMPARAS GU 10 43065 NOT INCL.

MODULE COB LED 8W 2700K [17500] 4000K [17501]
DRIVER INCL.

ALUMINIUM /
ALUMINIO

0.12 kg / 0.26 lb



REF. 43400



REF. 43399

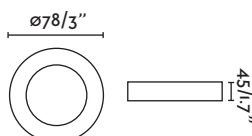
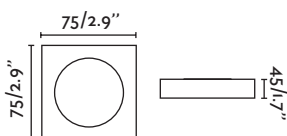

recessed
empotrables
encastrables
da incasso

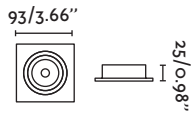

ORIENTABLE HALOGEN/LED

plAno recessed

43382 brushed aluminium
aluminio cepillado

43383 wenge
wengué

1 XMR16 50W NOT INCL. [14108] [LED 14142]
TRANSFORMER NOT INCL. [43070]. LED [98111050]
SOCKET / PORTALÁMPARAS MR16 4R033 INCL.

OR 1 XGU10 50W NOT INCL. [LED 17316]
SOCKET / PORTALÁMPARAS GU10 43065 NOT INCL.

OR MODULE COB LED 8W 2700K [17500] 4000K [17501]
DRIVER INCL.

ALUMINIUM /
ALUMINIO

A++ to E / 220-240V ~ 50-60 Hz / 0.18 kg / 0.40 lb



ORIENTABLE HALOGEN/LED

plAno recessed

43384 brushed aluminium
aluminio cepillado

2XMR16 50W NOT INCL. [14108] [LED 14142]
TRANSFORMER NOT INCL. [43070]. LED [98111050]
SOCKET / PORTALÁMPARAS MR16 4R033 INCL.

OR 2XGU10 50W NOT INCL. [LED 17316]
SOCKET / PORTALÁMPARAS GU10 43065 NOT INCL.

OR MODULE COB LED 8W 2700K [17500] 4000K [17501]
DRIVER INCL.

ALUMINIUM /
ALUMINIO

A++ to E / 220-240V ~ 50-60 Hz / 0.4 kg / 0.88 lb

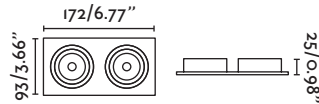

STRUCTURE
ESTRUCTURA



LED BULB
BOMBILLA LED
MR16/GU10



HALOGEN LAMP
LAMPARA HALÓGENA
MR16/GU10



LED MODULE
MÓDULO LED
17500/17501



ORIENTABLE

HALOGEN/LED



plAno recessed

43386



brushed aluminium
aluminio cepillado

3XMR 16 50W NOT INCL. [14108] [LED 14142]
TRANSFORMER NOT INCL. [43070]. LED [98111050]
SOCKET / PORTALÁMPARAS MR 16 4R033 INCL.

OR 3XGU 10 50W NOT INCL. [LED 17316]
SOCKET / PORTALÁMPARAS GU 10 43065 NOT INCL.
OR MODULE COB LED 8W 2700K [17500] 4000K [17501]
DRIVER INCL.

ALUMINIUM /
ALUMINIO

A++ to E / 220-240V ~ 50-60 Hz / 0.5 kg / 1.10 lb

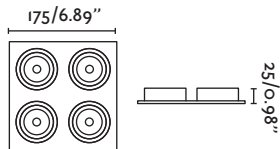
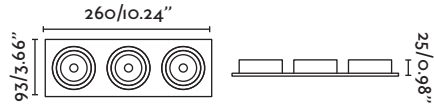

ORIENTABLE

HALOGEN/LED

plAno recessed

43388



brushed aluminium
aluminio cepillado

43389



wenge
wengué

4XMR 16 50W NOT INCL. [14108] [LED 14142]
TRANSFORMER NOT INCL. [43070]. LED [98111050]
SOCKET / PORTALÁMPARAS MR 16 4R033 INCL.

OR 4XGU 10 50W NOT INCL. [LED 17316]
SOCKET / PORTALÁMPARAS GU 10 43065 NOT INCL.
OR MODULE COB LED 8W 2700K [17500] 4000K [17501]
DRIVER INCL.

ALUMINIUM /
ALUMINIO

A++ to E / 220-240V ~ 50-60 Hz / 0.67 kg / 1.48 lb



STRUCTURE
ESTRUCTURA



LED BULB
BOMBILLA LED
MR16/GU10



HALOGEN LAMP
LAMPARA HALÓGENA
MR16/GU10



LED MODULE
MÓDULO LED
17500/17501



recessed
empotrables
encastrables
da incasso



HALOGEN/LED

ónIce recessed

43300  grey
gris

43301  white
blanco

1 XGU 10 50W NOT INCL. [LED 17316]

ALUMINIUM /
ALUMINIO

A++ to E / 100-240V ~ 50-60 Hz / 0.4 kg / 0.88 lb



90/3.54"

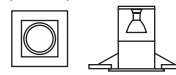

110/4.33"

HALOGEN/LED

ónIce recessed

43306  grey
gris

43307  white
blanco

4 XGU 10 50W NOT INCL. [LED 17316]

ALUMINIUM /
ALUMINIO

A++ to E / 100-240V ~ 50-60 Hz / 1.31 kg / 2.89 lb



165/6.50"

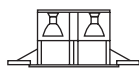

140/5.51"

HF

HF



HF

Until stock exhaustion
Hasta final de stock
Jusqu'à la fin de stock



BULB INCLUDED
BOMBILLA INCLUIDA

HALOGEN/LED

neutrón recessed

43071



matt nickel
níquel mate

1 XGU10 50W INCL. [LED 14140]

STAINLESS STEEL /
ACERO INOXIDABLE

A to D / 220-240V ~ 0.47 kg / 1.04 lb



100/3.94"



27/1.6"



HALOGEN/LED

zircón recessed

43315



grey
gris

1 XGU10 50W NOT INCL. [LED 14140]

ALUMINIUM /
ALUMINIO

A++ to E / 100-240V ~ 50-60 Hz / 0.8 kg / 1.76 lb



132/5.20"

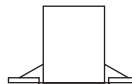

140/5.51"



BULB INCLUDED
BOMBILLA INCLUIDA

HALOGEN/LED

neutrón recessed

43072



matt nickel
níquel mate

2 XGU10 50W INCL. [LED 14140]

STAINLESS STEEL /
ACERO INOXIDABLE

A to D / 220-240V ~ 50-60 Hz / 0.8 kg / 1.76 lb



190/7.48"



27/1.6"



HALOGEN/LED

zircón recessed

43316



grey
gris

2 XGU10 50W NOT INCL. [LED 14140]

ALUMINIUM /
ALUMINIO

A++ to E / 100-240V ~ 50-60 Hz / 1.32 kg / 2.91 lb

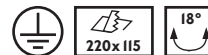

132/5.20"

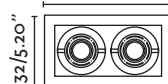

140/5.51"

recessed
empotrables
en castrables
da incasso

305

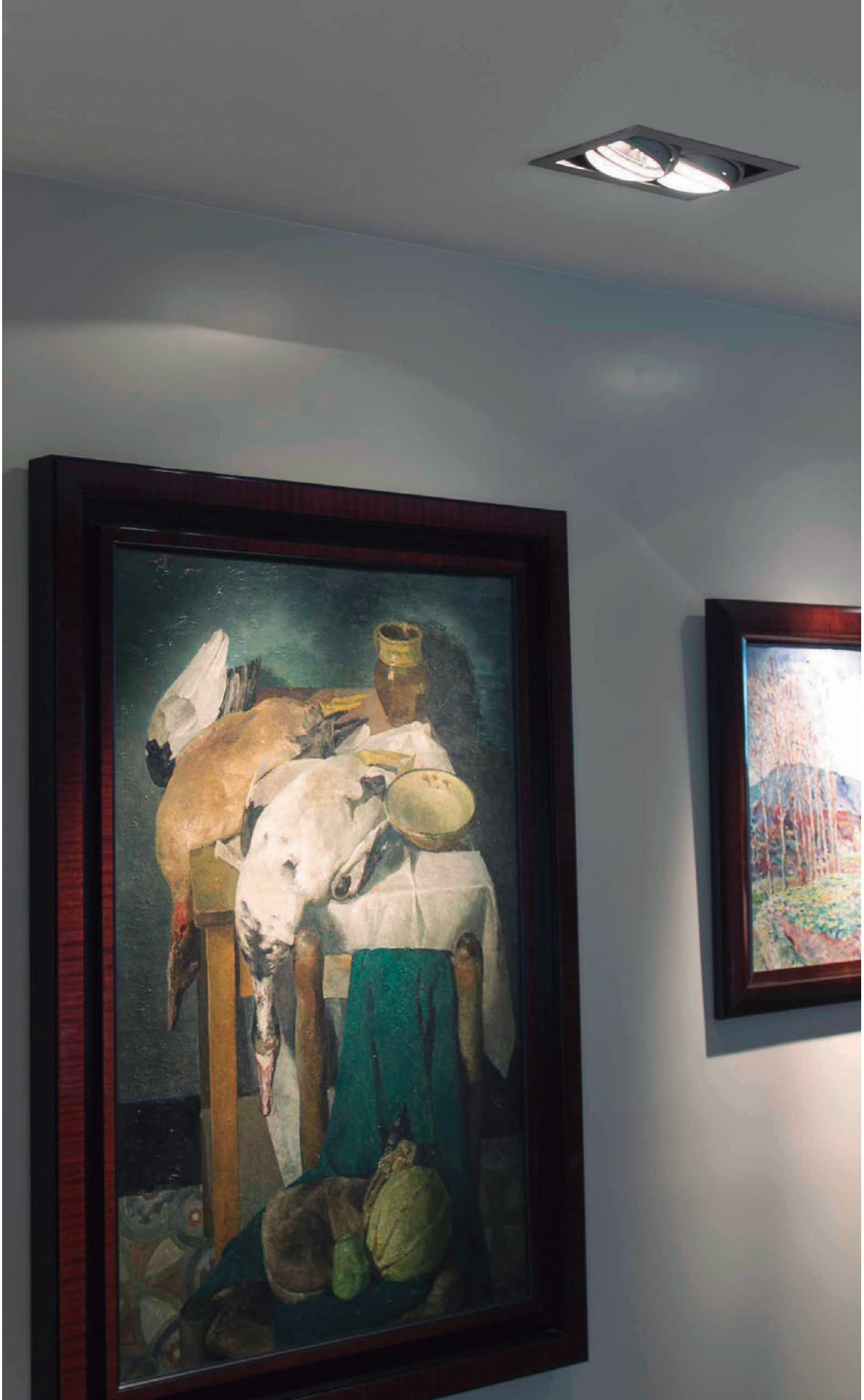

hElio recessed

43326



1XG53 AR I I MAX 50W NOT INCL. [14511] [LED 17512]
TRANSFORMER NOT INCL. [43070] [LED 9811050]

ALUMINIUM /
ALUMINIO

A++ to E / 12V ~ 50 Hz / 1.3 kg / 2.87 lb

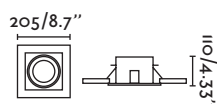

hElio recessed

43328



2XG53 AR III MAX 50W NOT INCL. [14511] [LED 17517]
2XTRANSFORMER NOT INCL. [43070] [LED 9811050]

ALUMINIUM /
ALUMINIO

A++ to E / 12V ~ 50 Hz / 2 kg / 4.41 lb

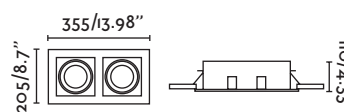



fiJo recessed

43050



white
blanco

43051



matt nickel
níquel mate

43053



aluminium
aluminio



1 XMR I6 50W NOT INCL.
TRANSFORMER NOT INCL. [43070].
SOCKET / PORTALÁMPARAS GU10 43065 NOT INCL.

ZAMAC /
ZAMAC

A++ to E / 220-240V ~ 50-60 Hz / 0.09 kg / 0.20 lb

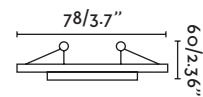

móVil

recessed

- 43056  white
blanco
- 43057  matt nickel
níquel mate
- 43058  old gold
oro envejecido
- 43059  aluminium
aluminio



1 XMR 16 50W NOT INCL. [LED 14142]
TRANSFORMER NOT INCL. [43070]. LED [98101050]
SOCKET / PORTALÁMPARAS GU 10 43065 NOT INCL.

ZAMAC /
ZAMAC

A++ to E / 220-240V ~ 50-60 Hz / 0.09 kg / 0.20 lb

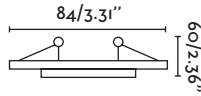

kiT GU10

- 43200A  white
blanco
- 43203A  matt nickel
níquel mate
- 43204  rust brown
marrón óxido

OUT OF CATALOGUE
DESCATALOGADO

OUT OF CATALOGUE
DESCATALOGADO

HF



1 XGU 10 50W INCL.
SOCKET / PORTALÁMPARAS GU 10 43065 INCL.

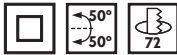

ZAMAC /
ZAMAC

A to D / 220-240V ~ 50-60 Hz / 0.2 kg / 0.44 lb



HF Until stock exhaustion
Hasta final de stock
Jusqu'à la fin de stock

kiT MR16

- 43210  white
blanco
- 43211  chrome
cromo

OUT OF CATALOGUE
DESCATALOGADO

HF



1 XMR 16 50W INCL. [LED 14142]
TRANSFORMER INCL. LED [98101050]

ZAMAC /
ZAMAC

A to D / 220-240V ~ 50-60 Hz / 0.22 kg /
0.49 lb



kiT GU10 LED

- 43215  white
blanco
- 43217  matt nickel
níquel mate

1 XGU 10 LED 3W 3000K 170LM INCL.
TRANSFORMER INCL.

ALUMINIUM /
ALUMINIO

A+++ to D / 220-240V ~ 50-60 Hz / 0.2 kg / 0.44 lb



kiT MR16 LED

- 43216  white
blanco

1 XMR 16 LED 3W 3000K 250LM 12V INCL.
DRIVER INCL.

ALUMINIUM /
ALUMINIO

0.96 kg / 2.12 lb

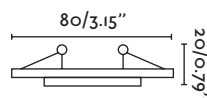



BULB INCLUDED
BOMBILLA INCLUIDA

quArk recessed

42906



matt nickel
níquel mate

1 XGU10 75W INCL.

ALUMINIUM /
ALUMINIO

A to D / 220-240V ~ 50-60 Hz / 0.37 kg / 0.82 lb



Ø105/4.13"



29/1.14"



veGa recessed

43004A



matt nickel
níquel mate

2 XG24 Q-3 26W INCL.
ELECTRONIC GEAR INCL.

METAL + GLASS /
METAL + CRISTAL

A to B / 220-240V ~ 50-60 Hz / 1.24 kg / 2.73 lb



Ø230/9.6"

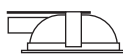
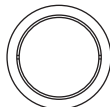

120/4.72"



carRé recessed

40160



grey
gris

HF

1 XMR16 50W NOT INCL. [LED 14142]

1 XMR16 50W

TRANSFORMER NOT INCL. [43070] [LED 98101050]

METAL /
METAL

A++ to E / 220-240V ~ 50-60 Hz / 0.34 kg / 0.75 lb



100/3.94"



105/4.13"

HF

Until stock exhaustion
Hasta final de stock
Jusqu'à la fin de stock



BULB INCLUDED
BOMBILLA INCLUIDA

eMma recessed

43016



matt nickel
níquel mate

2XE27 23W INCL.

METAL + TRANSLUCENT GLASS /
METAL + CRISTAL TRANSLÚCIDO

A+ to B / 220-240V ~ 50 Hz / 2 kg / 4.41 lb



230/9.6"

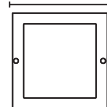

140/5.51"

plaTón recessed

42801



grey
gris

HF



2XE27 MAX 13W NOT INCL. [16466]

METAL + TRANSLUCENT GLASS /
METAL + CRISTAL TRANSLÚCIDO

A to B / 100-240V ~ 50-60 Hz / 0.9 kg / 1.98 lb

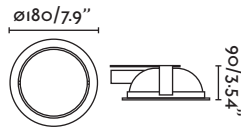

HF

Until stock exhaustion
Hasta final de stock
Jusqu'à la fin de stock



LUx recessed

02010401



white
blanco

Magnetic

02010301



white
blanco

Magnetic

02010404



grey
gris

Magnetic

02010304



grey
gris

Magnetic

02010201



white
blanco

Electronic

02010101



white
blanco

Electronic

02010204



grey
gris

Electronic

02010104



grey
gris

Electronic

2XG24D-2 18W 2400LM NOT INCL.
GEAR INCL. [ELT]

METAL + GLASS /
METAL + CRISTAL

A+++ to B / 220-240V ~ 50-60 Hz / 2.44 kg / 5.38 lb



2XG24D-3 26W 3600LM NOT INCL.
GEAR INCL. [ELT]

METAL + GLASS /
METAL + CRISTAL



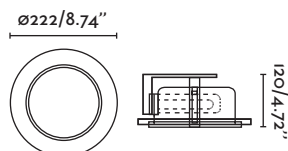

























A+++ to B / 220-240V ~ 50-60 Hz / 2.55 kg / 5.62 lb



recessed
empotrables
encastrables
da incasso

bathroom

baño/salle de bain/bagno

 baTh-3	339	 lAss	327
 bOden	331	 loGos	333
 caLda	319	 milD	314
 clEan	329	 naRa	339
 clOe [new]	328	 nlger	325
 cOra	330	 quaSar	341
 danA	341	 reLax	325
 dokA	323	 sirEt [new]	317
 eBba	339	 tEd	337
 eVa	342	 teRma	319
 ikOn	314	 tiMe	319
 iNdo	327	 tOd	337
 kanT	341	 tOla	335
 KaO	329	 yUca	329
 laoS	321		



BATHROOM

bathroom
baño
salle de bain
bagno



ikOn & mild

by Estudi Ribaudí

Designs for bathrooms which aim to soften the hardness of these spaces, creating a friendlier personality.

Diseños para baño que buscan suavizar la dureza de estos espacios, creando una personalidad propia más amable.

Conçues pour des salles de bains qui recherchent à adoucir la dureté de ces espaces, en créant une personnalité propre plus aimable.



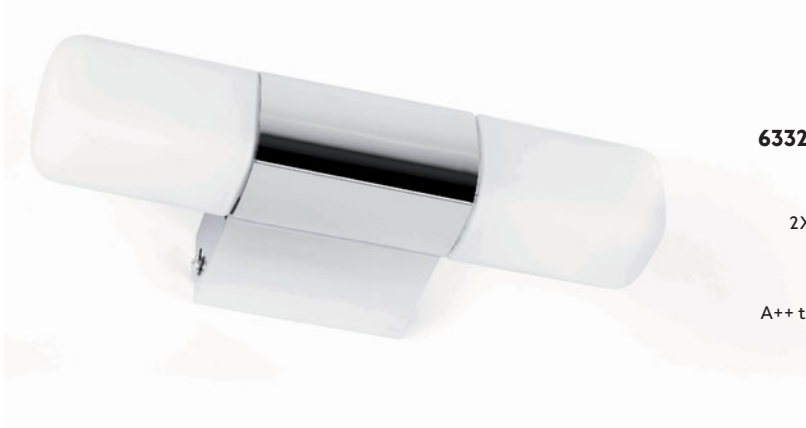

ikOn wall lamp

63325



2XG9 28W NOT INCL. [I5615] [LED I7440]

METAL + OPAL GLASS /
METAL + CRISTAL OPAL

A++ to E / 100-240V ~ 50-60 Hz / 0.72 kg / 1.59 lb

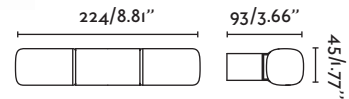

mild wall lamp

63326



1XG9 28W NOT INCL. [I5615] [LED I7440]

METAL + OPAL GLASS /
METAL + CRISTAL OPAL

A++ to E / 100-240V ~ 50-60 Hz / 0.39 kg / 0.86 lb

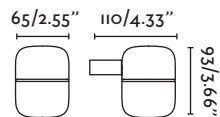



LED

[new] **sirEt**
wall lamp

64177



chrome
cromo

SMD LED 8W 2700K 600LM CRI>80 INCL.
DRIVER INCL.

ALUMINIUM + OPAL PMMA /
ALUMINIO + PMMA OPAL

A / 100-240V ~ 50-60 Hz / 1.06 kg / 2.34 lb



IP44

DRIVER

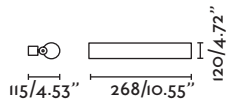

LED

[new] **sirEt**
wall lamp

64178



chrome
cromo

SMD LED 16W 2700K 1200LM CRI>80 INCL.
DRIVER INCL.

ALUMINIUM + OPAL PMMA /
ALUMINIO + PMMA OPAL

A / 100-240V ~ 50-60 Hz / 1.57 kg / 3.46 lb



IP44

DRIVER

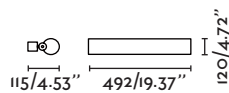

bathroom
baño
salle de bain
bagno

317



LED



tiMe wall lamp

63203

 matt nickel
níquel mate

HIGH POWER LED 6W 4000K 293LM INCL.
DRIVER INCL.

ALUMINIUM + TRANSLUCENT GLASS /
ALUMINIO + CRISTAL TRANSLÚCIDO

A++ / 220-240V ~ 50-60 Hz / 0.53 kg / 1.17 lb

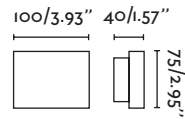

LED

caLda wall lamp

63147

 chrome
cromo

SMD LED 5W 4000K 400LM INCL.
DRIVER INCL.

ALUMINIUM + TRANSLUCENT POLYCARBONATE /
ALUMINIO + POLICARBONATO TRANSLÚCIDO

A+ / 100-240V ~ 50-60 Hz / 0.27 kg / 0.60 lb

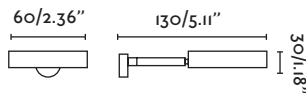

TO PLACE ON MIRROR
FIJACIÓN EN ESPEJO



5 MM



TO PLACE ON MIRROR
FIJACIÓN EN ESPEJO

5 MM

LED

teRma wall lamp

63148

 chrome
cromo

SMD LED 5W 4000K 400LM INCL.
EXTERNAL DRIVER INCL. / DRIVER EXTERNO INCL.

STEEL + ALUMINIUM + TRANSLUCENT PMMA /
ACERO + ALUMINIO + PMMA TRANSLÚCIDO

A++ to A / 100-240V ~ 50-60 Hz / 0.6 kg / 1.32 lb

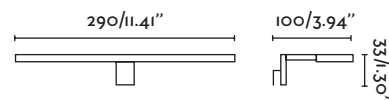

bathroom
baño
salle de bain
bagno





laoS wall lamp

63320



1XE14 40W NOT INCL. [15607] [LED 17450]

ALUMINIUM + OPAL GLASS /
ALUMINIO + CRISTAL OPAL

A++ to E / 100-240V ~ 50-60 Hz / 0.6 kg / 1.32 lb

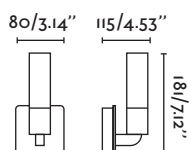

laoS wall lamp

63321



2XE14 40W NOT INCL. [15607] [LED 17450]

ALUMINIUM + OPAL GLASS /
ALUMINIO + CRISTAL OPAL

A++ to E / 100-240V ~ 50-60 Hz / 1 kg / 2.20 lb

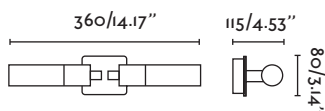



MIRROR LIGHTING

Illumination on both sides of the mirror reduces shadows and prevents glare.

La iluminación a ambos lados del espejo, reduce las sombras y evita deslumbramientos.

L'éclairage de chaque côté du miroir réduit les ombres et évite les éblouissements.



dokA wall lamp

63322



1 XE I4 28W NOT INCL. [15607] [LED 17450]

STEEL + OPAL GLASS /
ACERO + CRISTAL OPAL

A++ to E / 100-240V ~ 50-60 Hz / 0.9 kg / 1.98 lb

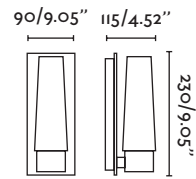

dokA wall lamp

63323



2 XE I4 28W NOT INCL. [15607] [LED 17450]

STEEL + OPAL GLASS /
ACERO + CRISTAL OPAL

A++ to E / 100-240V ~ 50-60 Hz / 1.3 kg / 2.87 lb

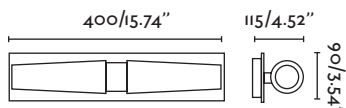

dokA ceiling lamp

63324



3 XE I4 28W NOT INCL. [15607] [LED 17450]

STEEL + OPAL GLASS /
ACERO + CRISTAL OPAL

A++ to E / 100-240V ~ 50-60 Hz / 1.3 kg / 2.87 lb

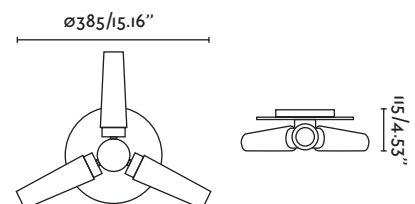



reLax wall lamp

63043



chrome
cromo

2XG9 MAX 28W NOT INCL. [15615] [LED 17440]

METAL + TRANSLUCENT GLASS /
METAL + CRISTAL TRANSLÚCIDO

A++ to E / 100-240V ~ 50-60 Hz / 0.5 kg / 1.10 lb

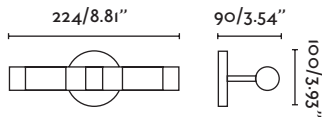

reLax wall lamp

63038



chrome
cromo

2XG9 28W NOT INCL. [15615] [LED 17440]

METAL + TRANSLUCENT GLASS /
METAL + CRISTAL TRANSLÚCIDO

A++ to B / 100-240V ~ 50-60 Hz / 0.49 kg / 1.08 lb

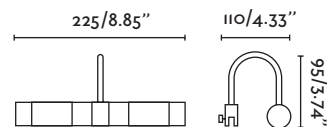

TO PLACE ON MIRROR
FIJACIÓN EN ESPEJO

nIger wall lamp

63120



matt nickel
níquel mate

2XE14 40W NOT INCL. [15607] [LED 17450]

ALUMINIUM + METAL + TRANSLUCENT GLASS /
ALUMINIO + METAL + CRISTAL TRANSLÚCIDO

A++ to E / 100-240V ~ 50-60 Hz / 0.75 kg / 1.65 lb

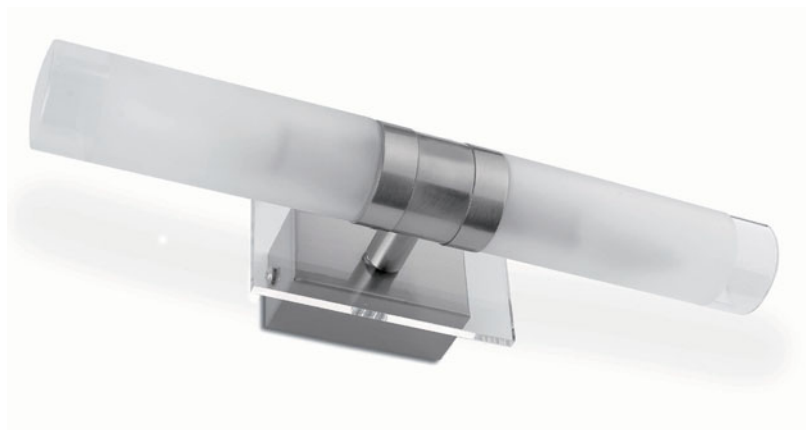
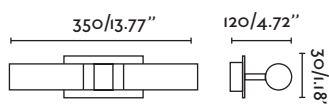

bathroom
baño
salle de bain
bagno

325





lAss wall lamp

63008  mirror
espejo

4XG9 25W NOT INCL. [I5615] [LED I7440]

METAL + GLASS /
METAL + CRISTAL

A++ to B / 100-240V ~ 50-60 Hz / 1.69 kg / 3.73 lb

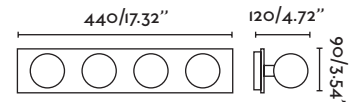

lAss wall lamp

63009  mirror
espejo

5XG9 25W NOT INCL. [I5615] [LED I7440]

METAL + GLASS /
METAL + CRISTAL

A++ to B / 100-240V ~ 50-60 Hz / 2.3 kg / 5.07 lb

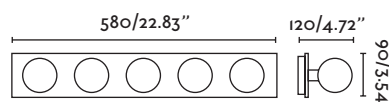

LED

iNdo wall lamp

63146  chrome
cromo

SMD LED 9W 4000K 600LM INCL.
DRIVER INCL.

METAL + ALUMINIUM + OPAL PMMA /
METAL + ALUMINIO + PMMA OPAL

A / 100-240V ~ 50-60 Hz / 1.07 kg / 2.36 lb

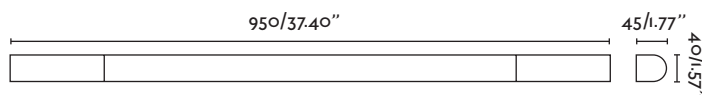



[new] **clOe**
ceiling lamp

63403



chrome
cromo

SMD LED 24W 2700K 2000LM CRI>80 INCL.
DRIVER INCL.

METAL + OPAL GLASS /
METAL + CRISTAL OPAL

A+ / 100-240V ~ 50-60 Hz / 1.24 kg / 2.73 lb



IP44

DRIVER

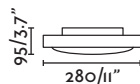
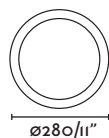



[new] **KaO**
ceiling lamp

63399

chrome
cromo

SMD LED 35W 3000K 2800LM INCL.
DRIVER INCL.

METAL + OPAL PMMA /
METAL + PMMA OPAL

A+ / 100-240V ~ 50-60 Hz / 1.02 kg / 2.25 lb



ø430/16.93"

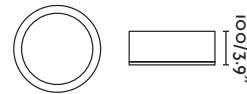

LED

yUca
ceiling lamp

63401

matt nickel
níquel mate

OUT OF CATALOGUE
DESCATALOGADO

SMD LED 11W 4000K 635LM INCL.
DRIVER INCL.

ALUMINIUM + OPAL GLASS /
ALUMINIO + CRISTAL OPAL

A++ / 220-240V ~ 50-60 Hz / 1.4 kg / 3.09 lb

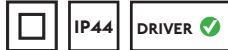

ø310/12.20"

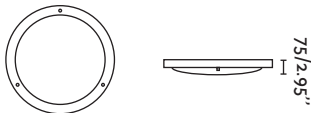

clEan
ceiling lamp

OUT OF CATALOGUE
DESCATALOGADO

63039

chrome
cromo

1XE27 MAX 60W NOT INCL. [16167] [LED 17453]

METAL + OPAL GLASS /
METAL + CRISTAL OPAL

A++ to E / 100-240V ~ 50-60 Hz / 1.99 kg / 4.39 lb



ø300/11.81"

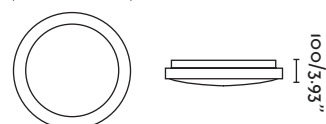

bathroom
baño
salle de bain
bagno



cOra
ceiling lamp

63007



chrome+white
cromo+blanco

1 X E27 60W NOT INCL. [16293] [LED 17452]

ALUMINIUM + METAL + OPAL GLASS /
ALUMINIO + METAL + CRISTAL OPAL

A++ to E / 100-240V ~ 50-60 Hz / 1.3 kg / 2.87 lb



IP44

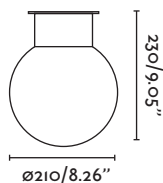



bOden ceiling lamp

63302C

polished aluminium
aluminio pulido

1XT5 G10q 22W 4200K [15850] INCL.
GEAR INCL.

ALUMINIUM + OPAL ACRYLIC /
ALUMINIO + ACRÍLICO OPAL

A to B / 220-240V ~ 50-60 Hz / 0.7 kg / 1.54 lb

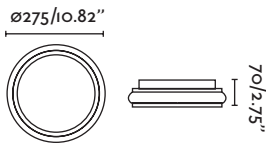

bOden ceiling lamp

63303C

polished aluminium
aluminio pulido

1XT5 G10q 32W 4200K [15850] INCL.
GEAR INCL.

ALUMINIUM + OPAL ACRYLIC /
ALUMINIO + ACRÍLICO OPAL

A to B / 220-240V ~ 50-60 Hz / 1.1 kg / 2.43 lb

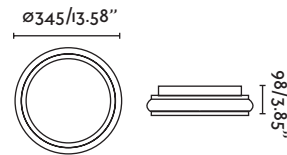

bOden ceiling lamp

OUT OF CATALOGUE
DESCATALOGADO

63304C

polished aluminium
aluminio pulido

1XT5 G10q 40W 4200K INCL.
GEAR INCL.

ALUMINIUM + OPAL ACRYLIC /
ALUMINIO + ACRÍLICO OPAL

A to B / 220-240V ~ 50-60 Hz / 1.4 kg / 3.09 lb

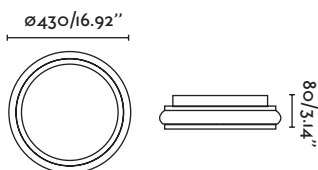





LoGos ceiling lamp

62965  white
blanco

62980  polished aluminium
aluminio pulido

1 XE27 20W NOT INCL. [16467] [LED 17453]

ALUMINIUM + OPAL POLYCARBONATE /
ALUMINIO + POLICARBONATO OPAL

A++ to B / 100-240V ~ 50-60 Hz / 1 kg / 2.20 lb



ø270/10.62"

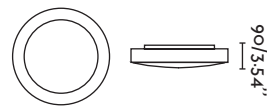

LoGos ceiling lamp

62966  white
blanco

62981  polished aluminium
aluminio pulido

2 XE27 20W NOT INCL. [16467] [LED 17453]

ACRYLIC + OPAL POLYCARBONATE /
ACRÍLICO + POLICARBONATO OPAL

A++ to B / 100-240V ~ 50-60 Hz / 1.5 kg / 3.31 lb



ø350/13.77"

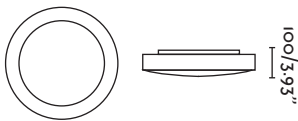

LoGos ceiling lamp

62982  polished aluminium
aluminio pulido

3 XE27 20W NOT INCL. [16467] [LED 17453]

ACRYLIC + OPAL POLYCARBONATE /
ACRÍLICO + POLICARBONATO OPAL

A++ to B / 100-240V ~ 50-60 Hz / 1.7 kg / 3.75 lb



ø410/16.14"

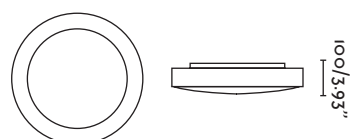





tOla ceiling lamp

62968  white
blanco

62983  polished aluminium
aluminio pulido

1XE27 20W NOT INCL. [16467] [LED 17453]

ALUMINIUM + OPAL POLYCARBONATE /
ALUMINIO + POLICARBONATO OPAL

A++ to B / 100-240V ~ 50-60 Hz / 1.3 kg / 2.87 lb

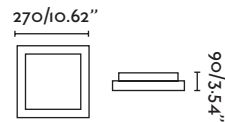

tOla ceiling lamp

62969  white
blanco

62984  polished aluminium
aluminio pulido

2XE27 20W NOT INCL. [16467] [LED 17453]

ALUMINIUM + OPAL POLYCARBONATE /
ALUMINIO + POLICARBONATO OPAL

A++ to B / 100-240V ~ 50-60 Hz / 1.6 kg / 3.53 lb

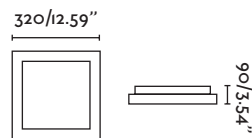

tOla ceiling lamp

62985  polished aluminium
aluminio pulido

3XE27 20W NOT INCL. [16467] [LED 17453]

ALUMINIUM + OPAL POLYCARBONATE /
ALUMINIO + POLICARBONATO OPAL

A++ to B / 100-240V ~ 50-60 Hz / 2.3 kg / 5.07 lb

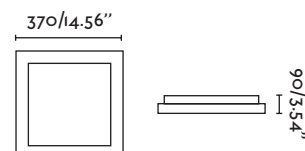



[new] **tEd**
recessed

42926



white
blanco

SMD LED 15W 3000K 1500LM INCL.
DRIVER INCL.

ALUMINIUM + PMMA /
ALUMINIO + PMMA

A+ / 220-240V ~ 50-60 Hz / 0.28 kg / 0.62 lb

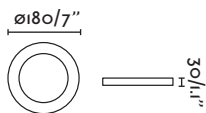

[new] **tOd**
recessed

42927



white
blanco

SMD LED 24W 3000K 2400LM INCL.
DRIVER INCL.

ALUMINIUM + PMMA /
ALUMINIO + PMMA

A+ / 220-240V ~ 50-60 Hz / 0.41 kg / 0.90 lb

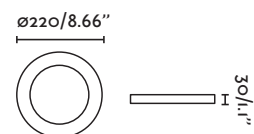



LED



eBba recessed

42919



translucent+silver
translúcido+plata

SMD LED 4W 3000K 304LM INCL.
DRIVER INCL.

ALUMINIUM + TRANSPARENT PMMA + OPAL PMMA /
ALUMINIO + PMMA TRANSPARENTE + PMMA OPAL

A++ / 100-240V ~ 50-60 Hz / 0.3 kg / 0.66 lb



ø70/2.75"

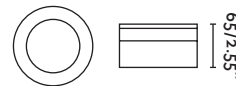

LED

PACK 3 UTS



baTh-3 recessed (pack)

42918

white
blanco

SMD LED 3W 5000K 210LM INCL.
DRIVER DC 9.5V INCL.

ALUMINIUM + OPAL PMMA /
ALUMINIO + PMMA OPAL

A / 220-240V ~ 50-60 Hz / 0.42 kg / 0.93 lb



ø85/3.35"

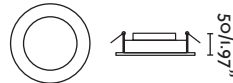

LED

naRa recessed

42922

white
blanco

SMD LED 20W 3000K 1500LM INCL.
DRIVER INCL.

ALUMINIUM + OPAL POLYCARBONATE /
ALUMINIO + POLICARBONATO OPAL

A++ / 100-240V ~ 50-60 Hz / 0.8 kg / 1.76 lb



ø183/7.20"

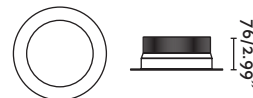

bathroom
baño
salle de bain
bagno

339



BATHROOM

For your bathroom ceiling installing embedded lights will be enough to achieve consistent lighting.

Para el techo de tu baño instalar empotrables será suficiente para conseguir una luz uniforme.

Pour le plafond de votre salle de bains, installer des lampes encastrables sera suffisant pour obtenir une lumière uniforme.

LED



danA recessed

42925  white
blanco

SMD LED 12W 5000K 900LM INCL.
DRIVER INCL.

ALUMINIUM + OPAL PMMA /
ALUMINIO + PMMA OPAL

A++ to A / 100-240V ~ 50-60 Hz / 0.3 kg / 0.66 lb



ø90/3.54"

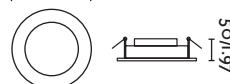

quaSar recessed

OUT OF CATALOGUE
DESCATALOGADO

42905  matt nickel
níquel mate

1 XMR I6 50W NOT INCL. [LED 14142]
GEAR NOT INCL. [43070]. LED [98101050]

METAL /
METAL

A++ to E / 220-240V ~ 50-60 Hz / 0.25 kg / 0.55 lb



85/3.35"



IP65

kanT recessed

40215  grey
gris

40225  white
blanco

1 XMR I6 50W NOT INCL. [LED 14142]
GEAR NOT INCL. [43070]. LED [98101050]

DIE CAST ALUMINIUM + TRANSLUCENT GLASS /
ALUMINIO INYECTADO + CRISTAL TRANSLÚCIDO

A++ to E / 12V ~ 0.19 kg / 0.42 lb



ø80/3.15"



bathroom
baño
salle de bain
bagno



eVa recessed

42972



mirror
espejo

HF

2XE27 MAX 13W NOT INCL. [I6467]

METAL + GLASS /
METAL + CRISTAL

C to E / 100-240V ~ 50-60 Hz / 1.2 kg / 2.65 lb



165/6.50"

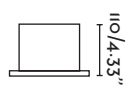

110/4.33"

eVa recessed

42973



HF

2XE27 23W NOT INCL. [16464]

METAL + GLASS /
METAL + CRISTAL

C to E / 100-240V ~ 50-60 Hz / 1.9 kg / 4.19 lb

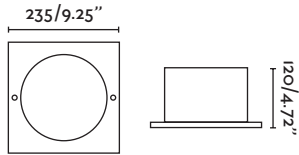

eVa recessed

42970



HF

2XE27 MAX 13W NOT INCL. [16467]

METAL + GLASS /
METAL + CRISTAL

C to E / 100-240V ~ 50-60 Hz / 1.1 kg / 2.43 lb

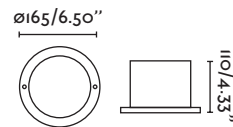

eVa recessed

42971



HF

2XE27 23W NOT INCL. [16464]





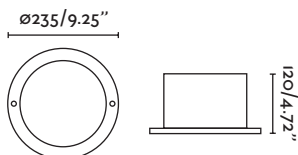

























METAL + GLASS /
METAL + CRISTAL

C to E / 100-240V ~ 50-60 Hz / 1.5 kg / 3.31 lb



office

oficina y estudio/bureau/ufficio

 aladiNo	360	 maGni	372
 anoUk	351	 mAket	372
 aRiel	361	 meRlín	369
 baBá	357	 mulAn	365
 baObab	359	 nioBe	370
 bOb	365	 nuKa [new]	364
 elbA	363	 oNa	351
 gaLileo	370	 oTto [new]	353
 gRu	359	 riMa	353
 hAlo	349	 Sam	369
 lásEr	371	 sElene	366
 Lea	373	 sWan	347
 lenA	355	 teR	368
 leNte	371	 yAp	357
 lEo	363	 yeTi	362
 liLY	369		





OFFICE

office
oficina y estudio
bureau
ufficio







MADE IN JAPAN
HECHO EN JAPON

DIMMABLE
DIMABLE

sWan desk lamp

55204



black
negro

SMD LED 6.4W 2700-6300K 530LM INCL.
DRIVER INCL.

METAL + ALUMINIUM + POLYCARBONATE /
METAL + ALUMINIO + POLICARBONATO

A / 220-240V ~ 50-60 Hz / 4.5 kg / 9.92 lb

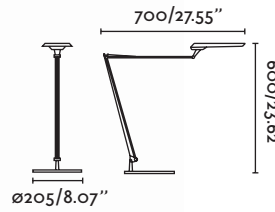

DIFFERENT LIGHT TEMPERATURES
DIFERENTES TEMPERATURAS LUZ



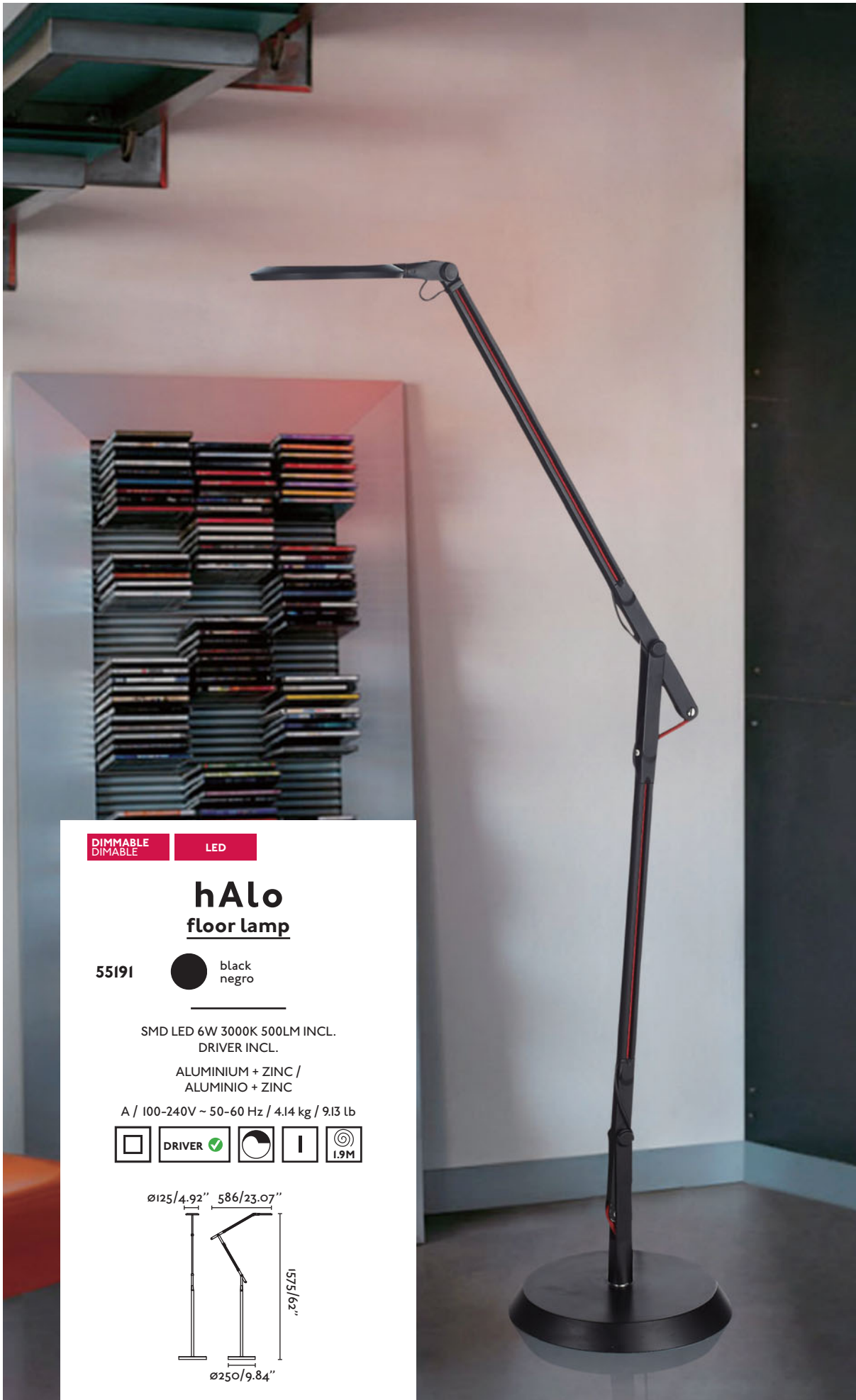

DIMMABLE
DIMABLE

LED

hAlo floor lamp

55191



black
negro

SMD LED 6W 3000K 500LM INCL.
DRIVER INCL.

ALUMINIUM + ZINC /
ALUMINIO + ZINC

A / 100-240V ~ 50-60 Hz / 4.14 kg / 9.13 lb



DRIVER 



1.9M

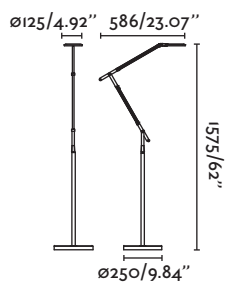



DIMMABLE
DIMABLE

LED

hAlo table lamp

55190

black
negro

SMD LED 6W 3000K 500LM INCL.
DRIVER INCL.

ALUMINIUM + ZINC /
ALUMINIO + ZINC

A / 100-240V ~ 50-60 Hz / 3.83 kg / 8.44 lb

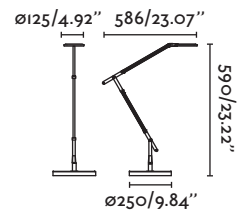

WITH SWITCH
CON INTERRUPTOR



CLIP ACCESSORY /
ACCESORIO PINZA

55193

NOT INCL.
0.21 kg / 0.46 lb

BASE TO BECOME WALL LAMP
/ BASE PARA CONVERTIRLA EN
APLIQUE

55192

NOT INCL.
0.17 kg / 0.37 lb







DIMMABLE
DIMABLE

TOUCH LAMP
LAMPARA TACTIL

[new] **anoUk**
desk lamp

53414  white
blanco

53415  black
negro

SMD LED 8W 4000K 530LM INCL.
DRIVER INCL.

ABS /
ABS

A++ / 100-240V ~ 50-60 Hz / 1.09 kg / 2.40 lb

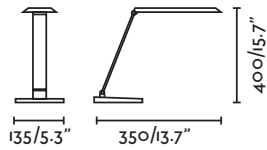

DIMMABLE
DIMABLE

TOUCH SENSOR 3 INTENSITIES
SENSOR TACTIL 3 INTENSIDADES

[new] **oNa**
desk lamp

52081  white
blanco

SMD LED 5W 5000-5600K 300LM INCL.
DRIVER INCL.

ABS /
ABS

A / 100-240V ~ 50-60 Hz / 0.77 kg / 1.70 lb

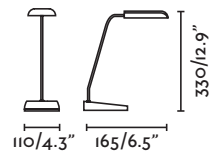





DIMMABLE
DIMABLE

LED

TOUCH SENSOR 3 INTENSITIES
SENSOR TÁCTIL 3 INTENSIDADES

riMa desk lamp

50992



white
blanco

HF

50993



black
negro

HF

SMD LED 6W 5600K 320LM CRI≥80 INCL.
ELECTRONIC ADAPTATEUR 10.5V 660MA INCL.

ALUMINIUM + POLYCARBONATE /
ALUMINIO + POLICARBONATO

A++ to E / 220-240V ~ 50-60 Hz / 1.2 kg / 2.65 lb



HF Until stock exhaustion
Hasta final de stock
Jusqu'à la fin de stock

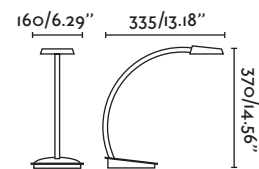

LED

TOUCH SENSOR 3 INTENSITIES
SENSOR TÁCTIL 3 INTENSIDADES

[new] oTto desk lamp

52064



black
negro

52065



white
blanco

SMD LED 6W 4000K 550LM INCL.
DRIVER INCL.

METAL + POLYCARBONATE /
METAL + POLICARBONATO

100-240V ~ 50-60 Hz / 1.29 kg / 2.84 lb

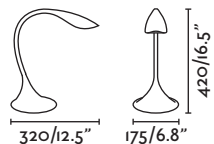



LED

[new] lenA clip

52059  white
blanco

52061  black
negro

SMD LED 3W 4000K 300LM INCL.
DRIVER INCL.

ALUMINIUM + METAL + SILICONE /
ALUMINIO + METAL + SILICONA

A++ / 220-240V ~ 50-60 Hz / 0.55 kg / 1.21 lb

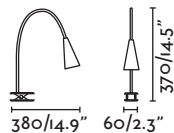

DIMMABLE
DIMABLE

LED

TOUCH SENSOR 3 INTENSITIES
SENSOR TÁCTIL 3 INTENSIDADES

lenA desk lamp

52057  white
blanco

52058  black
negro

SMD LED 3W 4000K 300LM INCL.
ELECTRONIC ADAPTATEUR 10.5V 660MA INCL.

ALUMINIUM + POLYCARBONATE + GLASS + SILICONE /
ALUMINIO + POLICARBONATO + CRISTAL + SILICONA

A++ / 220-240V ~ 50-60 Hz / 1.5 kg / 3.31 lb

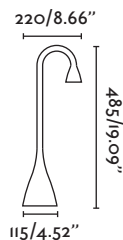



PLUG & PLAY USB ADAPTER
ENCHUFE Y ADAPTADOR USB

LED



baBá table lamp

51973  white
blanco

51975  grey
gris

SMD LED 2,4W 6000K 180LM INCL.
DRIVER INCL.

ALUMINIUM + ABS /
ALUMINIO + ABS

A++ / 220-240V ~ 50-60 Hz / 0.78 kg / 1.72 lb

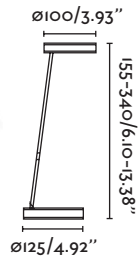

LED

yAp table lamp

55018  white
blanco

OUT OF CATALOGUE
DESCATALOGADO

55019  black
negro

SMD LED 7W 3000K 550LM INCL.
DRIVER INCL.

ALUMINIUM /
ALUMINIO

A+ / 100-240V ~ 50-60 Hz / 2 kg / 4.41 lb

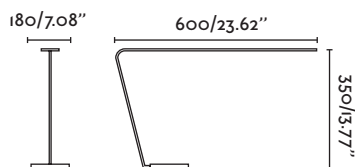



office
oficina y estudio
bureau
ufficio

357





baObab desk lamp

- 51908  white
blanco
- 51909  black
negro
- 51910  grey
gris
- 51911  pistachio green
verde pistacho



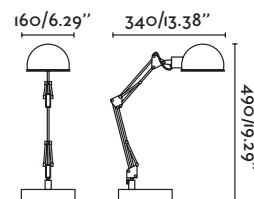

1XE14 IIW NOT INCL. [16321] [LED 17057]

METAL /
METAL

A++ to B / 100-240V ~ 50-60 Hz / 1.6 kg / 3.53 lb



gRu desk lamp

- 51916  white
blanco
- 51917  black
negro
- 51918  yellow
amarillo
- 51919  red
rojo

1XE27 IIW NOT INCL. [16320] [LED 17452]

METAL /
METAL

A++ to B / 100-240V ~ 50-60 Hz / 1.49 kg / 3.28 lb

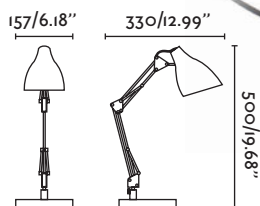

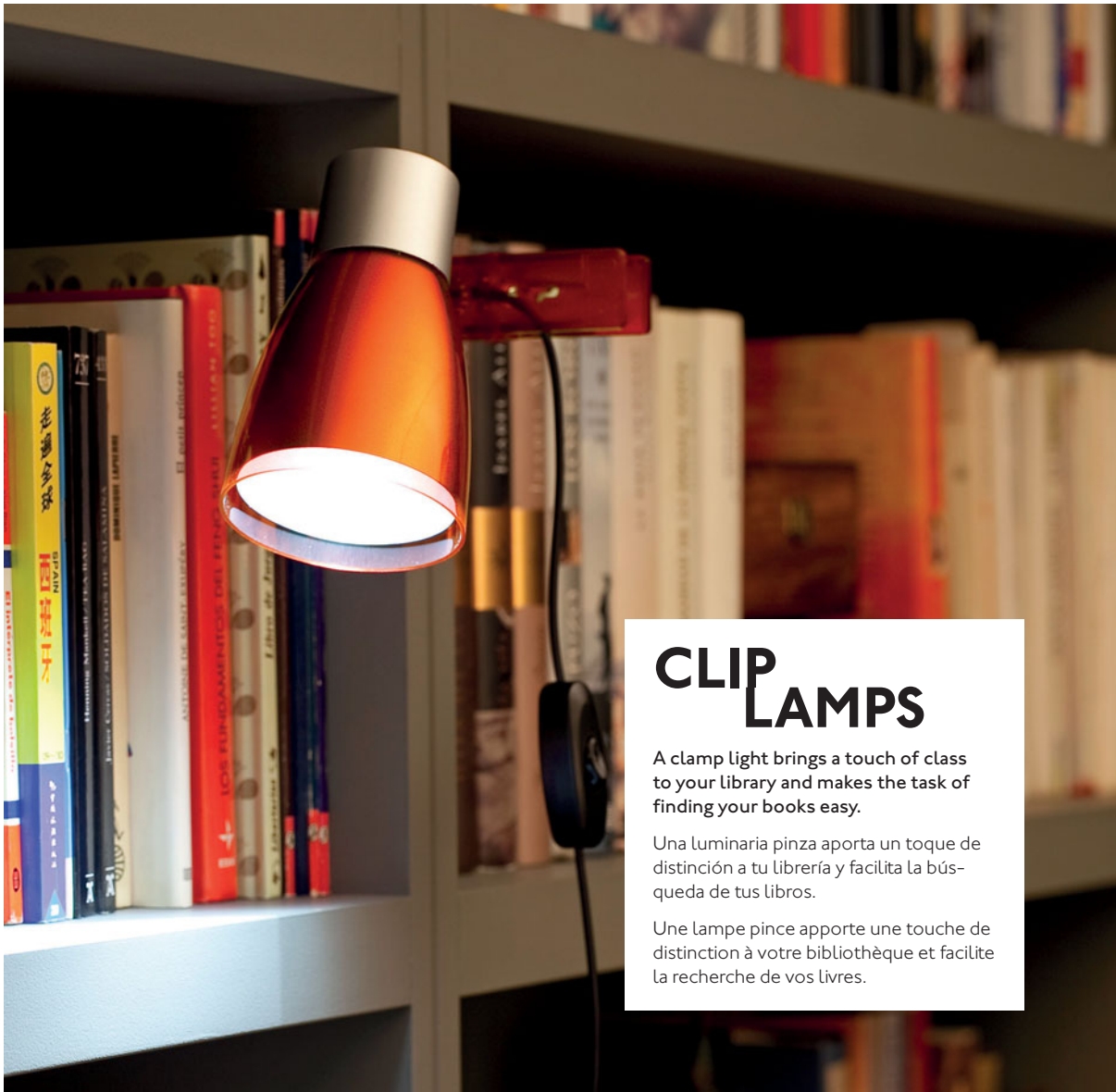

CLIP LAMPS

A clamp light brings a touch of class to your library and makes the task of finding your books easy.

Una luminaria pinza aporta un toque de distinción a tu librería y facilita la búsqueda de tus libros.

Une lampe pince apporte une touche de distinction à votre bibliothèque et facilite la recherche de vos livres.

LED

aladiNo clip

OUT OF CATALOGUE
DESCATALOGADO

51960



grey
gris

HF

OUT OF CATALOGUE
DESCATALOGADO

51961



electric blue
azul eléctrico

HF

51962



black
negro

HF

51964



pure green
verde vivo

HF

51965



orange
naranja

HF

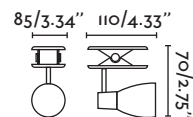

HIGH POWER LED 3W 6400K 200LM INCL.
DRIVER INCL.

POLYCARBONATE + ABS /
POLICARBONATO + ABS

A++ / 220-240V ~ 50-60 Hz / 0.4 kg / 0.88 lb



DRIVER ✓



HF

Until stock exhaustion
Hasta final de stock
Jusqu'à la fin de stock



LED

aladiNo desk lamp

- 51966  grey / gris HF
- 51967  electric blue / azul eléctrico HF
- 51968  black / negro HF
- 51969  red / rojo HF
- 51970  pure green / verde vivo HF
- 51971  orange / naranja HF

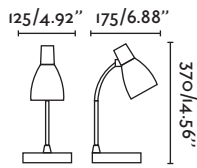

HIGH POWER LED 3W 6400K 200LM INCL.
DRIVER INCL.



POLYCARBONATE + ABS /
POLICARBONATO + ABS

A++ / 220-240V ~ 50-60 Hz / 0.8 kg / 1.76 lb



HF Until stock exhaustion
Hasta final de stock
Jusqu'à la fin de stock

aRiel desk lamp

- 51913  black / negro
- 51914  grey / gris
- 51915  red / rojo

1 X E14 11W NOT INCL. [16321] [LED 17057]

PVC /
PVC

A++ to B / 100-240V ~ 50-60 Hz / 1.4 kg / 3.09 lb

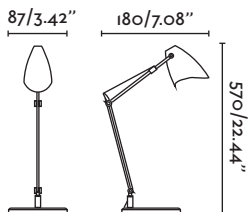



yeTi desk lamp

50994



white
blanco

1 X E27 15W NOT INCL. [16466] [LED 17452]

PVC /
PVC

A++ to B / 100-240V ~ 50-60 Hz / 1.49 kg / 3.28 lb

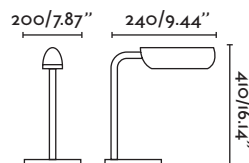



e**l**bA desk lamp

53413



black
negro

1 X E27 20W NOT INCL. [16467] [LED 17452]

ALUMINIUM + PVC /
ALUMINIO + PVC

A to B / 100-240V ~ 50-60 Hz / 1.7 kg / 3.75 lb

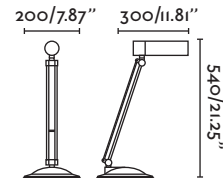

l**E**o desk lamp

52049



black
negro

1 X E27 15W NOT INCL. [16219] [LED 17452]

ALUMINIUM + POLYCARBONATE /
ALUMINIO + POLICARBONATO

A++ to B / 100-240V ~ 50-60 Hz / 1.6 kg / 3.53 lb

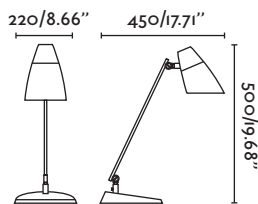

[new] **nuKa**
desk lamp

- 54009  red
rojo
- 54010  electric blue
azul eléctrico
- 54011  pure green
verde vivo

LED 3W 90LM 3000K INCL.
DRIVER INCL.

POLYCARBONATE + METAL /
POLICARBONATO + METAL

100-240V ~ 50-60 Hz / 0.4 kg / 0.88 lb

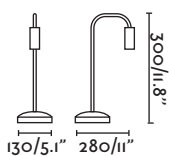

[new] **nuKa**
clip

- 54006  red
rojo
- 54007  electric blue
azul eléctrico
- 54008  pure green
verde vivo

LED 3W 90LM 3000K INCL.
DRIVER INCL.

POLYCARBONATE + METAL /
POLICARBONATO + METAL

100-240V ~ 50-60 Hz / 0.69 kg / 1.52 lb

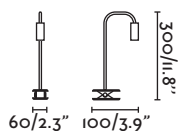



bOb desk lamp

- 52043  orange
naranja
- 52044  pale green
verde pastel
- 52045  sky blue
azul celeste
- 52046  pink
rosa

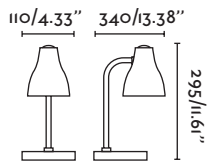



1 XE27 MAX 15W NOT INCL. [16322] [LED 17452]

ABS /
ABS

A++ to B / 100-240V ~ 50-60 Hz / 0.88 kg / 1.94 lb



mulAn desk lamp

- 51900  white
blanco
- 51901  black
negro
- 51902  purple
lila

1 XE27 MAX 11W NOT INCL. [16320] [LED 17452]

METAL /
METAL

A++ to B / 100-240V ~ 50-60 Hz / 1.49 kg / 3.28 lb

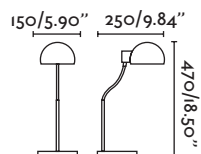



sElene desk lamp

- 51170  pure green
verde vivo
- 51171  orange
naranja
- 51172  yellow
amarillo

1 XE27 15W NOT INCL. [I6292] [LED I7452]

ALUMINIUM + PVC /
ALUMINIO + PVC

A++ to B / 100-240V ~ 50-60 Hz / 0.8 kg / 1.76 lb

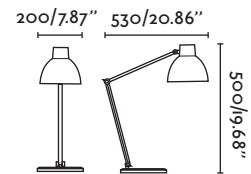

sElene desk lamp

- 51162  yellow
amarillo
- 51164  black
negro

1 XE27 15W NOT INCL. [I6292] [LED I7452]

ALUMINIUM + PVC /
ALUMINIO + PVC

A++ to B / 100-240V ~ 50-60 Hz / 2.8 kg / 6.17 lb

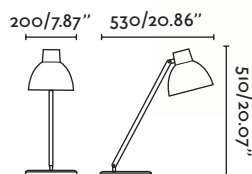



OUT OF CATALOGUE
DESCATALOGADO

OUT OF CATALOGUE
DESCATALOGADO

sElene wall lamp

- 51180  pure green
verde vivo
- 51181  orange
naranja
- 51182  yellow
amarillo
- 51184  black
negro

1XE27 15W NOT INCL. [16292] [LED 17452]
ALUMINIUM + PVC /
ALUMINIO + PVC

A++ to B / 100-240V ~ 50-60 Hz / 1 kg / 2.20 lb

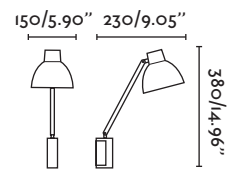

CLIP AND WALL ACCESSORY /
ACCESORIO PINZA Y PARED

51179

INCL.
0.2 kg / 0.44 lb



teR clip

51151



grey
gris

1 XE14 MAX 15W NOT INCL. [I16621] [LED I7057]

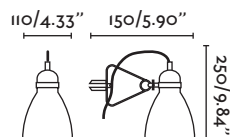

METAL /
METAL

A++ to B / 100-240V ~ 50-60 Hz / 0.5 kg / 1.10 lb





Sam desk lamp

- 52006  white
blanco
- 52008  black
negro
- 52009  red
rojo

1XE27 MAX 40W NOT INCL. [16322] [LED 17452]

METAL /
METAL

A++ to E / 100-240V ~ 50-60 Hz / 0.9 kg / 1.98 lb

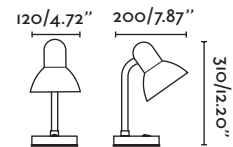

lily clip

OUT OF CATALOGUE
DESCATALOGADO

40010  white
blanco

HF

40011  black
negro

HF

1XR50 E14 25W NOT INCL. [16600]

METAL /
METAL

A+++ to B / 100-240V ~ 50-60 Hz / 0.6 kg / 1.32 lb

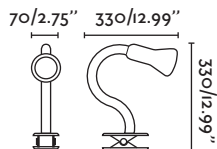

meRlín clip

51904  black
negro

OUT OF CATALOGUE
DESCATALOGADO

51905  electric blue
azul eléctrico

OUT OF CATALOGUE
DESCATALOGADO

1XE14 MAX 25W NOT INCL. [16237] [LED 17451]

PVC /
PVC

A++ to B / 100-240V ~ 50-60 Hz / 0.38 kg / 0.84 lb

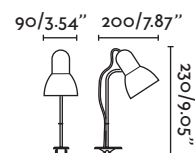

HF
Until stock exhaustion
Hasta final de stock
Jusqu'à la fin de stock

nioBe desk lamp

51089



OUT OF CATALOGUE
DESCATALOGADO

1 XPL GY 10q 27W 4500K INCL.

PVC /
PVC

A to B / 220-240V ~ 50-60 Hz / 2.1 kg / 4.63 lb

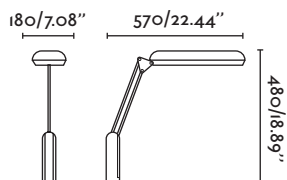

HF Until stock exhaustion
Hasta final de stock
Jusqu'à la fin de stock



gaLileo desk lamp

52076



OUT OF CATALOGUE
DESCATALOGADO

1 XGX 10q 24W 4500K INCL.

PVC /
PVC

A to B / 220-240V ~ 50-60 Hz / 1.45 kg / 3.20 lb

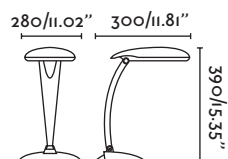



lásEr desk lamp

51011

● black
negro

1 XPL G23q 11W 6400K INCL.

METAL + PVC /
METAL + PVC

A to B / 220-240V ~ 50-60 Hz / 2.4 kg / 5.29 lb

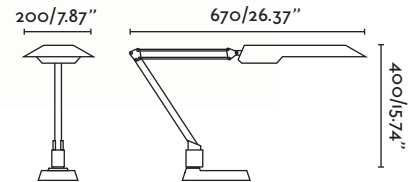

leNte desk lamp

50064

● black
negro

1 XG10q T4 12W INCL.
GEAR INCL.

PVC + GLASS /
PVC + CRISTAL

A to B / 220-240V ~ 50-60 Hz / 1.2 kg / 2.65 lb

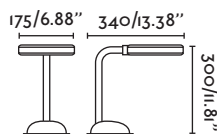

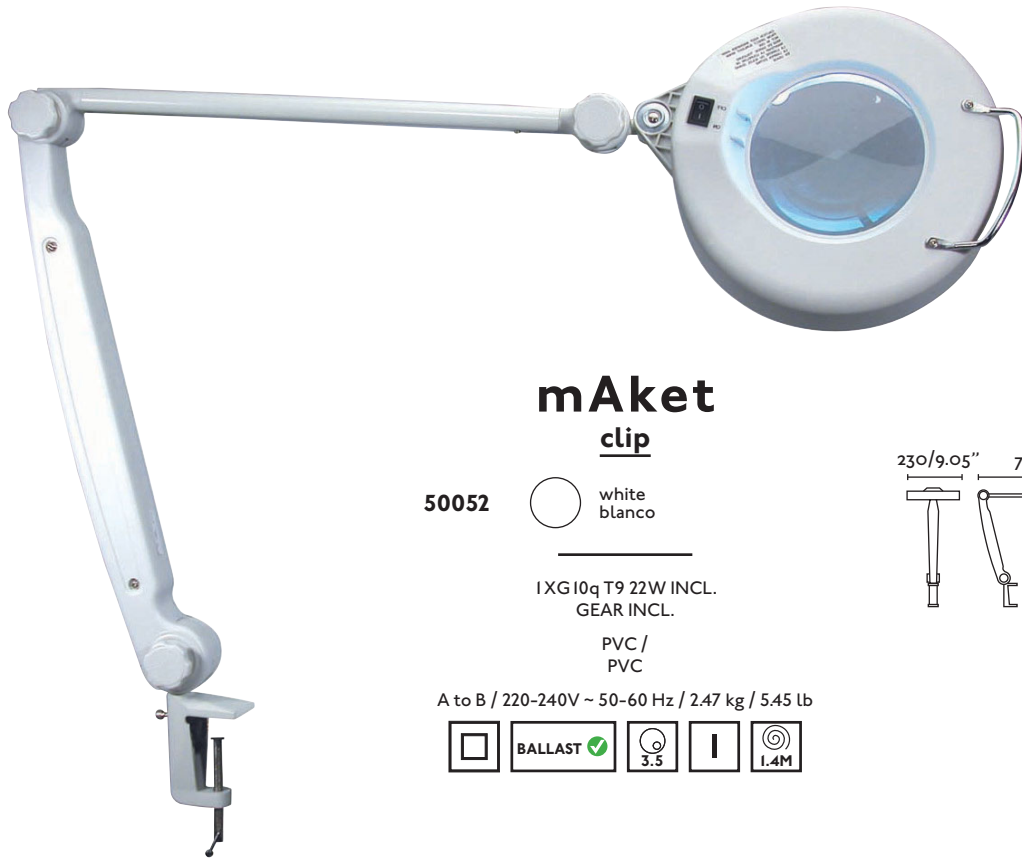

mAket clip

50052



white
blanco

1 XG10q T9 22W INCL.
GEAR INCL.

PVC /
PVC

A to B / 220-240V ~ 50-60 Hz / 2.47 kg / 5.45 lb

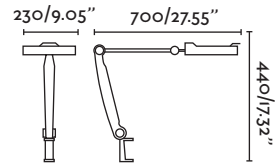

maGni clip

50040



white
blanco

50041



black
negro

1 XG10q T9 22W INCL.
GEAR INCL.

METAL /
METAL

A++ to E / 220-240V ~ 50-60 Hz / 2.5 kg / 5.51 lb

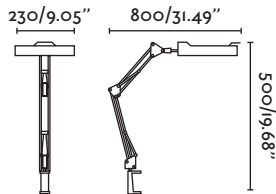

MAGNI LENS / CRISTAL MAGNI

50042

NOT INCL.
GLASS /
CRISTAL

0.42 kg / 0.93 lb



MAGNI AND LEA BASE ACCESSORY
/ ACCESORIO PIE MAGNI Y LEA

50043

NOT INCL.
METAL /
METAL

5.1 kg / 11.24 lb

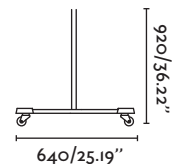



LED

Lea clip

50025



white
blanco

SMD LED 10W 4000K 616LM CRI≥81 INCL.

METAL + GLASS /
METAL + CRISTAL

A++ / 100-240V ~ 60 Hz / 1.35 kg / 2.98 lb

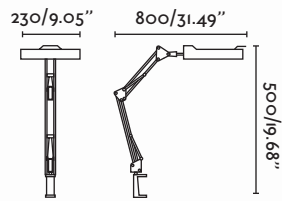

MAGNI AND LEA BASE ACCESSORY
/ ACCESORIO PIE MAGNI Y LEA

50043

NOT INCL.





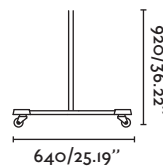

METAL /
METAL

5.1 kg / 11.24 lb



special luminaires

Luminarias especiales/autres/lampade speciali

	blisTer ledStrip	376
	caBi	379
	cLon	378
	flUo	380
	laMpi	380
	ledStrip	376
	uNit [new]	379



VARIOUS



special luminaires
luminarias especiales
autres
lampade speciali





blisTer ledStrip

19026 2700-3000K HF

LED 4,8W INCL.
DRIVER INCL.

PCB /
PCB

A++ to B / 220-240V ~ 50-60 Hz / 0.19 kg / 0.42 lb



19027 2700-3000K HF

LED 9,6W INCL.
DRIVER INCL.

PCB /
PCB

A++ to B / 220-240V ~ 50-60 Hz / 0.22 kg / 0.49 lb



HF
Until stock exhaustion
Hasta final de stock
Jusqu'à la fin de stock

ledStrip

[new] **19028**  warm white
blanco cálido 3000K 1350Lm

[new] **19029**  cold white
blanco frío 5000K 1550Lm

LED 36W 12VDC
DRIVER NOT INCL. [19031]

PCB/
PCB

A++ to B / 220-240V ~ 50-60 Hz / 0.35 kg / 0.77 lb



30 LED/MT

[new] **19030**  RGB
RGB

LED 36W 24VDC RGB
DRIVER NOT INCL. [19031]

PCB/
PCB

A++ to B / 220-240V ~ 50-60 Hz / 0.35 kg / 0.77 lb



30 LED/MT



POWER SUPPLY /
FUENTE DE ALIMENTACIÓN

19031

100-240 V AC 36W 3A 24V DC

A++ to B / 220-240V ~ 50-60 Hz / 0.38 kg / 0.84 lb



CONNECTOR WITH CABLE /
CONECTOR CON CABLE

19036

monocolour
monocolor

19037



RGB
RGB



CONNECTOR / CONECTOR

19038

monocolour
monocolor

19039



RGB
RGB



REMOTE CONTROL /
MANDO A DISTANCIA

19032



rgb
rgb

A++ to B / 220-240V ~ 50-60 Hz / 0.07 kg / 0.15 lb



CONNECTOR WITH JACK /
CONECTOR CON JACK

19034

monocolour
monocolor

19035



RGB
RGB



All LED accessories are easy to connect.

Los accesorios para las tiras LED de interior y exterior se unen fácilmente gracias a sus interconectores.

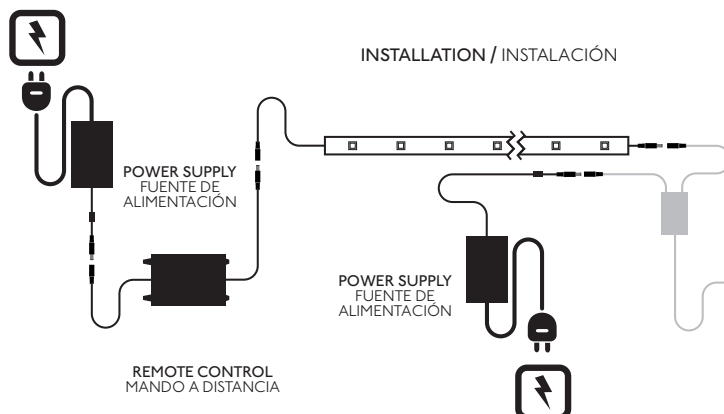

Accessories and driver not included.
Equipo y accesorios no incluidos.



KITCHENS

The sink area (water area) of your kitchen may require an additional point of light.

La zona del fregadero (zona de aguas) de tu cocina puede requerir un punto de luz adicional.

La zone de l'évier de votre cuisine peut demander un point de lumière supplémentaire.



cLon

62083  grey / gris HF

1XT5 8W 6400K INCL.
GEAR INCL.

METAL + PVC /
METAL + PVC

A to B / 220-240V ~ 50-60 Hz / 0.5 kg / 1.10 lb

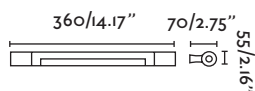

HF **Until stock exhaustion**
Hasta final de stock
Jusqu'à la fin de stock



[new] **uNit**

62086  white
blanco

LED 4W 4000K 300LM INCL.

PVC /
PVC

100-240V ~ 50 Hz / 0.1 kg / 0.22 Lb

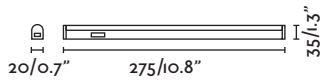

[new] **uNit**

62087  white
blanco

LED 9W 4000K 720LM 180° CRI>80 INCL.

PVC /
PVC

100-240V ~ 50-60 Hz / 0.15 kg / 0.33 Lb

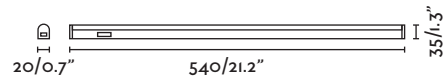

caBi

62056  white
blanco

HF

1 XT5 13W INCL.
GEAR INCL.

PVC /
PVC

A to B / 220-240V ~ 50-60 Hz / 0.71 kg / 1.57 Lb

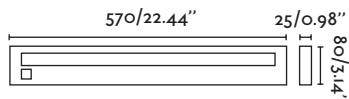

caBi

62055  white
blanco

HF

1 XT5 8W INCL.
GEAR INCL.

PVC /
PVC

A to B / 220-240V ~ 50-60 Hz / 0.5 kg / 1.10 Lb

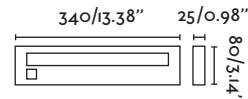

HF
Until stock exhaustion
Hasta final de stock
Jusqu'à la fin de stock



flUo

62061



white
blanco

HF

62063



white
blanco

OUT OF CATALOGUE
DESCATALOGADO

1XT4 12W INCL.
[R 15801] GEAR INCL.

PVC /
PVC

A to B / 220-240V ~ 50-60 Hz / 0.41 kg / 0.90 lb

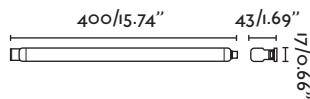

1XT4 20W INCL.
[R 15803] GEAR INCL.

PVC /
PVC

A to B / 220-240V ~ 50-60 Hz / 0.41 kg / 0.90 lb

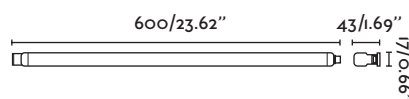

laMpi

OUT OF CATALOGUE
DESCATALOGADO

62066



white
blanco

HF

1XT5 13W INCL.
[R 15841] GEAR INCL.

PVC /
PVC

A to B / 220-240V ~ 50-60 Hz / 0.44 kg / 0.97 lb

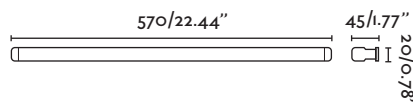

HF Until stock exhaustion
Hasta final de stock
Jusqu'à la fin de stock



SOCKET MR 16 /
PORTALÁMPARAS MR 16

4R033

0.2 kg / 0.44 lb



SOCKET GU 10 /
PORTALÁMPARAS GU 10

43065

0.05 kg / 0.11 lb



DRIVER 3W 350mA

46060



white
blanco

INPUT 240V - AC 50-60HZ. OUTPUT 350 mA MIN.
1W - MAX. 3W
0.05 kg / 0.11 lb

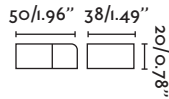

DRIVER 16W 350mA

46061



white
blanco

INPUT 240V - AC 50-60HZ. OUTPUT 350 mA MIN. 3W - MAX.
16W
0.14 kg / 0.31 lb

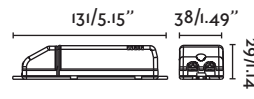

ELECTRONIC GEAR 60W / TRANSFORMADOR
ELECTRÓNICO REGULABLE 60W

43070



white
blanco

POWER FACTOR 0,99
INPUT 220-240V. 50-60 HZ. OUTPUT 11,5V 10-60W
0.06 kg / 0.13 lb

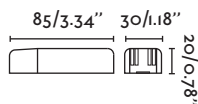

INFOR MATION ION



**ENG****faro** Barcelona Technical Laboratory

Faro Barcelona has extended the capacity of its Quality Control Department by equipping its laboratory with machinery that can conduct the following tests:

- IP Tests
- Incandescent thread.
- Electric shocks.
- Thermal and mechanical resistance.
- Impacts.
- Consumption and power factors.

Thanks to these advances, Faro Barcelona has raised the bar regarding the thoroughness of its tests and ensures that European regulations and standards are complied with fully.

Faro collaborates on improvements to the environment

With its commitment to efficient light bulbs and its contribution to energy saving and the campaign against global warming.

In Faro catalogues, next to the standard-use light bulb given for each item, you will see the recommended low-energy light bulb, highlighted by this symbol: [ref.] [LED ref.]

ESLaboratorio técnico propio de **faro** Barcelona

Faro Barcelona ha ampliado la capacidad de su Departamento de Control de Calidad, dotando su laboratorio de una maquinaria capaz de hacer los siguientes ensayos:

- Pruebas de IP
- Hilo incandescente.
- Choques eléctricos.
- Resistencia térmica y mecánica.
- Choques de impacto.
- Consumos y factores de potencia.

Gracias a estos avances, Faro Barcelona eleva el nivel de rigurosidad en sus ensayos y garantiza el estricto cumplimiento de las normativas y estándares europeos.

Faro colabora en la mejora del medio ambiente

Apostando por las bombillas eficientes y contribuyendo con el ahorro energético y la lucha contra el calentamiento global.

En los catálogos Faro podrá encontrar junto a la bombilla de uso standard de cada artículo cual es la bombilla de bajo consumo que recomendamos y lo diferenciamos con este símbolo: [ref.] [LED ref.]

FRLaboratoire technique appartenant à **faro** Barcelona

Faro Barcelona a élargi la capacité de son Département de contrôle qualité, en dotant son laboratoire de machines capables de procéder aux essais suivants:

- Essais d'IP
- Fil incandescent.
- Chocs électriques.
- Résistance thermique et mécanique.
- Chocs d'impact.
- Consommations et facteurs de puissance.

Grâce à ces avancées, Faro Barcelona élève le niveau de rigueur de ses essais et garantit le strict respect des réglementations et normes européennes.

Faro participe à l'amélioration de l'environnement

En misant sur des ampoules efficaces, en contribuant aux économies d'énergie et en participant à la lutte contre le réchauffement de la planète.

Dans les catalogues Faro, vous trouverez, à côté de l'ampoule standard utilisée pour chaque article, l'ampoule basse consommation recommandée et identifiée par ce symbole: [réf.] [LED réf.]

PTLaboratório técnico próprio da **faro** Barcelona

A Faro Barcelona ampliou a capacidade do seu Departamento de Controlo de Qualidade, dotando o seu laboratório de uma maquinaria capaz de fazer os seguintes ensaios:

- Testes de IP
- Fio incandescente.
- Choques eléctricos.
- Resistência térmica e mecânica.
- Choques de impacto.
- Consumos e factores de potência.

Graças a estes avanços, a Faro Barcelona eleva o nível de rigor nos seus ensaios e garante o estrito cumprimento das normas e padrões europeus.

A Faro colabora na melhoria do meio ambiente

Apostando nas lâmpadas eficientes e contribuindo para a poupança energética e para a luta contra o aquecimento global.

Nos catálogos Faro poderá encontrar, junto à lâmpada de uso padrão de cada artigo, a lâmpada de baixo consumo recomendada e que se diferencia com este símbolo: [ref.] [LED ref.]

GEREigenes technisches Labor von **faro** Barcelona

Faro Barcelona hat die Leistungsfähigkeit seiner Qualitätssicherungsabteilung durch die Ausstattung seines Labors mit Einrichtungen für folgende Tests erweitert.

- IP-Tests
- Thermische und mechanische Elektroschocks Widerstandskraft
- Mechanische Stöße
- Verbrauchs- und Leistungsaspekte
- Glühfäden

Dank dieser Erweiterungen kann Faro Barcelona jetzt seine Produktprüfungen noch wesentlich rigoroser durchführen und eine strikte Erfüllung der europäischen Normen und Standards garantieren.

Faro bemüht sich ständig um den Umweltschutz

Daher verwenden wir immer mehr effiziente Leuchtmittel und tragen damit zum Einsparen von Energie und zum Kampf gegen die Klimaerwärmung bei.

In den Katalogen von Faro finden Sie neben den Standard-Leuchtmitteln für die einzelnen Artikel auch jeweils passende Sparbirnen, die mit folgendem Symbol gekennzeichnet sind: [ref.] [LED ref.]

NLEigen technisch laboratorium van **faro** Barcelona

Faro Barcelona heeft de capaciteit van haar Afdeling Kwaliteitscontrole uitgebreid met een laboratorium waarin de volgende testen kunnen worden uitgevoerd:

- Testen van de IP-code
- Gloeidraad.
- Elektrische schokken.
- Thermische en mechanische weerstand.
- Schok door impact.
- Verbruik en vermogensfactoren.

Dankzij deze vooruitgang is er bij Faro Barcelona sprake van een hoger striktheidniveau tijdens het testen en garandeert een strikte naleving van de Europese normen en standaards.

Faro werkt mee aan de verbetering van het milieu

Middels het gebruik van efficiënte lampen. Zo draagt zij bij aan de energiebesparing en aan de strijd tegen de opwarming van de aarde.

In de catalogi van Faro treft u naast de lamp voor standaardgebruik van ieder artikel de aanbevolen lamp met laag verbruik aan die met dit symbool wordt onderscheiden: [ref.] [LED ref.]

BLСобствена техническа лаборатория на **faro** Barcelona

Faro Barcelona разшири капацитета на своя Отдел за контрол на качеството, като обзаведе лабораториите си с оборудване за осъществяване на следните изпитвания:

- Изпитвания за степен на защита (IP)
- Термична и механична
- Токови удари. Сустойчивост.
- Удари в твърд предмет.
- Консумирана мощност
- Нажежена жичка. и коефициент на мощността.

По този начин Faro Barcelona повишава точността на изпитванията и гарантира стриктно спазване на европейските.

Faro съдейства за подобряване на околната среда чрез използване на енергоспестяващи крушки, с което дава своя принос в борбата с глобалното затопляне.

В каталозите на Faro всеки продукт може да се използва както със стандартна, така и с енергоспестяваща крушка, която е препоръчителна и е означена със следния символ: [спра.] [LED спра.]

PLLaboratorium techniczne należąca do **faro** Barcelona

Firma Faro Barcelona rozszerzyła zakres kompetencji swojego Działu Kontroli Jakości, wyposażając laboratorium w urządzenia wykonujące następujące testy:

- Próby IP
- Włókno żarzenia.
- Porażenia prądem.
- Wytrzymałość termiczna i mechaniczna.
- Wstrząsy.
- Zużycie i czynniki mocy.

Dzięki tym procedurom firma Faro Barcelona zaostrzyła poziom testów, gwarantując bezwzględne przestrzeganie norm i standardów europejskich.

Firma Faro chroni środowisko Stawiając na wydajne żarówki i oszczędność energii, przyczyniając się tym samym do walki z globalnym ociepleniem.

Oprócz informacji o standardowych żarówkach, katalogi Faro zawierają zalecenia dotyczące żarówek energooszczędnych wyróżnione tym symbolem: [odni.] [LED odni.]



I

Laboratorio tecnico proprio di faro Barcelona

Faro Barcellona ha ampliato la capacità del suo Dipartimento di Controllo della Qualità, dotando il suo laboratorio di macchinari in grado di realizzare i seguenti test:

- Prove di IP
- Filo incandescente.
- Scariche elettriche.
- Resistenza termica e meccanica.
- Test di impatto.
- Consumi e fattori di potenza.

Grazie a questi progressi, Faro Barcelona alza il livello di rigorosità nei suoi test e garantisce il rigido rispetto delle normative e degli standard europei.

Faro collabora al miglioramento dell'ambiente

Scommettendo sulle lampadine efficienti e contribuendo al risparmio energetico e alla lotta contro il riscaldamento globale. Nei cataloghi Faro potrete trovare, assieme alla lampadina d'uso standard di ogni articolo, la lampadina di basso consumo consigliata e che si distingue con questo simbolo: [rif.] [LED rif.]

GRK

faro Barcelona Technical Laboratory

Η Faro Barcelona έχει διευρύνει τις δυνατότητες του Τμήματος Ελέγχου Ποιότητας, εξοπλίζοντας το εργαστήριό της με μηχανήματα που πραγματοποιούν τα εξής τεστ:

- Τεστ IP
- Νήμα πυρακτώσεως.
- Ηλεκτροπληξία.
- Θερμική και μηχανική αντοχή.
- Κρούση.
- Κατανάλωση και παράγοντες ισχύος.

Χάρη σε αυτές τις εξελίξεις, η Faro Barcelona αυξάνει το επίπεδο αυστηρότητας στις δοκιμές της και εξασφαλίζει την απόλυτη τήρηση των ευρωπαϊκών κανονισμών και προτύπων.

Η Faro συμβάλλει στη βελτίωση του περιβάλλοντος

χρησιμοποιώντας αποδοτικούς λαμπτήρες και συμβάλλοντας στην εξοικονόμηση ενέργειας και την καταπολέμηση της υπερθέρμανσης του πλανήτη.

Στους καταλόγους της Faro μπορείτε να βρείτε, μαζί με τον συμβατικό λαμπτήρα για κάθε προϊόν, τον συνιστώμενο λαμπτήρα χαμηλής κατανάλωσης που διακρίνεται με αυτό το σύμβολο: [αναφ.] [LED αναφ.]

RUS

Собственная техническая лаборатория компании faro Barcelona

Потенциал Отдела контроля качества компании Faro Barcelona увеличился благодаря появлению в лаборатории оборудования, с помощью которого можно проводить следующие испытания:

- Тестирование IP
- Механическое и
- Поражение электрическим током.
- Воздействие от столкновения.
- Потребление и
- Спираль накаливания. коэффициент мощности.

Благодаря этому компания Faro Barcelona предъявляет все более жесткие требования к проведению исследований и обеспечивает строгое соответствие европейским стандартам и нормам.

Faro заботится об окружающей среде
делая ставку на эффективные электрические лампы, позволяющие экономить энергию и бороться с глобальным потеплением.

В каталогах Faro можно найти как стандартные лампы различных типов-размеров, так и рекомендуемые энергосберегающие лампы, отмеченные специальным символом: [ссы.] [LED ссы.]

CZ

Собственная техническая лаборатория компании faro Barcelona

Потенциал Отдела контроля качества компании Faro Barcelona увеличился благодаря появлению в лаборатории оборудования, с помощью которого можно проводить следующие испытания:

- Тестирование IP
- Механическое и
- Поражение электрическим током.
- Воздействие от столкновения.
- Потребление и
- Спираль накаливания. коэффициент мощности.

Благодаря этому компания Faro Barcelona предъявляет все более жесткие требования к проведению исследований и обеспечивает строгое соответствие европейским стандартам и нормам.

Používáním efektivních žárovek přispívá firma Faro ke zlepšení životního prostředí, úspoře elektrické energie a boji proti globálnímu oteplování.

V katalozích Faro naleznete vedle standardní žárovky vhodné pro jednotlivé zboží i doporučenou žárovku s nízkou spotřebou, která je označena tímto symbolem: [ref.] [LED ref.]

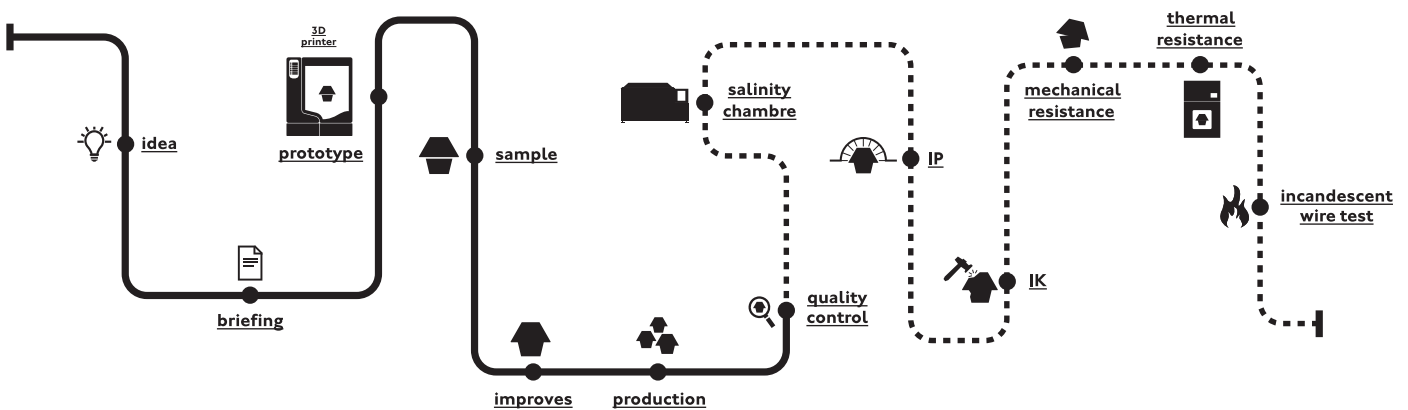



ENG

The first digit (IP x...) indicates the protection from solid objects.

- 4** Protected against solid objects bigger than 1 mm.
- 6** Dust tight.

The second digit (IP ...y) indicates protection from moisture.

- 4** Protected against splashing water.
- 5** Protected against water jets.
- 7** Protected against the effects of immersion.

ES

La primera cifra (IP x...) indica la protección del aparato contra la penetración de cuerpos sólidos.

- 4** Protegido contra la penetración de cuerpos sólidos con $\varnothing \geq 1$ mm
- 6** Totalmente protegido contra el polvo

La segunda cifra (IP ...y) indica la protección del aparato contra la lluvia.

- 4** Protegido contra salpicaduras y protección del agua
- 5** Protegido contra chorros de agua
- 7** Protegido contra inundaciones temporales.

FR

Le premier chiffre (IP x...) indique le degré de protection des parties contre les corps solides.

- 4** Protection contre corps de diamètre supérieur à 1 mm.
- 6** Protection contre toute infiltration de poussière.

Le deuxième chiffre (IP ...y) indique le degré de protection contre l'eau.

- 4** Protection contre projections d'eau de toutes les directions.
- 5** Protection contre jets d'eau de toutes les directions.
- 7** Protection contre immersion à moins d'un mètre de profondeur.

PT

O primeiro dígito (IP x...) indica o grau de protecção contra corpos sólidos.

- 4 Protegido contra a penetração de corpos sólidos com $\varnothing > 1$ mm.
- 6 Totalmente protegido contra o pó.

O segundo dígito (IP ...y) indica o grau de protecção contra po e chuva.

- 4 Protegido contra projecções de água.
- 5 Protegido contra jactos de água em todas as direcções.
- 7 Protegido contra a imersão temporária.

GER

Die erste Ziffer (IP x...) gibt den Schutz des Apparats gegen das Eindringen von festen Körpern an.

- 4 Geschützt gegen das Eindringen von festen Körpern mit $\varnothing \geq 1$ mm.
- 6 Vollkommen gegen Staub geschützt.

Die zweite Ziffer (IP ...y) gibt den Schutz des Apparats gegen Regen an.

- 4 Geschützt gegen Spritzer und Schutz gegen Wasser.
- 5 Geschützt gegen Wasserschauer.
- 7 Geschützt gegen zeitweilige Überschwemmungen.

NL

Het eerste cijfer (IP x...) geeft de beschermingsgraad weer van het apparaat tegen het binnendringen van vaste elementen.

- 4 Biedt bescherming tegen het binnendringen van vaste elementen met $\varnothing \geq 1$ mm.
- 6 Biedt volledige bescherming tegen stof.

Het tweede cijfer (IP ...y) geeft de beschermingsgraad van het apparaat tegen de regen weer.

- 4 Biedt bescherming tegen spetters en tegen water.
- 5 Biedt bescherming tegen waterstralen.
- 7 Biedt bescherming tegen tijdelijke overstromingen.

I

La prima cifra (IP x...) indica la protezione del sistema contro l'ingresso di corpi solidi.

- 4 Protetto contro l'ingresso di corpi solidi con $\varnothing \geq 1$ mm.
- 6 Totalmente protetto contro la polvere.

La seconda cifra (IP ...y) indica la protezione del sistema contro la pioggia.

- 4 Protetto contro gli spruzzi e l'ingresso di acqua.
- 5 Protetto contro i getti d'acqua.
- 7 Protetto contro inondazioni temporanee.

GRK

Το πρώτο νούμερο (IP x...) υποδεικνύει την προστασία της συσκευής κατά της διείσδυσης στερεών αντικειμένων.

- 4 Με προστασία κατά της διείσδυσης στερεών αντικειμένων διαμέτρου $\varnothing \geq 1$ mm
- 6 Με πλήρη προστασία κατά της σκόνης

Το δεύτερο νούμερο (IP ...y) υποδεικνύει την προστασία της συσκευής κατά της βροχής.

- 4 Με προστασία κατά των πιτσιλισμάτων και προστασία νερού
- 5 Με προστασία κατά της ροής νερού
- 7 Με προστασία κατά των παροδικών πλημμυρών

RUS

Первая цифра (IP x...) указывает на защиту прибора от проникновения твердых тел.

- 4 Защищен от проникновения твердых тел $\varnothing \geq 1$ мм
- 6 Полностью защищен от пыли

Вторая цифра (IP ...y) указывает на защиту прибора от воды.

- 4 Защищен от брызг и попадания воды
- 5 Защищен от потоков воды
- 7 Защищен от проникновения воды при временном затоплении

CZ

První číslice (IP x...) označuje stupeň ochrany přístroje proti průniku pevných částic.

- 4 Chráněno proti průniku pevných částic s $\varnothing \geq 1$ mm
- 6 Kompletně chráněno proti prachu

Druhá číslice (IP ...y) označuje ochranu proti vnikání vlhkosti.

- 4 Ochrana před stříkající vodou.
- 5 Ochrana před tryskající vodou (tlakovou vodou).
- 7 Ochrana při dočasném ponoření.

BL

Първата цифра (IP x...) означава защита на уреда от попадане на твърди тела.

- 4 Защита от попадане на твърди тела с $\varnothing \geq 1$ mm
- 6 Изцяло защитен от прах

Втората цифра (IP ...y) указва нивото на защита от влага.

- 4 защитен от пръскаща вода
- 5 защитен от водна струя
- 7 защитен от ефекта на потапяне

PL

Pierwsza cyfra (IP x...) oznacza zabezpieczenie urządzenia przed wnikaniem ciał stałych.

- 4 Zabezpieczono przed wnikaniem ciał stałych za pomocą $\varnothing \geq 1$ mm
- 6 Całkowicie zabezpieczono przed pyłem

Druga z cyfr kodu (IP ...y) oznacza stopień ochrony przed wilgocią.

- 4 ochrona przed rozbryzgującą się wodą
- 5 ochrona przed strumieniami wody
- 7 ochrona przed zanurzeniem krótkotrwałym w wodzie



	ENG	ES	FR	PT	GER	NL
	Has a protective earth Class I protection	Con toma de tierra Aisla. clase I	Avec prise de terre Catégorie de protection I	Com ligação terra Isolamento classe I	Mit Erdung Isolierung der Klasse I	Met aardleiding Isolatie klasse I
	Reinforced or double insulation (class II protection)	Aislamiento clase II	Isolement de protection (classe de protection II)	Isolamento (clase II)	Isolierung der Klasse II	Isolatie klasse II
	Low voltage protection (class III protection)	Aislamiento clase III	Très basse tension de protection (classe protec. III)	Isolamento (clase III)	Isolierung der Klasse III (für montage auf)	Isolatie klasse III
	No incandescent bulb	No bombilla incandescente	Pas utiliser ampoule incandescence	Não use lâmpada incandescente	Nicht verwenden Glühlampe	Gebruik geen gloeilamp
	Not included Included	No incluida Incluida	Non incluse Incluse	Não incluida Incluida	Nicht eingeschlossen Eingeschlossen	Niet inbegrepen Inbegrepen
	Cable	Cable	Câble	Cabo	Kabel	Kabel
	Switch	Interruptor	Interrupteur	Interruptor	Schalter	Schakelaar
	Double Switch	Doble Interruptor	Double Interrupteur	Doble Interruptor	Doppelter Schalter	Dubbele Schakelaar
	Special Transformer Included	Transformador Especial Incluido	Transformateur Spécial Inclus	Transformador Especial Incluido	Spezieller Transformator Eingeschlossen	Speciale Transformator Inbegrepen
	With equipment, ballast included	Con equipo, reactancia incluida	Avec l'équipement, ballast inclus	Com equipamento, equipamento incluido	Ausrüstung, reaktanz inbegriffen	Met uitrusting, reactancia inbegrepen
	Spare Part	Repuesto o Recambio	Pièce De Rechange	Substituição	Ersatzteil Oder Austauscheteil	Voorraad Of Vervanging
	Cut out	Agujero para empotrar	Trou d'encastrement	Furo para encastrar	Bohrloch zum Einbauen	Gat om in te bouwen
	Adjustable	Orientable	Orientable	Ajustável	Verstellbar	Verstelbare
	Adjustable	Orientable	Orientable	Ajustável	Verstellbar	Verstelbare
	Adjustable	Orientable	Orientable	Ajustável	Verstellbar	Verstelbare
	Adjustable	Orientable	Orientable	Ajustável	Drehbar	Verstelbare
	Diopters	Dioptrias	Dioptries	Dioptrias	Dioptrien	Dioptrieën
	Dimmable	Dimable	Réglable	Regulável	Dimmbar	Dimbaar
	Light up	Luz arriba	Lumière de haut	Luz para cima	Licht auf	Lichte omhoog
	Light down	Luz abajo	Lumière vers les bas	Luz para baixo	Licht nach unten	Licht omlaag
	Light up and down	Luz arriba y abajo	Lumière de haut en bas	Luz para cima e para baixo	Licht auf und ab	Licht boven en beneden
	Beam angle	Grados apertura	Grades halo lumineux	Notas luz	Light grade	Licht rangen
	Remote Control	Mando a Distancia	Télécommande	Comando À Distancia	Vernbedienung	Dubbele Intensiteit
	Recessed box	caja empotrar	Boîte encastrée	Recesso box	Einbaugehäuse	Recessed box
	Blister	Blister	Blister	Blister	Blister	Blister



SYMBOLS/SÍMBOLOS/SYMBOLS/SIMBOLI

	<u>I</u>	<u>GRK</u>	<u>RUS</u>	<u>CZ</u>	<u>BL</u>	<u>PL</u>
	Con messa a terra Isola. tipo I	Με γείωση Μόνωση κλάσης I	С контактом заземления Изоляция класс I	S uzemněním Izolace třídy I	Със заземляване Изолация клас I	Z uziemieniem Izolacja klasy I
	Isolamento tipo II	Μόνωση κλάσης II	Изоляция класс II	Izolace třídy II	Изоляция клас II	Izolacja klasy II
	Isolamento tipo III	Μόνωση κλάσης III	Изоляция класс III	Izolace třídy III	Изоляция клас III	Izolacja klasy III
	Non lampadina a incandescenza	Δεν λάμπα πυρακτώσεως	нет накаливания	No žárovka	не крушка с нажежаема жичка	żarówka nie używać
	Non inclusa Inclusa	Δεν συμπεριλαμβάνεται συμπεριλαμβάνεται	Не включена включена	Není přiložena Přiložena	Не е включена Включена	Nie dołączono Dołączono
	Cavo	Καλώδιο	кабель	kabel	кабел	kabel
	Interruttore	Διακόπτης Διπλός	Выключатель	Vypínač	Прекъсвач	Wyłącznik
	Doppio Interruttore	Διακόπτης	Двойной Выключатель	Dvojitý Vypínač	Двоен Прекъсвач	Podwójny Wyłącznik
	Trasformatore Speciale Inclusa	Ειδικός Μετασχηματιστής	Специальный Трансформатор	Speciální Transformátor	Специален Трансформатор	Specjalny Transformator
	Con attrezzatura reattanza inclusa	Με εξοπλισμό Συμπεριλαμβάνεται αντίσταση	С оборудованием сопротивление включено	Včetně zařízení reaktance	С оборудване включено съпротивление	Zestaw reaktancji w komplecie
	Pezzi Di Ricambio	Ανταλλακτικό	Сменная Или Запасная Деталь	Náhradní Díly Nebo	Резервни Части Или	Części Zamiennych Lub
	Foro per incasso	Οπή για εντοίχιση	Отверстие для встраивания	Otvor k vložení	Μонтажен отвор	Otwór do mocowania
	Regolabile	ρυθμιζόμενο	Регулируемый	Nastavitelný	Ρεгулируеми	Orientacja
	Regolabile	ρυθμιζόμενο	Регулируемый	Nastavitelný	Ρεгулируеми	Orientacja
	Regolabile	ρυθμιζόμενο	Регулируемый	Nastavitelný	Ρεгулируеми	Orientacja
	Regolabile	ρυθμιζόμενο	Регулируемый	Nastavitelný	Ρεгулируеми	Orientacja
	Dioptrie	Διοπτριών	Диоптрий	Dioptrie	Диоптъра	Dioptrii
	Regolabile	ροοστάτη	затемняемый	Stmívatelné	диммиране	ściemniania
	Luce su	φως εγγραφη	Свет вверх	Osvětlit	лайт нагоре	Zapalać się
	Luce giù	φως κάτω	Свет вниз	Světlo dolů	лайт надолу	Światło w dół
	Luce su e giù	φως εγγραφη και κάτω	Свет вверх и вниз	Světlo nahoru a dolů	лайт нагоре и надолу	Światło w górę iw dół
	Gradi di luce	φως βαθμών	Светлые сорта	Světlo třídy	Светлинии марки	Lekkie klasy
	Doppia Intensità	Τηλεχειριστήριο	Дистанционное Управление	Dálkové Ovládání	Дистанционно Управление	Zdalne Sterowanie
	Incasso box	χωνευτα κουτι	Монтажная коробка	Recessed box	за вграждане box	Puszka
	Blister	Blister	Blister	Blistr	блистер	Blister



MATERIALS/MATERIALES/MATÉRIAUX/ MATERIALI

	<u>ES</u>	<u>FR</u>	<u>PT</u>	<u>GER</u>	<u>NL</u>	<u>I</u>
ABS	ABS	ABS	ABS	ABS	ABS	ABS
ACRYLIC	Acrílico	Acrylique	Acrílico	Acryl	Acryl	Acrílico
ALUMINIUM	Aluminio	Aluminium	Alumínio	Aluminium	Aluminium	Alluminio
BUBBLE GLASS	Cristal burbuja	Verre bullé	Vidro bolha	Blasenglas	Bubble glas	Vetro bolla
DIE CAST ALUMINIUM	Aluminio inyectado	Fonte d'aluminium	Alumínio fundido	Aluminiumguss	Gegoten aluminium	Ghisa alluminio
ENAMEL	Esmalte					
FIBER GLASS	Fibra de Vidrio	Fibre De Verre	Fibra De Vidro	Fiberglas	Glasvezel	Fibra Di Vetro
GLASS	Cristal	Verre	Vidro	Glas	Glas	Vetro
MARBLE	Mármol	Marbre	Mármore	Marble	Marmeren	Marmo
METAL	Metal	Métal	Metal	Metall	Metaal	Metallo
OPAL ACRYLIC	Acrílico opal	Acrylique opale	Opal acrílico	Opalacryl	Opaal acrylaat	Acrílico opale
OPAL GLASS	Cristal opal	Verre opale	Vidro opal	Opalglas	Opaal glas	Vetro opalino
OPAL PMMA	PMMA opale	PMMA opale	PMMA opal	Opal PMMA	Opaal PMMA	PMMA opale
OPAL POLYCARBONATE	Policarbonato opal	Polycarbonate opale	Policar-bonato opal	Opal polycarbonat	Opaal polycarbonat	Policar-bonato opale
OPAL PVC	Opal PVC	PVC opale	PVC opal	Opal PVC	Opaal PVC	PVC opale
OPTICAL GLASS	Cristal óptico	Verre optique	Vidro óptico	Optisches Glas	Optisch glas	Vetro ottico
PAPYRUS	Papiro	Papyrus	Papiro	Papyrusses	Papyrus	Papiro
PARCHMENT	Pergamino	Parchemin	Pergaminho	Pergament	Perkament	Pergamena
PEMD	PEMD	PEMD	PEMD	PEMD	PEMD	PEMD
PLAST	Yeso	Gypse	Gesso	Gips	Gips	Gesso
PMMA	PMMA	PMMA	PMMA	PMMA	PMMA	PMMA
POLYCARBONATE	Policarbonato	Polycarbonate	Policarbonato	Polycarbonat	Polycarbonaat	Policarbonato
POLYMER	Polímero	Polymères	Polímero	Polymer	Polymeer	Polimero
POLYPROPYLENE	Polipropileno	Polyéthylène	Poliétileno	Polyethylen	Polyethyleen	Poliétilene
PVC	PVC	PVC	PVC	PVC	PVC	PVC
RATTAN	Rattan	Rotin	Rattan	Rattan	Rattan	Rattan
RESINE	Resina	Résine	Resina	Harz	Hars	Resina
RUSTIC GLASS	Cristal rústico	Verre rustique	Vidro rústico	Rustikale Glas	Rustieke Glas	Vetro rustico
SILICONE	Silicona	Silicone	Silicone	Silicon	Silicone	Silicone
STAINLESS STEEL	Acero inoxidable	Acier inoxydable	Aço inoxidável	Edelstahl Rostfreier	Roestvrij staal	Acciaio inossi.
STEEL	Acero	Acier	Aço	Stahl	Staal	Acciaio
SUEDE	Ante	Verre Tiffany	Vidro Tiffany	Tiffany-Glas	Tiffany Glas	Vetro Tiffany
TEFLON	Teflón	Teflon	Teflon	Teflon	Teflon	Teflon
TEXTILE	Téxtil	Textile	Téxtil	Textile	Textiel	Tessile
TRANSLUCENT GLASS	Cristal translúcido	Verre translucide	Vidro translúcido	Translucent Glas	Doorschijnend glas	Vetro traslucido
TRANSLUCENT POLYCARBONATE	Policarbonato translúcido	Polycarbonate translucide	Policar-bonato transl.	Translucent polycarbonat	Doorschijnend polycarbo.	Policar-bonato transl.
TRANSPARENT GLASS	Cristal transparente	Verre transparent	Vidro transpa.	Transparentem Glas	Transparant glas	Vetro trasparente
TRANSPARENT PMMA	PMMA Transparente	PMMA transparent	PMMA transpa.	Transparentem PMMA	Transparant PMMA	PMMA trasparente
WOOD	Madera	Bois	Madeira	Holz	Hout	Legno
ZINC	Zinc	Zinc	Zinco	Zink	Zink	Zinco



MATERIALS/MATERIALES/MATÉRIAUX/ MATERIALI

	<u>GRK</u>	<u>RUS</u>	<u>CZ</u>	<u>BL</u>	<u>PL</u>
ABS	ABS	ABS	ABS	ABS	ABS
ACRYLIC	Ακρυλικό	Акриловый	Akryl	Акрил	Akrylowy
ALUMINIUM	Αλουμίνιο	Алюминий	Hliník	Алюминий	Aluminium
BUBBLE GLASS	Υαλί φούσκα	Рузырь стекло	Bublina sklo	балон стъкло	Szklane bańki
DIE CAST ALUMINIUM	Χυτό αλουμίνιο	Ритого алюминия	Z litého hliníku	Рят алуμινий	Odlaw aluminiowy
ENAMEL					
FIBER GLASS	Πολυεστερικός	Стекловолокно	Laminát	Фибροστъкло	Włókno Szklane
GLASS	Υαλί	Стекло	Sklo	Стъкло	Szkło
MARBLE	Μαρμαρα	Мрамор	Mramorová	Мрамор	Marmur
METAL	Μέταλλο	Μεταλλ	Kov	Μεταλλ	Metal
OPAL ACRYLIC	Οπαλ ακρυλικό	Опалового акрила	Opálový akrylát	Οπαλ ακριλ	Opal akryl
OPAL GLASS	Οπαλ γυαλί	Ματωвое стекло	Opálové sklo	Μλечно стъкло	Szkło mleczne
OPAL PMMA	Οπαλ PMMA	PMMA ακρυλικές	Opal PMMA	Οπαλ PMMA	Mlecznego PMMA
OPAL POLYCARBONATE	Οπαλ πολυάνθρακας	Οπαλ πολυκαρβонат	Opal polykarbonát	Οπαλ πολυκαρβонат	Mlecznego Poliwęglan
OPAL PVC	Οπαλ PVC	Οπαλ PVC	Opal PVC	Οπαλ PVC	PVC Poliwęglan
OPTICAL GLASS	Οπτική γυαλί	Οπτικеское стекло	Optické sklo	Οπτικно стъкло	Szklá optycznego
PAPYRUS	Πάπυρος	Папирус	Papyrus	Ραпуrus	Papyrus
PARCHMENT	Περγαμηνή	Περγαμεντ	Pergamen	Περγαμεντ	Pergamin
PEMD	PEMD	PEMD	PEMD	PEMD	PEMD
PLAST	Γύψος	Гипс	Sádrovec	Гипс	Gips
PMMA	PMMA	PMMA	PMMA	PMMA	PMMA
POLYCARBONATE	Πολυκαρβονικά	Πολυκαρβонат	Polykarbonát	Πολυκαρβонат	Poliwęglan
POLYMER	Πολυμερές	Πολυμερ	Polymer	Πολυμερ	Polimer
POLYPROPYLENE	Πολυαιθυλένιο	Πολυεθιлен	Polyethylen	Πολυεθιлен	Polietylen
PVC	PVC	PVC	PVC	PVC	PVC
RATTAN	Rattan	Ροτανг	Rattan	Rattan	Rattan
RESINE	Ρητινouxo	Смoла	Pryskyřice	Смoла	Żywica
RUSTIC GLASS	ροустίκ γυαλί	Сельский стекла	Rustikální sklo	Ρουстик стъкло	Rustic Szkło
SILICONE	Σιλικoνη	Силикон	Silikonová	Силикон	Silikon
STAINLESS STEEL	Ανοξειδωτο χάλυβα	нержавеющая сталь	Nerez	нерждаема стомана	Stali nierdzewnej
STEEL	χάλυβας	сталь	Ocel	Стомана	Stal
SUEDE	Tiffany γυαλί	Тиффани Стекла	Tiffany Skleněné	Tiffany Стъкло	Tiffany Szkła
TEFLON	Τεφλόν	Τεφлон	Teflon	Τεφλοново	Teflon
TEXTILE	Υφάσματα	Текстильный	Textilní	Τекстилен	Włókienniczy
TRANSLUCENT GLASS	Διαφανές γυαλί	Προзрачные стекла	Transluent stъкло	Průhledné sklo	Przezroczyste szkło
TRANSLUCENT POLYCARBONATE	Διαφανές πολυάνθρακας	Προзрачные πολυκαρβонат	Transluent polykarbonát	Průhledné πολυκαρβонат	Przezroczyste Poliwęglan
TRANSPARENT GLASS	Διαφανές γυαλί	Прозрачное стекло	Průhledné sklo	Прозрачно стъкло	Przezroczystego szkła
TRANSPARENT PMMA	Διαφανές PMMA	Прозрачное PMMA	Průhledné PMMA	Прозрачно PMMA	Przezroczystego PMMA
WOOD	Ξύλο	Дерево	Dřevo	Дърво	Drewno
ZINC	Ψευδάργυρος	Цинк	Zinek	Цинк	Cynk



FINISHES/ACABADOS/FINITIONS/ RIFINITURE



ALUMINIUM
ALUMINIO
ALUMINIUM
ALLUMINIO



BEIGE
BEIGE
BEIGE
BEIGE



BLACK
NEGRO
NOIR
NERO



BORDEAUX
BURDEOS
BORDEAUX
BORDEAUX



BRONZE
BRONCE
BRONZE
BRONZO



BROWN
MARRÓN
MARRON
MARRONE



BRUSHED ALUMINIUM
ALUMINIO CEPILLADO
ALUMINIUM BROSE
ALLUMINIO SPAZZOLATO



CHOCOLATE BROWN
MARRÓN CHOCOLATE
MARRON CHOCOLAT
MARRONE CIOCCOLATO



CHROME
CROMO
CHROME
CROMATO



CORAL RED
ROJO CORAL
ROUGE CORAIL
ROSSO CORALLO



DARK BROWN
MARRÓN OSCURO
MARON FONCÉ
MARRONE SCURO



DARK GREEN
VERDE OSCURO
VERT FONCÉ
VERDE SCURO



DARK GREY
GRIS OSCURO
GRIS FONCÉ
GRIGIO SCURO



ELECTRIC BLUE
AZUL ELÉCTRICO
BLEU ELECTRIQUE
AZZURRO ELETTRICO



GOLD
ORO
OR
ORO



GREY
GRIS
GRIS
GRIGIO



LIME GREEN
VERDE LIMA
VERT LIME
VERDE LIMA



MAGENTA
MAGENTA
MAGENTA
MAGENTA



MAHOGANY BROWN
MARRÓN CAOBA
MARRON ACAJOU
MOGANO



MARINE BLUE
AZUL MARINO
BLEU MARINE
AZZURRO MARINO



MATT BLACK
NEGRO MATE
NOIR MAT
NERO OPACO



MATT NICKEL
NÍQUEL MATE
NICKEL MAT
NICKELATO OPACO



MATT WHITE
BLANCO MATE
BLANC MAT
BIANCO OPACO



MIRROR
ESPEJO
MIROIR
SPECCHIO

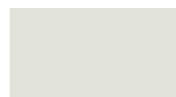

OFF WHITE
BLANCO ROTO
BLANC CASSÉ
BIANCO ROTTO



OLD GOLD
ORO ENVEJECIDO
OR ANTIQUE
ORO ANTICHIZZATO



OLIVE GREEN
VERDE OLIVA
VERT OLIVE
VERDE OLIVA



OLIVE GREY
VERDE GRIS
GRIS OLIVE
GRIGIO VERDE



ORANGE
NARANJA
ORANGE
ARANCIONE



ORANGE BROWN
MARRÓN ANARANJADO
MARRON ORANGÉ
MARRONE ARANCIO



ORANGE RED
ROJO ANARANJADO
ROUGE ORANGÉ
ROSSO ARANCIO



PALE BROWN
MARRÓN PARDO
MARRON CLAIR
MARRONE CASTAGNO



PALE GREEN
VERDE PASTEL
VERT CLAIR
VERDE PASTELLO



PINK
ROSA
ROSE
ROSA



PISTACHIO GREEN
VERDE PISTACHO
VERT PISTACHE
VERDE PISTACCIO



POLISHED ALUMINIUM
ALUMINIO PULIDO
ALUMINIUM POLI
ALLUMINIO PULITO



PURE GREEN
VERDE VIVO
VERT VIF
VERDE VIVO



PURPLE
LILA
VIOLET
VIOLETT



RED
ROJO
ROUGE
ROSSO



RUST BROWN
MARRÓN ÓXIDO
MARRON ROUILLE
MARRONE OSSIDATO



RUST GREEN
VERDE ÓXIDO
VERT ROUILLE
VERDE OSSIDATO



SHINY BLACK
NEGRO BRILLANTE
NOIR BRILLANT
NERO BRILLANTE



SILVER
PLATA
ARGENT
ARGENTO



SKY BLUE
AZUL CELESTE
BLEU AZUR
CELESTE



TRANSPARENT
TRANSPARENTE
TRANSPARENT
TRASPARENTE



WENGE
WENGUÉ
WENGUÉ
WENGUE



WHITE
BLANCO
BLANC
BIANCO



WOOD
MADERA
BOIS
LEGNO



YELLOW
AMARILLO
JAUNE
GIALLO



YELLOW GREEN
VERDE AMARILLENTO
VERT JAUNE
VERDE GIALLASTRO



HOME | HOGAR | INTERIEUR

Essential lighting

Amplio abanico de luminarias que ofrecen soluciones funcionales y adaptables a cualquier estilo decorativo (clásico, actual, rústico, elegante) y a cualquier aplicación (iluminación para dormitorios, salones, cocinas, baños y zonas de paso).

Essential lighting

Wide range of light fixtures that offer functional solutions, adaptable to any decorative style (classical, contemporary, rustic, elegant) and any application (lighting for bedrooms, living rooms, kitchens, bathrooms and hallways).

Essential lighting

Une vaste gamme de luminaires qui offrent des solutions fonctionnelles et adaptables à tous les styles de décoration (classique, moderne, rustique, élégante) et à toutes les applications (éclairage pour chambres, salons, cuisines, salles de bain et couloirs).

OUTDOOR | EXTERIOR | EXTERIEUR

Green innovation

Luminarias producidas con materiales y mediante procesos que le confieren una alta resistencia ante condiciones ambientales adversas y que contribuyen con el ahorro energético.

Nuestros modelos abarcan diferentes funcionalidades: apliques, proyectores, balizas, sobremuros, farolas.

Green innovation

Luminaires and fixtures are produced by processes and materials that give them high resistance to adverse environmental conditions and contribute to energy saving.

Our models cover different functionalities: sconces, spotlights, beacons, wallpost lights, lampposts.

Green innovation

Luminaires fabriqués avec des matériaux et des procédés qui leur confèrent une haute résistance aux conditions environnementales adverses et qui contribuent à réaliser des économies d'énergie.

Nos modèles sont très variés: appliques, projecteurs, balises, bornes, lampadaires.

FAN | VENTILACIÓN | VENTILATEUR

Designing the air

Nuestra gama de ventiladores es un referente a nivel europeo no sólo por sus diseños, sino también por la calidad de sus materiales. Modelos diseñados para respetar el silencio y el medio ambiente.

Designing the air

Our range of fans is a European benchmark not only in terms of design, but also the quality of materials. Model designed to respect noise levels and the environment.

Designing the air

Notre gamme de ventilateur est une référence au niveau européen, grâce au design des modèles mais également à la qualité de leurs matériaux.

Nos modèles sont conçus pour respecter le silence et l'environnement.

BULBS | BOMBILLAS | AMPOULES

Better light. Better world

Disponemos de una amplia gama de lámparas que presentan altos niveles de rendimiento y calidad en diferentes formatos: lámparas de bajo consumo, halógenas, led, etc.

Better light. Better world

We have a wide range of high-performance and top-quality lamps in different formats: energy-saving bulbs, halogen, LED, etc.

Better light. Better world

Nous disposons d'une vaste gamme d'ampoules qui offrent des performances et une qualité exceptionnelles dans divers formats: ampoules basse consommation, halogènes, LED, etc.



ES

La información referente a nuestros productos puede ser modificada con el fin de mejorar las características técnicas o de diseño.

Faro Barcelona se reserva el derecho de anular o modificar cualquier modelo sin previo aviso y sin que sea motivo de reclamaciones.

Las condiciones, características y precios de los productos que aparecen en este catálogo son los vigentes en la fecha de impresión del catálogo salvo error tipográfico y están sujetos a posibles modificaciones.

Los precios mostrados son precios de venta al público (PVP).

IVA NO INCLUIDO EN TARIFA

Tarifa no válida para Italia y Suiza.

Previa comunicación a Lorefar sólo se aceptará la mercancía devuelta por defectuosa, nunca por cristales rotos o falta de algún componente. En estos casos rogamos se pongan en contacto con nosotros para enviarles urgentemente las piezas requeridas.

No se admitirán cambios ni devoluciones de mercancía en buen estado. En caso de aceptación explícita por parte de Lorefar, a su recepción y comprobación se emitirá un cargo del 20% en concepto de depreciación y clasificación de la mercancía.

ENG

The technical information detailed in our catalogue can be modified in order to improve the features or design of our products.

Faro Barcelona keeps the right to cancel or modify any model without prior notice and without any cause for complaints.

The conditions, technical characteristics and prices of the products that appear in this catalogue are the effective ones in the date of impression of the catalogue except for typographical error and are subject to possible changes.

The catalogue prices are public prices.

RATES DO NOT INCLUDE VAT.

Price list not valid for Italy and Switzerland.

Returned goods shall only be accepted, after prior notice being given to LOREFAR, on the grounds of being defective and never on the basis of broken glass or missing parts. In such cases, please contact us so that we can send you the required parts as a matter of urgency.

Exchanges or returns of goods in good condition will not be accepted. In the event of express acceptance by LOREFAR, a 20% charge shall be incurred, on receipt and checking, for depreciation and classification of the goods.

FR

L'information qui se réfère à nos produits peut être modifiée afin d'améliorer les caractéristiques technique ou de design.

Faro Barcelona se réserve le droit d'annuler ou de modifier n'importe quel modèle sans préavis et sans que cela soit motif de réclamations.

Les conditions, caractéristiques et prix des produits qui apparaissent dans ce catalogue sont celles en vigueur à la date d'impression du catalogue sauf erreur typographique et sont susceptible d'être modifiées ultérieurement.

Les prix du catalogue son les prix de vente public .

IVA NON COMPRISE DANS LE TARIF.

Liste de prix pas valable pour l'Italie et la Suisse.

Seule sera acceptée en retour la marchandise défectueuse, et ce après communication à LOREFAR. LOREFAR n'acceptera jamais de retour pour du verre brisé ou pour l'absence d'un composant quelconque. Dans ces derniers cas, nous vous prions de vous mettre en contact avec nous afin que nous vous fassions parvenir dans les plus brefs délais les pièces nécessaires. La marchandise en bon état ne sera ni reprise ni échangée. En cas d'acceptation explicite de sa part, LOREFAR retiendra 20% au titre de la dépréciation et de la classification du produit.

PT

A informação referente aos nossos produtos pode ser modificada com o fim de melhorar as características técnicas ou de desenho.

A Faro Barcelona reserva-se o direito de anular ou modificar qualquer modelo sem aviso prévio e sem que seja motivo de reclamações.

As condições, características e preços dos produtos que aparecem neste catálogo são os vigentes na data de impressão do catálogo salvo erro tipográfico e estão sujeitos a possíveis modificações. Os preços mostrados são preços de venda ao público (PVP).

IVA NÃO INCLUÍDO NA LISTA DE PREÇOS

Lista de preços não é válido para a Itália e Suíça.

Mediante comunicação prévia à Lorefar, apenas se aceitará a mercadoria devolvida por defeito, nunca por vidros partidos ou falta de algum componente. Nestes casos pedimos que entrem em contacto conosco para lhes enviarmos urgentemente as peças requeridas.

Não serão admitidas alterações nem devoluções de mercadoria em bom estado. Em caso de aceitação explícita por parte da Lorefar, na sua recepção e comprovação emitir-se-á um débito de 20% a título de depreciação e classificação da mercadoria.

GER

Die Information über unsere Produkte kann im Zusammenhang mit den Verbesserungen ihrer technischen Eigenschaften und ihres Designs jederzeit geändert werden.

Faro Barcelona behält sich das Recht vor, seine Modelle jederzeit und ohne vorherige Ankündigung vom Markt zu nehmen, ohne dass sich daraus ein Anrecht auf Beschwerden ableiten könnte.

Die Bedingungen, Eigenschaften und Preise der Produkte in diesem Katalog gelten zum Datum der Drucklegung des Katalogs vorbehaltlich Druckfehler und können jederzeit geändert werden. Diese Preise gelten für den Direktverkauf an den Kunden.

DIE MEHRWERTSTEUER IST NICHT IN DEN PREISEN EINGESCHLOSSEN

Preisliste gilt nicht für Italien und die Schweiz.

Nach vorheriger Kommunikation kann Lorefar die Rücklieferung von schadhafter Ware akzeptieren, jedoch niemals wegen beschädigten Glasteilen oder fehlenden Komponenten. In letzteren Fällen setzen Sie sich bitte zwecks schneller Zusendung der notwendigen Teile in Verbindung.

Wir tauschen keine Waren in gutem Zustand um oder nehmen sie zurück. Bei ausdrücklicher Annahme durch Lorefar nach Erhalt und Überprüfung stellen wir Ihnen 20% des Preises für Wertverminderung und Handhabung der Ware in Rechnung.

NL

De informatie over onze producten kan gewijzigd worden met als doel de technische eigenschappen of het design te verbeteren.

Faro Barcelona behoudt zich het recht voor onaangekondigd modellen te schrappen of te wijzigen en zonder dat dit aanleiding tot een klacht vormt.

De voorwaarden, eigenschappen en prijzen van de producten in deze catalogus zijn geldig op het moment van druk van de catalogus tenzij sprake is van een drukfout. Zij zijn onderhevig aan mogelijke wijzigingen. De getoonde prijzen betreffen verkoopprijzen.

Btw NIET BIJ DE PRIJS INBEGREPEN

Tairfa niet geldig voor Italië en Zwitserland.

Lorefar aanvaardt uitsluitend defecte teruggezonden goederen nadat zij hierover van tevoren op de hoogte is gesteld. Dit geldt niet voor gebroken glas of het ontbreken van onderdelen. In deze gevallen wordt u verzocht met ons contact op te nemen zodat wij u zo snel mogelijk de gewenste onderdelen kunnen toezenden.

Ruilen of terugsturen van goederen in correcte staat is niet toegestaan. In geval van uitdrukkelijke aanvaarding door Lorefar wordt bij ontvangst en controle een heffing van 20% voor waardevermindering en classificatie van de goederen toegepast.

I

La informazione che si riferisce ai nostri articoli può essere soggetta a modifiche con il fine di migliorare le caratteristiche, tecniche o di design, dei nostri prodotti. Faro Barcelona si riserva il diritto di annullare o modificare qualsiasi modello senza previo avviso e senza che sia motivo di reclami.

Le condizioni, caratteristiche e prezzi dei prodotti che compaiono in questo catalogo sono quelli vigenti alla data della stampa del catalogo ad eccezione di errori tipografici e sono soggetti a possibili modificazioni.

I prezzi indicati sono prezzi di vendita al pubblico.

IVA NON INCLUSA IN LISTINO.

Il listino non è valido per l'Italia e la Svizzera.

LOREFAR accetta previa comunicazione, solo la merce restituita perché difettosa; in nessun caso accetterà la merce restituita per presenza di verti rotti o per mancanza di qualche componente. In questi casi vi preghiamo di contattarci per potervi mandare al più presto i pezzi richiesti.

Non si effettuano cambi né si ammettono restituzioni di merci in buono stato. In caso di accettazione esplicita da parte di LOREFAR, al momento del ricevimento e della verifica della merce si emetterà un addebito del 20% a titolo di deprezzamento e classificazione.

GRK

Οι πληροφορίες σχετικά με τα προϊόντα μας ενδέχεται να τροποποιηθούν με στόχο τη βελτίωση των τεχνικών χαρακτηριστικών ή του σχεδίου.

Η Faro Barcelona διατηρεί το δικαίωμα ακύρωσης ή τροποποίησης οποιουδήποτε μοντέλου χωρίς προηγούμενη προειδοποίηση και χωρίς αυτό να αποτελεί αιτία απαίτησης επιστροφής χρημάτων.

Οι όροι, τα χαρακτηριστικά και οι τιμές των προϊόντων που παρουσιάζονται σε αυτόν τον κατάλογο είναι αυτά που ισχύουν κατά την ημερομηνία της εκτύπωσης του καταλόγου, εκτός τυπογραφικών λαθών, και υπόκεινται σε αλλαγές. Οι τιμές που εμφανίζονται είναι τιμές λιανικής.

Ο ΦΠΑ ΔΕΝ ΣΥΜΠΕΡΙΛΑΜΒΑΝΕΤΑΙ ΣΤΗΝ ΤΙΜΗ

Μετά από συνεννόηση με τη Lorefar, γίνονται αποδεκτές επιστροφές μόνο αν πρόκειται για ελαττωματικά εμπορεύματα και όχι για θραύση κρυστάλλων ή απουσία κάποιου στοιχείου. Στις περιπτώσεις αυτές, παρακαλούμε να έρθετε σε επαφή μαζί μας για να σας στείλουμε επείγοντως τα απαιτούμενα μέρη.

RUS

Информация относящаяся к нашей продукции может быть модифицирована с целью улучшить технические или внешние характеристики.

Faro Barcelona сохраняет за собой право анулировать или модифицировать любую модель без предупреждения и без того что это послужит причиной для жалоб.

Δεν γίνονται αποδεκτές αλλαγές ή επιστροφές για εμπορεύματα σε καλή κατάσταση. Σε περίπτωση ρητής αποδοχής εκ μέρους της Lorefar, κατά την παραλαβή και τον έλεγχο τους θα πραγματοποιηθεί χρέωση 20% για έξοδα απόσβεσης και ταξινόμησης των εμπορευμάτων. Условия, характеристики и цены на изделия, указанные в данном каталоге, действительны на дату его выпуска, за исключением опечаток в каталоге, и могут быть изменены. В каталоге указаны розничные цены. БЕЗ УЧЕТА НДС

В соответствии с правилами, компания Lorefar принимает возврат изделий только при наличии дефектов, но ни в коем случае не при разбитии стекла или отсутствии какой-либо детали. В таком случае, пожалуйста, свяжитесь с нами, чтобы мы отправили вам необходимые детали.

Товар в рабочем состоянии не подлежит обмену или возврату. В случае подтверждения компанией Lorefar наличия дефектов, после возврата и проверки, начисляется 20% стоимости с учетом амортизации и классификации товаров.

CZ

Technické informace uvedené v katalogu mohou být modifikovány za účelem zdokonalování vlastností svítidel nebo jejich designu.

Producent Faro Barcelona si vyhrazuje právo konstrukčních změn nabízených modelů bez předcházejícího oznámení a tato skutečnost nemůže být předmětem jakékoliv stížnosti či reklamace.

Podmínky, technické specifikace a ceny produktů uvedené v katalogu jsou platné ke dni vydání katalogu. Producent si vyhrazuje právo konstrukčních změn nabízených modelů, pokud tyto nepovedou k zásadním změnám charakteru výrobků. Informace z tohoto katalogu postrádají platnosti v den vydání katalogu nového.

VŠECHNY CENY JSOU UVEDENY BEZ DPH.

Zboží může být vráceno pouze po předchozím souhlasu od společnosti PAXI, na základě poruchy nebo vady ovšem nikdy na základě poškozeného skla nebo chybnějšího dílu. V takových případech nás, prosím, kontaktujte, abychom Vám mohli požadované části svítidel urgentně zaslat. Výměny nebo vrácení zboží v dobrém technickém stavu je nepřijatelné.

BL

Техническата информация, представена в нашият каталог, може да бъде променяна с цел да подобри представянето или дизайна на продуктите. Фаро Барселона си запазва правото да отменя или променя всеки модел без предварително осведомяване и без това да се счита причина за оплаквания.

Условията, техническите характеристики и цените на продуктите показани в този каталог са ефективни към датата на отпечатването на каталога, с изключение на грешки при отпечатване и са обект на възможни промени.

Цените в каталога са публичните цени.

ЦЕНИТЕ НЕ ВКЛЮЧВАТ ДДС.

Връщане на закупена стока ще да бъдат приета единствено след писмено осведомяване на ЛОРЕФАР на основание дефекти и в никакъв случай на основание случено стъкло или липсващи части. В такива случаи моля свържете те с нас, за да ви изпратим липсващите части по спешност. Размяна или връщане на стока в добро състояние няма да бъде извършвана. В случай на спешно приемане от ЛОРЕФАР 20 % такса ще бъде наложена за приемане и проверка, за обезценяване и класификация на продуктите.

PL

Informacje techniczne wyszczególnione w naszym katalogu mogą być modyfikowane w celu poprawienia właściwości lub wzornictwa produktów.

Faro Barcelona ma prawo do anulowania i modyfikowania każdego z modeli bez uprzedniego infomowania i nie przyjmuje skarg z tego tytułu.

Warunki, opis techniczny oraz ceny artykułów, które pojawiają się w katalogu są aktualne do czasu przedruku katalogu za wyjątkiem pomyłek w druku, które podlegają ewentualnej zmianie. Ceny w katalogu są cenami publicznymi.

CENY NIE ZAWIERAJĄ STAWKI VAT.

Ewentualne zwroty mogą być zaakceptowane po uprzedniej zgodzie przez Lorefar na podstawie stwierdzenia, że są wadliwe, nigdy nie przyjmowane są zwroty artykułów, z powodu stłuczenia szkła czy brakujących części, w tym przypadku prosimy o kontakt w celu wysłania potrzebnych części w trybie natychmiastowym.

Wymiany lub zwroty artykułów w dobrym stanie nie będą zaakceptowane. W przypadku wyraźnej akceptacji przez Lorefar, 20% opłaty może być poniesione na otrzymanie i sprawdzenie, w celu sklasyfikowania uszkodzenia artykułu.



Ref.	Pag.	Ref.	Pag.	Ref.	Pag.
02010101	311	19038	377	28399	147
02010104	311	19039	377	28400	219
02010201	311	20000	23	28401	119
02010204	311	20001	23	28406	132
02010301	311	20002	23	28407	132
02010304	311	20003	23	28408	119
02010401	311	20004	23	29003	242
02010404	311	20005	23	29238	147
02090101	289	20006	25	29239	147
02090201	289	20007	25	29293	144
03002	275	20008	25	29294	137
03004	275	20009	21	29295	137
03005	275	20010	25	29296	137
03006	275	20011	25	29297	137
03007	273	20012	25	29300	155
03008	273	20016	21	29306	49
03009	273	20017	21	29307	47
03010	273	20018	21	29308	47
03011	274	20019	21	29309	49
03012	274	20020	21	29310	49
03013	274	20021	27	29311	47
03014	274	20022	27	29312	47
03015	274	20023	27	29313	49
03016	274	20024	27	29468	147
03020	272	20025	28	29664	145
03022	272	20026	28	29764	124
17500	299	20027	29	29789	146
17501	299	20028	29	29793	121
19026	376	20029	29	29796	121
19027	376	20030	29	29830	133
19028	376	28370	115	29830B	133
19029	376	28371	115	29830P	133
19030	376	28380	113	29831	133
19031	377	28381	113	29831 B	133
19032	377	28382	113	29831 P	133
19034	377	28383	113	29850	65
19035	377	28384	113	29851	65
19036	377	28385	113	29853	65
19037	377	28398	147	29854	65

Ref.	Pag.	Ref.	Pag.	Ref.	Pag.
29855	65	29930	50	29974	211
29864	40	29931	50	29975	211
29865	40	29935	36	29976	211
29866	41	29936	37	29977	211
29867	41	29937	39	29980	31
29868	41	29938	39	29981	31
29869	41	29939	37	29982	31
29873	55	29940	33	29983	31
29874	55	29941	33	29984	30
29875	52	29942	35	29985	30
29876	52	29943	35	29991	213
29877	55	29944	32	29992	213
29878	55	29945	33	29993	213
29879	54	29946	33	40010	369
29880	54	29947	35	40011	369
29881	53	29948	35	40062	219
29882	53	29949	32	40070	219
29883	53	29950	36	40100	207
29884	53	29951	36	40101	207
29886	67	29952	37	40160	310
29887	67	29953	37	40215	341
29888	67	29954	39	40225	341
29889	67	29955	39	40271	199
29890	69	29956	37	40272	199
29891	69	29957	37	40273	199
29894	69	29958	39	40391	197
29895	69	29959	39	40393	198
29906	117	29960	42	40394	198
29907	117	29961	42	40395	198
29920	51	29962	43	40396	197
29921	51	29963	43	40397	197
29922	51	29964	43	40411	197
29923	51	29965	43	40421	200
29924	51	29966	45	40422	200
29925	51	29967	45	40423	200
29926	51	29968	45	40425	201
29927	51	29969	45	40426	201
29928	50	29970	43	40427	201
29929	50	29971	43	40550	172



Ref.	Pag.	Ref.	Pag.	Ref.	Pag.
40551	172	40908	193	42855	285
40552	172	40909	193	42856	285
40553	173	40917	224	42857	285
40554	173	40933	221	42858	285
40555	173	40937	225	42859	285
40556	173	40938	189	42860	285
40557	173	40939	189	42861	285
40558	173	40940	189	42862	287
40559	173	40941	191	42863	287
40560	173	40942	191	42864	287
40561	173	40994	223	42865	287
40562	205	40995	223	42866	287
40563	205	40996	223	42867	287
40564	205	41010	185	42868	287
40791	181	41011	185	42869	287
40792	180	41012	185	42870	287
40793	181	41019	223	42871	287
40794	181	41020	223	42872	287
40799	179	41021	223	42873	287
40800	179	41022	223	42874	287
40805	179	41023	221	42875	287
40847	182	41100	177	42876	287
40848	183	41101	177	42877	287
40849	183	41102	177	42905	341
40850	183	41103	175	42906	310
40871	195	41104	175	42910	291
40872	195	41105	175	42911	291
40873	195	42801	311	42912	291
40880	187	42840	283	42913	291
40881	186	42841	283	42918	339
40882	187	42842	283	42919	339
40883	187	42846	285	42921	291
40884	187	42847	285	42922	339
40885	186	42848	285	42923	289
40886	187	42849	285	42924	289
40887	187	42850	285	42925	341
40891	197	42851	285	42926	337
40892	196	42852	285	42927	337
40893	198	42853	285	42970	343
40907	193	42854	285	42971	343

Ref.	Pag.	Ref.	Pag.	Ref.	Pag.
42972	342	43399	301	51901	365
42973	343	43400	301	51902	365
43004A	310	43401	301	51904	369
43016	310	43402	301	51905	369
43050	308	43403	301	51908	359
43051	308	46027	297	51909	359
43053	308	46028	297	51910	359
43056	309	46029	297	51911	359
43057	309	46030	297	51913	361
43058	309	46031	296	51914	361
43059	309	46032	297	51915	361
43065	381	46033	296	51916	359
43070	381	46034	297	51917	359
43071	305	46060	381	51918	359
43072	305	46061	381	51919	359
43200A	309	4R033	381	51960	360
43203A	309	50025	373	51961	360
43204	309	50040	372	51962	360
43210	309	50041	372	51964	360
43211	309	50042	372	51965	360
43215	309	50043	372	51966	361
43216	309	50052	372	51967	361
43217	309	50064	371	51968	361
43300	304	50992	353	51969	361
43301	304	50993	353	51970	361
43306	304	50994	362	51971	361
43307	304	51011	371	51973	357
43315	305	51089	370	51975	357
43316	305	51151	368	52006	369
43326	307	51162	366	52008	369
43328	307	51164	366	52009	369
43382	302	51170	366	52043	365
43383	302	51171	366	52044	365
43384	302	51172	366	52045	365
43386	303	51179	367	52046	365
43388	303	51180	367	52049	363
43389	303	51181	367	52057	355
43396	299	51182	367	52058	355
43397	299	51184	367	52059	355
43398	299	51900	365	52061	355



Ref.	Pag.	Ref.	Pag.	Ref.	Pag.
52064	353	61071	249	63039	329
52065	353	62055	379	63040	245
52076	370	62056	379	63041	245
52081	351	62061	380	63043	325
53413	363	62063	380	63046	247
53414	351	62066	380	63047	247
53415	351	62083	378	63052	270
54006	364	62086	379	63053	246
54007	364	62087	379	63056	269
54008	364	62105	227	63057	269
54009	364	62106	227	63064	247
54010	364	62107	227	63065	247
54011	364	62108	227	63069	243
55018	357	62109	227	63075	266
55019	357	62110	227	63076	266
55190	349	62112	214	63084	269
55191	348	62113	214	63087	268
55192	349	62115	215	63088	268
55193	349	62965	333	63089	268
55204	347	62966	333	63090	246
57049	126	62968	335	63105	245
57068	125	62969	335	63117	261
57069	125	62980	333	63120	325
57200	123	62981	333	63124	263
57201	123	62982	333	63125	263
57202	123	62983	335	63126	263
57205	123	62984	335	63127	263
57206	123	62985	335	63128	263
57207	123	62986	246	63129	263
61005	265	62987	246	63146	327
61006	265	62988	217	63147	319
61008	269	63007	330	63148	319
61046	225	63008	327	63151	243
61047	225	63009	327	63153	271
61048	249	63010	268	63156	244
61049	249	63011	268	63157	271
61064	251	63012	268	63158	271
61066	251	63027	243	63167	231
61068	251	63028	267	63172	239
61070	249	63038	325	63173	239

Ref.	Pag.	Ref.	Pag.	Ref.	Pag.
63174	239	63285	235	64152	160
63175	238	63286	293	64153	160
63176	237	63288	235	64154	160
63177	237	63289	292	64159	161
63178	237	63290	293	64160	161
63186	233	63302C	331	64161	161
63187	217	63303C	331	64162	161
63191	217	63304C	331	64170	139
63199	231	63309	267	64172	139
63200	232	63310	267	64175	153
63201	233	63320	321	64176	145
63202	233	63321	321	64177	317
63203	319	63322	323	64178	317
63215	257	63323	323	64180	57
63216	256	63324	323	64181	57
63217	257	63325	315	64182	57
63218	257	63326	315	64183	57
63219	159	63398	265	64184	59
63220	159	63399	329	64185	59
63230	265	63401	329	64186	59
63231	221	63403	328	64187	59
63232	221	64100	164	64190	259
63236	259	64101	165	64191	159
63237	259	64102	165	64192	205
63238	257	64104	167	64198	260
63239	256	64108	166	64199	260
63240	257	64109	165	64200	261
63270	255	64120	169	64201	261
63271	255	64125	167	64202	206
63272	255	64129	167	64203	206
63273	255	64131	169	64210	207
63274	254	64132	163	64211	207
63275	254	64133	63	64212	207
63276	255	64134	63	64213	207
63277	255	64137	141	64214	207
63280	293	64139	149	64215	207
63281	295	64140	163	65071	141
63282	295	64141	163	65133	63
63283	295	64142	163	65136	262
63284	235	64145	149	65137	262



Ref.	Pag.	Ref.	Pag.	Ref.	Pag.
66091	107	67018	85	68531	79
66092	107	67019	84	68532	77
66093	109	67020	85	68533	77
66094	109	68138	103	68535	153
66095	108	68139	103	68544	91
66130	105	68144	143	68545	91
66132	104	68153	155	68546	92
66133	105	68283	151	68547	91
66134	105	68284	151	68548	93
66137	241	68285	151	68549	93
66177	95	68286	151	68558	131
66178	95	68312	129	68559	131
66179	94	68313	129	68561	143
66183	241	68333	120	68570	61
66184	241	68334	120	68571	61
66185	241	68396	128	68573	61
66186	241	68417	83	68574	61
66187	240	68418	83	68576	61
66190	98	68419	81	68577	61
66191	101	68420	81	71363	231
66192	101	68422	121	71366	231
66193	100	68423	121	71367	231
66194	99	68432	279	71526	229
66195	99	68433	278	71527	229
66200	97	68434	279	75509	228
66201	97	68461	149	75510	228
66204	96	68462	127	75511	228
66205	97	68463	127	98310589	283
66872	150	68500	73	98310689	283
66873	150	68501	73		
67000	277	68502	73		
67001	276	68503	73		
67002	277	68504	71		
67005	86	68505	71		
67006	87	68506	71		
67007	87	68507	71		
67008	89	68513	75		
67009	89	68514	75		
67016	157	68515	74		
67017	157	68530	79		



Mod	Pag.	Mod	Pag.	Mod	Pag.
acaCia	269	ceLia	219	foNt <small>[new]</small>	285
adrA	266	chApí	121	fuJi	265
akanE	114	chEras	238	galAxia	180
aladiNo	360	ciLo	165	gaLileo	370
álAmo	189	clEan	329	geNaker	242
aldEr	163	clOe <small>[new]</small>	328	giGi <small>[new]</small>	61
aliCe <small>[new]</small>	61	clon	378	giNa	231
Ally	219	coCcote <small>[new]</small>	56	grOe	235
alumiNio	164	cOde	229	gRu	359
aMbo	232	conO	241	halCón	272
aMi <small>[new]</small>	265	coPic	259	hAlita <small>[new]</small>	141
áNgulo	243	cOra	330	hAlo	348
anoUk <small>[new]</small>	351	cráTer	149	haNs	145
aRgón <small>[new]</small>	301	crEta	74	hAt	119
aRiel	361	dAllas <small>[new]</small>	231	hElío	307
aRt	141	danA	341	heNlein	251
aSpa	278	daNte	269	hEnri	217
auRea <small>[new]</small>	215	dAta	246 y 268	homS	231
aZor	273	dEgas	249	hotel	32
baBá	357	diAne <small>[new]</small>	61	ibiScus	243 y 271
baNker	120	dinO	269	ikOn	315
baObab	359	diuLa	246	iNdo	327
bAr	163	dlx	132	jaNet <small>[new]</small>	262
baTh-3	339	dokA	323	kAlen	121
biRd	228	dOt	289	kaLO	276
bLack	124	dRaco	193	kanT	341
bLAt	185	eAco	237	KaO <small>[new]</small>	329
bLiss	119	eBba	339	kaPa	221
blisTer ledStrip	376	elbA	363	kiT GU 10	309
bOb	365	eMma	310	kiT GU 10 LED	309
bOden	331	eQui	246	kiT MR 16	309
boNgo	166	eRis	177	kiT MR 16 LED	309
boReal	179	eVa	342	kLimt	249
bugAtti	224	fiJo	308	kOi	291
caBi	379	flAt	283	lampetta	64
caLda	319	flexi	50	laMpi	380
carRé	310	flUo	380	laoS	321

Mod	Pag.	Mod	Pag.	Mod	Pag.
laRa <small>[new]</small>	84	mOma	70	pérgAmo	154
lásEr	371	mONet <small>[new]</small>	251	pEtra	219
lAss	327	moNt <small>[new]</small>	287	plAno	302
Lea	373	moNtana	126	pLas	295
led miNi	291	móVil	309	plAtillo	165
ledStrip	376	mulAn	365	plaTón	311
lenA <small>[new]</small>	355	mUrano	144	pLot <small>[new]</small>	206
lEni	265	nAn <small>[new]</small>	159, 205 y 259	pLuma	138
leNte	371	naNko	149	porTos	245
lEO	363	náPoles	104	pOte	263
liChi	261	naRa	339	proSa	153
liLium	128	nEón <small>[new]</small>	301	quArk	310
liLY	369	neRis	225	quaSar	341
linda	46	nEu	293	quO	94
link	52	neutrÓN	305	rAdón <small>[new]</small>	299
liRia	244 y 271	nExo	122	rAm <small>[new]</small>	207
liSe <small>[new]</small>	66	niDia	121	raY	225
loGos	333	nIdo	155	reL <small>[new]</small>	260
loKe <small>[new]</small>	223	nIger	325	reLax	325
lUce <small>[new]</small>	145	niOBe	370	retro <small>[new]</small>	20
lUla	112	nitrO	167	riMa	353
luMiere	251	nOble	133	riNg <small>[new]</small>	172 y 205
luNe	200	nOrd <small>[new]</small>	293	rlo	86
lUx	311	nuDos	102	roDa	217
maGma	146	nuKa <small>[new]</small>	364	rOma	125
maGni	372	nUsa	289	ronDa	267
mAket	372	Ola	247	rOom <small>[new]</small>	210
maLi	150	óLEo	167	sAba	90
maLmo <small>[new]</small>	292	oNa <small>[new]</small>	351	saBana	212
maRgot <small>[new]</small>	143	ónIce	304	sac	98
mArLin <small>[new]</small>	62	oRa	68	Sam	369
meRlín	369	osLo <small>[new]</small>	235	sAmi <small>[new]</small>	221
miA	153	oTto <small>[new]</small>	353	sElene	366
miKa	186	oVo <small>[new]</small>	226	sEven	151
miLD	315	pAm	161	siNki	217
miTic	80	paPillon <small>[new]</small>	136	siNtra	245
mix	42	papUa	127	sirEt <small>[new]</small>	317



Mod	Pag.	Mod	Pag.
siRia	167	vOlta [new]	26
siSmo	147	winch	96
sNow [new]	235	yAp	357
sOul	131	yEs	293
sQuad	159 y 256	yeTi	362
sTar	195	yUca	268 y 329
sunNy	247	yUri	175
sWan	347	zlrcón	305
sweet	36		
swiNg [new]	214		
tavErn	143		
teCto [new]	255		
teCto AR III [new]	254		
tEd [new]	337		
teMpo	160		
teR	368		
teRma	319		
tHana	76		
tHym	157		
tiDa	270		
timbaL	169		
tiMe	319		
tirSo	296		
tOd [new]	337		
tOla	335		
toRino	106		
tranSfer	169		
tree	40		
tuB	221		
tubA	182		
tuRbo	199		
Twin	240		
uNit [new]	379		
veGa	310		
veRa	243 y 267		
versUs	116		
vesper	30		

LOREFAR
c/Dinámica, 1
08755 Castellbisbal
Barcelona, Spain
faro@lorefar.com
www.faro.es

Tel. Comercial
902 165 166
Fax. Comercial
937 720 018

Tel. Export
+34 937 723 965
Fax. Export
+34 937 723 967