

	X	Y	W	Z
PC952	400	300	300	

Identification

Name	WHISTLE SMALL
Type	suspension lamp
Collection	WHISTLE
Line	Exclusive Line
Designed by	Lucie Koldová

BROKIS

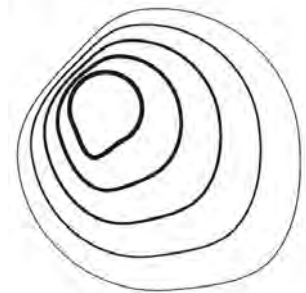

Description

Features

Suspension Whistle lamp constitutes a symbiosis of two different forms or their multiplication. As the external shape is following the ray of light, it symbolically portrays the shape of traditional whistles. This design follows a series of lamps made of transparent glass with a more technical appearance. Inserted spot lamp is highlighted by offset inks, outer form creates an impression of the shade of an internal soul of the pendant and further define the precise shape of elongated pipes. Hand-blown objects create a visual line of archetypal lights directing light downwards. Whistle lamp collection consists of three glass pipes of larger dimensions and showcases the mastery of the material and the Czech glassmakers.

Technology

The craftsmanship applied in production follows in the centuries-old tradition and experience of master glassmakers. The precision crafting of hand-blown glass instills distinctive, enduring character and outstanding quality in all Brokis products. The glass shades are formed from multiple layers of molten glass, each of which is scrutinized by the master glassmaker prior to being blown into the mold. Up to 70% of the resulting quality is achieved in this stage of production. The metal reflector is manufactured through a unique metal stamping technique that has been proven over the course of millennia and involves spinning cold sheet metal on a rotating form. The history of this technology goes back to Celtic times. As with the glassmakers, the master metalworkers draw upon the tradition and experience that have been carefully passed down through the ages and give the final product exceptional added value.

Product Classification

Name	WHISTLE	SMALL	
Colour	BAS	smoke arev transparent	CGC516 CGC23
SurfaceG	ALL	glossv	CGSU66
SurfaceC	BAS	white black magenta menthol arev	CCS575 CCS582 CCS724 CCS723 CCS720
Bulbs	ALL	bulb ax53. 7.5W. 500lm. 2700K	CEB717
Cable colour	BAS	white black magenta menthol arev	CECL521 CECL519 CECL726 CECL725 CECL520
Certification	ALL	CE EN 60598-1 EN 60598-2-4	CEC160 CEC569 CEC570

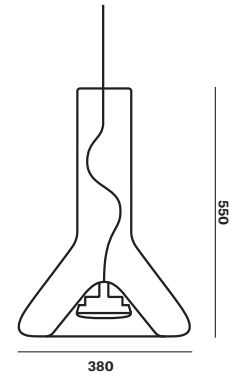

	X	Y	W	Z
PC953	380	550		

Identification

Name	WHISTLE MEDIUM
Type	suspension lamp
Collection	WHISTLE
Line	Exclusive Line
Designed by	Lucie Koldová

BROKIS

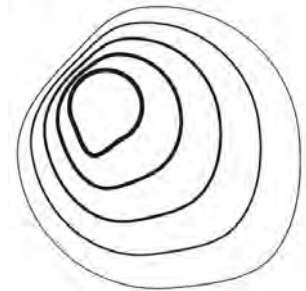

Description

Features

Suspension Whistle lamp constitutes a symbiosis of two different forms or their multiplication. As the external shape is following the ray of light, it symbolically portrays the shape of traditional whistles. This design follows a series of lamps made of transparent glass with a more technical appearance. Inserted spot lamp is highlighted by offset inks, outer form creates an impression of the shade of an internal soul of the pendant and further define the precise shape of elongated pipes. Hand-blown objects create a visual line of archetypal lights directing light downwards. Whistle lamp collection consists of three glass pipes of larger dimensions and showcases the mastery of the material and the Czech glassmakers.

Technology

The craftsmanship applied in production follows in the centuries-old tradition and experience of master glassmakers. The precision crafting of hand-blown glass instills distinctive, enduring character and outstanding quality in all Brokis products. The glass shades are formed from multiple layers of molten glass, each of which is scrutinized by the master glassmaker prior to being blown into the mold. Up to 70% of the resulting quality is achieved in this stage of production. The metal reflector is manufactured through a unique metal stamping technique that has been proven over the course of millennia and involves spinning cold sheet metal on a rotating form. The history of this technology goes back to Celtic times. As with the glassmakers, the master metalworkers draw upon the tradition and experience that have been carefully passed down through the ages and give the final product exceptional added value.

Product Classification

Name	WHISTLE	MEDIUM	
Colour	BAS	smoke arev transparent	CGC516 CGC23
SurfaceG	ALL	glossv	CGSU66
SurfaceC	BAS	white black magenta menthol arev	CCS575 CCS582 CCS724 CCS723 CCS720
Bulbs	ALL	bulb ax53. 7.5W. 500lm. 2700K	CEB717
Cable colour	BAS	white black magenta menthol arev	CECL521 CECL519 CECL726 CECL725 CECL520
Certification	ALL	CE EN 60598-1 EN 60598-2-4	CEC160 CEC569 CEC570

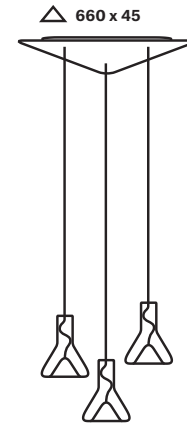

	X	Y	W	Z
PC961		2000		660

Identification

Name	WHISTLE
	-
Type	suspension lamp
Collection	WHISTLE
Line	Exclusive Line
Designed by	Lucie Koldová

BROKIS

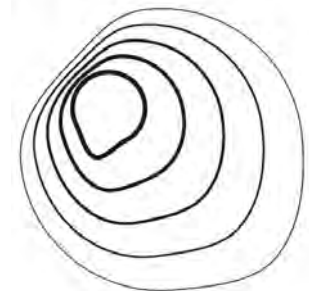

Description

Features	<p>Set of three Whistle with the triangle metal canopy.</p> <p>Suspension Whistle lamp constitutes a symbiosis of two different forms or their multiplication. As the external shape is following the ray of light, it symbolically portrays the shape of traditional whistles. This design follows a series of lamps made of transparent glass with a more technical appearance. Inserted spot lamp is highlighted by offset inks, outer form creates an impression of the shade of an internal soul of the pendant and further define the precise shape of elongated pipes. Hand-blown objects create a visual line of archetypal lights directing light downwards. Whistle lamp collection consists of three glass pipes of larger dimensions and showcases the mastery of the material and the Czech glassmakers.</p>
-----------------	---

Technology	<p>The craftsmanship applied in production follows in the centuries-old tradition and experience of master glassmakers. The precision crafting of hand-blown glass instills distinctive, enduring character and outstanding quality in all Brokis products. The glass shades are formed from multiple layers of molten glass, each of which is scrutinized by the master glassmaker prior to being blown into the mold. Up to 70% of the resulting quality is achieved in this stage of production. The metal reflector is manufactured through a unique metal stamping technique that has been proven over the course of millennia and involves spinning cold sheet metal on a rotating form. The history of this technology goes back to Celtic times. As with the glassmakers, the master metalworkers draw upon the tradition and experience that have been carefully passed down through the ages and give the final product exceptional added value.</p>
-------------------	--

Product Classification

Name	WHISTLE	-	
Colour	BAS	smoke arev transparent	CGC516 CGC23
SurfaceG	ALL	glossv	CGSU66
SurfaceC	BAS	white black magenta menthol arev	CCS575 CCS582 CCS724 CCS723 CCS720
Bulbs	ALL	bulb ax53. 7.5W. 500lm. 2700K	CEB717
Cable colour	BAS	white black magenta menthol arev	CECL521 CECL519 CECL726 CECL725 CECL520
Certification	ALL	CE EN 60598-1 EN 60598-2-4	CEC160 CEC569 CEC570



	X	Y	W	Z
PC938	390	2200	380	

Identification

Name	MONA PENDENT
Type	suspension lamp
Collection	MONA
Line	Exclusive Line
Designed by	Lucie Koldová

BROKIS

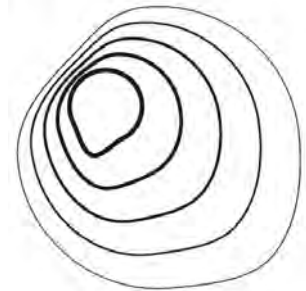

Description

Features

Futuristic bell-shaped Mona lamp exemplifies a sensitive beauty of smooth glass and soft curves. Light daringly pierces the delicate body of the lamp and illuminates the design's thrilling tension, while the artist's distinctive style is reflected in the unexpected combination of wood, textile, and blown glass. The shade and lanyard suspension straps are affixed to the LED light source with a pair of elegant wooden buttons.

Technology

Combined craftsmanship / hand-blown glass in combination with oak and metal body. The craftsmanship applied in production follows in the centuries-old tradition and experience of master glassmakers. The precision crafting of hand-blown glass instills distinctive, enduring character and outstanding quality in all Brokis products. The glass shades are formed from multiple layers of molten glass, each of which is scrutinized by the master glassmaker prior to being blown into the mold. Up to 70% of the resulting quality is achieved in this stage of production.

Product Classification

Name	MONA	PENDENT	
Colour	ALL	black - transparent opaline smoke grey transparent	CGC602 CGC38 CGC516 CGC23
SurfaceG	ALL	glossv	CGSU66
SurfaceC	ALL	European Oak tinted white European Oak natural waxed European Oak - tinted black European Oak - un - treated textile straps - white textile straps - black	CCS680 CCS518 CCS592 CCS657 CCS679 CCS678
	EXT	textile straps white /1m/ + transparent cable textile straps black /1m/ + transparent cable	CCS707 CCS667
Bulbs	ALL	LED 15W, neutral white, 4500K, 800lm LED 15W, cool white, 6000K, 850lm LED 15W warm white, 3000K, 760lm	CEB712 CEB711 CEB710
	STA	DIM - 1-4 channels, remote control DIM - 1-10 channels, remote control	CEB708 CEB709
Certification	ALL	CE EN 60598-1 EN 60598-2-1	CEC160 CEC567 CEC568

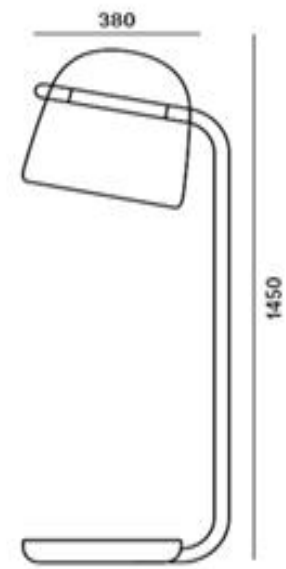

	X	Y	W	Z
PC949	390	1450	380	380

Identification

Name	MONA FLOOR
Type	floor lamp
Collection	MONA
Line	Exclusive Line
Designed by	Lucie Koldová

BROKIS

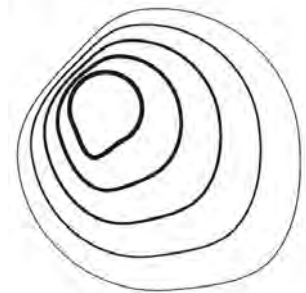

Description

Features

Futuristic bell-shaped Mona lamp exemplifies a sensitive beauty of smooth glass and soft curves. Light daringly pierces the delicate body of the lamp and illuminates the design's thrilling tension, while the artist's distinctive style is reflected in the unexpected combination of wood, textile, and blown glass. The shade and lanyard suspension straps are affixed to the LED light source with a pair of elegant wooden buttons.

Technology

Combined craftsmanship / hand-blown glass in combination with oak and metal body
The craftsmanship applied in production follows in the centuries-old tradition and experience of master glassmakers. The precision crafting of hand-blown glass instills distinctive, enduring character and outstanding quality in all Brokis products. The glass shades are formed from multiple layers of molten glass, each of which is scrutinized by the master glassmaker prior to being blown into the mold. Up to 70% of the resulting quality is achieved in this stage of production.

Product Classification

Name	MONA	FLOOR	
Colour	ALL	black - transparent opaline smoke grey transparent	CGC602 CGC38 CGC516 CGC23
SurfaceG	ALL	glossv	CGSU66
SurfaceC	BAS	European Oak tinted white European Oak - tinted black Alluminium base - white Alluminium base - black Alluminium tube - white Alluminium tube - black	CCS680 CCS592 CCS732 CCS727 CCS734 CCS733
Bulbs	ALL	LED 15W. neutral white. 4500K. 800lm LED 15W. cool white. 6000K. 850lm LED 15W warm white. 3000K. 760lm	CEB712 CEB711 CEB710
Certification	ALL	CE EN 60598-1 EN 60598-2-1	CEC160 CEC567 CEC568

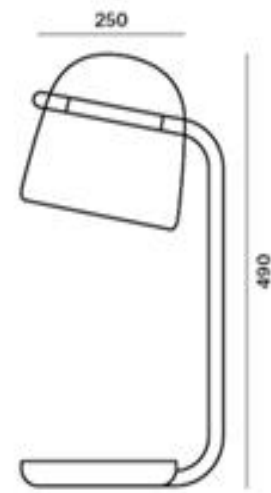

	X	Y	W	Z
PC950	200	490	195	250

Identification

Name	MONA MINI TABLE
Type	table lamp
Collection	MONA
Line	Exclusive Line
Designed by	Lucie Koldová

BROKIS

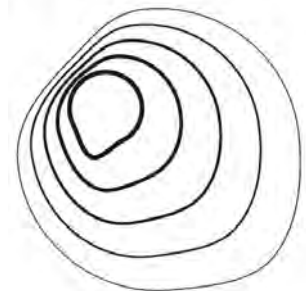

Description

Features

Futuristic bell-shaped Mona lamp exemplifies a sensitive beauty of smooth glass and soft curves. Light daringly pierces the delicate body of the lamp and illuminates the design's thrilling tension, while the artist's distinctive style is reflected in the unexpected combination of wood, textile, and blown glass. The shade and lanyard suspension straps are affixed to the LED light source with a pair of elegant wooden buttons.

Technology

Combined craftsmanship / hand-blown glass in combination with oak and metal body. The craftsmanship applied in production follows in the centuries-old tradition and experience of master glassmakers. The precision crafting of hand-blown glass instills distinctive, enduring character and outstanding quality in all Brokis products. The glass shades are formed from multiple layers of molten glass, each of which is scrutinized by the master glassmaker prior to being blown into the mold. Up to 70% of the resulting quality is achieved in this stage of production.

Product Classification

Name	MONA	MINI TABLE	
Colour	ALL	black - transparent opaline smoke grey transparent	CGC602 CGC38 CGC516 CGC23
SurfaceG	ALL	glossv	CGSU66
SurfaceC	ALL	Alluminium tube - white Alluminium tube - black	CCS734 CCS733
	BAS	Alluminium base - white Alluminium base - black	CCS732 CCS727
	STA	European Oak - tinted white base European Oak - tinted black base	CCS735 CCS736
Bulbs	ALL	LED 8W, neutral white, 4500K, 430lm LED 8W, cool white, 6000K, 460lm LED 8W, warm white, 3000K, 410lm	CEB737 CEB738 CEB739
Certification	ALL	CE EN 60598-1 EN 60598-2-1	CEC160 CEC567 CEC568

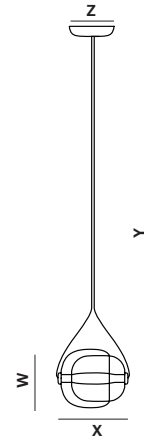

	X	Y	W	Z
PC937	295	2000	265	240

Identification

Name	Capsula -
Type	suspension lamp
Collection	Capsula
Line	Exclusive Line
Designed by	Lucie Koldová

BROKIS

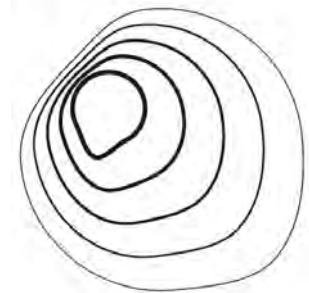

Description

Features

The Capsula model is a brilliant pendant light design composed of two convex capsules, one overlapping the other and fusing into a singular form. The design resembles cells or plant seeds and evokes the metaphor of light as the source of life. The combination of a crystal-clear glass outer shell and an internal capsule of colored glass gives rise to an exciting 3D optical effect, while the tubular LED light source casts soft and gentle illumination throughout any interior.

Technology

The craftsmanship applied in production follows in the centuries-old tradition and experience of master glassmakers. The precision crafting of hand-blown glass instills distinctive, enduring character and outstanding quality in all Brokis products. The glass shades are formed from multiple layers of molten glass, each of which is scrutinized by the master glassmaker prior to being blown into the mold. Up to 70% of the resulting quality is achieved in this stage of production. No less attention to detail is paid in handcrafting the wooden elements of the light. Each piece is individually processed by the artisan in a series of strictly observed production stages. We take special care in selecting quality fine wood and ecologically friendly materials to treat it with.

Product Classification

Name	Capsula	-	
Colour	ALL	smoke grey transparent	CGC516 CGC23
Colour of the inner glass	ALL	amber violet - transparent smoke grey dark smoke grey transparent yellow - transparent	CGC1686 CGC1683 CGC1685 CGC1684 CGC1682 CGC1681
SurfaceG	ALL	glossy	CGSU66
SurfaceC	ALL	European Oak - tinted black	CCS592
Bulbs	ALL ADD	LED 15W, neutral white, 4500K, 800lm LED 15W, cool white, 6000K, 850lm LED 15W warm white, 3000K, 760lm DIM - 1-4 channels, remote control DIM - 1-10 channels, remote control	CEB688 CEB694 CEB661 CEB708 CEB709
Cable colour	ALL	black	CECL519
Certification	ALL	CE EN 60598-1 EN 60598-2-1	CEC160 CEC567 CEC568

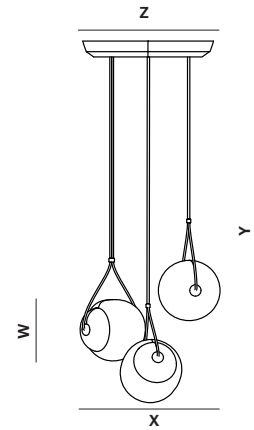

	X	Y	W	Z
PC943	650	2000	265	580

Identification

Name	Capsula TRIANGLE
Type	suspension lamp
Collection	Capsula
Line	Exclusive Line
Designed by	Lucie Koldová

BROKIS

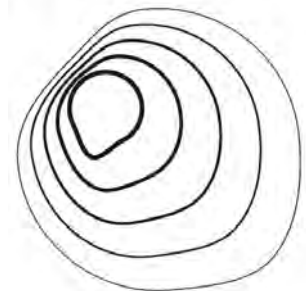

Description

Features	<p>Set of three Capsula with the triangle canopy from the European Oak.</p> <p>The Capsula model is a brilliant pendant light design composed of two convex capsules, one overlapping the other and fusing into a singular form. The design resembles cells or plant seeds and evokes the metaphor of light as the source of life. The combination of a crystal-clear glass outer shell and an internal capsule of colored glass gives rise to an exciting 3D optical effect, while the tubular LED light source casts soft and gentle illumination throughout any interior.</p>
Technology	<p>The craftsmanship applied in production follows in the centuries-old tradition and experience of master glassmakers. The precision crafting of hand-blown glass instills distinctive, enduring character and outstanding quality in all Brokis products. The glass shades are formed from multiple layers of molten glass, each of which is scrutinized by the master glassmaker prior to being blown into the mold. Up to 70% of the resulting quality is achieved in this stage of production. No less attention to detail is paid in handcrafting the wooden elements of the light. Each piece is individually processed by the artisan in a series of strictly observed production stages. We take special care in selecting quality fine wood and ecologically friendly materials to treat it with.</p>

Product Classification

Name	Capsula	TRIANGLE
Colour	ALL	smoke arev transparent CGC516 CGC23
Colour of the inner glass	ALL	amber violet - transparent smoke arev dark smoke arev transparent yellow - transparent CGC1686 CGC1683 CGC1685 CGC1684 CGC1682 CGC1681
SurfaceG	ALL	glossv CGSU66
SurfaceC	ALL	European Oak - tinted black CCS592
Bulbs	ALL	LED 15W. neutral white. 4500K. 800lm LED 15W. cool white. 6000K. 850lm LED 15W warm white. 3000K. 760lm CEB688 CEB694 CEB661
	ADD	DIM - 1-4 channels. remote control DIM - 1-10 channels. remote control CEB708 CEB709
Cable colour	ALL	black CECL519
Certification	ALL	CE EN 60598-1 EN 60598-2-1 CEC160 CEC567 CEC568

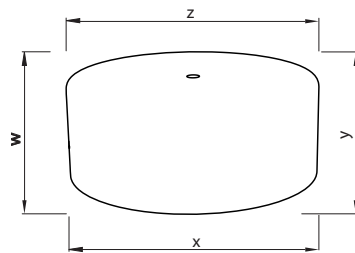

	x	y	w	z
PC944		50		240

Identification

Name	Capsula WOOD CANOPY
Type	accessories
Collection	Capsula
Line	Exclusive Line
Designed by	Lucie Koldová

BROKIS

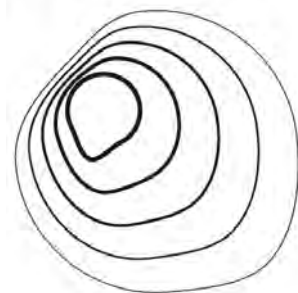

Description

Features	Wooden canopy used for hanging lights CAPSULA, adapted for the installation of electrical wiring in the USA.
-----------------	--

Technology

Product Classification

Name

Capsula

WOOD CANOPY

SurfaceC

ALL

European Oak - tinted black

CCS592

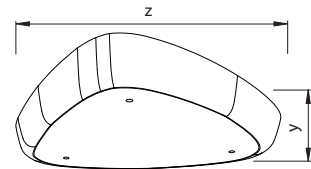

	X	Y	W	Z
PC945		70		495

Identification

Name	Capsula WOOD CANOPY
Type	accessories
Collection	Capsula
Line	Exclusive Line
Designed by	Lucie Koldová

BROKIS

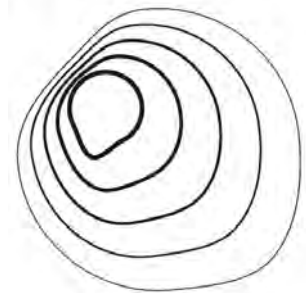

Description

Features	Triangle canopy for set of three Capsula from european oak.
-----------------	---

Technology

Product Classification

Name

Capsula

WOOD CANOPY TRIANGLE

SurfaceC

ALL

European Oak - tinted black

CCS592

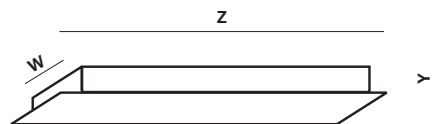
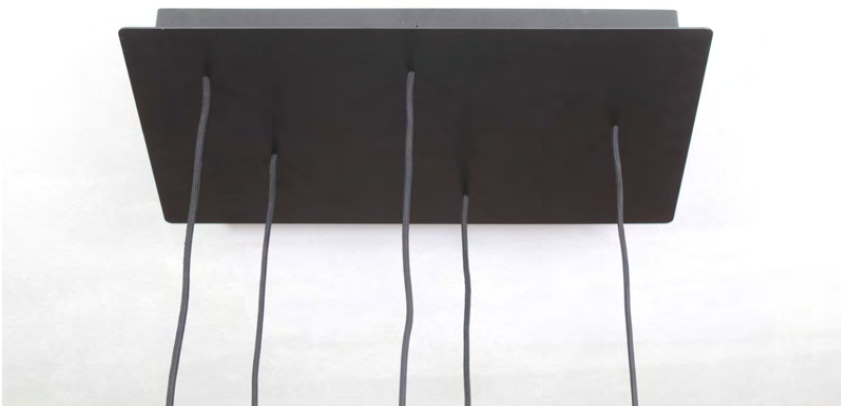

X	Y	W	Z
PC930	53	360	600

Identification

Name SHADOWS
RECTANGULAR SMALL

BROKIS

Type accessories
Collection SHADOWS
Line Exclusive Line
Designed by Lucie Koldová, Dan Yeffet

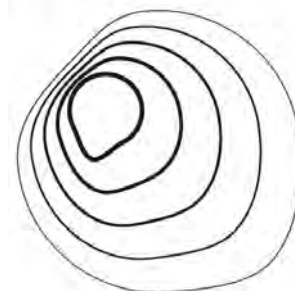

Description

Features Rectangular metal canopy used for hanging one set of Shadows (1 set = 5 lamps Shadows). We offer two colors.

Technology

Product Classification

Name

SHADOWS

RECTANGULAR SMALL

SurfaceC

ALL

iron part -white matt powder coating
iron part - black matt powder coating

CCS618
CCS619

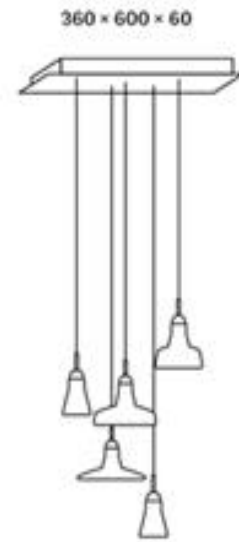

	X	Y	W	Z
PC931	280	2000	170	600

Identification

Name SHADOWS
SET RECTANGULAR

BROKIS

Type suspension lamp
Collection SHADOWS
Line Exclusive Line
Designed by Lucie Koldová, Dan Yeffet

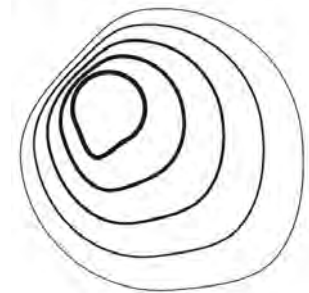

Description

Features Set with a rectangular metal canopy is designed to hang a total of 5 lamps of Shadows

Paying homage to its typological heritage, the Shadows collection is a new take on the recognized and timeless French atelier pendant spot light. The five-lamp clusters feature different types of glass shade that slide over a wooden neck. The variable fittings allow you to apply your own creativity in composing new lighting experiences every day, while the purity of form is underscored by the hidden light source – a warm LED spotlight.

Technology

The craftsmanship applied in production follows in the centuries-old tradition and experience of master glassmakers. The precision crafting of hand-blown glass instills distinctive, enduring character and outstanding quality in all Brokis products. The glass shades are formed from multiple layers of molten glass, each of which is scrutinized by the master glassmaker prior to being blown into the mold. Up to 70% of the resulting quality is achieved in this stage of production. No less attention to detail is paid in handcrafting the wooden elements of the light. Each piece is individually processed by the artisan in a series of strictly observed production stages. We take special care in selecting quality fine wood and ecologically friendly materials to treat it with.

Product Classification

Name	SHADOWS	SET RECTANGULAR CANOPY
Colour	BAS	triplex opal CGC39
	STA	black - transoarent CGC602 black - triplex opal CGC36 smoke brown CGC538 opaline CGC38 smoke arev CGC516 transoarent CGC23
SurfaceG	ALL	glossv CGSU66 acid-etched CGSU67
	SurfaceC	ALL security lock white CCS668 security lock black CCS669
Bulbs	BAS	European Oak natural waxed CCS518 European Oak - tinted black CCS592 European Oak - un - treated CCS657 iron part -white matt powder coating CCS618 iron part - black matt powder coating CCS619
	ALL	bulb LED - WW, 4W, E14, 85-260V CEB641 bulb DIM LED - CW, 4W, E14, 85-260V CEB642
Cable colour	ALL	white CECL521 black CECL519 red CECL530 arev CECL520 yellow CECL606
	EXT	textile cable white /1m/- 3x0,75 CECL713 textile cable black /1m/- 3x0,75 CECL704 textile cable red /1m/- 3x0,75 CECL715 textile cable arev /1m/- 3x0,75 CECL716 textile cable yellow /1m/- 3x0,75 CECL714
Certification	ALL	CE CEC160 EN 60598-1 CEC567 EN 60598-2-1 CEC568

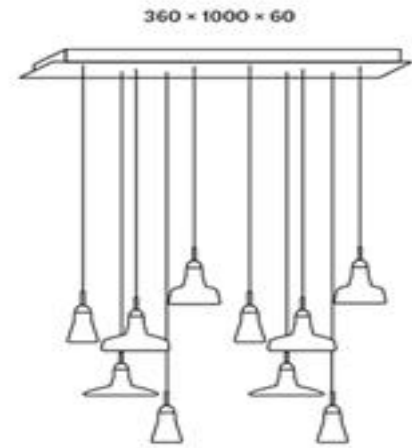

	X	Y	W	Z
PC921	280	2250	170	1000

Identification

Name	SHADOWS SET RECTANGULAR
Type	suspension lamp
Collection	SHADOWS
Line	Exclusive Line
Designed by	Lucie Koldová, Dan Yeffet

BROKIS

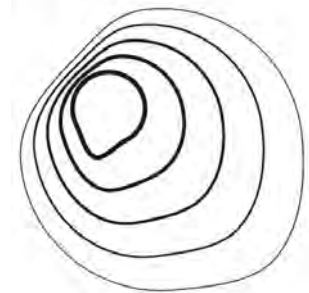

Description

Features	Set with a rectangular metal canopy is designed to hang a total of 10 lamps of Shadows. Paying homage to its typological heritage, the Shadows collection is a new take on the recognized and timeless French atelier pendant spot light. The five-lamp clusters feature different types of glass shade that slide over a wooden neck. The variable fittings allow you to apply your own creativity in composing new lighting experiences every day, while the purity of form is underscored by the hidden light source – a warm LED spotlight.
-----------------	---

Technology

The craftsmanship applied in production follows in the centuries-old tradition and experience of master glassmakers. The precision crafting of hand-blown glass instills distinctive, enduring character and outstanding quality in all Brokis products. The glass shades are formed from multiple layers of molten glass, each of which is scrutinized by the master glassmaker prior to being blown into the mold. Up to 70% of the resulting quality is achieved in this stage of production. No less attention to detail is paid in handcrafting the wooden elements of the light. Each piece is individually processed by the artisan in a series of strictly observed production stages. We take special care in selecting quality fine wood and ecologically friendly materials to treat it with.

Product Classification

Name	SHADOWS	SET RECTANGULAR CANOPY
Colour	BAS	triplex opal CGC39
	STA	black - transoarent CGC602 black - triplex opal CGC36 smoke brown CGC538 opaline CGC38 smoke arev CGC516 transoarent CGC23
SurfaceG	ALL	glossv CGSU66 acid-etched CGSU67
	SurfaceC	ALL security lock white CCS668 security lock black CCS669
Bulbs	BAS	European Oak natural waxed CCS518 European Oak - tinted black CCS592 European Oak - un - treated CCS657 iron part -white matt powder coating CCS618 iron part - black matt powder coating CCS619
	ALL	bulb LED - WW, 4W, E14, 85-260V CEB641 bulb DIM LED - CW, 4W, E14, 85-260V CEB642
Cable colour	ALL	white CECL521 black CECL519 red CECL530 arev CECL520 yellow CECL606
	EXT	textile cable white /1m/- 3x0,75 CECL713 textile cable black /1m/- 3x0,75 CECL704 textile cable red /1m/- 3x0,75 CECL715 textile cable arev /1m/- 3x0,75 CECL716 textile cable yellow /1m/- 3x0,75 CECL714
Certification	ALL	CE CEC160 EN 60598-1 CEC569 EN 60598-2-1 CEC568

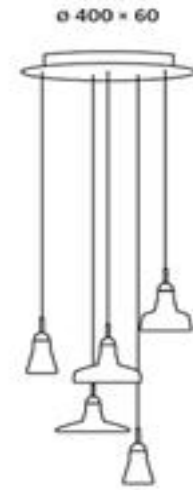

	X	Y	W	Z
PC929	280	2000	170	400

Identification

Name

**SHADOWS
SET RING CANOPY**

BROKIS

Type

suspension lamp

Collection

SHADOWS

Line

Exclusive Line

Designed by

Lucie Koldová, Dan Yeffet

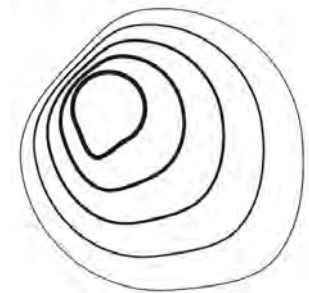

Description

Features

Set with a round metal canopy is designed to hang a total of 5 lamps of Shadows.

Paying homage to its typological heritage, the Shadows collection is a new take on the recognized and timeless French atelier pendant spot light. The five-lamp clusters feature different types of glass shade that slide over a wooden neck. The variable fittings allow you to apply your own creativity in composing new lighting experiences every day, while the purity of form is underscored by the hidden light source – a warm LED spotlight.

Technology

The craftsmanship applied in production follows in the centuries-old tradition and experience of master glassmakers. The precision crafting of hand-blown glass instills distinctive, enduring character and outstanding quality in all Brokis products. The glass shades are formed from multiple layers of molten glass, each of which is scrutinized by the master glassmaker prior to being blown into the mold. Up to 70% of the resulting quality is achieved in this stage of production. No less attention to detail is paid in handcrafting the wooden elements of the light. Each piece is individually processed by the artisan in a series of strictly observed production stages. We take special care in selecting quality fine wood and ecologically friendly materials to treat it with.

Product Classification

Name	SHADOWS	SET RING CANOPY	
Colour	BAS	triplex opal	CGC39
	STA	black - transoarent	CGC602
		black - triplex opal	CGC36
		smoke brown	CGC538
		opaline	CGC38
		smoke arev	CGC516
		transoarent	CGC23
SurfaceG	ALL	glossv	CGSU66
		acid-etched	CGSU67
SurfaceC	ALL	security lock white	CCS668
		security lock black	CCS669
	BAS	European Oak natural waxed	CCS518
		European Oak - tinted black	CCS592
		European Oak - un - treated	CCS657
		iron part -white matt powder coating	CCS618
		iron part - black matt powder coating	CCS619
Bulbs	ALL	bulb LED - WW, 4W, E14, 85-260V	CEB641
		bulb DIM LED - CW, 4W, E14, 85-260V	CEB642
Cable colour	ALL	white	CECL521
		black	CECL519
		red	CECL530
		arev	CECL520
		yellow	CECL606
	EXT	textile cable black /1m/- 3x0.75	CECL704
		textile cable white /1m/- 3x0.75	CECL713
		textile cable red /1m/- 3x0.75	CECL715
		textile cable arev /1m/- 3x0.75	CECL716
		textile cable yellow /1m/- 3x0.75	CECL714
Certification	ALL	CE	CEC160
		EN 60598-1	CEC569
		EN 60598-2-1	CEC568

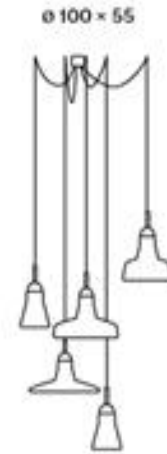

	X	Y	W	Z
PC891	280	2000	170	100

Identification

Name	SHADOWS SET FREE
Type	suspension lamp
Collection	SHADOWS
Line	Exclusive Line
Designed by	Lucie Koldová, Dan Yeffet

BROKIS

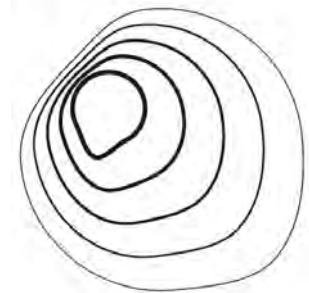

Description

Features	<p>Each light is hung on hook and power seduced into a wooden canopy. Paying homage to its typological heritage, the Shadows collection is a new take on the recognized and timeless French atelier pendant spot light. The five-lamp clusters feature different types of glass shade that slide over a wooden neck. The variable fittings allow you to apply your own creativity in composing new lighting experiences every day, while the purity of form is underscored by the hidden light source – a warm LED spotlight.</p>
-----------------	--

Technology	<p>The craftsmanship applied in production follows in the centuries-old tradition and experience of master glassmakers. The precision crafting of hand-blown glass instills distinctive, enduring character and outstanding quality in all Brokis products. The glass shades are formed from multiple layers of molten glass, each of which is scrutinized by the master glassmaker prior to being blown into the mold. Up to 70% of the resulting quality is achieved in this stage of production. No less attention to detail is paid in handcrafting the wooden elements of the light. Each piece is individually processed by the artisan in a series of strictly observed production stages. We take special care in selecting quality fine wood and ecologically friendly materials to treat it with.</p>
-------------------	---

Product Classification

Name	SHADOWS	SET FREE		
Bulbs	ALL	bulb LED - WW, 4W, E12 DIM, 85-260V	CEB701	
	BAS	triolex opal	CGC39	
	STA	black - transparent	CGC602	
		black - triplex opal	CGC36	
		smoke brown	CGC538	
		opaline	CGC38	
		smoke grey	CGC516	
		transparent	CGC23	
	SurfaceG	ALL	glossv	CGSU66
			acid-etched	CGSU67
SurfaceC	BAS	European Oak natural waxed	CCS518	
		European Oak - tinted black	CCS592	
		European Oak - un - treated	CCS657	
Bulbs	ALL	bulb LED - WW, 4W, E14, 85-260V	CEB641	
		bulb DIM LED - CW, 4W, E14, 85-260V	CEB642	
Cable colour	ALL	white	CECL521	
		black	CECL519	
		red	CECL530	
		grey	CECL520	
		yellow	CECL606	
	EXT	textile cable white /1m/- 3x0.75	CECL713	
		textile cable black /1m/- 3x0.75	CECL704	
		textile cable red /1m/- 3x0.75	CECL715	
		textile cable grey /1m/- 3x0.75	CECL716	
		textile cable yellow /1m/- 3x0.75	CECL714	
Certification	ALL	CE	CEC160	
		EN 60598-1	CEC567	
		EN 60598-2-1	CEC568	

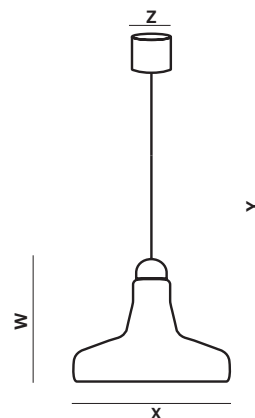

	X	Y	W	Z
PC894	250	2273	159	60

Identification

Name	SHADOWS
Type	suspension lamp
Collection	SHADOWS
Line	Exclusive Line
Designed by	Lucie Koldová, Dan Yeffet

BROKIS

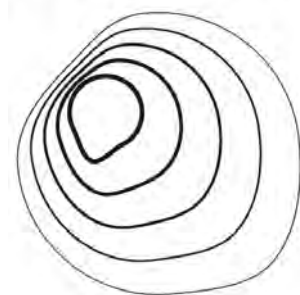

Description

Features

Paying homage to its typological heritage, the Shadows collection is a new take on the recognized and timeless French atelier pendant spot light. The five-lamp clusters feature different types of glass shade that slide over a wooden neck. The variable fittings allow you to apply your own creativity in composing new lighting experiences every day, while the purity of form is underscored by the hidden light source – a warm LED spotlight.

Technology

The craftsmanship applied in production follows in the centuries-old tradition and experience of master glassmakers. The precision crafting of hand-blown glass instills distinctive, enduring character and outstanding quality in all Brokis products. The glass shades are formed from multiple layers of molten glass, each of which is scrutinized by the master glassmaker prior to being blown into the mold. Up to 70% of the resulting quality is achieved in this stage of production. No less attention to detail is paid in handcrafting the wooden elements of the light. Each piece is individually processed by the artisan in a series of strictly observed production stages. We take special care in selecting quality fine wood and ecologically friendly materials to treat it with.

Product Classification

Name SHADOWS

Colour

BAS

triplex opal

CGC39

STA

black - transparent

CGC602

black - triplex opal

CGC36

smoke brown

CGC538

opaline

CGC38

smoke orev

CGC516

transparent

CGC23

SurfaceG

ALL

glossv

CGSU66

acid-etched

CGSU67

SurfaceC

BAS

European Oak natural waxed

CCS518

European Oak - tinted black

CCS592

European Oak - un - treated

CCS657

Bulbs

ALL

bulb LED - WW. 4W. E14. 85-260V

CEB641

bulb DIM LED - CW. 4W. E14. 85-260V

CEB642

Cable colour

ALL

white

CECL521

black

CECL519

red

CECL530

orev

CECL520

yellow

CECL606

Certification

ALL

CE

CEC160

EN 60598-1

CEC567

EN 60598-2-1

CEC568

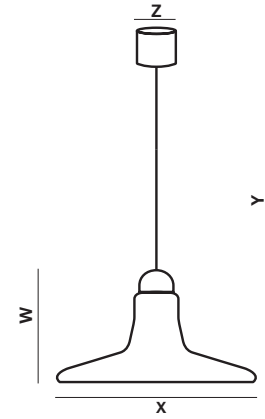

	X	Y	W	Z
PC895	280	2237	123	60

Identification

Name	SHADOWS
Type	suspension lamp
Collection	SHADOWS
Line	Exclusive Line
Designed by	Lucie Koldová, Dan Yeffet

BROKIS

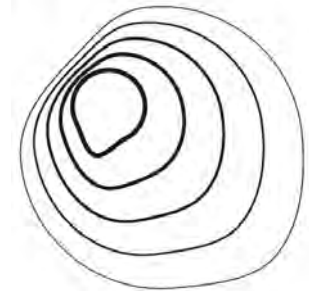

Description

Features

Paying homage to its typological heritage, the Shadows collection is a new take on the recognized and timeless French atelier pendant spot light. The five-lamp clusters feature different types of glass shade that slide over a wooden neck. The variable fittings allow you to apply your own creativity in composing new lighting experiences every day, while the purity of form is underscored by the hidden light source – a warm LED spotlight.

Technology

The craftsmanship applied in production follows in the centuries-old tradition and experience of master glassmakers. The precision crafting of hand-blown glass instills distinctive, enduring character and outstanding quality in all Brokis products. The glass shades are formed from multiple layers of molten glass, each of which is scrutinized by the master glassmaker prior to being blown into the mold. Up to 70% of the resulting quality is achieved in this stage of production. No less attention to detail is paid in handcrafting the wooden elements of the light. Each piece is individually processed by the artisan in a series of strictly observed production stages. We take special care in selecting quality fine wood and ecologically friendly materials to treat it with.

Product Classification

Name SHADOWS

Colour

BAS

triplex opal

CGC39

STA

black - transparent

CGC602

black - triplex opal

CGC36

smoke brown

CGC538

opaline

CGC38

smoke arev

CGC516

transparent

CGC23

SurfaceG

ALL

glossv

CGSU66

acid-etched

CGSU67

SurfaceC

ALL

European Oak natural waxed

CCS518

European Oak - tinted black

CCS592

BAS

European Oak - un - treated

CCS657

Bulbs

ALL

bulb LED - WW, 4W, E14, 85-260V

CEB641

bulb DIM LED - CW, 4W, E14, 85-260V

CEB642

Cable colour

ALL

white

CECL521

black

CECL519

red

CECL530

arev

CECL520

yellow

CECL606

Certification

ALL

CE

CEC160

EN 60598-1

CEC567

EN 60598-2-1

CEC568

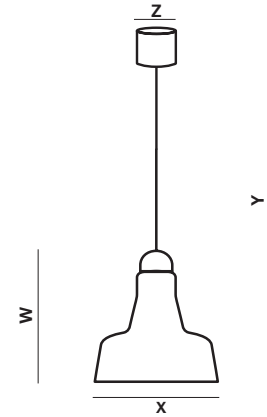

	X	Y	W	Z
PC896	189	2284	170	60

Identification

Name	SHADOWS
Type	suspension lamp
Collection	SHADOWS
Line	Exclusive Line
Designed by	Lucie Koldová, Dan Yeffet

BROKIS

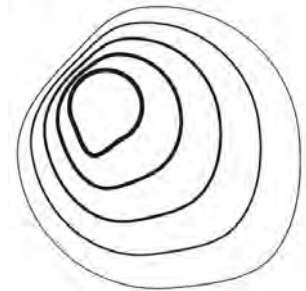

Description

Features

Paying homage to its typological heritage, the Shadows collection is a new take on the recognized and timeless French atelier pendant spot light. The five-lamp clusters feature different types of glass shade that slide over a wooden neck. The variable fittings allow you to apply your own creativity in composing new lighting experiences every day, while the purity of form is underscored by the hidden light source – a warm LED spotlight.

Technology

The craftsmanship applied in production follows in the centuries-old tradition and experience of master glassmakers. The precision crafting of hand-blown glass instills distinctive, enduring character and outstanding quality in all Brokis products. The glass shades are formed from multiple layers of molten glass, each of which is scrutinized by the master glassmaker prior to being blown into the mold. Up to 70% of the resulting quality is achieved in this stage of production. No less attention to detail is paid in handcrafting the wooden elements of the light. Each piece is individually processed by the artisan in a series of strictly observed production stages. We take special care in selecting quality fine wood and ecologically friendly materials to treat it with.

Product Classification

Name SHADOWS

Colour

BAS

triplex opal

CGC39

STA

black - transparent

CGC602

black - triplex opal

CGC36

smoke brown

CGC538

opaline

CGC38

smoke orev

CGC516

transparent

CGC23

SurfaceG

ALL

glossv

CGSU66

acid-etched

CGSU67

SurfaceC

BAS

European Oak natural waxed

CCS518

European Oak - tinted black

CCS592

European Oak - un - treated

CCS657

Bulbs

ALL

bulb LED - WW. 4W. E14. 85-260V

CEB641

bulb DIM LED - CW. 4W. E14. 85-260V

CEB642

Cable colour

ALL

white

CECL521

black

CECL519

red

CECL530

orev

CECL520

yellow

CECL606

Certification

ALL

CE

CEC160

EN 60598-1

CEC567

EN 60598-2-1

CEC568

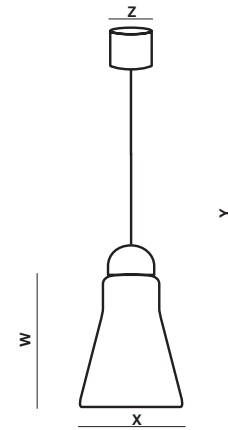

	X	Y	W	Z
PC897	108	2252	138	60

Identification

Name	SHADOWS
Type	suspension lamp
Collection	SHADOWS
Line	Exclusive Line
Designed by	Lucie Koldová, Dan Yeffet

BROKIS

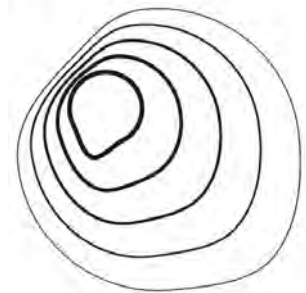

Description

Features

Paying homage to its typological heritage, the Shadows collection is a new take on the recognized and timeless French atelier pendant spot light. The five-lamp clusters feature different types of glass shade that slide over a wooden neck. The variable fittings allow you to apply your own creativity in composing new lighting experiences every day, while the purity of form is underscored by the hidden light source – a warm LED spotlight.

Technology

The craftsmanship applied in production follows in the centuries-old tradition and experience of master glassmakers. The precision crafting of hand-blown glass instills distinctive, enduring character and outstanding quality in all Brokis products. The glass shades are formed from multiple layers of molten glass, each of which is scrutinized by the master glassmaker prior to being blown into the mold. Up to 70% of the resulting quality is achieved in this stage of production. No less attention to detail is paid in handcrafting the wooden elements of the light. Each piece is individually processed by the artisan in a series of strictly observed production stages. We take special care in selecting quality fine wood and ecologically friendly materials to treat it with.

Product Classification

Name SHADOWS

Colour

BAS

triplex opal

CGC39

STA

black - transparent

CGC602

black - triplex opal

CGC36

smoke brown

CGC538

opaline

CGC38

smoke orev

CGC516

transparent

CGC23

SurfaceG

ALL

glossv

CGSU66

acid-etched

CGSU67

SurfaceC

BAS

European Oak natural waxed

CCS518

European Oak - tinted black

CCS592

European Oak - un - treated

CCS657

Bulbs

ALL

bulb LED - WW. 4W. E14. 85-260V

CEB641

bulb DIM LED - CW. 4W. E14. 85-260V

CEB642

Cable colour

ALL

white

CECL521

black

CECL519

red

CECL530

orev

CECL520

yellow

CECL606

Certification

ALL

CE

CEC160

EN 60598-1

CEC567

EN 60598-2-1

CEC568

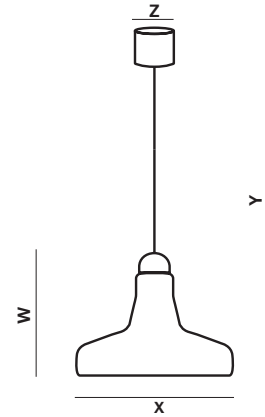

	X	Y	W	Z
PC911	395	2325	225	60

Identification

Name	SHADOWS XL
Type	suspension lamp
Collection	SHADOWS
Line	Exclusive Line
Designed by	Lucie Koldová, Dan Yeffet

BROKIS

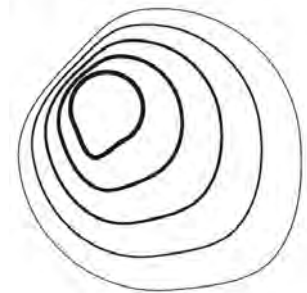

Description

Features	<p>Shadows XL is loosely based on the collection of lights Shadows. Paying homage to its typological heritage, the Shadows collection is a new take on the recognized and timeless French atelier pendant spot light. The five-lamp clusters feature different types of glass shade that slide over a wooden neck. The variable fittings allow you to apply your own creativity in composing new lighting experiences every day, while the purity of form is underscored by the hidden light source – a warm LED spotlight.</p>
-----------------	---

Technology	<p>The craftsmanship applied in production follows in the centuries-old tradition and experience of master glassmakers. The precision crafting of hand-blown glass instills distinctive, enduring character and outstanding quality in all Brokis products. The glass shades are formed from multiple layers of molten glass, each of which is scrutinized by the master glassmaker prior to being blown into the mold. Up to 70% of the resulting quality is achieved in this stage of production. No less attention to detail is paid in handcrafting the wooden elements of the light. Each piece is individually processed by the artisan in a series of strictly observed production stages. We take special care in selecting quality fine wood and ecologically friendly materials to treat it with.</p>
-------------------	---

Product Classification

Name	SHADOWS	XL	
Colour	BAS	black - transparent black - triplex opal smoke brown opaline smoke grey transparent triplex opal	CGC602 CGC36 CGC538 CGC38 CGC516 CGC23 CGC39
SurfaceG	ALL	gloss acid-etched	CGSU66 CGSU67
SurfaceC	BAS	European Oak natural waxed European Oak - tinted black European Oak - un - treated	CCS518 CCS592 CCS657
Bulbs	ALL	bulbDIM LED - WW. 5.5W. E27. 85-260V bulb DIM LED - CW. 5.5W. E27. 85-260V	CEB621 CEB607
Cable colour	ALL	white black red grey yellow	CECL521 CECL519 CECL530 CECL520 CECL606
	EXT	textile cable white /1m/- 3x0.75 textile cable black /1m/- 3x0.75 textile cable red /1m/- 3x0.75 textile cable grey /1m/- 3x0.75 textile cable yellow /1m/- 3x0.75	CECL713 CECL704 CECL715 CECL716 CECL714
Certification	ALL	CE EN 60598-1 EN 60598-2-1	CEC160 CEC567 CEC568

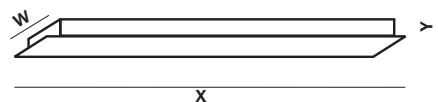

	x	y	w	z
PC920		53	360	1000

Identification

Name SHADOWS
RECTANGULAR LARGE

BROKIS

Type accessories
Collection SHADOWS
Line Exclusive Line
Designed by Lucie Koldová, Dan Yeffet

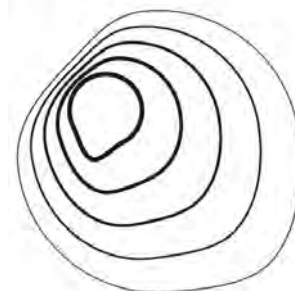

Description

Features Rectangular metal canopy used for hanging one set of Shadows (1 set = 5 lamps Shadows). We offer two colors.

Technology

Product Classification

Name

SHADOWS

RECTANGULAR LARGE

SurfaceC

ALL

iron part -white matt powder coating
iron part - black matt powder coating

CCS618
CCS619

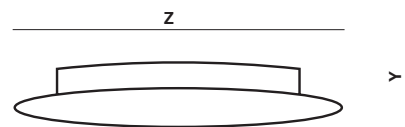

x	y	w	z
PC917	53		400

Identification

Name	SHADOWS RING METAL CANOPY
Type	accessories
Collection	SHADOWS
Line	Exclusive Line
Designed by	Lucie Koldová, Dan Yeffet

BROKIS

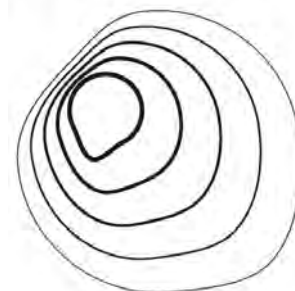

Description

Features	The metal canopy comes in either rectangular or circular form and is designed for use with an entire set of five lights, while an optional version of the rectangular canopy is available with ten openings to accommodate dual sets of lights. We can adjust the number of openings in the wooden and metal canopies to satisfy special orders. When ordering the metal canopy, choose from either white or black in a polished or matte finish. The canopies have been designed to comply with installation guidelines around the world, including the USA.
-----------------	---

Technology

Product Classification

Name

SHADOWS

RING METAL CANOPY

SurfaceC

ALL

iron part -white matt powder coating
iron part - black matt powder coating

CCS618
CCS619

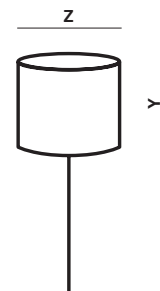

	x	y	w	z
PC916		55		100

Identification

Name	SHADOWS SET WOOD CANOPY
Type	accessories
Collection	SHADOWS
Line	Exclusive Line
Designed by	Lucie Koldová, Dan Yeffet

BROKIS

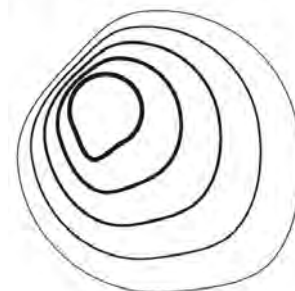

Description

Features	The wooden canopy for hanging lamps design in Shadows Set free.
----------	---

Technology

Product Classification

Name **SHADOWS** **SET WOOD CANOPY**

SurfaceC

ALL

European Oak natural waxed
European Oak - tinted black
European Oak - un - treated

CCS518
CCS592
CCS657

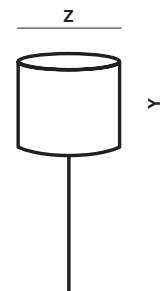

	x	y	w	z
PC915		50		60

Identification

Name	SHADOWS SINGLE WOOD CANOPY
Type	accessories
Collection	SHADOWS
Line	Exclusive Line
Designed by	Lucie Koldová, Dan Yeffet

BROKIS

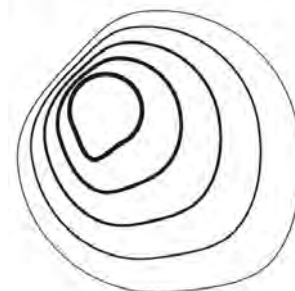

Description

Features	The wooden and metal canopies of the Shadows collection allow for a high degree of versatility and creativity when installing the light units. We offer the handmade wooden canopy in two standard versions – either with one opening for a single light unit, or with five openings for an entire set of lights.
-----------------	---

Technology

Product Classification

Name **SHADOWS** **SINGLE WOOD CANOPY**

SurfaceC

ALL

European Oak natural waxed
European Oak - tinted black
European Oak - un - treated

CCS518
CCS592
CCS657

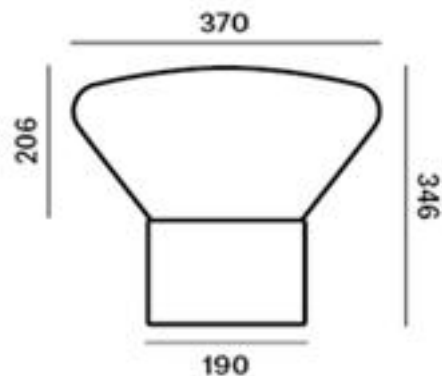

	x	y	w	z
PC849	370	346	206	190

Identification

Name	Muffins WOOD 01
Type	table lamp
Collection	Muffins
Line	Exclusive Line
Designed by	Lucie Koldová a Dan Yeffet

BROKIS

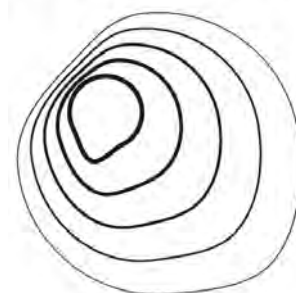

Description

Features	Muffin lamps convey a truly extraordinary lighting experience. Their puffy, round shapes and combination of traditional hand-blown tinted glass, oak, and gentle light fill any space with a special aura. The singular design and exceptional quality of the Muffin lamps caught the attention of Yves Saint Lorraine, which used them in a TV advertisement for its 2011 men's collection. The Muffin collection comprises three basic variants – floor, ceiling, and table – that can be fitted with a wooden lamp body as well as different glass shades in subtle tones of grey, brown, and yellow.
-----------------	--

Technology	The craftsmanship applied in production follows in the centuries-old tradition and experience of master glassmakers. The precision crafting of hand-blown glass instills distinctive, enduring character and outstanding quality in all Brokis products. The glass shades are formed from multiple layers of molten glass, each of which is scrutinized by the master glassmaker prior to being blown into the mold. Up to 70% of the resulting quality is achieved in this stage of production. No less attention to detail is paid in handcrafting the wooden elements of the light. Each piece is individually processed by the artisan in a series of strictly observed production stages. We take special care in selecting quality fine wood and ecologically friendly materials to treat it with.
-------------------	--

Product Classification

Name	Muffins	WOOD 01			
Colour	BAS	amber	CGC515		
		coqnac	CGC540		
		violet - transparent	CGC554		
		smoke brown	CGC538		
		opaline	CGC38		
		smoke grey	CGC516		
		transparent	CGC23		
		triplex opal	CGC39		
		SurfaceG	ALL	glossv	CGSU66
SurfaceC	BAS	European Oak natural waxed	CCS518		
		European Oak - un - treated	CCS657		
	STA	European Oak - tinted black	CCS592		
	ADD	European Oak tinted white	CCS680		
Bulbs	ALL	bulb 60W, E26, 120V	CEB643		
		bulb 60W, E27, 240V	CEB522		
Cable colour	ALL	white	CECL521		
		black	CECL519		
		red	CECL530		
		grey	CECL520		
		yellow	CECL606		
Switch	ALL	bipolar switch	CES493		
	EXT	black dimmer - table	CES474		
		transparent dimmer - table	CES99		
Certification	ALL	CE	GEC160		
		EN 60598-1	GEC569		
		EN 60598-2-4	GEC570		

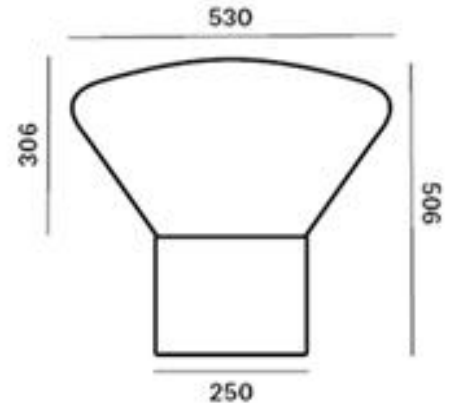

	X	Y	W	Z
PC850	530	506	306	250

Identification

Name	Muffins WOOD 02
Type	table lamp
Collection	Muffins
Line	Exclusive Line
Designed by	Lucie Koldová a Dan Yeffet

BROKIS

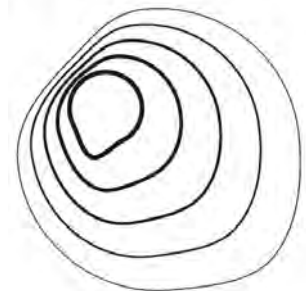

Description

Features

Muffin lamps convey a truly extraordinary lighting experience. Their puffy, round shapes and combination of traditional hand-blown tinted glass, oak, and gentle light fill any space with a special aura. The singular design and exceptional quality of the Muffin lamps caught the attention of Yves Saint Lorraine, which used them in a TV advertisement for its 2011 men's collection. The Muffin collection comprises three basic variants – floor, ceiling, and table – that can be fitted with a wooden lamp body as well as different glass shades in subtle tones of grey, brown, and yellow.

Technology

The craftsmanship applied in production follows in the centuries-old tradition and experience of master glassmakers. The precision crafting of hand-blown glass instills distinctive, enduring character and outstanding quality in all Brokis products. The glass shades are formed from multiple layers of molten glass, each of which is scrutinized by the master glassmaker prior to being blown into the mold. Up to 70% of the resulting quality is achieved in this stage of production. No less attention to detail is paid in handcrafting the wooden elements of the light. Each piece is individually processed by the artisan in a series of strictly observed production stages. We take special care in selecting quality fine wood and ecologically friendly materials to treat it with.

Product Classification

Name	Muffins	WOOD 02	
Colour	BAS	amber coqnac violet - transparent smoke brown opaline smoke grey transparent triplex opal	CGC515 CGC540 CGC554 CGC538 CGC38 CGC516 CGC23 CGC39
SurfaceG	ALL	glossv	CGSU66
SurfaceC	BAS	European Oak natural waxed European Oak - un - treated	CCS518 CCS657
	STA	European Oak - tinted black	CCS592
	ADD	European Oak tinted white	CCS680
Bulbs	ALL	bulb 60W, E26, 120V bulb 60W, E27, 240V	CEB643 CEB522
Cable colour	ALL	white black red grey yellow	CECL521 CECL519 CECL530 CECL520 CECL606
Switch	ALL	bipolar switch	CES493
	EXT	black dimmer - table transparent dimmer - table	CES474 CES99
Certification	ALL	CE EN 60598-1 EN 60598-2-4	GEC160 GEC569 GEC570

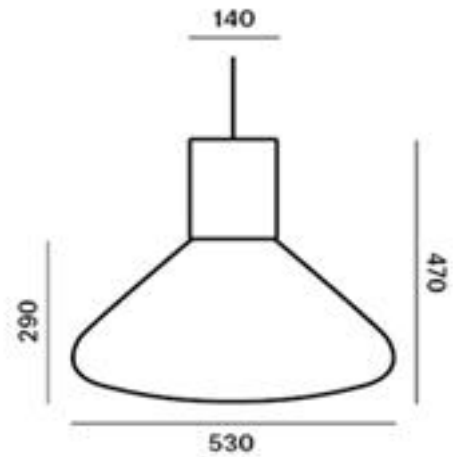

	X	Y	W	Z
PC851	530	470	290	140

Identification

Name	Muffins WOOD 03B
Type	suspension lamp
Collection	Muffins
Line	Exclusive Line
Designed by	Lucie Koldová a Dan Yeffet

BROKIS

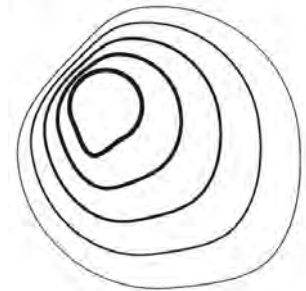

Description

Features Muffin lamps convey a truly extraordinary lighting experience. Their puffy, round shapes and combination of traditional hand-blown tinted glass, oak, and gentle light fill any space with a special aura. The singular design and exceptional quality of the Muffin lamps caught the attention of Yves Saint Lorraine, which used them in a TV advertisement for its 2011 men's collection. The Muffin collection comprises three basic variants – floor, ceiling, and table – that can be fitted with a wooden lamp body as well as different glass shades in subtle tones of grey, brown, and yellow.

Technology The craftsmanship applied in production follows in the centuries-old tradition and experience of master glassmakers. The precision crafting of hand-blown glass instills distinctive, enduring character and outstanding quality in all Brokis products. The glass shades are formed from multiple layers of molten glass, each of which is scrutinized by the master glassmaker prior to being blown into the mold. Up to 70% of the resulting quality is achieved in this stage of production. No less attention to detail is paid in handcrafting the wooden elements of the light. Each piece is individually processed by the artisan in a series of strictly observed production stages. We take special care in selecting quality fine wood and ecologically friendly materials to treat it with.

Product Classification

Name	Muffins	WOOD 03B			
Colour	BAS	amber	CGC515		
		coqnac	CGC540		
		violet - transparent	CGC554		
		smoke brown	CGC538		
		opaline	CGC38		
		smoke grey	CGC516		
		transparent	CGC23		
		triplex opal	CGC39		
		SurfaceG	ALL	glossv	CGSU66
SurfaceC	BAS	European Oak natural waxed	CCS518		
		European Oak - un - treated	CCS657		
	STA	European Oak - tinted black	CCS592		
	ADD	European Oak tinted white	CCS680		
Bulbs	ALL	bulb 60W, E26, 120V	CEB643		
		bulb 60W, E27, 240V	CEB522		
Cable colour	ALL	white	CECL521		
		black	CECL519		
		red	CECL530		
		grey	CECL520		
		yellow	CECL606		
	EXT	textile cable white /1m/- 3x0.75	CECL713		
		textile cable black /1m/- 3x0.75	CECL704		
		textile cable red /1m/- 3x0.75	CECL715		
		textile cable grey /1m/- 3x0.75	CECL716		
		textile cable yellow /1m/- 3x0.75	CECL714		
Certification	ALL	CE	CEC160		
		EN 60598-1	CEC567		
		EN 60598-2-1	CEC568		

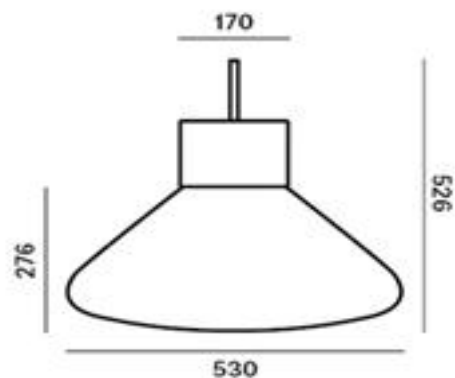

	X	Y	W	Z
PC852	530	526	276	170

Identification

Name	Muffins WOOD 03A
Type	portable
Collection	Muffins
Line	Exclusive Line
Designed by	Lucie Koldová a Dan Yeffet

BROKIS

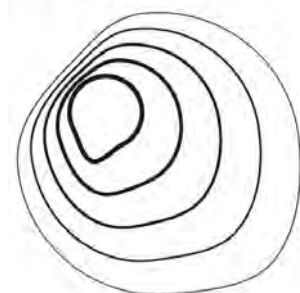

Description

Features	Muffin lamps convey a truly extraordinary lighting experience. Their puffy, round shapes and combination of traditional hand-blown tinted glass, oak, and gentle light fill any space with a special aura. The singular design and exceptional quality of the Muffin lamps caught the attention of Yves Saint Lorraine, which used them in a TV advertisement for its 2011 men's collection. The Muffin collection comprises three basic variants – floor, ceiling, and table – that can be fitted with a wooden lamp body as well as different glass shades in subtle tones of grey, brown, and yellow.
-----------------	--

Technology	The craftsmanship applied in production follows in the centuries-old tradition and experience of master glassmakers. The precision crafting of hand-blown glass instills distinctive, enduring character and outstanding quality in all Brokis products. The glass shades are formed from multiple layers of molten glass, each of which is scrutinized by the master glassmaker prior to being blown into the mold. Up to 70% of the resulting quality is achieved in this stage of production. No less attention to detail is paid in handcrafting the wooden elements of the light. Each piece is individually processed by the artisan in a series of strictly observed production stages. We take special care in selecting quality fine wood and ecologically friendly materials to treat it with.
-------------------	--

Product Classification

Name	Muffins	WOOD 03A	
Colour	BAS	amber coqnac violet - transparent smoke brown opaline smoke grey transparent triplex opal	CGC515 CGC540 CGC554 CGC538 CGC38 CGC516 CGC23 CGC39
SurfaceG	ALL	glossv	CGSU66
SurfaceC	BAS	European Oak natural waxed European Oak - un - treated	CCS518 CCS657
	STA	European Oak - tinted black	CCS592
	ADD	European Oak tinted white	CCS680
Bulbs	ALL	bulb 60W, E26, 120V bulb 60W, E27, 240V	CEB643 CEB522
Cable colour	ALL	white black red grey yellow	CECL521 CECL519 CECL530 CECL520 CECL606
Switch	ALL	bipolar switch	CES493
	EXT	black dimmer - floor transparent dimmer - floor	CES492 CES481
Certification	ALL	CE EN 60598-1 EN 60598-2-4	GEC160 GEC569 GEC570

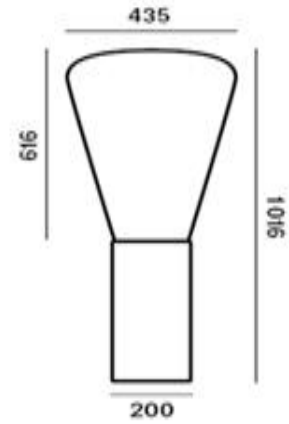

	X	Y	W	Z
PC853	435	1016	616	200

Identification

Name	Muffins WOOD 04
Type	floor lamp
Collection	Muffins
Line	Exclusive Line
Designed by	Lucie Koldová a Dan Yeffet

BROKIS

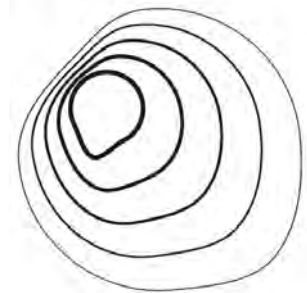

Description

Features	Muffin lamps convey a truly extraordinary lighting experience. Their puffy, round shapes and combination of traditional hand-blown tinted glass, oak, and gentle light fill any space with a special aura. The singular design and exceptional quality of the Muffin lamps caught the attention of Yves Saint Lorraine, which used them in a TV advertisement for its 2011 men's collection. The Muffin collection comprises three basic variants – floor, ceiling, and table – that can be fitted with a wooden lamp body as well as different glass shades in subtle tones of grey, brown, and yellow.
-----------------	--

Technology	The craftsmanship applied in production follows in the centuries-old tradition and experience of master glassmakers. The precision crafting of hand-blown glass instills distinctive, enduring character and outstanding quality in all Brokis products. The glass shades are formed from multiple layers of molten glass, each of which is scrutinized by the master glassmaker prior to being blown into the mold. Up to 70% of the resulting quality is achieved in this stage of production. No less attention to detail is paid in handcrafting the wooden elements of the light. Each piece is individually processed by the artisan in a series of strictly observed production stages. We take special care in selecting quality fine wood and ecologically friendly materials to treat it with.
-------------------	--

Product Classification

Name	Muffins	WOOD 04	
Colour	BAS	amber coqnac violet - transparent smoke brown opaline smoke arev transparent triplex opal	CGC515 CGC540 CGC554 CGC538 CGC38 CGC516 CGC23 CGC39
SurfaceG	ALL	alossv	CGSU66
SurfaceC	BAS	European Oak natural waxed European Oak - un - treated	CCS518 CCS657
	STA	European Oak - tinted black	CCS592
	ADD	European Oak tinted white	CCS680
Bulbs	ALL	bulb 60W, E26, 120V bulb 60W, E27, 240V	CEB643 CEB522
Cable colour	ALL	white black red arev yellow	CECL521 CECL519 CECL530 CECL520 CECL606
Switch	ALL	bipolar switch	floor CES508
	EXT	black dimmer - floor transparent dimmer - floor	CES492 CES481
Certification	ALL	CE EN 60598-1 EN 60598-2-4	GEC160 GEC569 GEC570

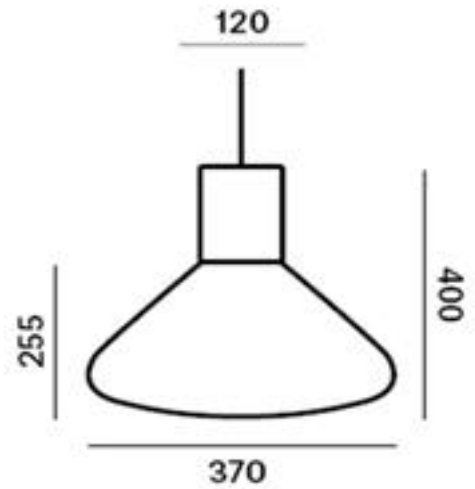

	x	y	w	z
PC865	370	400	255	120

Identification

Name	Muffins WOOD 05P
Type	suspension lamp
Collection	Muffins
Line	Exclusive Line
Designed by	Lucie Koldová a Dan Yeffet

BROKIS

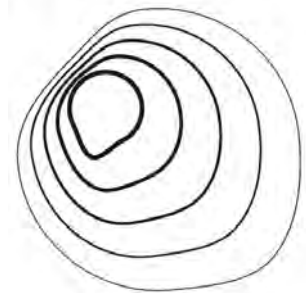

Description

Features

Muffin lamps convey a truly extraordinary lighting experience. Their puffy, round shapes and combination of traditional hand-blown tinted glass, oak, and gentle light fill any space with a special aura. The singular design and exceptional quality of the Muffin lamps caught the attention of Yves Saint Lorraine, which used them in a TV advertisement for its 2011 men's collection. The Muffin collection comprises three basic variants – floor, ceiling, and table – that can be fitted with a wooden lamp body as well as different glass shades in subtle tones of grey, brown, and yellow.

Technology

The craftsmanship applied in production follows in the centuries-old tradition and experience of master glassmakers. The precision crafting of hand-blown glass instills distinctive, enduring character and outstanding quality in all Brokis products. The glass shades are formed from multiple layers of molten glass, each of which is scrutinized by the master glassmaker prior to being blown into the mold. Up to 70% of the resulting quality is achieved in this stage of production. No less attention to detail is paid in handcrafting the wooden elements of the light. Each piece is individually processed by the artisan in a series of strictly observed production stages. We take special care in selecting quality fine wood and ecologically friendly materials to treat it with.

Product Classification

Name	Muffins	WOOD 05P
Colour	BAS	amber coqnac violet - transparent smoke brown opaline smoke grey transparent triplex opal
		CGC515 CGC540 CGC554 CGC538 CGC38 CGC516 CGC23 CGC39
SurfaceG	ALL	glossv
		CGSU66
SurfaceC	BAS	European Oak natural waxed European Oak - un - treated
	STA	European Oak - tinted black
	ADD	European Oak tinted white
		CCS518 CCS657 CCS592 CCS680
Bulbs	ALL	bulb 60W, E26, 120V bulb 60W, E27, 240V
		CEB643 CEB522
Cable colour	ALL	white black red grey yellow
	EXT	textile cable white /1m/- 3x0.75 textile cable black /1m/- 3x0.75 textile cable red /1m/- 3x0.75 textile cable grey /1m/- 3x0.75 textile cable yellow /1m/- 3x0.75
		CECL521 CECL519 CECL530 CECL520 CECL606 CECL713 CECL704 CECL715 CECL716 CECL714
Certification	ALL	CE EN 60598-1 EN 60598-2-1
		CEC160 CEC567 CEC568

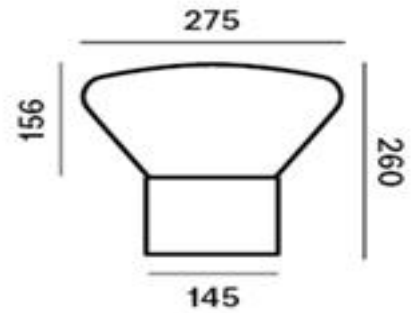

	x	y	w	z
PC910	275	260	156	145

Identification

Name	Muffins MINI WOOD 06
Type	table lamp
Collection	Muffins
Line	Exclusive Line
Designed by	Lucie Koldová a Dan Yeffet

BROKIS

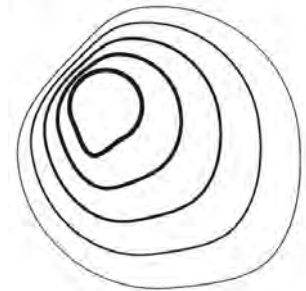

Description

Features	Muffin lamps convey a truly extraordinary lighting experience. Their puffy, round shapes and combination of traditional hand-blown tinted glass, oak, and gentle light fill any space with a special aura. The singular design and exceptional quality of the Muffin lamps caught the attention of Yves Saint Lorraine, which used them in a TV advertisement for its 2011 men's collection. The Muffin collection comprises three basic variants – floor, ceiling, and table – that can be fitted with a wooden lamp body as well as different glass shades in subtle tones of grey, brown, and yellow.
Technology	The craftsmanship applied in production follows in the centuries-old tradition and experience of master glassmakers. The precision crafting of hand-blown glass instills distinctive, enduring character and outstanding quality in all Brokis products. The glass shades are formed from multiple layers of molten glass, each of which is scrutinized by the master glassmaker prior to being blown into the mold. Up to 70% of the resulting quality is achieved in this stage of production. No less attention to detail is paid in handcrafting the wooden elements of the light. Each piece is individually processed by the artisan in a series of strictly observed production stages. We take special care in selecting quality fine wood and ecologically friendly materials to treat it with.

Product Classification

Name	Muffins	MINI WOOD 06	
Colour	BAS	amber coqnac violet - transparent smoke brown opaline smoke arev transparent triplex opal	CGC515 CGC540 CGC554 CGC538 CGC38 CGC516 CGC23 CGC39
SurfaceG	ALL	alossv	CGSU66
SurfaceC	BAS	European Oak natural waxed European Oak - un - treated	CCS518 CCS657
	STA	European Oak - tinted black	CCS592
	ADD	European Oak tinted white	CCS680
Bulbs	ALL	bulb 15W, E12, 120V bulb 40W, E14, 240V	CEB644 CEB651
Cable colour	ALL	white black red arev yellow	CECL521 CECL519 CECL530 CECL520 CECL606
Switch	ALL	bipolar switch	CES493
	EXT	black dimmer - table transparent dimmer - table	CES474 CES99
Certification	ALL	CE EN 60598-1 EN 60598-2-4	GEC160 GEC569 GEC570



	X	Y	W	Z
PC856	285	400	255	239

Identification

Name	Balloons SMALL
Type	table lamp
Collection	Balloons
Line	Exclusive Line
Designed by	Lucie Koldová, Dan Yeffet

BROKIS

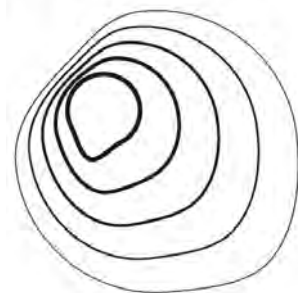

Description

Features	A collection of simple yet timeless lamps based on a transparent, nearly invisible balloon with a hovering reflector to serve as an elegant and stately source of light in any setting. The natural beauty of the quality hand-blown glass is underlined by the clean appearance of the transparent balloons. The collection features a small table model and two free-standing models. The size of the largest Balloon shade is the embodiment of exceptional glassblowing craftsmanship, as it pushes the technique to its very limits.
-----------------	---

Technology	The craftsmanship applied in production follows in the centuries-old tradition and experience of master glassmakers. The precision crafting of hand-blown glass instills distinctive, enduring character and outstanding quality in all Brokis products. The glass shades are formed from multiple layers of molten glass, each of which is scrutinized by the master glassmaker prior to being blown into the mold. Up to 70% of the resulting quality is achieved in this stage of production. The metal reflector is manufactured through a unique metal stamping technique that has been proven over the course of millennia and involves spinning cold sheet metal on a rotating form. The history of this technology goes back to Celtic times. As with the glassmakers, the master metalworkers draw upon the tradition and experience that have been carefully passed down through the ages and give the final product exceptional added value.
-------------------	---

Product Classification

Name	Balloons	SMALL
Colour	ALL	smoke brown CGC538 smoke grey CGC516 transparent CGC23
SurfaceG	ALL	glossy CGSU66
SurfaceC	BAS	white CCS575 lemon yellow CCS613 black CCS582 reflective orange CCS574 gold CCS583
	ADD	chrome CCS275 copper CCS584 brass CCS69
Bulbs	ALL	bulb 15W. E12. 120V CEB644 bulb 40W.E14. 240V CEB651
Cable colour	ALL	white CECL521 black CECL519 red CECL530 grey CECL520 yellow CECL606
Switch	ALL	bipolar switch CES493
	EXT	black dimmer - table CES474 transparent dimmer - table CES99
Certification	ALL	CE CEC160 EN 60598-1 CEC569 EN 60598-2-4 CEC570



	X	Y	W	Z
PC857	428	600	390	359

Identification

Name	Balloons MEDIUM
Type	table lamp
Collection	Balloons
Line	Exclusive Line
Designed by	Lucie Koldová, Dan Yeffet

BROKIS

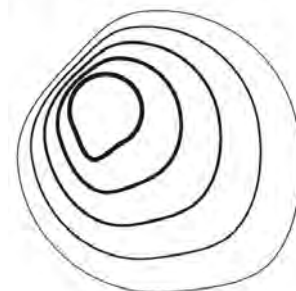

Description

Features	A collection of simple yet timeless lamps based on a transparent, nearly invisible balloon with a hovering reflector to serve as an elegant and stately source of light in any setting. The natural beauty of the quality hand-blown glass is underlined by the clean appearance of the transparent balloons. The collection features a small table model and two free-standing models. The size of the largest Balloon shade is the embodiment of exceptional glassblowing craftsmanship, as it pushes the technique to its very limits.
-----------------	---

Technology	The craftsmanship applied in production follows in the centuries-old tradition and experience of master glassmakers. The precision crafting of hand-blown glass instills distinctive, enduring character and outstanding quality in all Brokis products. The glass shades are formed from multiple layers of molten glass, each of which is scrutinized by the master glassmaker prior to being blown into the mold. Up to 70% of the resulting quality is achieved in this stage of production. The metal reflector is manufactured through a unique metal stamping technique that has been proven over the course of millennia and involves spinning cold sheet metal on a rotating form. The history of this technology goes back to Celtic times. As with the glassmakers, the master metalworkers draw upon the tradition and experience that have been carefully passed down through the ages and give the final product exceptional added value.
-------------------	---

Product Classification

Name	Balloons	MEDIUM
Colour	ALL	smoke brown CGC538 smoke grey CGC516 transparent CGC23
SurfaceG	ALL	glossv CGSU66
SurfaceC	BAS	white CCS575 lemon yellow CCS613 black CCS582 reflective orange CCS574 gold CCS583
	ADD	chrome CCS275 copper CCS584 brass CCS69
Bulbs	ALL	bulb 60W. E26. 120V CEB646 bulb 60W. E27. 240V CEB594
Cable colour	ALL	white CECL521 black CECL519 red CECL530 grey CECL520 yellow CECL606
Switch	ALL	bipolar switch CES493
	EXT	black dimmer - floor CES492 transparent dimmer - floor CES481
Certification	ALL	CE CEC160 EN 60598-1 CEC569 EN 60598-2-4 CEC570



	X	Y	W	Z
PC858	607	850	550	509

Identification

Name	Balloons LARGE
Type	floor lamp
Collection	Balloons
Line	Exclusive Line
Designed by	Lucie Koldová, Dan Yeffet

BROKIS

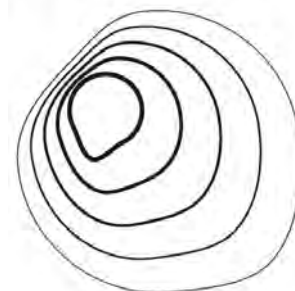

Description

Features	A collection of simple yet timeless lamps based on a transparent, nearly invisible balloon with a hovering reflector to serve as an elegant and stately source of light in any setting. The natural beauty of the quality hand-blown glass is underlined by the clean appearance of the transparent balloons. The collection features a small table model and two free-standing models. The size of the largest Balloon shade is the embodiment of exceptional glassblowing craftsmanship, as it pushes the technique to its very limits.
-----------------	---

Technology	The craftsmanship applied in production follows in the centuries-old tradition and experience of master glassmakers. The precision crafting of hand-blown glass instills distinctive, enduring character and outstanding quality in all Brokis products. The glass shades are formed from multiple layers of molten glass, each of which is scrutinized by the master glassmaker prior to being blown into the mold. Up to 70% of the resulting quality is achieved in this stage of production. The metal reflector is manufactured through a unique metal stamping technique that has been proven over the course of millennia and involves spinning cold sheet metal on a rotating form. The history of this technology goes back to Celtic times. As with the glassmakers, the master metalworkers draw upon the tradition and experience that have been carefully passed down through the ages and give the final product exceptional added value.
-------------------	---

Product Classification

Name	Balloons	LARGE	
Colour	ALL	smoke brown smoke grey transparent	CGC538 CGC516 CGC23
SurfaceG	ALL	glossv	CGSU66
SurfaceC	BAS	white lemon yellow black reflective orange gold	CCS575 CCS613 CCS582 CCS574 CCS583
	ADD	chrome copper brass	CCS275 CCS584 CCS69
Bulbs	ALL	bulb 60W. E27. 240V bulb 70W. E26. 120V	CEB595 CEB648
Cable colour	ALL	white black red grey yellow	CECL521 CECL519 CECL530 CECL520 CECL606
Switch	ALL	bipolar switch	floor CES508
	EXT	black dimmer - floor transparent dimmer - floor	CES492 CES481
Certification	ALL	CE EN 60598-1 EN 60598-2-4	CEC160 CEC569 CEC570

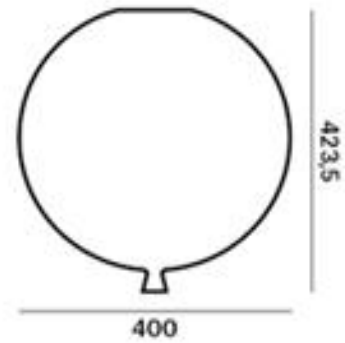

	X	Y	W	Z
PC876	400	423		146

Identification

Name	MEMORY CEILING
Type	ceiling
Collection	MEMORY
Line	Exclusive Line
Designed by	Boris Klimek

BROKIS

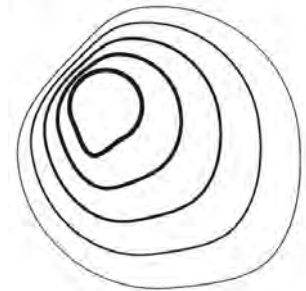

Description

Features	Playful, amusing, surprising – the Memory collection of ceiling and wall fixtures kindles the imagination and takes the beholder back to the carefree days of childhood. Three sizes and a range of colors allow you to turn your creativity loose in devising various lighting experiences. With the hanging strings serving to switch the lights on and off, there is nothing to interrupt the illusion of real balloons. This is beauty in its simplest and most effective form.
Technology	The craftsmanship applied in production follows in the centuries-old tradition and experience of master glassmakers. The precision crafting of hand-blown glass instills distinctive, enduring character and outstanding quality in all Brokis products. The glass shades are formed from multiple layers of molten glass, each of which is scrutinized by the master glassmaker prior to being blown into the mold. Up to 70% of the resulting quality is achieved in this stage of production. The triplex opal glass used in the production of the lampshade represents one of the highest quality materials used in the lighting industry. The sandwich combination of two transparent outer layers of crystal and an inner layer of white opal glass between them lend the glass outstanding optical properties, as do the carefully guarded handcraft techniques.

Product Classification

Name

MEMORY

CEILING

Colour

BAS

red - triplex opal
blue - triplex opal
orange - triplex opal
light pink - triplex opal
grey - triplex opal
triplex opal
turquoise - triplex opal
green apple - triplex opal
yellow - triplex opal

CGC579
CGC28
CGC580
CGC30
CGC617
CGC39
CGC601
CGC578
CGC47

SurfaceG

ALL

glossv
acid-etched

CGSU66
CGSU67

SurfaceC

BAS

iron chromate

CCS620

Certification

ALL

CE
EN 60598-1
EN 60598-2-1

CEC160
CEC567
CEC568

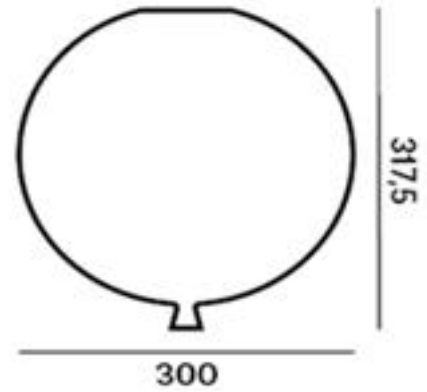

	X	Y	W	Z
PC877	300	317		146

Identification

Name	MEMORY CEILING
Type	ceiling
Collection	MEMORY
Line	Exclusive Line
Designed by	Boris Klimek

BROKIS

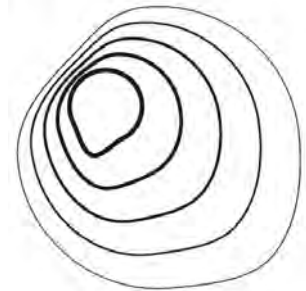

Description

Features	Playful, amusing, surprising – the Memory collection of ceiling and wall fixtures kindles the imagination and takes the beholder back to the carefree days of childhood. Three sizes and a range of colors allow you to turn your creativity loose in devising various lighting experiences. With the hanging strings serving to switch the lights on and off, there is nothing to interrupt the illusion of real balloons. This is beauty in its simplest and most effective form.
Technology	The craftsmanship applied in production follows in the centuries-old tradition and experience of master glassmakers. The precision crafting of hand-blown glass instills distinctive, enduring character and outstanding quality in all Brokis products. The glass shades are formed from multiple layers of molten glass, each of which is scrutinized by the master glassmaker prior to being blown into the mold. Up to 70% of the resulting quality is achieved in this stage of production. The triplex opal glass used in the production of the lampshade represents one of the highest quality materials used in the lighting industry. The sandwich combination of two transparent outer layers of crystal and an inner layer of white opal glass between them lend the glass outstanding optical properties, as do the carefully guarded handcraft techniques.

Product Classification

Name

MEMORY

CEILING

Colour

BAS

red - triplex opal
blue - triplex opal
orange - triplex opal
light pink - triplex opal
grey - triplex opal
triplex opal
turquoise - triplex opal
green apple - triplex opal
yellow - triplex opal

CGC579
CGC28
CGC580
CGC30
CGC617
CGC39
CGC601
CGC578
CGC47

SurfaceG

ALL

glossv
acid-etched

CGSU66
CGSU67

SurfaceC

BAS

iron chromate

CCS620

Certification

ALL

CE
EN 60598-1
EN 60598-2-1

CEC160
CEC567
CEC568

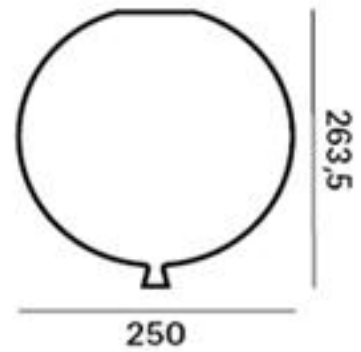

	X	Y	W	Z
PC878	250	263		146

Identification

Name	MEMORY CEILING
Type	ceiling
Collection	MEMORY
Line	Exclusive Line
Designed by	Boris Klimek

BROKIS

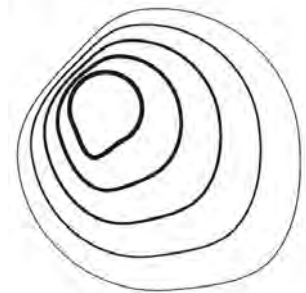

Description

Features	Playful, amusing, surprising – the Memory collection of ceiling and wall fixtures kindles the imagination and takes the beholder back to the carefree days of childhood. Three sizes and a range of colors allow you to turn your creativity loose in devising various lighting experiences. With the hanging strings serving to switch the lights on and off, there is nothing to interrupt the illusion of real balloons. This is beauty in its simplest and most effective form.
Technology	The craftsmanship applied in production follows in the centuries-old tradition and experience of master glassmakers. The precision crafting of hand-blown glass instills distinctive, enduring character and outstanding quality in all Brokis products. The glass shades are formed from multiple layers of molten glass, each of which is scrutinized by the master glassmaker prior to being blown into the mold. Up to 70% of the resulting quality is achieved in this stage of production. The triplex opal glass used in the production of the lampshade represents one of the highest quality materials used in the lighting industry. The sandwich combination of two transparent outer layers of crystal and an inner layer of white opal glass between them lend the glass outstanding optical properties, as do the carefully guarded handcraft techniques.

Product Classification

Name

MEMORY

CEILING

Colour

BAS

red - triplex opal
blue - triplex opal
orange - triplex opal
light pink - triplex opal
grey - triplex opal
triplex opal
turquoise - triplex opal
green apple - triplex opal
yellow - triplex opal

CGC579
CGC28
CGC580
CGC30
CGC617
CGC39
CGC601
CGC578
CGC47

SurfaceG

ALL

glossv
acid-etched

CGSU66
CGSU67

SurfaceC

BAS

iron chromate

CCS620

Certification

ALL

CE
EN 60598-1
EN 60598-2-1

CEC160
CEC567
CEC568

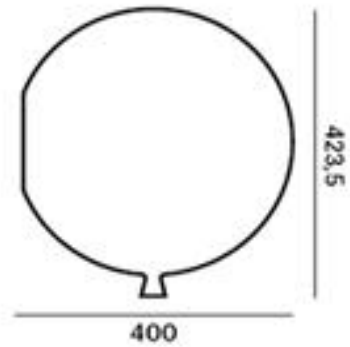
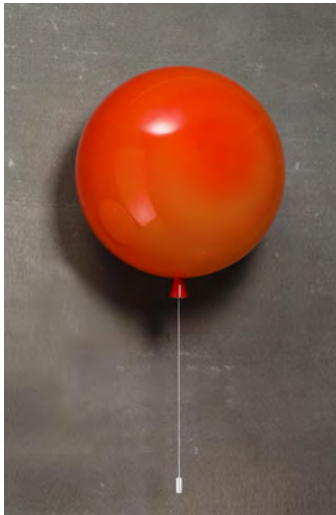

	X	Y	W	Z
PC879	400	423		146

Identification

Name	MEMORY WALL
Type	wall lamp
Collection	MEMORY
Line	Exclusive Line
Designed by	Boris Klimek

BROKIS

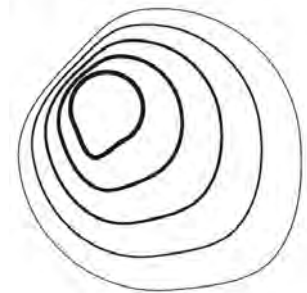

Description

Features	Playful, amusing, surprising – the Memory collection of ceiling and wall fixtures kindles the imagination and takes the beholder back to the carefree days of childhood. Three sizes and a range of colors allow you to turn your creativity loose in devising various lighting experiences. With the hanging strings serving to switch the lights on and off, there is nothing to interrupt the illusion of real balloons. This is beauty in its simplest and most effective form.
Technology	The craftsmanship applied in production follows in the centuries-old tradition and experience of master glassmakers. The precision crafting of hand-blown glass instills distinctive, enduring character and outstanding quality in all Brokis products. The glass shades are formed from multiple layers of molten glass, each of which is scrutinized by the master glassmaker prior to being blown into the mold. Up to 70% of the resulting quality is achieved in this stage of production. The triplex opal glass used in the production of the lampshade represents one of the highest quality materials used in the lighting industry. The sandwich combination of two transparent outer layers of crystal and an inner layer of white opal glass between them lend the glass outstanding optical properties, as do the carefully guarded handcraft techniques.

Product Classification

Name	MEMORY	WALL	
Colour	BAS	red - triplex opal blue - triplex opal orange - triplex opal light pink - triplex opal grey - triplex opal triplex opal turquoise - triplex opal green apple - triplex opal yellow - triplex opal	CGC579 CGC28 CGC580 CGC30 CGC617 CGC39 CGC601 CGC578 CGC47
SurfaceG	ALL	gloss acid-etched	CGSU66 CGSU67
SurfaceC	BAS	iron chromate	CCS620
Certification	ALL	CE EN 60598-1 EN 60598-2-1	CEC160 CEC567 CEC568

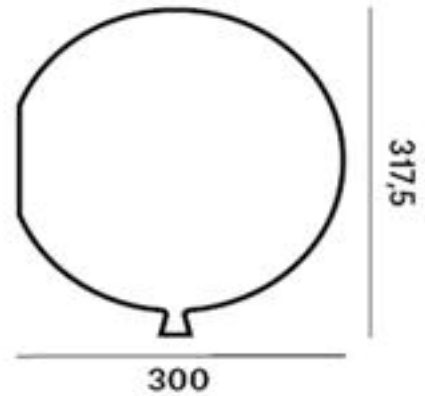

	X	Y	W	Z
PC880	300	317		146

Identification

Name	MEMORY WALL
Type	wall lamp
Collection	MEMORY
Line	Exclusive Line
Designed by	Boris Klimek

BROKIS

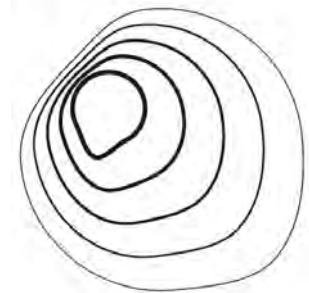

Description

Features	Playful, amusing, surprising – the Memory collection of ceiling and wall fixtures kindles the imagination and takes the beholder back to the carefree days of childhood. Three sizes and a range of colors allow you to turn your creativity loose in devising various lighting experiences. With the hanging strings serving to switch the lights on and off, there is nothing to interrupt the illusion of real balloons. This is beauty in its simplest and most effective form.
Technology	The craftsmanship applied in production follows in the centuries-old tradition and experience of master glassmakers. The precision crafting of hand-blown glass instills distinctive, enduring character and outstanding quality in all Brokis products. The glass shades are formed from multiple layers of molten glass, each of which is scrutinized by the master glassmaker prior to being blown into the mold. Up to 70% of the resulting quality is achieved in this stage of production. The triplex opal glass used in the production of the lampshade represents one of the highest quality materials used in the lighting industry. The sandwich combination of two transparent outer layers of crystal and an inner layer of white opal glass between them lend the glass outstanding optical properties, as do the carefully guarded handcraft techniques.

Product Classification

Name	MEMORY	WALL	
Colour	BAS	red - triplex opal blue - triplex opal orange - triplex opal light pink - triplex opal grey - triplex opal triplex opal turquoise - triplex opal green apple - triplex opal yellow - triplex opal	CGC579 CGC28 CGC580 CGC30 CGC617 CGC39 CGC601 CGC578 CGC47
SurfaceG	ALL	gloss acid-etched	CGSU66 CGSU67
SurfaceC	BAS	iron chromate	CCS620
Certification	ALL	CE EN 60598-1 EN 60598-2-1	CEC160 CEC567 CEC568

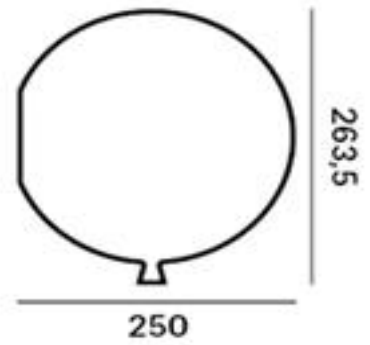

	X	Y	W	Z
PC881	250	263		146

Identification

Name	MEMORY WALL
Type	wall lamp
Collection	MEMORY
Line	Exclusive Line
Designed by	Boris Klimek

BROKIS

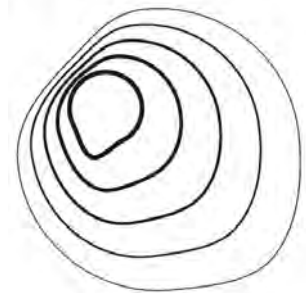

Description

Features	Playful, amusing, surprising – the Memory collection of ceiling and wall fixtures kindles the imagination and takes the beholder back to the carefree days of childhood. Three sizes and a range of colors allow you to turn your creativity loose in devising various lighting experiences. With the hanging strings serving to switch the lights on and off, there is nothing to interrupt the illusion of real balloons. This is beauty in its simplest and most effective form.
Technology	The craftsmanship applied in production follows in the centuries-old tradition and experience of master glassmakers. The precision crafting of hand-blown glass instills distinctive, enduring character and outstanding quality in all Brokis products. The glass shades are formed from multiple layers of molten glass, each of which is scrutinized by the master glassmaker prior to being blown into the mold. Up to 70% of the resulting quality is achieved in this stage of production. The triplex opal glass used in the production of the lampshade represents one of the highest quality materials used in the lighting industry. The sandwich combination of two transparent outer layers of crystal and an inner layer of white opal glass between them lend the glass outstanding optical properties, as do the carefully guarded handcraft techniques.

Product Classification

Name	MEMORY	WALL	
Colour	BAS	red - triplex opal blue - triplex opal orange - triplex opal light pink - triplex opal grey - triplex opal triplex opal turquoise - triplex opal green apple - triplex opal yellow - triplex opal	CGC579 CGC28 CGC580 CGC30 CGC617 CGC39 CGC601 CGC578 CGC47
SurfaceG	ALL	gloss acid-etched	CGSU66 CGSU67
SurfaceC	ALL	iron chromate	CCS620
Certification	ALL	CE EN 60598-1 EN 60598-2-1	CEC160 CEC567 CEC568

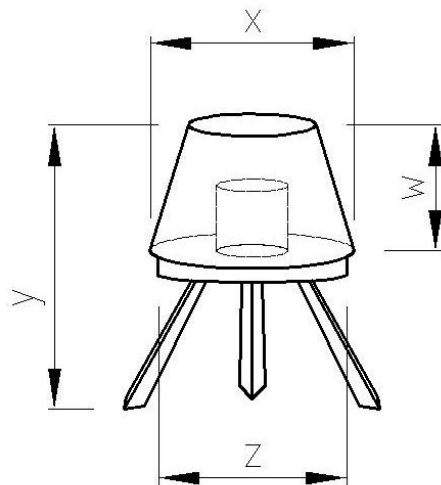

	X	y	W	Z
PC859	400	560	250	370

Identification

Name	PLANTA SMALL
Type	table lamp
Collection	PLANTA
Line	Exclusive Line
Designed by	Barbara Manolo

BROKIS

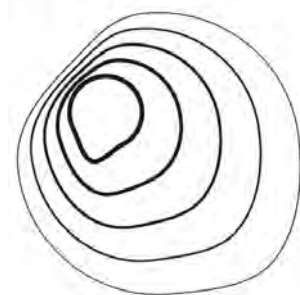

Description

Features	Liven up your favorite space with the small, shining gardens of the PLANTA collection. The multiple varieties let you cultivate creativity and entice more of the senses with an uncommon and special ambience. The lights comprise a transparent glass globe in one of four tones – transparent, apple green, amber, and violet – elegantly poised atop a hand-waxed oak tripod. They are available with or without plants and other decorations.
-----------------	--

Technology	The craftsmanship applied in production follows in the centuries-old tradition and experience of master glassmakers. The precision crafting of hand-blown glass instills distinctive, enduring character and outstanding quality in all Brokis products. The glass shades are formed from multiple layers of molten glass, each of which is scrutinized by the master glassmaker prior to being blown into the mold. Up to 70% of the resulting quality is achieved in this stage of production. No less attention to detail is paid in handcrafting the wooden elements of the light. Each piece is individually processed by the artisan in a series of strictly observed production stages. We take special care in selecting quality fine wood and ecologically friendly materials to treat it with.
-------------------	--

Product Classification

Name	PLANTA	SMALL	
Colour	BAS	amber violet - transparent transparent apple green - transparent	CGC515 CGC554 CGC23 CGC49
SurfaceG	ALL	glossv	CGSU66
SurfaceC	BAS	European Oak natural waxed	CCS518
Bulbs	ALL	E27 11W - cool white E27 11W - warm white	CEB628 CEB627
Cable colour	ALL	white black red grey transparent	CECL521 CECL519 CECL530 CECL520 CECL149
Material	ALL	carton glass	CCM140 CCM139
Certification	ALL	CE EN 60598-1 EN 60598-2-4	CEC160 CEC569 CEC570

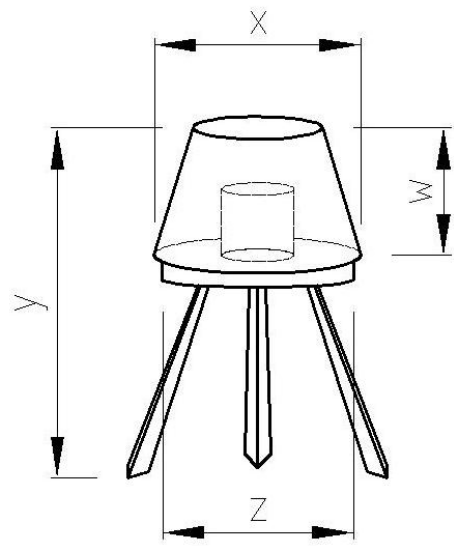

	X	Y	W	Z
PC860	400	680	250	400

Identification

Name	PLANTA MEDIUM
Type	floor lamp
Collection	PLANTA
Line	Exclusive Line
Designed by	Barbara Manolo

BROKIS

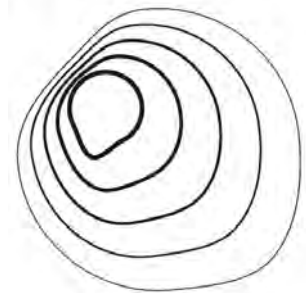

Description

Features	Liven up your favorite space with the small, shining gardens of the PLANTA collection. The multiple varieties let you cultivate creativity and entice more of the senses with an uncommon and special ambience. The lights comprise a transparent glass globe in one of four tones – transparent, apple green, amber, and violet – elegantly poised atop a hand-waxed oak tripod. They are available with or without plants and other decorations.
-----------------	--

Technology	The craftsmanship applied in production follows in the centuries-old tradition and experience of master glassmakers. The precision crafting of hand-blown glass instills distinctive, enduring character and outstanding quality in all Brokis products. The glass shades are formed from multiple layers of molten glass, each of which is scrutinized by the master glassmaker prior to being blown into the mold. Up to 70% of the resulting quality is achieved in this stage of production. No less attention to detail is paid in handcrafting the wooden elements of the light. Each piece is individually processed by the artisan in a series of strictly observed production stages. We take special care in selecting quality fine wood and ecologically friendly materials to treat it with.
-------------------	--

Product Classification

Name	PLANTA	MEDIUM	
Colour	BAS	amber violet - transparent transparent apple green - transparent	CGC515 CGC554 CGC23 CGC49
SurfaceG	ALL	glossv	CGSU66
SurfaceC	ALL	European Oak natural waxed	CCS518
Bulbs	ALL	E27 11W - cool white E27 11W - warm white	CEB628 CEB627
Cable colour	ALL	white black red grey transparent	CECL521 CECL519 CECL530 CECL520 CECL149
Certification	ALL	CE EN 60598-1 EN 60598-2-4	CEC160 CEC569 CEC570

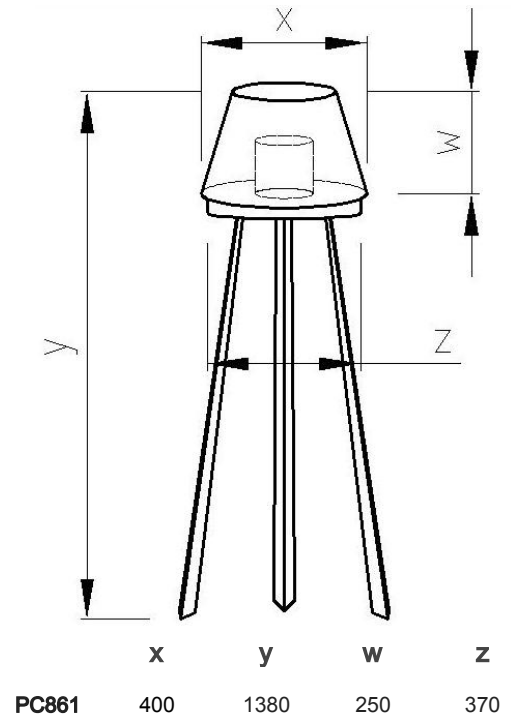

Identification

Name	PLANTA BIG
Type	floor lamp
Collection	PLANTA
Line	Exclusive Line
Designed by	Barbara Manolo

BROKIS

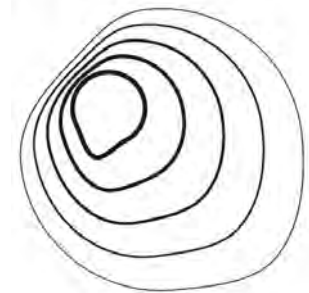

Description

Features	Liven up your favorite space with the small, shining gardens of the PLANTA collection. The multiple varieties let you cultivate creativity and entice more of the senses with an uncommon and special ambience. The lights comprise a transparent glass globe in one of four tones – transparent, apple green, amber, and violet – elegantly poised atop a hand-waxed oak tripod. They are available with or without plants and other decorations.
-----------------	--

Technology	The craftsmanship applied in production follows in the centuries-old tradition and experience of master glassmakers. The precision crafting of hand-blown glass instills distinctive, enduring character and outstanding quality in all Brokis products. The glass shades are formed from multiple layers of molten glass, each of which is scrutinized by the master glassmaker prior to being blown into the mold. Up to 70% of the resulting quality is achieved in this stage of production. No less attention to detail is paid in handcrafting the wooden elements of the light. Each piece is individually processed by the artisan in a series of strictly observed production stages. We take special care in selecting quality fine wood and ecologically friendly materials to treat it with.
-------------------	--

Product Classification

Name	PLANTA	BIG	
Colour	BAS	amber	CGC515
		violet - transparent	CGC554
		transparent	CGC23
		apple green - transparent	CGC49
SurfaceG	ALL	glossv	CGSU66
SurfaceC	ALL	European Oak natural waxed	CCS518
Bulbs	ALL	E27 11W - cool white	CEB628
		E27 11W - warm white	CEB627
Cable colour	ALL	white	CECL521
		black	CECL519
		red	CECL530
		grey	CECL520
		transparent	CECL149
Certification	ALL	CE	CEC160
		EN 60598-1	CEC569
		EN 60598-2-4	CEC570

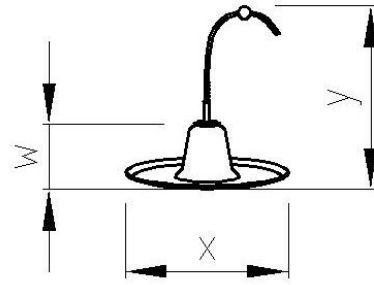
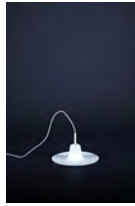

	x	y	w	z
PC872	316	285	103	

Identification

Name	BĚLL TABLE
Type	table lamp
Collection	BĚLL
Line	Exclusive Line
Designed by	Daniel Gonzalez

BROKIS

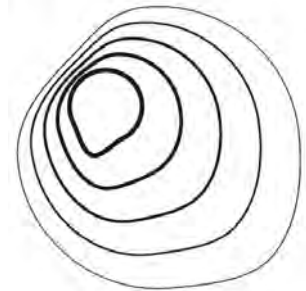

Description

Features The BĚLL – a beam of light in its purest form. The hand-blown opal glass allowed the designer to accentuate clean lines and use the unique diffusing properties of the material to create pleasant, inviting light tones. The BĚLL collection of ambient lights consists of three table lamps in different sizes and shapes and one solitary floor light.

Technology The craftsmanship applied in production follows in the centuries-old tradition and experience of master glassmakers. The precision crafting of hand-blown glass instills distinctive, enduring character and outstanding quality in all Brokis products. The glass shades are formed from multiple layers of molten glass, each of which is scrutinized by the master glassmaker prior to being blown into the mold. Up to 70% of the resulting quality is achieved in this stage of production. The triplex opal glass used in the production of the lampshade represents one of the highest quality materials used in the lighting industry. The sandwich combination of two transparent outer layers of crystal and an inner layer of white opal glass between them lend the glass outstanding optical properties, as do the carefully guarded handcraft techniques.

Product Classification

Name	BĚLL	TABLE	
Colour	BAS	triplex opal	CGC39
SurfaceG	ALL	acid-etched	CGSU67
SurfaceC	ALL	powder coating - white shiny	CCS466
Bulbs	ALL	bulb G9 LED ž 23 SMD 5050 cool white. 2.6W	CEB624
Cable colour	ALL	white	CECL521
Switch	ALL	bipolar switch	table CES100
Certification	ALL	CE EN 60598-1 EN 60598-2-4	CEC160 CEC569 CEC570

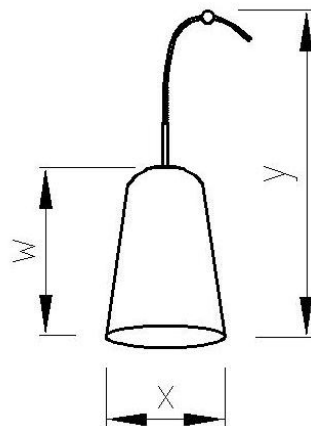

	x	y	w	z
PC873	232	512	330	

Identification

Name	BĚLL TABLE
Type	table lamp
Collection	BĚLL
Line	Exclusive Line
Designed by	Daniel Gonzalez

BROKIS

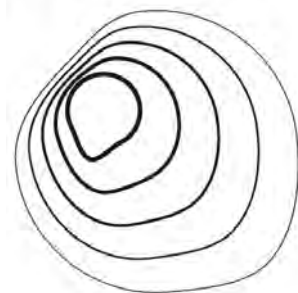

Description

Features The BĚLL – a beam of light in its purest form. The hand-blown opal glass allowed the designer to accentuate clean lines and use the unique diffusing properties of the material to create pleasant, inviting light tones. The BĚLL collection of ambient lights consists of three table lamps in different sizes and shapes and one solitary floor light.

Technology The craftsmanship applied in production follows in the centuries-old tradition and experience of master glassmakers. The precision crafting of hand-blown glass instills distinctive, enduring character and outstanding quality in all Brokis products. The glass shades are formed from multiple layers of molten glass, each of which is scrutinized by the master glassmaker prior to being blown into the mold. Up to 70% of the resulting quality is achieved in this stage of production. The triplex opal glass used in the production of the lampshade represents one of the highest quality materials used in the lighting industry. The sandwich combination of two transparent outer layers of crystal and an inner layer of white opal glass between them lend the glass outstanding optical properties, as do the carefully guarded handcraft techniques.

Product Classification

Name	BELL	TABLE	
Colour	BAS	triplex opal	CGC39
SurfaceG	ALL	acid-etched	CGSU67
SurfaceC	ALL	powder coating - white shiny	CCS466
Bulbs	ALL	PHILIPS TORNADO 20W, E27, 240V, cool white	CEB625
Cable colour	ALL	white	CECL521
Switch	ALL	bipolar switch	table CES100
Certification	ALL	CE EN 60598-1 EN 60598-2-4	CEC160 CEC569 CEC570

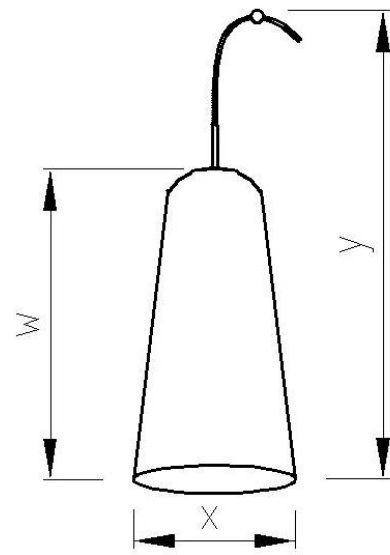

	x	y	w	z
PC874	314	782	600	

Identification

Name	BĚLL TABLE
Type	table lamp
Collection	BĚLL
Line	Exclusive Line
Designed by	Daniel Gonzalez

BROKIS

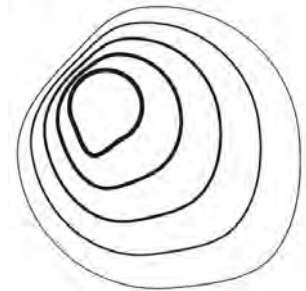

Description

Features The BĚLL – a beam of light in its purest form. The hand-blown opal glass allowed the designer to accentuate clean lines and use the unique diffusing properties of the material to create pleasant, inviting light tones. The BĚLL collection of ambient lights consists of three table lamps in different sizes and shapes and one solitary floor light.

Technology The craftsmanship applied in production follows in the centuries-old tradition and experience of master glassmakers. The precision crafting of hand-blown glass instills distinctive, enduring character and outstanding quality in all Brokis products. The glass shades are formed from multiple layers of molten glass, each of which is scrutinized by the master glassmaker prior to being blown into the mold. Up to 70% of the resulting quality is achieved in this stage of production. The triplex opal glass used in the production of the lampshade represents one of the highest quality materials used in the lighting industry. The sandwich combination of two transparent outer layers of crystal and an inner layer of white opal glass between them lend the glass outstanding optical properties, as do the carefully guarded handcraft techniques.

Product Classification

Name	BELL	TABLE	
Colour	BAS	triplex opal	CGC39
SurfaceG	ALL	acid-etched	CGSU67
SurfaceC	ALL	powder coating - white shiny	CCS466
Bulbs	ALL	PHILIPS TORNADO 23W, E27, 240V, cool white	CEB626
Cable colour	ALL	white	CECL521
Switch	ALL	bipolar switch	table CES100
Certification	ALL	CE EN 60598-1 EN 60598-2-4	CEC160 CEC569 CEC570

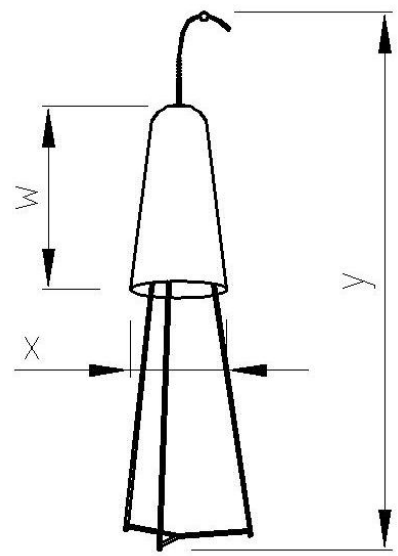
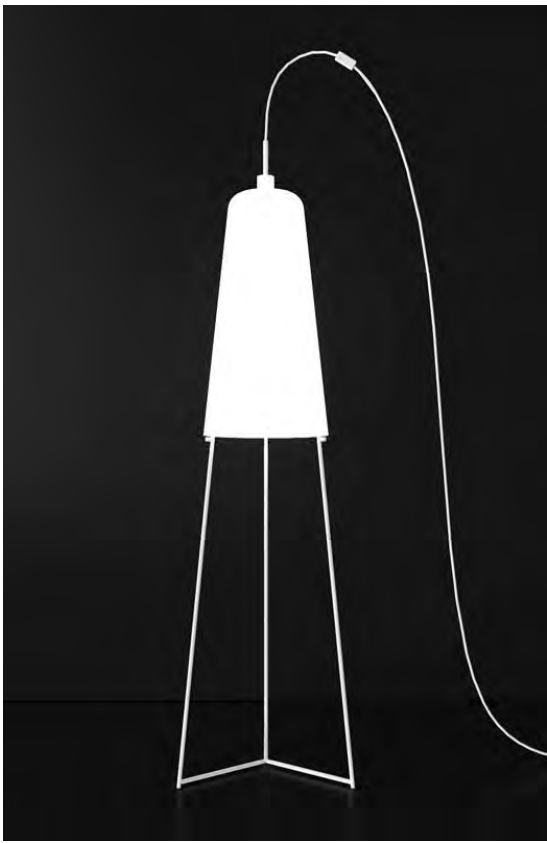

	x	y	w	z
PC875	314	1690	600	

Identification

Name	BĚLL FLOOR
Type	floor lamp
Collection	BĚLL
Line	Exclusive Line
Designed by	Daniel Gonzalez

BROKIS

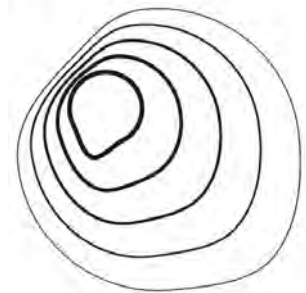

Description

Features The BĚLL – a beam of light in its purest form. The hand-blown opal glass allowed the designer to accentuate clean lines and use the unique diffusing properties of the material to create pleasant, inviting light tones. The BĚLL collection of ambient lights consists of three table lamps in different sizes and shapes and one solitary floor light.

Technology The craftsmanship applied in production follows in the centuries-old tradition and experience of master glassmakers. The precision crafting of hand-blown glass instills distinctive, enduring character and outstanding quality in all Brokis products. The glass shades are formed from multiple layers of molten glass, each of which is scrutinized by the master glassmaker prior to being blown into the mold. Up to 70% of the resulting quality is achieved in this stage of production. The triplex opal glass used in the production of the lampshade represents one of the highest quality materials used in the lighting industry. The sandwich combination of two transparent outer layers of crystal and an inner layer of white opal glass between them lend the glass outstanding optical properties, as do the carefully guarded handcraft techniques.

Product Classification

Name	BELL	FLOOR	
Colour	BAS	triplex opal	CGC39
SurfaceG	ALL	acid-etched	CGSU67
SurfaceC	ALL	powder coating - white shiny	CCS466
Bulbs	ALL	PHILIPS TORNADO 23W, E27, 240V, cool white	CEB626
Cable colour	ALL	white	CECL521
Switch	ALL	bipolar foot switch	CES154
Certification	ALL	CE EN 60598-1 EN 60598-2-4	CEC160 CEC569 CEC570

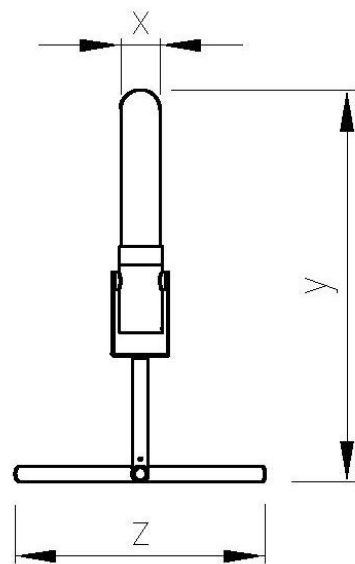

	X	Y	W	Z
PC869	55	545		347

Identification

Name	SÄTELITE TABLE
Type	table lamp
Collection	SÄTELITE
Line	Exclusive Line
Designed by	Tomáš Varga

BROKIS

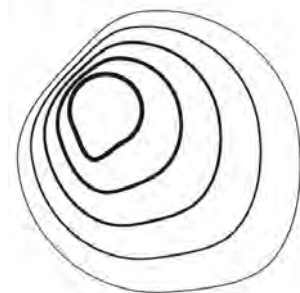

Description

Features The SÄTELITE collection, inspired by the hanging light wands often used by automobile mechanics, is ideal for those who revel in original and inventive industrial designs. Taking that inspiration a step further, the lights feature adjustable angle, height, and intensity and come in ceiling, floor, and tabletop models.

Technology The craftsmanship applied in production follows in the centuries-old tradition and experience of master glassmakers. The precision crafting of hand-blown glass instills distinctive, enduring character and outstanding quality in all Brokis products. The glass shades are formed from multiple layers of molten glass, each of which is scrutinized by the master glassmaker prior to being blown into the mold. Up to 70% of the resulting quality is achieved in this stage of production. The triplex opal glass used in the production of the lampshade represents one of the highest quality materials used in the lighting industry. The sandwich combination of two transparent outer layers of crystal and an inner layer of white opal glass between them lend the glass outstanding optical properties, as do the carefully guarded handcraft techniques.

Product Classification

Name	SÄTELITE	TABLE	
Colour	BAS	triplex opal	CGC39
SurfaceG	ALL	acid-etched	CGSU67
SurfaceC	ALL	powder coating - white shiny	CCS466
Bulbs	ALL	bulb E14 - LED 60 SMD E14 - CW	CEB577
Cable colour	ALL	white	CECL521
Switch	ALL	bipolar switch	table CES100
Certification	ALL	CE EN 60598-1 EN 60598-2-4	CEC160 CEC569 CEC570

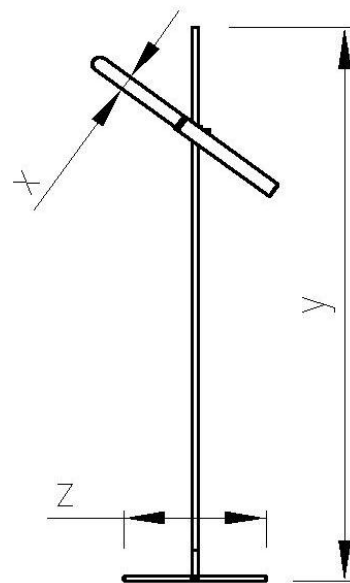
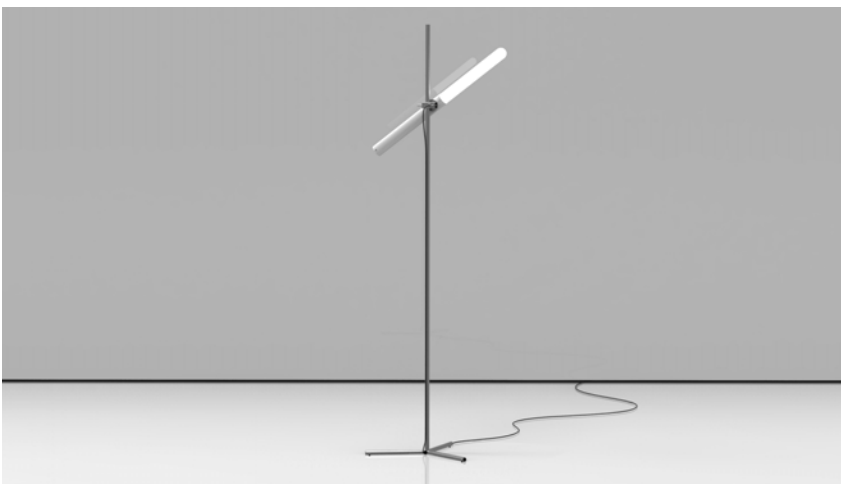

	x	y	w	z
PC870	55	2150		550

Identification

Name	SÄTELITE FLOOR
Type	floor lamp
Collection	SÄTELITE
Line	Exclusive Line
Designed by	Tomáš Varga

BROKIS

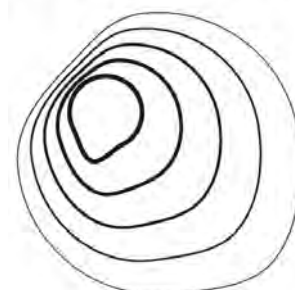

Description

Features	The SÄTELITE collection, inspired by the hanging light wands often used by automobile mechanics, is ideal for those who revel in original and inventive industrial designs. Taking that inspiration a step further, the lights feature adjustable angle, height, and intensity and come in ceiling, floor, and tabletop models.
Technology	The craftsmanship applied in production follows in the centuries-old tradition and experience of master glassmakers. The precision crafting of hand-blown glass instills distinctive, enduring character and outstanding quality in all Brokis products. The glass shades are formed from multiple layers of molten glass, each of which is scrutinized by the master glassmaker prior to being blown into the mold. Up to 70% of the resulting quality is achieved in this stage of production. The triplex opal glass used in the production of the lampshade represents one of the highest quality materials used in the lighting industry. The sandwich combination of two transparent outer layers of crystal and an inner layer of white opal glass between them lend the glass outstanding optical properties, as do the carefully guarded handcraft techniques.

Product Classification

Name	SÄTELITE	FLOOR	
Colour	BAS	triplex opal	CGC39
SurfaceG	ALL	acid-etched	CGSU67
SurfaceC	ALL	powder coating - white shiny	CCS466
Bulbs	ALL	Dulux L 36W	CEB557
Cable colour	ALL	white	CECL521
Switch	ALL	black dimmer - floor QTI 1x36W DIM bipolar switch	CES492 CES558 CES508
Certification	ALL	CE EN 60598-1 EN 60598-2-4	CEC160 CEC569 CEC570

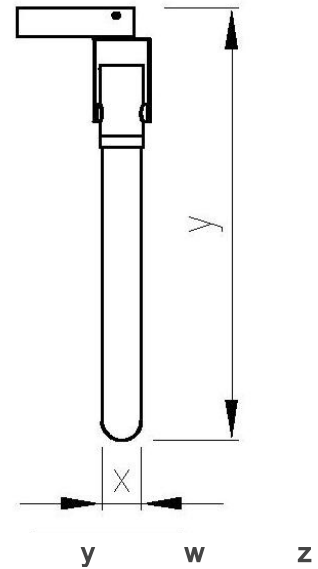

PC871

55

604

Identification

Name	SÄTELITE CEILING
Type	ceiling
Collection	SÄTELITE
Line	Exclusive Line
Designed by	Tomáš Varga

BROKIS

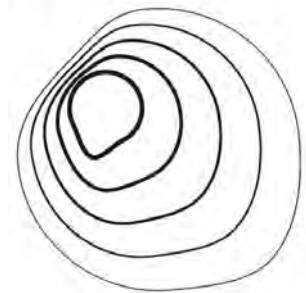

Description

Features	The SÄTELITE collection, inspired by the hanging light wands often used by automobile mechanics, is ideal for those who revel in original and inventive industrial designs. Taking that inspiration a step further, the lights feature adjustable angle, height, and intensity and come in ceiling, floor, and tabletop models.
Technology	The craftsmanship applied in production follows in the centuries-old tradition and experience of master glassmakers. The precision crafting of hand-blown glass instills distinctive, enduring character and outstanding quality in all Brokis products. The glass shades are formed from multiple layers of molten glass, each of which is scrutinized by the master glassmaker prior to being blown into the mold. Up to 70% of the resulting quality is achieved in this stage of production. The triplex opal glass used in the production of the lampshade represents one of the highest quality materials used in the lighting industry. The sandwich combination of two transparent outer layers of crystal and an inner layer of white opal glass between them lend the glass outstanding optical properties, as do the carefully guarded handcraft techniques.

Product Classification

Name	SÄTELITE	CEILING
Colour	BAS	triplex opal CGC39
SurfaceG	ALL	acid-etched CGSU67
SurfaceC	ALL	powder coating - white shiny CCS466
Bulbs	ALL	Dulux L 36W CEB557
Switch	ALL	QTP-M 1x26-42W CES559
Certification	ALL	CE EN 60598-1 EN 60598-2-1 CEC160 CEC567 CEC568

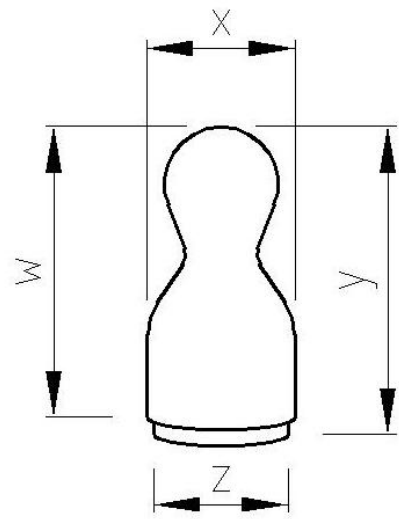

	X	Y	W	Z
PC841	128	298	267	125

Identification

Name	TEO SMALL
Type	table lamp
Collection	TEO
Line	Exclusive Line
Designed by	Michal Froněk, Jan Němeček / Olgoj Chorchoj

BROKIS

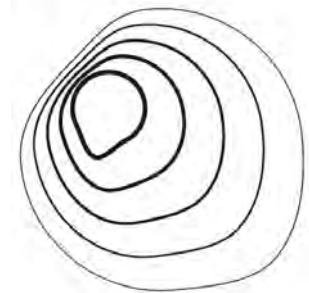

Description

Features	The universal lights of the TEO collection are a tribute to traditional Czech hand-blown glass artistry, and their simple, playful design, suitable for both private and commercial interiors, is a clear reference to the figures of the popular board game Parčeesi. The light's iconic shape will do more than captivate your visitors – it will light up their faces with a smile. TEO lights are made of hand-blown triplex opal glass and are designed in several sizes and varieties: ceiling, floor, solitary table lamp.
-----------------	---

Technology	The craftsmanship applied in production follows in the centuries-old tradition and experience of master glassmakers. The precision crafting of hand-blown glass instills distinctive, enduring character and outstanding quality in all Brokis products. The glass shades are formed from multiple layers of molten glass, each of which is scrutinized by the master glassmaker prior to being blown into the mold. Up to 70% of the resulting quality is achieved in this stage of production. The triplex opal glass used in the production of the lampshade represents one of the highest quality materials used in the lighting industry. The sandwich combination of two transparent outer layers of crystal and an inner layer of white opal glass between them lend the glass outstanding optical properties, as do the carefully guarded handcraft techniques.
-------------------	---

Product Classification

Name	TEO	SMALL	
Colour	BAS	triplex opal	CGC39
SurfaceG	ALL	glossv acid-etched	CGSU66 CGSU67
SurfaceC	ALL	powder coating - white shiny	CCS466
Bulbs	ALL	E27 11W - cool white E27 11W - warm white	CEB628 CEB627
Cable colour	ALL	white black red grey yellow	CECL521 CECL519 CECL530 CECL520 CECL606
Switch	ALL	bipolar switch	CES493
Certification	ALL	CE EN 60598-1 EN 60598-2-4	CEC160 CEC569 CEC570

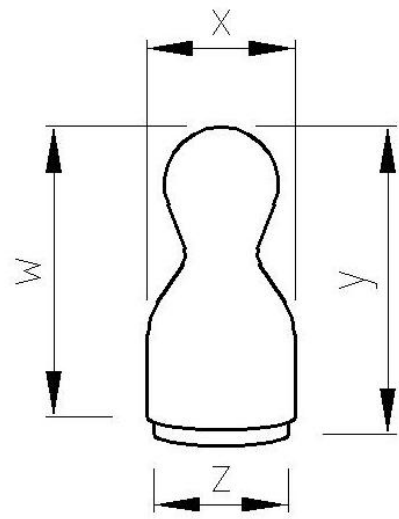

	X	Y	W	Z
PC842	182	458	428	186

Identification

Name	TEO MEDIUM
Type	table lamp
Collection	TEO
Line	Exclusive Line
Designed by	Michal Froněk, Jan Němeček / Olgoj Chorchoj

BROKIS

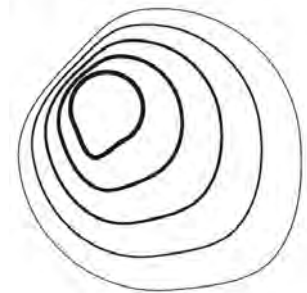

Description

Features	The universal lights of the TEO collection are a tribute to traditional Czech hand-blown glass artistry, and their simple, playful design, suitable for both private and commercial interiors, is a clear reference to the figures of the popular board game Parčeesi. The light's iconic shape will do more than captivate your visitors – it will light up their faces with a smile. TEO lights are made of hand-blown triplex opal glass and are designed in several sizes and varieties: ceiling, floor, solitary table lamp.
-----------------	---

Technology	The craftsmanship applied in production follows in the centuries-old tradition and experience of master glassmakers. The precision crafting of hand-blown glass instills distinctive, enduring character and outstanding quality in all Brokis products. The glass shades are formed from multiple layers of molten glass, each of which is scrutinized by the master glassmaker prior to being blown into the mold. Up to 70% of the resulting quality is achieved in this stage of production. The triplex opal glass used in the production of the lampshade represents one of the highest quality materials used in the lighting industry. The sandwich combination of two transparent outer layers of crystal and an inner layer of white opal glass between them lend the glass outstanding optical properties, as do the carefully guarded handcraft techniques.
-------------------	---

Product Classification

Name	TEO	MEDIUM	
Colour	BAS	triplex opal	CGC39
SurfaceG	ALL	glossv acid-etched	CGSU66 CGSU67
SurfaceC	ALL	powder coating - white shiny	CCS466
Bulbs	ALL	bulb E27 - enerav savina 11W. cool white bulb E27 - enerav savina 11W. warm white	CEB633 CEB632
Cable colour	ALL	white black red grey yellow	CECL521 CECL519 CECL530 CECL520 CECL606
Switch	ALL	bipolar switch	CES493
Certification	ALL	CE EN 60598-1 EN 60598-2-4	CEC160 CEC569 CEC570

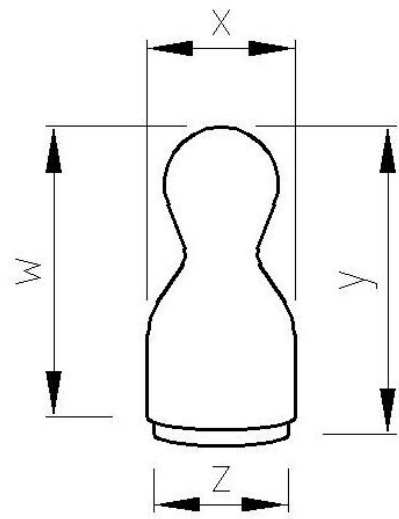

	X	Y	W	Z
PC843	275	720	692	275

Identification

Name	TEO BIG
Type	table lamp
Collection	TEO
Line	Exclusive Line
Designed by	Michal Froněk, Jan Němeček / Olgoj Chorchoj

BROKIS

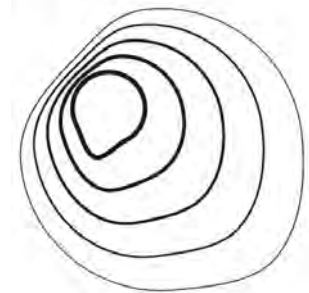

Description

Features The universal lights of the TEO collection are a tribute to traditional Czech hand-blown glass artistry, and their simple, playful design, suitable for both private and commercial interiors, is a clear reference to the figures of the popular board game Parčeesi. The light's iconic shape will do more than captivate your visitors – it will light up their faces with a smile. TEO lights are made of hand-blown triplex opal glass and are designed in several sizes and varieties: ceiling, floor, solitary table lamp.

Technology The craftsmanship applied in production follows in the centuries-old tradition and experience of master glassmakers. The precision crafting of hand-blown glass instills distinctive, enduring character and outstanding quality in all Brokis products. The glass shades are formed from multiple layers of molten glass, each of which is scrutinized by the master glassmaker prior to being blown into the mold. Up to 70% of the resulting quality is achieved in this stage of production. The triplex opal glass used in the production of the lampshade represents one of the highest quality materials used in the lighting industry. The sandwich combination of two transparent outer layers of crystal and an inner layer of white opal glass between them lend the glass outstanding optical properties, as do the carefully guarded handcraft techniques.

Product Classification

Name	TEO	BIG	
Colour	ALL	triplex opal	CGC39
SurfaceG	ALL	glossv acid-etched	CGSU66 CGSU67
SurfaceC	ALL	powder coating - white shiny	CCS466
Bulbs	BAS	bulb E27 - 20W DIM - cool white bulb E27 - 20W DIM - warm white	CEB635 CEB634
	STA	bulb E27 - 20W DIM cool white bulb E27 - 20W DIM warm white	CEB637 CEB636
Cable colour	ALL	white black red grey yellow	CECL521 CECL519 CECL530 CECL520 CECL606
Switch	ALL	biolar foot switch	CES154
Certification	ALL	CE EN 60598-1 EN 60598-2-4	CEC160 CEC569 CEC570

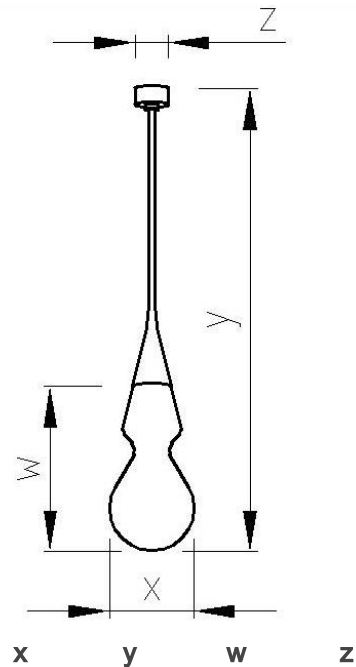

PC844	x	y	w	z
	259	individ.	506	100

Identification

Name	TEO SOSPENSIONE
Type	suspension lamp
Collection	TEO
Line	Exclusive Line
Designed by	Michal Froněk, Jan Němeček / Olgoj Chorchoj

BROKIS

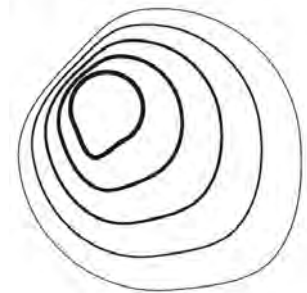

Description

Features The universal lights of the TEO collection are a tribute to traditional Czech hand-blown glass artistry, and their simple, playful design, suitable for both private and commercial interiors, is a clear reference to the figures of the popular board game Parčeesi. The light's iconic shape will do more than captivate your visitors – it will light up their faces with a smile. TEO lights are made of hand-blown triplex opal glass and are designed in several sizes and varieties: ceiling, floor, solitary table lamp.

Technology The craftsmanship applied in production follows in the centuries-old tradition and experience of master glassmakers. The precision crafting of hand-blown glass instills distinctive, enduring character and outstanding quality in all Brokis products. The glass shades are formed from multiple layers of molten glass, each of which is scrutinized by the master glassmaker prior to being blown into the mold. Up to 70% of the resulting quality is achieved in this stage of production. The triplex opal glass used in the production of the lampshade represents one of the highest quality materials used in the lighting industry. The sandwich combination of two transparent outer layers of crystal and an inner layer of white opal glass between them lend the glass outstanding optical properties, as do the carefully guarded handcraft techniques.

Product Classification

Name	TEO	SOSPENSIONE
Colour	BAS	triplex opal CGC39
SurfaceG	ALL	glossv acid-etched CGSU66 CGSU67
SurfaceC	ALL	powder coating - white shiny CCS466
Bulbs	ALL	bulb E27 - 20W DIM - cool white bulb E27 - 20W DIM - warm white CEB635 CEB634
Cable colour	ALL	transoarent CECL149
Certification	ALL	CE EN 60598-1 EN 60598-2-1 CEC160 CEC567 CEC568

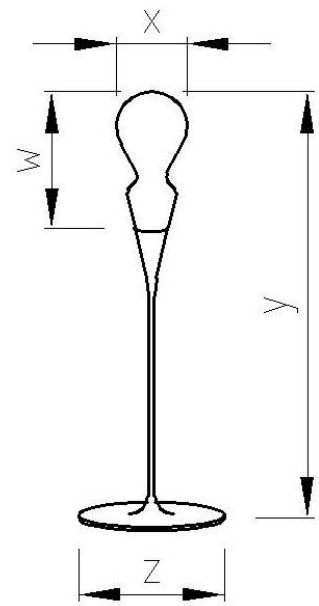

	X	Y	W	Z
PC845	259	1700	506	530

Identification

Name	TEO FLOOR
Type	floor lamp
Collection	TEO
Line	Exclusive Line
Designed by	Michal Froněk, Jan Němeček / Olgoj Chorchoj

BROKIS

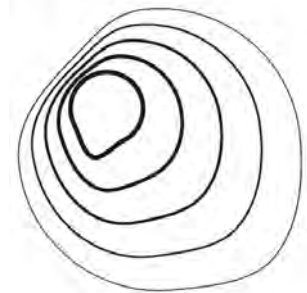

Description

Features	The universal lights of the TEO collection are a tribute to traditional Czech hand-blown glass artistry, and their simple, playful design, suitable for both private and commercial interiors, is a clear reference to the figures of the popular board game Parcheesi. The light's iconic shape will do more than captivate your visitors – it will light up their faces with a smile. TEO lights are made of hand-blown triplex opal glass and are designed in several sizes and varieties: ceiling, floor, solitary table lamp.
-----------------	--

Technology	The craftsmanship applied in production follows in the centuries-old tradition and experience of master glassmakers. The precision crafting of hand-blown glass instills distinctive, enduring character and outstanding quality in all Brokis products. The glass shades are formed from multiple layers of molten glass, each of which is scrutinized by the master glassmaker prior to being blown into the mold. Up to 70% of the resulting quality is achieved in this stage of production. The triplex opal glass used in the production of the lampshade represents one of the highest quality materials used in the lighting industry. The sandwich combination of two transparent outer layers of crystal and an inner layer of white opal glass between them lend the glass outstanding optical properties, as do the carefully guarded handcraft techniques.
-------------------	---

Product Classification

Name	TEO	FLOOR
Colour	ALL	triplex opal CGC39
SurfaceG	ALL	glossv acid-etched CGSU66 CGSU67
SurfaceC	ALL	powder coating - white shiny CCS466
Bulbs	BAS	bulb E27 - 20W DIM - cool white CEB635
	STA	bulb E27 - 20W DIM - warm white CEB634
		bulb E27 - 20W DIM cool white CEB637
		bulb E27 - 20W DIM warm white CEB636
Cable colour	ALL	white CECL521 black CECL519 red CECL530 grey CECL520 yellow CECL606
Switch	ALL	biopolar switch table CES100
Certification	ALL	CE CEC160 EN 60598-1 CEC569 EN 60598-2-4 CEC570

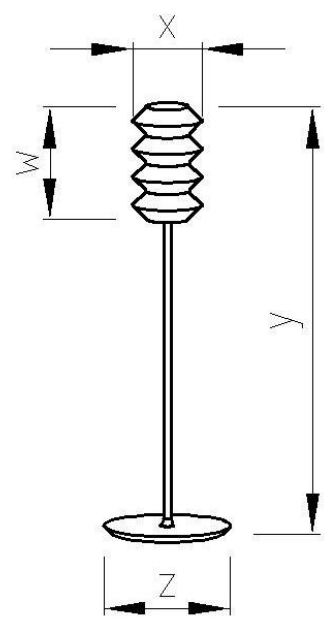
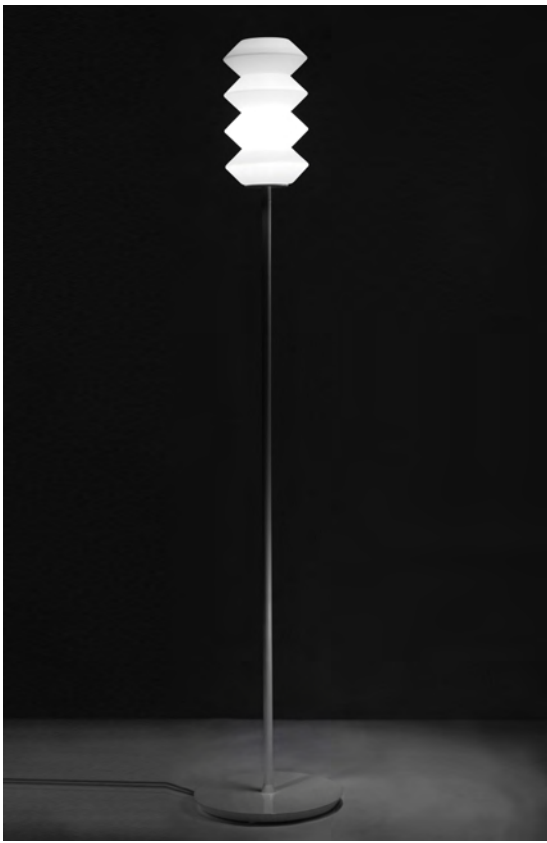

	X	Y	W	Z
PC846	192	1720	320	350

Identification

Name	ZUBATÁ FLOOR
Type	floor lamp
Collection	ZUBATÁ
Line	Exclusive Line
Designed by	Olgoj Chorchoj

BROKIS

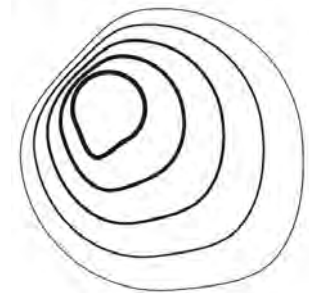

Description

Features	Stylish, luxurious, cool – three apt words to sum up the ZUBATÁ collection by prominent Czech designer Michal Froněk (Studio Olgoj Chrochoj). The lights are constructed of three layers of thin-walled opal glass, and the highly complex shaping of the outer shell is a clear demonstration of the artist's exceptional glassblowing skill. The morphology is a tribute to the product designs of the 1960's. Zubatá lights are available in white and black.
Technology	The craftsmanship applied in production follows in the centuries-old tradition and experience of master glassmakers. The precision crafting of hand-blown glass instills distinctive, enduring character and outstanding quality in all Brokis products. The glass shades are formed from multiple layers of molten glass, each of which is scrutinized by the master glassmaker prior to being blown into the mold. Up to 70% of the resulting quality is achieved in this stage of production. The triplex opal glass used in the production of the lampshade represents one of the highest quality materials used in the lighting industry. The sandwich combination of two transparent outer layers of crystal and an inner layer of white opal glass between them lend the glass outstanding optical properties, as do the carefully guarded handcraft techniques.

Product Classification

Name	ZUBATÁ	FLOOR
Colour	ALL	triplex opal CGC39
SurfaceG	ALL	glossv acid-etched CGSU66 CGSU67
SurfaceC	ALL	powder coating - white shiny CCS466
Bulbs	BAS STA	bulb E27 - 20W DIM - cool white bulb E27 - 20W DIM - warm white bulb E27 - 20W DIM warm white CEB635 CEB634 CEB636
Cable colour	ALL	transparent CECL149
Switch	BAS	bipolar foot switch CES154
Certification	ALL	CE EN 60598-1 EN 60598-2-4 CEC160 CEC569 CEC570

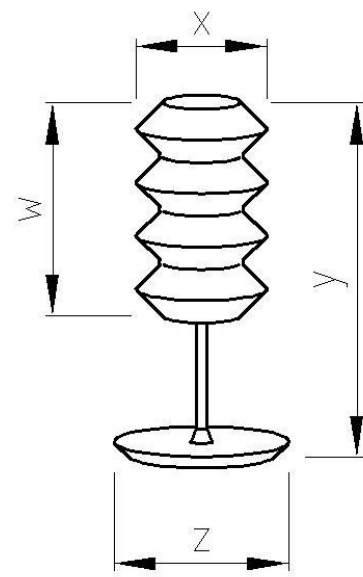

	X	Y	W	Z
PC847	192	526	320	250

Identification

Name	ZUBATÁ TABLE
Type	table lamp
Collection	ZUBATÁ
Line	Exclusive Line
Designed by	Olgoj Chorchoj

BROKIS

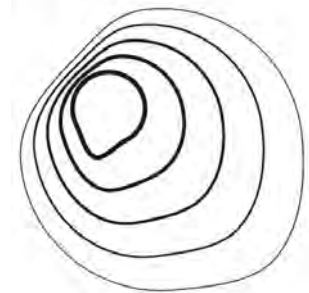

Description

Features	Stylish, luxurious, cool – three apt words to sum up the ZUBATÁ collection by prominent Czech designer Michal Froněk (Studio Olgoj Chrochoj). The lights are constructed of three layers of thin-walled opal glass, and the highly complex shaping of the outer shell is a clear demonstration of the artist's exceptional glassblowing skill. The morphology is a tribute to the product designs of the 1960's. Zubatá lights are available in white and black.
Technology	The craftsmanship applied in production follows in the centuries-old tradition and experience of master glassmakers. The precision crafting of hand-blown glass instills distinctive, enduring character and outstanding quality in all Brokis products. The glass shades are formed from multiple layers of molten glass, each of which is scrutinized by the master glassmaker prior to being blown into the mold. Up to 70% of the resulting quality is achieved in this stage of production. The triplex opal glass used in the production of the lampshade represents one of the highest quality materials used in the lighting industry. The sandwich combination of two transparent outer layers of crystal and an inner layer of white opal glass between them lend the glass outstanding optical properties, as do the carefully guarded handcraft techniques.

Product Classification

Name	ZUBATÁ	TABLE	
Colour	BAS	triplex opal	CGC39
SurfaceG	ALL	gloss acid-etched	CGSU66 CGSU67
SurfaceC	ALL	powder coating - white shiny	CCS466
Bulbs	BAS	bulb E27 -GE ENERGY SAVING 2x60W	CEB535
Cable colour	ALL	transparent	CECL149
Switch	BAS	bipolar switch	table CES100
Certification	ALL	CE EN 60598-1 EN 60598-2-4	CEC160 CEC569 CEC570

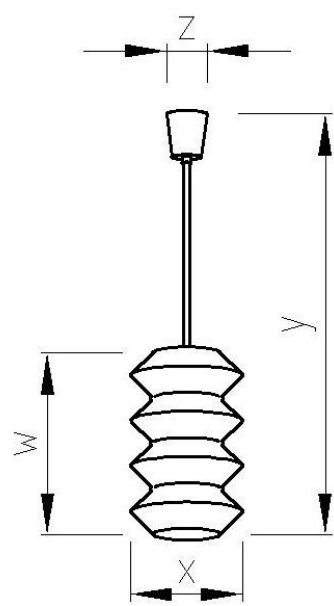

	X	Y	W	Z
PC848	192	individ.	320	70

Identification

Name	ZUBATÁ SOSPENSIONE
Type	suspension lamp
Collection	ZUBATÁ
Line	Exclusive Line
Designed by	Olgoj Chorchoj

BROKIS

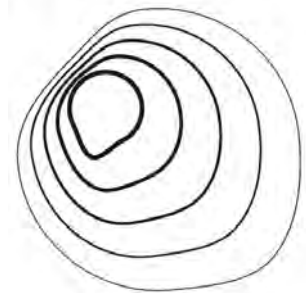

Description

Features	Stylish, luxurious, cool – three apt words to sum up the ZUBATÁ collection by prominent Czech designer Michal Froněk (Studio Olgoj Chrochoj). The lights are constructed of three layers of thin-walled opal glass, and the highly complex shaping of the outer shell is a clear demonstration of the artist's exceptional glassblowing skill. The morphology is a tribute to the product designs of the 1960's. Zubatá lights are available in white and black.
Technology	The craftsmanship applied in production follows in the centuries-old tradition and experience of master glassmakers. The precision crafting of hand-blown glass instills distinctive, enduring character and outstanding quality in all Brokis products. The glass shades are formed from multiple layers of molten glass, each of which is scrutinized by the master glassmaker prior to being blown into the mold. Up to 70% of the resulting quality is achieved in this stage of production. The triplex opal glass used in the production of the lampshade represents one of the highest quality materials used in the lighting industry. The sandwich combination of two transparent outer layers of crystal and an inner layer of white opal glass between them lend the glass outstanding optical properties, as do the carefully guarded handcraft techniques.

Product Classification

Name	ZUBATÁ	SOSPENSIONE	
Colour	BAS	triplex opal	CGC39
SurfaceG	ALL	glossv acid-etched	CGSU66 CGSU67
SurfaceC	ALL	powder coating - white shiny	CCS466
Bulbs	BAS	bulb E27 -GE ENERGY SAVING 2x60W	CEB535
Cable colour	ALL	transparent	CECL149
Certification	ALL	CE EN 60598-1 EN 60598-2-1	CEC160 CEC567 CEC568

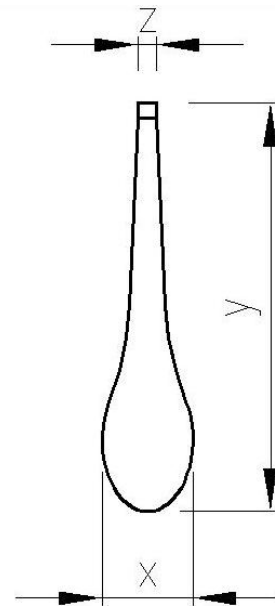

	X	Y	W	Z
PC701	max. 250	max. 2000		indivi.

Identification

Name	GOTA LUMINARIA
Type	ceiling
Collection	GOTA
Line	Profi Line
Designed by	Alex Linger

BROKIS

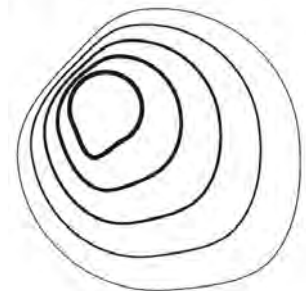

Description

Features	This hand-blown pendant light, suitable for installation in modern residential and public spaces, is designed to illuminate as well as decorate. The dominant feature of the light is its intriguing shape. The glass is produced without the use of a glass mold, its final form being gradually shaped by the glassblower.
Technology	The craftsmanship applied in production follows in the centuries-old tradition and experience of master glassmakers. The precision crafting of hand-blown glass instills distinctive, enduring character and outstanding quality in all Brokis products. The glass shades are formed from multiple layers of molten glass, each of which is scrutinized by the master glassmaker prior to being blown into the mold. Up to 70% of the resulting quality is achieved in this stage of production. The triplex opal glass used in the production of the lampshade represents one of the highest quality materials used in the lighting industry. The sandwich combination of two transparent outer layers of crystal and an inner layer of white opal glass between them lend the glass outstanding optical properties, as do the carefully guarded handcraft techniques.

Product Classification

Name	GOTA	LUMINARIA	
Colour	ALL	triplex opal	CGC39
	BAS	opal glass - height 1300 - 1600mm	CGC506
	STA	opal glass - height 1600 - 2000mm	CGC507
SurfaceG	ALL	glossv	CGSU66
SurfaceC	ALL	glossv stainless steel	CCS68
		brass	CCS69
Bulbs	ALL	individual	CEB549
Cable colour	ALL	transparent	CECL149
Material	ALL	glass	CCM139
Certification	ALL	CE	CEC160
		EN 60598-1	CEC567
		EN 60598-2-1	CEC568

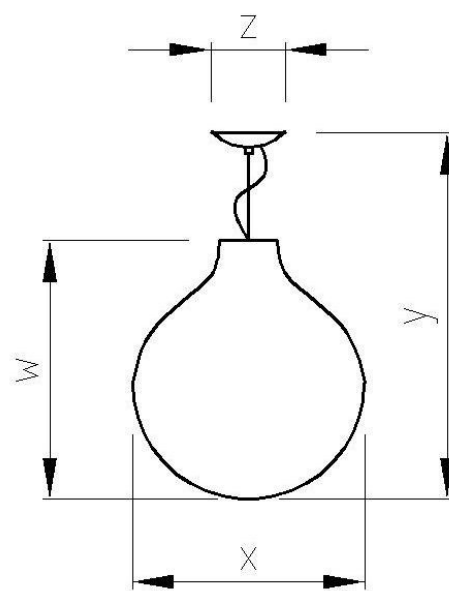

	X	Y	W	Z
PC862	450	1400	500	112

Identification

Name	MANZANA CUARTA
Type	suspension lamp
Collection	MANZANA
Line	Profi Line
Designed by	Barbara Manolo

BROKIS

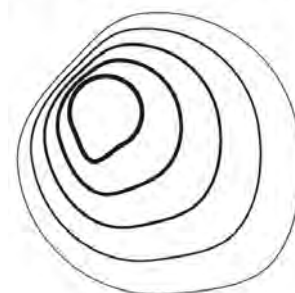

Description

Features

Only an experienced glassblower can blow a piece without using a mold. The Spanish name "manzana", apple, is precisely that and hides the very uniqueness of each piece.

Technology

Product Classification

Name	MANZANA	CUARTA	
Colour	BAS	violet - transparent transparent apple green - transparent	CGC554 CGC23 CGC49
SurfaceG	ALL	glossv	CGSU66
SurfaceC	ALL	glossv stainless steel	CCS68
Bulbs	ALL	E27 - BIAX ECO 23W 6.000 hours bulb E27 - BIAX MINI TECH. 23W 15.000 hours	CEB331 CEB326
Cable colour	ALL	transparent	CECL149
Certification	ALL	CE EN 60598-1 EN 60598-2-1	CEC160 CEC567 CEC568

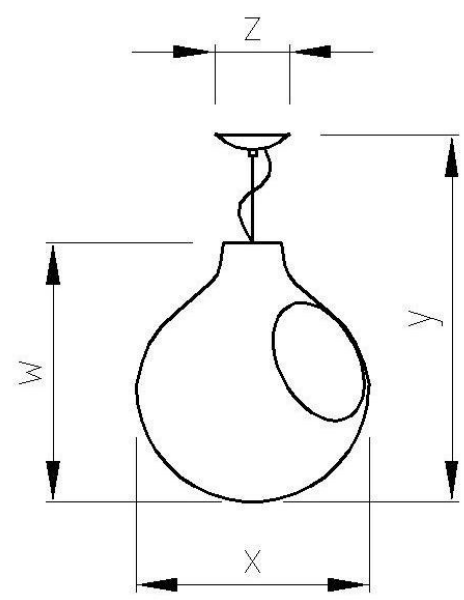

	X	Y	W	Z
PC863	450	1400	500	112

Identification

Name	SIMPLE CUARTA
Type	suspension lamp
Collection	SIMPLE
Line	Profi Line
Designed by	Barbara Manolo

BROKIS

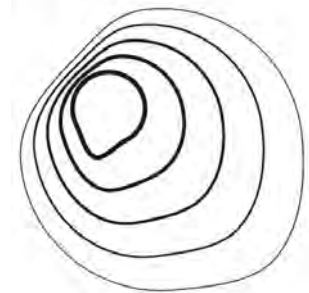

Description

Features

The SIMPLE lamp began as a modest combination of glasses of the most typical form; the hand-blown balls, which are further, cut and combined with objects. The simplicity and the originality of this lamp lie in the lighting of time and space. The lamp is supplied with or without the interior decoration.

Technology

Product Classification

Name	SIMPLE	CUARTA	
Colour	BAS	violet - transparent transparent apple green - transparent	CGC554 CGC23 CGC49
SurfaceC	ALL	glassv stainless steel	CCS68
Bulbs	ALL	E27 - BIAX ECO 23W 6.000 hours bulb E27 - BIAX MINI TECH. 23W 15.000 hours	CEB331 CEB326
Cable colour	ALL	transparent	CECL149
Certification	ALL	CE EN 60598-1 EN 60598-2-1	CEC160 CEC567 CEC568

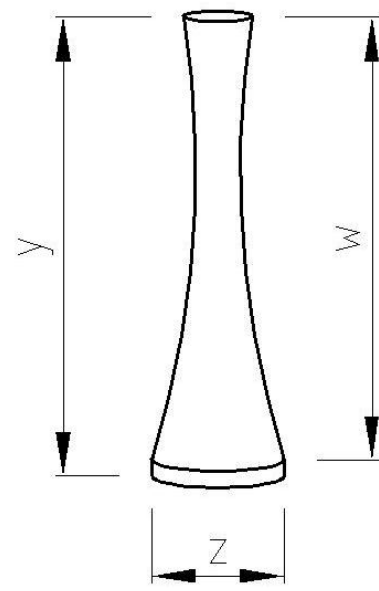

	x	y	w	z
PC714	indiv.	1410-185 0	1360-180 0	indiv.

Identification

Name	MANUEL G ROTARIO G
Type	floor lamp
Collection	MANUEL G
Line	Profi Line
Designed by	Alex Linger

BROKIS

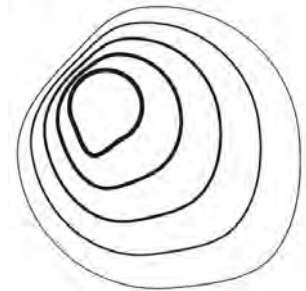

Description

Features

A floor lamp made of hand-blown opal glass. The dominant feature of this lamp is the glass, which is produced without the use of a glass mold and its final shape is gradually formed by the Master glassblower. The height of the glass ranges from 136-180 cm.

Technology

Product Classification

Name	MANUEL G	ROTARIO G
Colour	BAS	triplex opal CGC39
SurfaceG	ALL	glossv CGSU66
SurfaceC	ALL	pine-painted wood - individual CCS444 CCM511
Bulbs	ALL	bulb E27 - BIAX ECO 20W 10.000 hours bulb E27 - BIAX MINI TECH. 20W 15.000 hours bulb E27 - compatible bulb E27 -DIM enerav savina max. 20W CEB330 CEB325 CEB476 CEB491
Cable colour	ALL	transoarent CECL149
Switch	ALL	black dimmer - floor bipolar switch floor CES492 CES508
Certification	ALL	CE EN 60598-1 EN 60598-2-4 CEC160 CEC569 CEC570

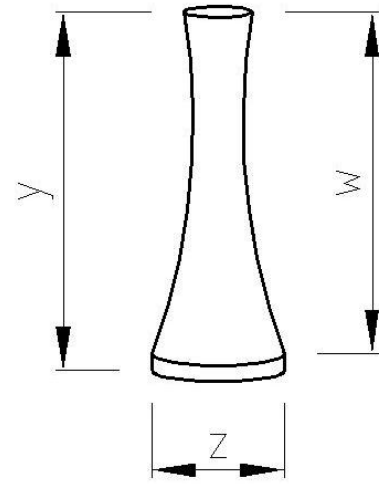

	x	y	w	z
PC713	indiv.	1100-140 ∩	1050-135 ∩	indiv.

Identification

Name	MANUEL P ROTARIO P
Type	floor lamp
Collection	MANUEL P
Line	Profi Line
Designed by	Alex Linger

BROKIS

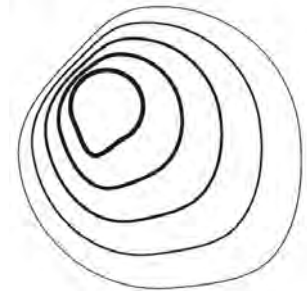

Description

Features

A floor lamp made of hand-blown opal glass. The dominant feature of this floor lamp is the glass, which is produced without the use of a glass mold and its final shape is gradually formed by the Master glassblower. The height of the glass ranges from 105-135 cm.

Technology

Product Classification

Name	MANUEL P	ROTARIO P
Colour	BAS	triplex opal CGC39
SurfaceG	ALL	glossv CGSU66
SurfaceC	ALL	pine-painted wood - individual CCS444 CCM511
Bulbs	ALL	bulb E27 - BIAX ECO 20W 10.000 hours bulb E27 - BIAX MINI TECH. 20W 15.000 hours bulb E27 - compatible bulb E27 -DIM enerav savina max. 20W CEB330 CEB325 CEB476 CEB491
Cable colour	ALL	transoarent CECL149
Switch	ALL	black dimmer - floor bipolar switch floor CES492 CES508
Certification	ALL	CE EN 60598-1 EN 60598-2-4 CEC160 CEC569 CEC570

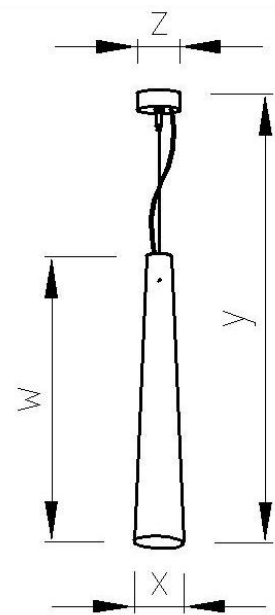
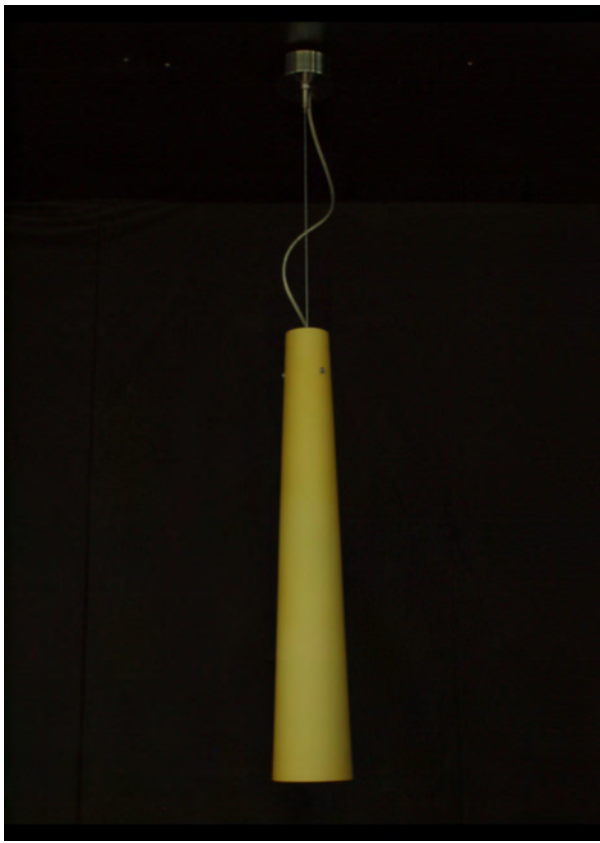

	X	Y	W	Z
PC571	120	1200	695	112

Identification

Name	ESTRELLA CUARTA
Type	suspension lamp
Collection	ESTRELLA
Line	Profi Line
Designed by	Alex Linger

BROKIS

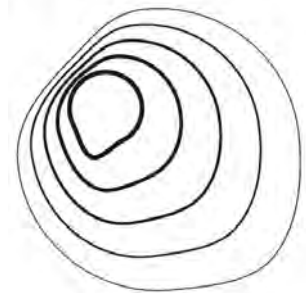

Description

Features

A pendant lamp made of hand-blown opal glass. The specific feature of this lamp is its simplicity. The fitting, together with the opal glass create a simple modern hanging lamp. This lamp can be placed in residential or public areas. The shade can be delivered in different colors according to the offer.

Technology

Product Classification

Name	ESTRELLA	CUARTA	
Colour	BAS	triplex opal	CGC39
	STA	light amber - triplex opal green apple - triplex opal	CGC41 CGC33
	ADD	black - triplex opal red dispersed	CGC36 CGC29
	SurfaceG	ALL	glossy acid-etched
Ornaments	ADD	horizontal cut vertical cut	CGO260 CGO259
	SurfaceC	ALL	glossy stainless steel glossy nickel
Bulbs	ALL	bulb E27 - compatible bulb E27 - energo savino max. 11W	CEB476 CEB490
	Cable colour	ALL	transparent
Material	ALL	metal extrusion plastics, PE, silicon	CCM135 CCM138
	Certification	ALL	CE EN 60598-1 EN 60598-2-1

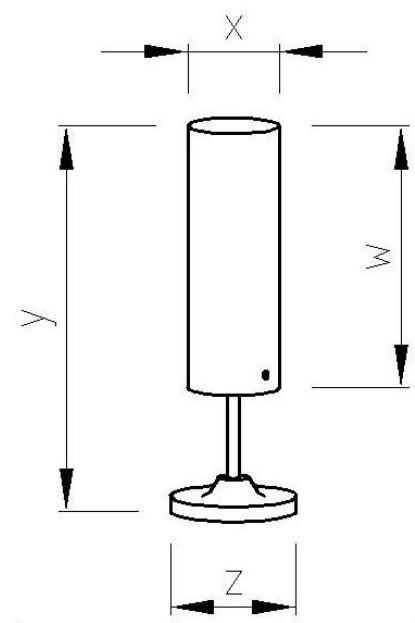

	X	Y	W	Z
PC63	120	545	380	165

Identification

Name	MELAZA OCTAVA S
Type	table lamp
Collection	MELAZA
Line	Profi Line
Designed by	Ismael Sugranes

BROKIS

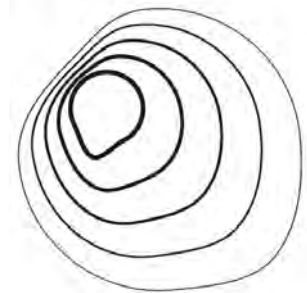

Description

Features

The collection of lamps of this series create a very pleasant atmosphere and serve as excellent decorative items. The lamps are made of four-layer hand-blown glass with "TITAN" steel decor on cognac color background. The lamps of the Melaza collection are designed in several variations: ceiling, floor and table lamps.

Technology

Product Classification

Name	MELAZA	OCTAVA	S
Colour	BAS	dark amber - triplex opal	CGC512
SurfaceG	ALL	glossv acid-etched	CGSU66 CGSU67
Ornaments	ALL	titan	CGO171
SurfaceC	ALL	glossv stainless steel wood glossv nickel	CCS68 CCS442 CCS287
Bulbs	ALL	bulb E27 - compatible	CEB476
	BAS	bulb E27 energy saving max. 11W	CEB435
	STA	bulb E27 -energy saving max. 20W	CEB475
Cable colour	ALL	transoarent	CECL149
Switch	BAS	bipolar switch	table CES100
	STA	black dimmer - table	CES474
Material	ALL	carton plastics, PE, silicon glass	CCM140 CCM138 CCM139
Certification	ALL	CE EN 60598-1 EN 60598-2-4	CEC160 CEC569 CEC570

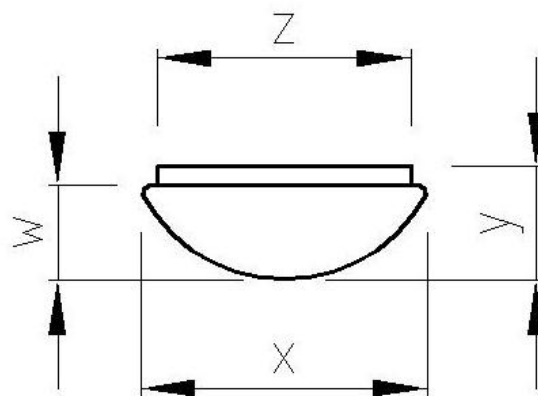

	X	Y	W	Z
PC139	250	105	103	205

Identification

Name	PLAFONIERA Plafoniera 250,290(1xE27)
Type	ceiling
Collection	PLAFONIERA
Line	Standard Line
Designed by	Alex Linger

BROKIS

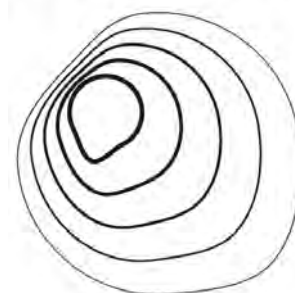

Description

Features

Handmade realization and quality design make of this series a standard feature for everyday lighting. The opal glass quality supplied by a Czech glassworks is available in diameters of 250, 290, 350, 410, 490 and 550 mm. These ceiling and wall lamps keep up with the most modern design and have a place everywhere; lounges, lobbies, corridors, staircases or residential buildings. The individual performance of the electric solutions is listed in the datasheet.

Technology

Product Classification

Name	PLAFONIE	Plafoniera 250,290(1xE27)
Colour	BAS	transparent triplex opal CGC23 CGC39
SurfaceG	BAS	glossy acid-etched CGSU66 CGSU67
Ornaments	STA	Crocodile - Blue CGO246 CGO243 CGO242 CGO244
	ADD	cut wavelets cut classic CGO375 CGO374 CGO245
SurfaceC	ALL	sheet - white, painted CCS440
Bulbs	ALL	bulb E27 - BIAX ECO 11W 6.000 hours bulb E27 - BIAX ECO 15W 10.000 hours bulb E27 - BIAX MINI TECH 11W bulb E27 - BIAX MINI TECH 9W 15.000 hours CEB328 CEB329 CEB323 CEB324
Certification	ALL	CE EN 60598-1 EN 60598-2-1 CEC160 CEC567 CEC568

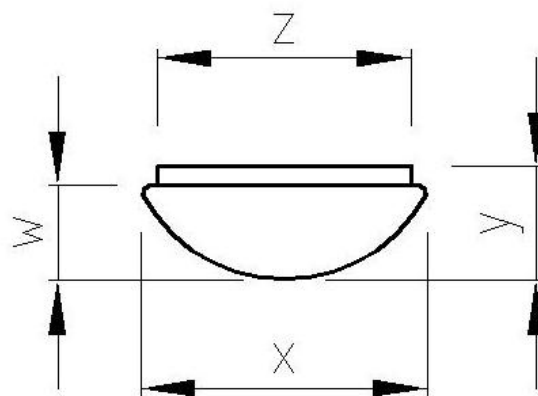

	X	Y	W	Z
PC142	290	114	112	205

Identification

Name	PLAFONIERA Plafoniera 250,290(1xE27)
Type	ceiling
Collection	PLAFONIERA
Line	Standard Line
Designed by	Alex Linger

BROKIS

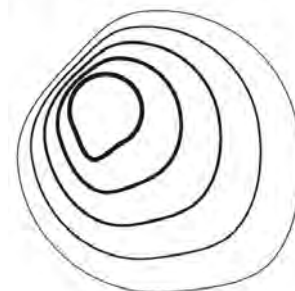

Description

Features

Handmade realization and quality design make of this series a standard feature for everyday lighting. The opal glass quality supplied by a Czech glassworks is available in diameters of 250, 290, 350, 410, 490 and 550 mm. These ceiling and wall lamps keep up with the most modern design and have a place everywhere; lounges, lobbies, corridors, staircases or residential buildings. The individual performance of the electric solutions is listed in the datasheet.

Technology

Product Classification

Name	PLAFONIE	Plafoniera 250,290(1xE27)
Colour	BAS	transparent triplex opal CGC23 CGC39
SurfaceG	BAS	glossy acid-etched CGSU66 CGSU67
Ornaments	STA	CGO246 CGO243 Crocodile - Blue CGO242 CGO244
	ADD	cut wavelets cut classic CGO375 CGO374 CGO245
Bulbs	ALL	bulb - 1x100W/MATT CEB336 bulb E27 - 1x60W/MATT CEB334 bulb E27 - BIAX ECO 11W 6.000 hours CEB328 bulb E27 - BIAX ECO 15W 10.000 hours CEB329 bulb E27 - BIAX ECO 20W 10.000 hours CEB330 E27 - BIAX ECO 23W 6.000 hours CEB331 bulb E27 - BIAX MINI TECH 11W CEB323 bulb E27 - BIAX MINI TECH 9W 15.000 hours CEB324 bulb E27 - BIAX MINI TECH. 20W 15.000 hours CEB325 bulb E27 - BIAX MINI TECH. 23W 15.000 hours CEB326 bulb E27 -1x 40W/MATT CEB333 bulb E27 -1x 75W/MATT CEB335 bulb E27 -BIAX MINI TECH 9W 15.000 CEB322
Certification	ALL	CE CEC160 EN 60598-1 CEC567 EN 60598-2-1 CEC568

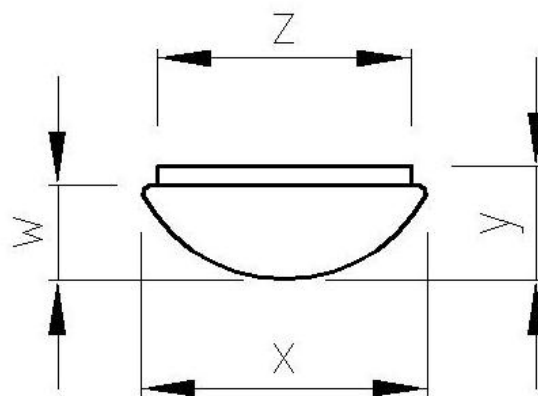

	X	Y	W	Z
PC151	350	127	125	308

Identification

Name PLAFONIERA
Plafoniera 350 (2xE27)

Type ceiling
Collection PLAFONIERA
Line Standard Line
Designed by Alex Linger

BROKIS

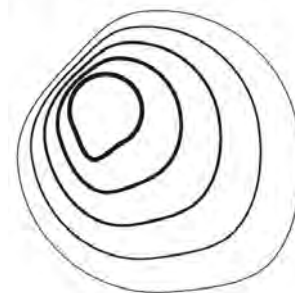

Description

Features

Handmade realization and quality design make of this series a standard feature for everyday lighting. The opal glass quality supplied by a Czech glassworks is available in diameters of 250, 290, 350, 410, 490 and 550 mm. These ceiling and wall lamps keep up with the most modern design and have a place everywhere; lounges, lobbies, corridors, staircases or residential buildings. The individual performance of the electric solutions is listed in the datasheet.

Technology

Product Classification

Name	PLAFONIE	Plafoniera 350 (2xE27)	
Colour	BAS	transparent	CGC23
SurfaceG	BAS	glossy acid-etched	CGSU66 CGSU67
Ornaments	STA		CGO246 CGO243 Crocodile - Blue CGO242 CGO244
	ADD	cut wavelets cut classic	CGO375 CGO374 CGO245
Bulbs	ALL	bulb E27 - 1x60W/MATT bulb E27 - BIAX ECO 11W 6.000 hours bulb E27 - BIAX MINI TECH 11W bulb E27 -1x 40W/MATT bulb E27 -1x 75W/MATT bulb E27 -BIAX ECO 9W 6.000 hours bulb E27 -BIAX MINI TECH 9W 15.000	CEB334 CEB328 CEB323 CEB333 CEB335 CEB327 CEB322
Certification	ALL	CE EN 60598-1 EN 60598-2-1	CEC160 CEC567 CEC568

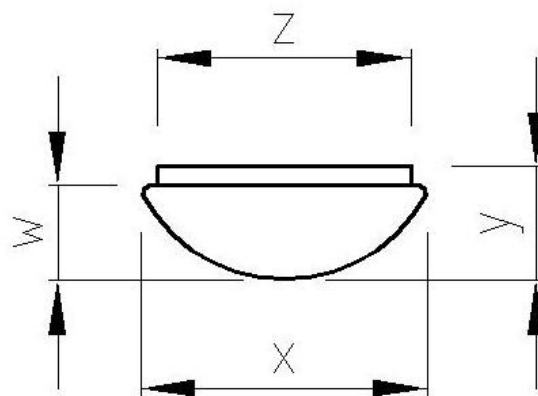

	X	Y	W	Z
PC152	350	127	125	308

Identification

Name	PLAFONIERA Plafoniera 350 (1xE27)
Type	ceiling
Collection	PLAFONIERA
Line	Standard Line
Designed by	Alex Linger

BROKIS

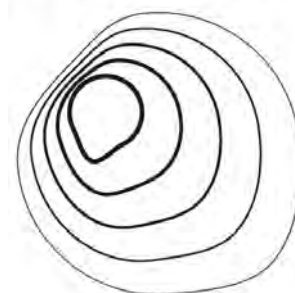

Description

Features

Handmade realization and quality design make of this series a standard feature for everyday lighting. The opal glass quality supplied by a Czech glassworks is available in diameters of 250, 290, 350, 410, 490 and 550 mm. These ceiling and wall lamps keep up with the most modern design and have a place everywhere; lounges, lobbies, corridors, staircases or residential buildings. The individual performance of the electric solutions is listed in the datasheet.

Technology

Product Classification

Name	PLAFONIE	Plafoniera 350 (1xE27)
Colour	BAS	transparent triplex opal CGC23 CGC39
SurfaceG	BAS	glossy acid-etched CGSU66 CGSU67
Ornaments	STA	CGO246 CGO243 Crocodile - Blue CGO242 CGO244
	ADD	cut wavelets cut classic CGO375 CGO374 CGO245
Bulbs	ALL	bulb - 1x100W/MATT CEB336 bulb E27 - 1x60W/MATT CEB334 bulb E27 - BIAX ECO 11W 6.000 hours CEB328 bulb E27 - BIAX ECO 15W 10.000 hours CEB329 bulb E27 - BIAX ECO 20W 10.000 hours CEB330 E27 - BIAX ECO 23W 6.000 hours CEB331 bulb E27 - BIAX MINI TECH 11W CEB323 bulb E27 - BIAX MINI TECH 9W 15.000 hours CEB324 bulb E27 - BIAX MINI TECH. 20W 15.000 hours CEB325 bulb E27 - BIAX MINI TECH. 23W 15.000 hours CEB326 bulb E27 -1x 40W/MATT CEB333 bulb E27 -1x 75W/MATT CEB335 bulb E27 -BIAX ECO 9W 6.000 hours CEB327 bulb E27 -BIAX MINI TECH 9W 15.000 CEB322
Certification	ALL	CE CEC160 EN 60598-1 CEC567 EN 60598-2-1 CEC568

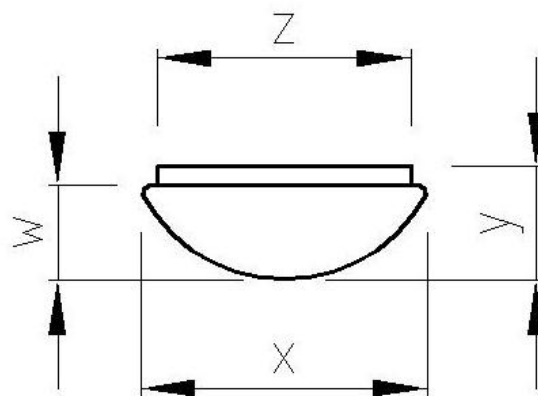

	X	Y	W	Z
PC163	410	132	130	308

Identification

Name PLAFONIERA
Plafoniera 410 (2xE27)

Type ceiling
Collection PLAFONIERA
Line Standard Line
Designed by Alex Linger

BROKIS

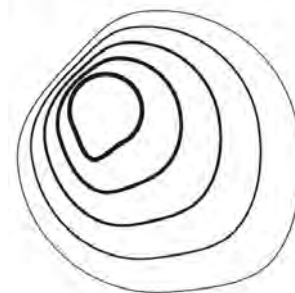

Description

Features

Handmade realization and quality design make of this series a standard feature for everyday lighting. The opal glass quality supplied by a Czech glassworks is available in diameters of 250, 290, 350, 410, 490 and 550 mm. These ceiling and wall lamps keep up with the most modern design and have a place everywhere; lounges, lobbies, corridors, staircases or residential buildings. The individual performance of the electric solutions is listed in the datasheet.

Technology

Product Classification

Name	PLAFONIE	Plafoniera 410 (2xE27)
Colour	BAS	transparent triplex opal CGC23 CGC39
SurfaceG	BAS	glossy acid-etched CGSU66 CGSU67
Ornaments	STA	CGO246 CGO243 Crocodile - Blue CGO242 CGO244
	ADD	cut wavelets cut classic CGO375 CGO374 CGO245
Bulbs	ALL	bulb E27 - 1x60W/MATT CEB334 bulb E27 - BIAX ECO 11W 6.000 hours CEB328 bulb E27 - BIAX ECO 15W 10.000 hours CEB329 bulb E27 - BIAX ECO 20W 10.000 hours CEB330 E27 - BIAX ECO 23W 6.000 hours CEB331 bulb E27 - BIAX MINI TECH 11W CEB323 bulb E27 - BIAX MINI TECH 9W 15.000 hours CEB324 bulb E27 - BIAX MINI TECH. 20W 15.000 hours CEB325 bulb E27 - BIAX MINI TECH. 23W 15.000 hours CEB326 bulb E27 - 1x 40W/MATT CEB333 bulb E27 - 1x 75W/MATT CEB335 bulb E27 - BIAX ECO 9W 6.000 hours CEB327 bulb E27 - BIAX MINI TECH 9W 15.000 CEB322
Certification	ALL	CE CEC160 EN 60598-1 CEC567 EN 60598-2-1 CEC568

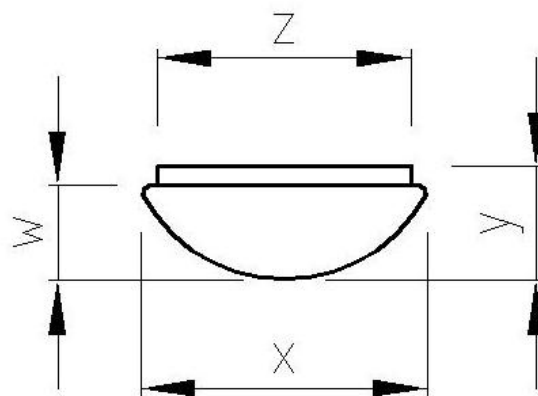

	X	Y	W	Z
PC173	490	142	140	355

Identification

Name	PLAFONIERA plafoniera 490 (3xE27)
Type	ceiling
Collection	PLAFONIERA
Line	Standard Line
Designed by	Alex Linger

BROKIS

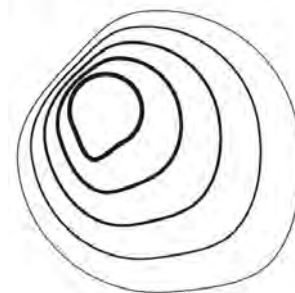

Description

Features

Handmade realization and quality design make of this series a standard feature for everyday lighting. The opal glass quality supplied by a Czech glassworks is available in diameters of 250, 290, 350, 410, 490 and 550 mm. These ceiling and wall lamps keep up with the most modern design and have a place everywhere; lounges, lobbies, corridors, staircases or residential buildings. The individual performance of the electric solutions is listed in the datasheet.

Technology

Product Classification

Name	PLAFONIE	plafoniera 490 (3xE27)
Colour	BAS	transparent triplex opal CGC23 CGC39
SurfaceG	BAS	glossy acid-etched CGSU66 CGSU67
Ornaments	STA	CGO246 CGO243 Crocodile - Blue CGO242 CGO244
	ADD	cut wavelets cut classic CGO375 CGO374 CGO245
Bulbs	ALL	bulb E27 - 1x60W/MATT CEB334 bulb E27 - BIAX ECO 11W 6.000 hours CEB328 bulb E27 - BIAX ECO 15W 10.000 hours CEB329 bulb E27 - BIAX ECO 20W 10.000 hours CEB330 bulb E27 - BIAX MINI TECH 11W CEB323 bulb E27 - BIAX MINI TECH 9W 15.000 hours CEB324 bulb E27 - BIAX MINI TECH. 20W 15.000 hours CEB325 bulb E27 - 1x 40W/MATT CEB333 bulb E27 - BIAX ECO 9W 6.000 hours CEB327 bulb E27 - BIAX MINI TECH 9W 15.000 CEB322
Certification	ALL	CE CEC160 EN 60598-1 CEC567 EN 60598-1 CEC567 EN 60598-2-1 CEC568 EN 60598-2-1 CEC568

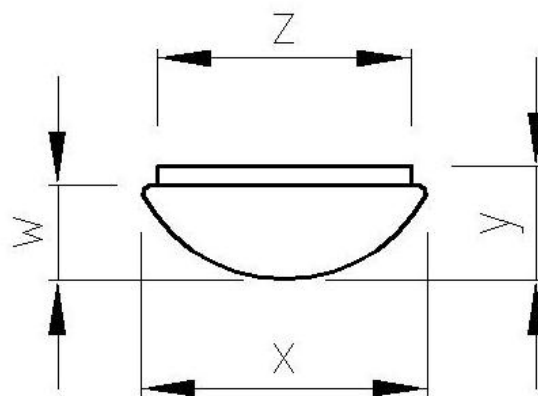

	X	Y	W	Z
PC180	550	152	150	355

Identification

Name **PLAFONIERA**
Plafoniera 550 (3xE27)

BROKIS

Type ceiling
Collection PLAFONIERA
Line Standard Line
Designed by Alex Linger

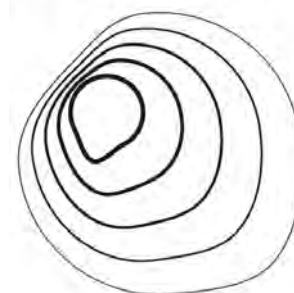

Description

Features

Handmade realization and quality design make of this series a standard feature for everyday lighting. The opal glass quality supplied by a Czech glassworks is available in diameters of 250, 290, 350, 410, 490 and 550 mm. These ceiling and wall lamps keep up with the most modern design and have a place everywhere; lounges, lobbies, corridors, staircases or residential buildings. The individual performance of the electric solutions is listed in the datasheet.

Technology

Product Classification

Name	PLAFONIE	Plafoniera 550 (3xE27)	
Colour	BAS	transparent triplex opal	CGC23 CGC39
SurfaceG	BAS	glossv acid-etched	CGSU66 CGSU67
Ornaments	ADD	cut wavelets cut classic	CGO375 CGO374
Bulbs	ALL	bulb - 1x100W/MATT bulb E27 - 1x60W/MATT bulb E27 - BIAX ECO 11W 6.000 hours bulb E27 - BIAX ECO 15W 10.000 hours bulb E27 - BIAX ECO 20W 10.000 hours E27 - BIAX ECO 23W 6.000 hours bulb E27 - BIAX MINI TECH 11W bulb E27 - BIAX MINI TECH 9W 15.000 hours bulb E27 - BIAX MINI TECH. 20W 15.000 hours bulb E27 - BIAX MINI TECH. 23W 15.000 hours bulb E27 - 1x 40W/MATT bulb E27 - 1x 75W/MATT bulb E27 - BIAX ECO 9W 6.000 hours bulb E27 - BIAX MINI TECH 9W 15.000	CEB336 CEB334 CEB328 CEB329 CEB330 CEB331 CEB323 CEB324 CEB325 CEB326 CEB333 CEB335 CEB327 CEB322
Certification	ALL	CE EN 60598-1 EN 60598-2-1	CEC160 CEC567 CEC568

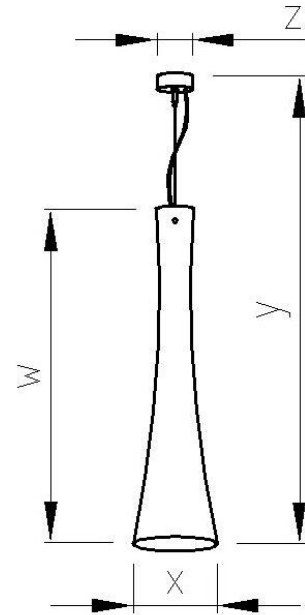

	X	Y	W	Z
PC574	250	1500	1000	112

Identification

Name	STELLA G CUARTA
Type	suspension lamp
Collection	STELLA G
Line	Standard Line
Designed by	Petra Mann

BROKIS

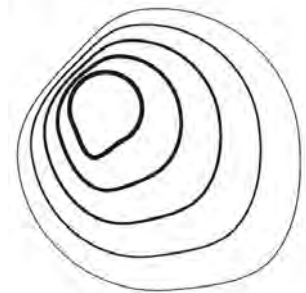

Description

Features

This is a pendant lamp made of four-layer hand-blown matt or shiny opal glass. A specific feature of this lamp is its simplicity. The fitting, together with the opal glass creates a simple modern lamp. This lamp may find its place in residential or public space. The customer may choose the color of the glass from the glass color offer.

Technology

Product Classification

Name	STELLA G	CUARTA	
Colour	BAS	triplex opal	CGC39
	STA	light amber - triplex opal	CGC41
SurfaceG	ALL	glossy	CGSU66
		acid-etched	CGSU67
SurfaceC	ALL	glossy stainless steel	CCS68
		stainless steel	CCS288
		glossy nickel	CCS287
Bulbs	ALL	bulb E27 - compatible	CEB476
		bulb E27 - energy saving max. 11W	CEB490
Cable colour	ALL	transparent	CECL149
Material	ALL	carbon	CCM140
		metal extrusion	CCM135
		plastics, PE, silicon	CCM138
		glass	CCM139
Certification	ALL	CE	CEC160
		EN 60598-1	CEC567
		EN 60598-2-1	CEC568

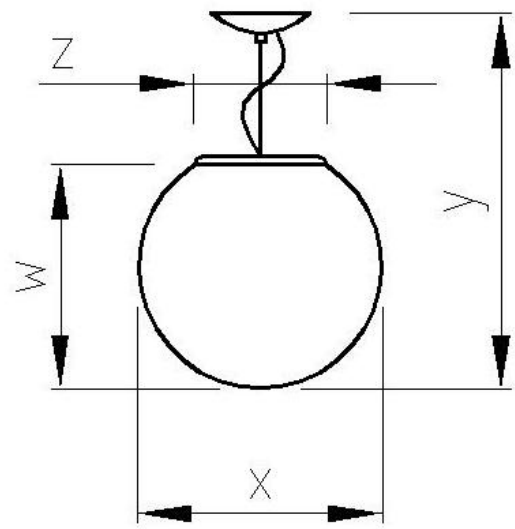

	X	Y	W	Z
PC223	120	1309	109	97

Identification

Name	ESFERA LUMÉ
Type	suspension lamp
Collection	ESFERA
Line	Standard Line
Designed by	Alex Linger

BROKIS

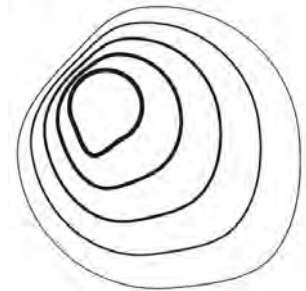

Description

Features

The Lamps from the ESFERA collection are made of triplex opal glass and are suitable for modern interior lighting in living rooms, halls, public places, etc. The suspension fitting can be delivered in four pendant variations. The construction of the hinge allows for the setting of the shade at any height.

Technology

Product Classification

Name	ESFERA	LUMÉ
Colour	BAS	triplex opal CGC39
SurfaceG	ALL	glossy acid-etched CGSU66 CGSU67
SurfaceC	ALL	chrome glossy nickel CCS275 CCS287
Bulbs	ALL	bulb E27 - BIAX ECO 11W 6.000 hours bulb E27 - BIAX MINI TECH 11W bulb E27 - compatible bulb HALOPIN G9 max. 1x60W CEB328 CEB323 CEB476 CEB411
Cable colour	ALL	transparent CECL149
Material	ALL	plastics, PE, silicon glass CCM138 CCM139
Certification	ALL	CE EN 60598-1 EN 60598-2-1 CEC160 CEC567 CEC568

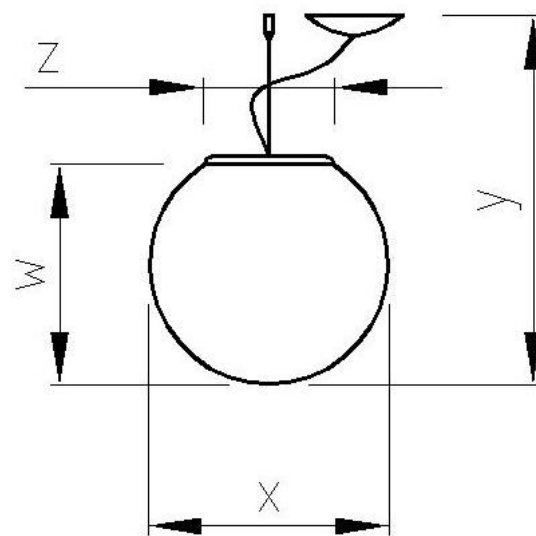

	X	Y	W	Z
PC224	120	1309	109	97

Identification

Name	ESFERA LUMÉ
Type	suspension lamp
Collection	ESFERA
Line	Standard Line
Designed by	Alex Linger

BROKIS

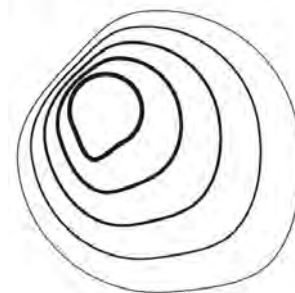

Description

Features

The Lamps from the ESFERA collection are made of triplex opal glass and are suitable for modern interior lighting in living rooms, halls, public places, etc. The suspension fitting can be delivered in four pendant variations. The construction of the hinge allows for the setting of the shade at any height.

Technology

Product Classification

Name	ESFERA	LUMÉ
Colour	BAS	triplex opal CGC39
SurfaceG	ALL	glossy acid-etched CGSU66 CGSU67
SurfaceC	ALL	chrome glossy nickel CCS275 CCS287
Bulbs	ALL	bulb E27 - BIAX ECO 11W 6.000 hours bulb E27 - BIAX MINI TECH 11W bulb E27 - compatible bulb HALOPIN G9 max. 1x60W CEB328 CEB323 CEB476 CEB411
Cable colour	ALL	transparent CECL149
Material	ALL	plastics, PE, silicon glass CCM138 CCM139
Certification	ALL	CE EN 60598-1 EN 60598-2-1 CEC160 CEC567 CEC568

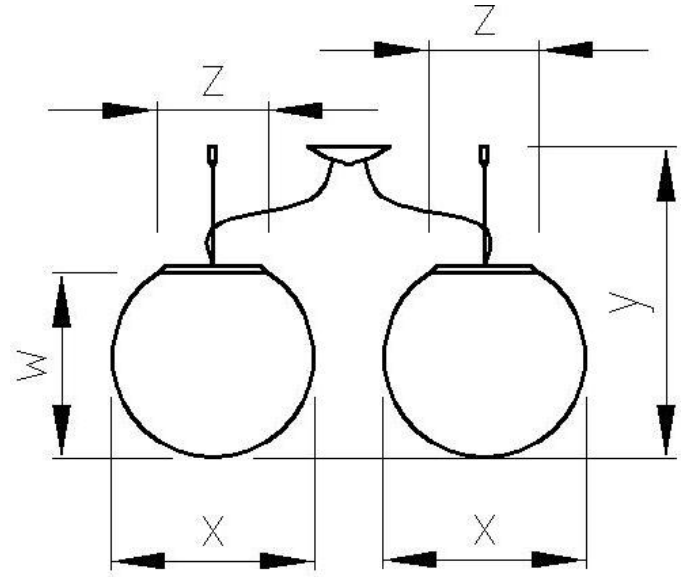

	x	y	w	z
PC225	120	1309	109	97

Identification

Name	ESFERA LUMÉ DUO
Type	suspension lamp
Collection	ESFERA
Line	Standard Line
Designed by	Alex Linger

BROKIS

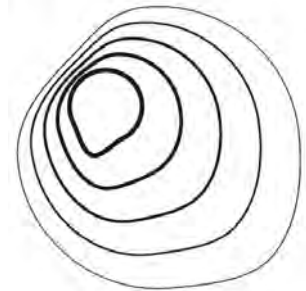

Description

Features

The Lamps from the ESFERA collection are made of triplex opal glass and are suitable for modern interior lighting in living rooms, halls, public places, etc. The suspension fitting can be delivered in four pendant variations. The construction of the hinge allows for the setting of the shade at any height.

Technology

Product Classification

Name	ESFERA	LUMÉ DUO
Colour	BAS	triplex opal CGC39
SurfaceG	ALL	glossy acid-etched CGSU66 CGSU67
SurfaceC	ALL	chrome glossy nickel CCS275 CCS287
Bulbs	ALL	bulb E27 - BIAX ECO 11W 6.000 hours bulb E27 - BIAX MINI TECH 11W bulb E27 - compatible bulb HALOPIN G9 max. 2x60W CEB328 CEB323 CEB476 CEB410
Cable colour	ALL	transparent CECL149
Material	ALL	plastics, PE, silicon glass CCM138 CCM139
Certification	ALL	CE EN 60598-1 EN 60598-2-1 CEC160 CEC567 CEC568

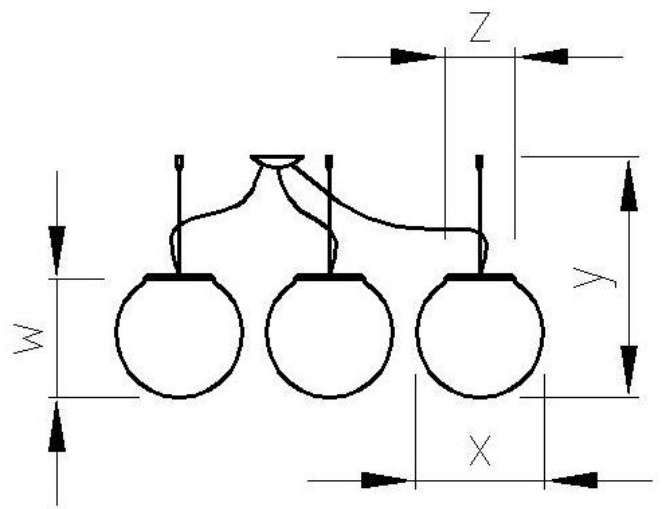

	X	Y	W	Z
PC226	120	1309	109	97

Identification

Name	ESFERA LUMÉ TRIO
Type	suspension lamp
Collection	ESFERA
Line	Standard Line
Designed by	Alex Linger

BROKIS

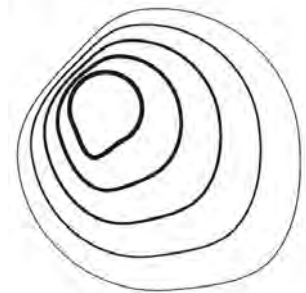

Description

Features

The Lamps from the ESFERA collection are made of triplex opal glass and are suitable for modern interior lighting in living rooms, halls, public places, etc. The suspension fitting can be delivered in four pendant variations. The construction of the hinge allows for the setting of the shade at any height.

Technology

Product Classification

Name	ESFERA	LUMÉ TRIO
Colour	BAS	triplex opal CGC39
SurfaceG	ALL	glossy acid-etched CGSU66 CGSU67
SurfaceC	ALL	chrome glossy nickel CCS275 CCS287
Bulbs	ALL	bulb E27 - BIAX ECO 11W 6.000 hours bulb E27 - BIAX MINI TECH 11W bulb E27 - compatible bulb HALOPIN G9 max. 3x60W CEB328 CEB323 CEB476 CEB409
Cable colour	ALL	transparent CECL149
Material	ALL	plastics, PE, silicon glass CCM138 CCM139
Certification	ALL	CE EN 60598-1 EN 60598-2-1 CEC160 CEC567 CEC568

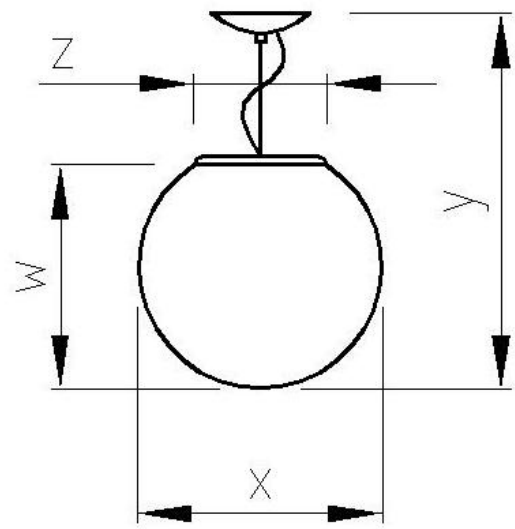

	X	Y	W	Z
PC227	150	1340	140	97

Identification

Name	ESFERA LUMÉ
Type	suspension lamp
Collection	ESFERA
Line	Standard Line
Designed by	Alex Linger

BROKIS

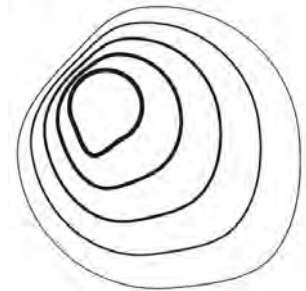

Description

Features

The Lamps from the ESFERA collection are made of triplex opal glass and are suitable for modern interior lighting in living rooms, halls, public places, etc. The suspension fitting can be delivered in four pendant variations. The construction of the hinge allows for the setting of the shade at any height.

Technology

Product Classification

Name	ESFERA	LUMÉ
Colour	BAS	triplex opal CGC39
SurfaceG	ALL	glossy acid-etched CGSU66 CGSU67
SurfaceC	ALL	chrome glossy nickel CCS275 CCS287
Bulbs	ALL	bulb E27 - BIAX ECO 11W 6.000 hours bulb E27 - BIAX MINI TECH 11W bulb E27 - compatible bulb HALOPIN G9 max. 1x60W CEB328 CEB323 CEB476 CEB411
Cable colour	ALL	transparent CECL149
Material	ALL	plastics, PE, silicon glass CCM138 CCM139
Certification	ALL	CE EN 60598-1 EN 60598-2-1 CEC160 CEC567 CEC568

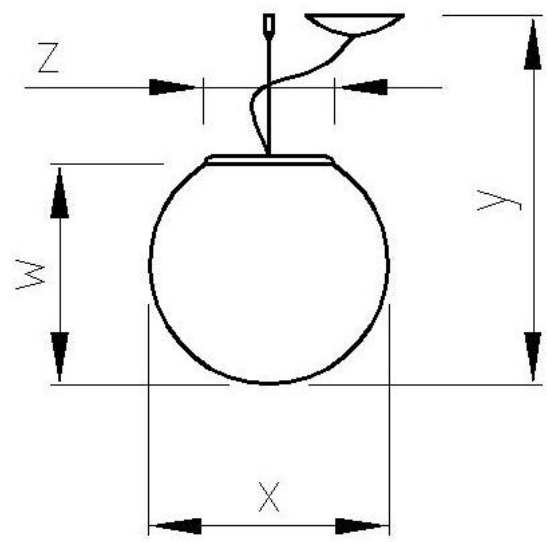

	X	Y	W	Z
PC228	150	1340	140	97

Identification

Name	ESFERA LUMÉ
Type	suspension lamp
Collection	ESFERA
Line	Standard Line
Designed by	Alex Linger

BROKIS

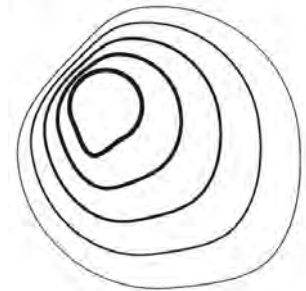

Description

Features

The Lamps from the ESFERA collection are made of triplex opal glass and are suitable for modern interior lighting in living rooms, halls, public places, etc. The suspension fitting can be delivered in four pendant variations. The construction of the hinge allows for the setting of the shade at any height.

Technology

Product Classification

Name	ESFERA	LUMÉ
Colour	BAS	triplex opal CGC39
SurfaceG	ALL	glossy acid-etched CGSU66 CGSU67
SurfaceC	ALL	chrome glossy nickel CCS275 CCS287
Bulbs	ALL	bulb E27 - BIAX ECO 11W 6.000 hours bulb E27 - BIAX MINI TECH 11W bulb E27 - compatible bulb HALOPIN G9 max. 1x60W CEB328 CEB323 CEB476 CEB411
Cable colour	ALL	transparent CECL149
Material	ALL	plastics, PE, silicon glass CCM138 CCM139
Certification	ALL	CE EN 60598-1 EN 60598-2-1 CEC160 CEC567 CEC568

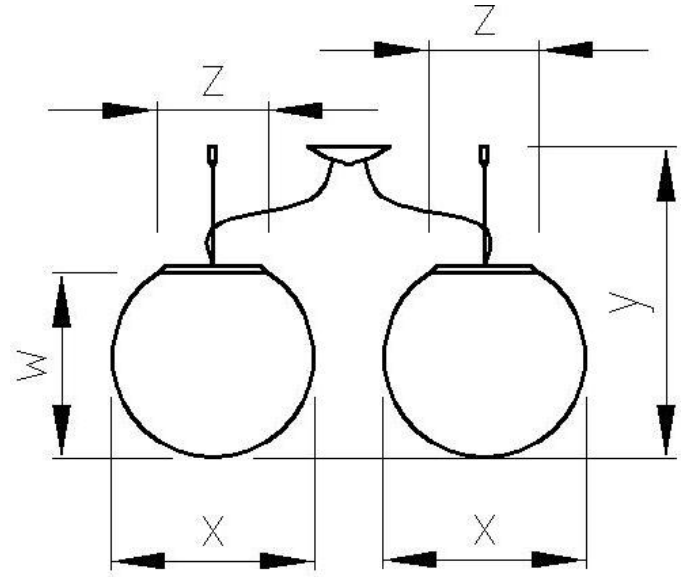

	x	y	w	z
PC229	150	1340	140	97

Identification

Name	ESFERA LUMÉ DUO
Type	suspension lamp
Collection	ESFERA
Line	Standard Line
Designed by	Alex Linger

BROKIS

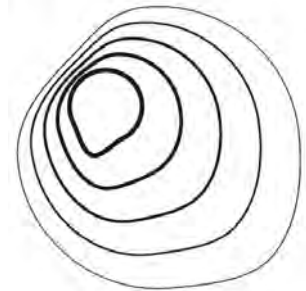

Description

Features

The Lamps from the ESFERA collection are made of triplex opal glass and are suitable for modern interior lighting in living rooms, halls, public places, etc. The suspension fitting can be delivered in four pendant variations. The construction of the hinge allows for the setting of the shade at any height.

Technology

Product Classification

Name	ESFERA	LUMÉ DUO
Colour	BAS	triplex opal CGC39
SurfaceG	ALL	glossy acid-etched CGSU66 CGSU67
SurfaceC	ALL	chrome glossy nickel CCS275 CCS287
Bulbs	ALL	bulb E27 - BIAX ECO 11W 6.000 hours bulb E27 - BIAX MINI TECH 11W bulb E27 - compatible bulb HALOPIN G9 max. 2x60W CEB328 CEB323 CEB476 CEB410
Cable colour	ALL	transparent CECL149
Material	ALL	plastics, PE, silicon glass CCM138 CCM139
Certification	ALL	CE EN 60598-1 EN 60598-2-1 CEC160 CEC567 CEC568

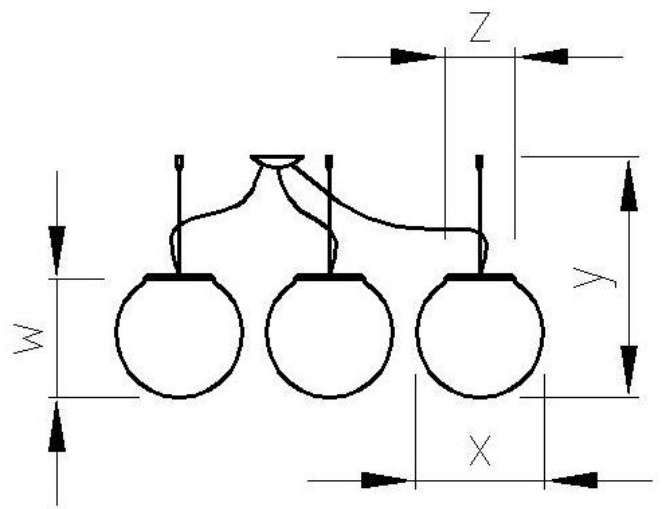

	X	Y	W	Z
PC230	150	1340	140	97

Identification

Name	ESFERA LUMÉ TRIO
Type	suspension lamp
Collection	ESFERA
Line	Standard Line
Designed by	Alex Linger

BROKIS

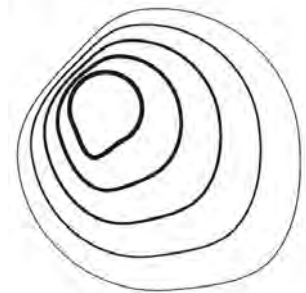

Description

Features

The Lamps from the ESFERA collection are made of triplex opal glass and are suitable for modern interior lighting in living rooms, halls, public places, etc. The suspension fitting can be delivered in four pendant variations. The construction of the hinge allows for the setting of the shade at any height.

Technology

Product Classification

Name	ESFERA	LUMÉ TRIO
Colour	BAS	triplex opal CGC39
SurfaceG	ALL	glossy acid-etched CGSU66 CGSU67
SurfaceC	ALL	chrome glossy nickel CCS275 CCS287
Bulbs	ALL	bulb E27 - BIAX ECO 11W 6.000 hours bulb E27 - BIAX MINI TECH 11W bulb E27 - compatible bulb HALOPIN G9 max. 3x60W CEB328 CEB323 CEB476 CEB409
Cable colour	ALL	transparent CECL149
Material	ALL	plastics, PE, silicon glass CCM138 CCM139
Certification	ALL	CE EN 60598-1 EN 60598-2-1 CEC160 CEC567 CEC568

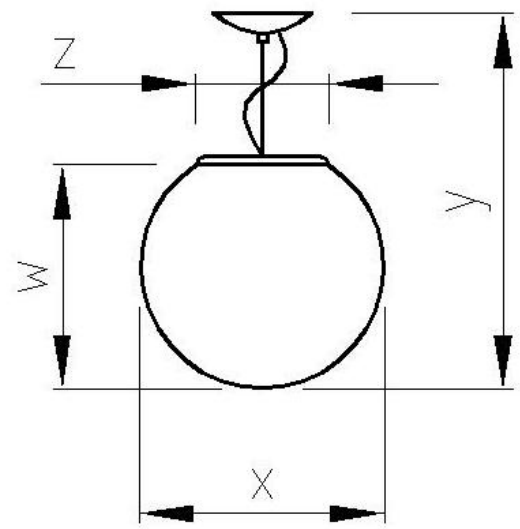
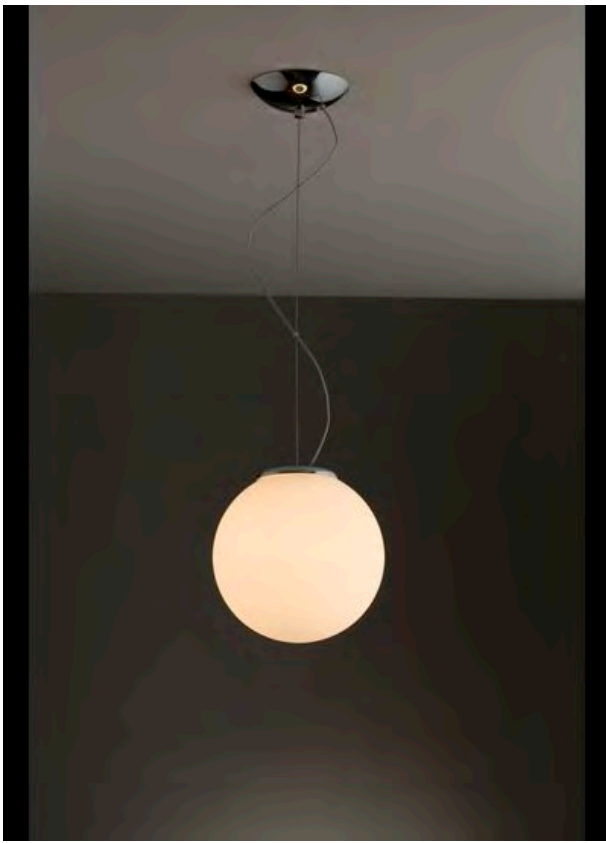

	X	Y	W	Z
PC231	200	1393	193	97

Identification

Name	ESFERA LUMÉ
Type	suspension lamp
Collection	ESFERA
Line	Standard Line
Designed by	Alex Linger

BROKIS

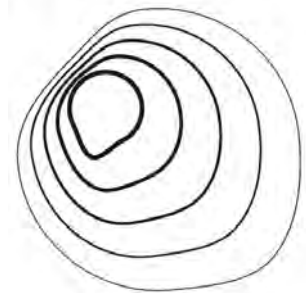

Description

Features

The Lamps from the ESFERA collection are made of triplex opal glass and are suitable for modern interior lighting in living rooms, halls, public places, etc. The suspension fitting can be delivered in four pendant variations. The construction of the hinge allows for the setting of the shade at any height.

Technology

Product Classification

Name	ESFERA	LUMÉ
Colour	BAS	triplex opal CGC39
SurfaceG	ALL	glossy acid-etched CGSU66 CGSU67
SurfaceC	ALL	chrome glossy nickel CCS275 CCS287
Bulbs	ALL	bulb E27 - BIAX ECO 15W 10.000 hours bulb E27 -BIAX MINI TECH 9W 15.000 hours bulb E27 - compatible bulb HALOPIN G9 max. 1x60W CEB329 CEB324 CEB476 CEB411
Cable colour	ALL	transparent CECL149
Material	ALL	plastics, PE, silicon glass CCM138 CCM139
Certification	ALL	CE EN 60598-1 EN 60598-2-1 CEC160 CEC567 CEC568

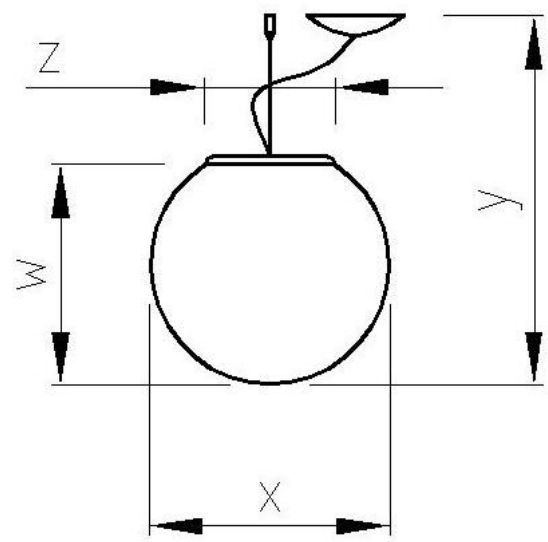

	X	Y	W	Z
PC232	200	1393	193	97

Identification

Name	ESFERA LUMÉ
Type	suspension lamp
Collection	ESFERA
Line	Standard Line
Designed by	Alex Linger

BROKIS

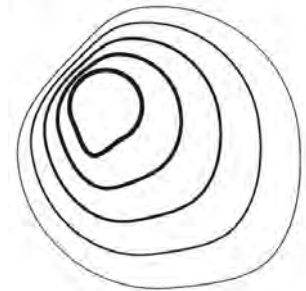

Description

Features

The Lamps from the ESFERA collection are made of triplex opal glass and are suitable for modern interior lighting in living rooms, halls, public places, etc. The suspension fitting can be delivered in four pendant variations. The construction of the hinge allows for the setting of the shade at any height.

Technology

Product Classification

Name	ESFERA	LUMÉ
Colour	BAS	triplex opal CGC39
SurfaceG	ALL	glossy acid-etched CGSU66 CGSU67
SurfaceC	ALL	chrome glossy nickel CCS275 CCS287
Bulbs	ALL	bulb E27 - BIAX ECO 15W 10.000 hours bulb E27 -BIAX MINI TECH 9W 15.000 hours bulb E27 - compatible bulb HALOPIN G9 max. 1x60W CEB329 CEB324 CEB476 CEB411
Cable colour	ALL	transparent CECL149
Material	ALL	plastics, PE, silicon glass CCM138 CCM139
Certification	ALL	CE EN 60598-1 EN 60598-2-1 CEC160 CEC567 CEC568

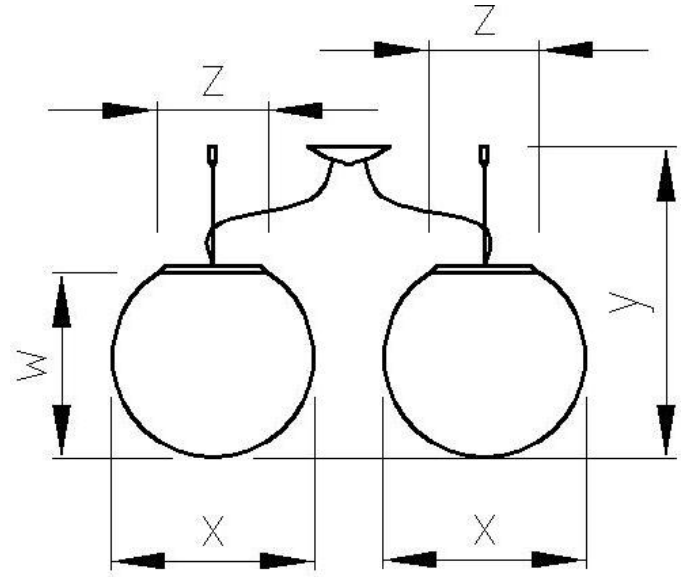

	X	Y	W	Z
PC233	200	1393	193	97

Identification

Name	ESFERA LUMÉ DUO
Type	suspension lamp
Collection	ESFERA
Line	Standard Line
Designed by	Alex Linger

BROKIS

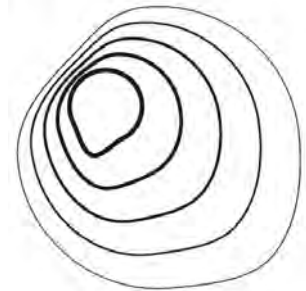

Description

Features

The Lamps from the ESFERA collection are made of triplex opal glass and are suitable for modern interior lighting in living rooms, halls, public places, etc. The suspension fitting can be delivered in four pendant variations. The construction of the hinge allows for the setting of the shade at any height.

Technology

Product Classification

Name	ESFERA	LUMÉ DUO
Colour	BAS	triplex opal CGC39
SurfaceG	ALL	glossy acid-etched CGSU66 CGSU67
SurfaceC	ALL	chrome glossy nickel CCS275 CCS287
Bulbs	ALL	bulb E27 - BIAX ECO 15W 10.000 hours bulb E27 -BIAX MINI TECH 9W 15.000 hours bulb E27 - compatible bulb HALOPIN G9 max. 2x60W CEB329 CEB324 CEB476 CEB410
Cable colour	ALL	transparent CECL149
Material	ALL	plastics, PE, silicon glass CCM138 CCM139
Certification	ALL	CE EN 60598-1 EN 60598-2-1 CEC160 CEC567 CEC568

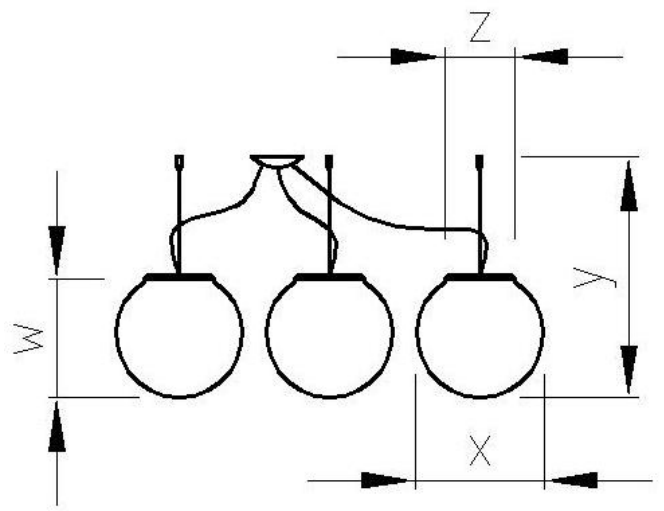

	X	Y	W	Z
PC234	200	1393	193	97

Identification

Name	ESFERA LUMÉ TRIO
Type	suspension lamp
Collection	ESFERA
Line	Standard Line
Designed by	Alex Linger

BROKIS

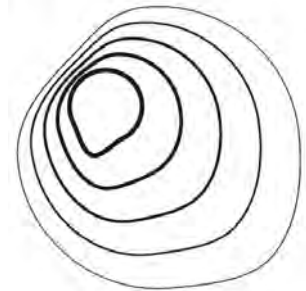

Description

Features

The Lamps from the ESFERA collection are made of triplex opal glass and are suitable for modern interior lighting in living rooms, halls, public places, etc. The suspension fitting can be delivered in four pendant variations. The construction of the hinge allows for the setting of the shade at any height.

Technology

Product Classification

Name	ESFERA	LUMÉ TRIO
Colour	BAS	triplex opal CGC39
SurfaceG	ALL	glossv acid-etched CGSU66 CGSU67
SurfaceC	ALL	chrome glossv nickel CCS275 CCS287
Bulbs	ALL	bulb E27 - BIAX ECO 15W 10.000 hours bulb E27 -BIAX MINI TECH 9W 15.000 hours bulb E27 - compatible bulb HALOPIN G9 max. 3x60W CEB329 CEB324 CEB476 CEB409
Cable colour	ALL	transparent CECL149
Material	ALL	plastics, PE, silicon glass CCM138 CCM139
Certification	ALL	CE EN 60598-1 EN 60598-2-1 CEC160 CEC567 CEC568

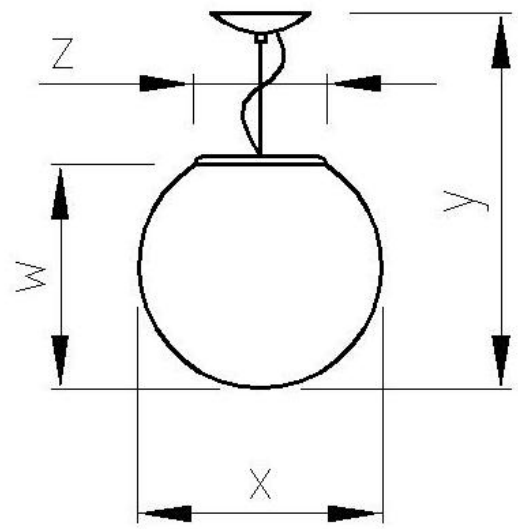

	X	Y	W	Z
PC235	250	1430	230	145

Identification

Name	ESFERA LUMÉ
Type	suspension lamp
Collection	ESFERA
Line	Standard Line
Designed by	Alex Linger

BROKIS

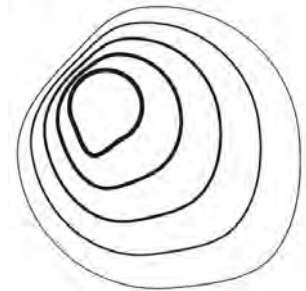

Description

Features

The Lamps from the ESFERA collection are made of triplex opal glass and are suitable for modern interior lighting in living rooms, halls, public places, etc. The suspension fitting can be delivered in four pendant variations. The construction of the hinge allows for the setting of the shade at any height.

Technology

Product Classification

Name	ESFERA	LUMÉ
Colour	BAS	triplex opal CGC39
SurfaceG	ALL	glossv acid-etched CGSU66 CGSU67
Ornaments	STA	optic - straight CGO464
SurfaceC	ALL	chrome glossv nickel CCS275 CCS287
Bulbs	ALL	bulb E27 - BIAX ECO 20W 10.000 hours bulb E27 - BIAX MINI TECH. 20W 15.000 hours bulb E27 - compatible bulb HALOPIN G9 max. 1x60W CEB330 CEB325 CEB476 CEB411
Cable colour	ALL	transparent CECL149
Material	ALL	plastics. PE. silicon glass CCM138 CCM139
Certification	ALL	CE EN 60598-1 EN 60598-2-1 CEC160 CEC567 CEC568

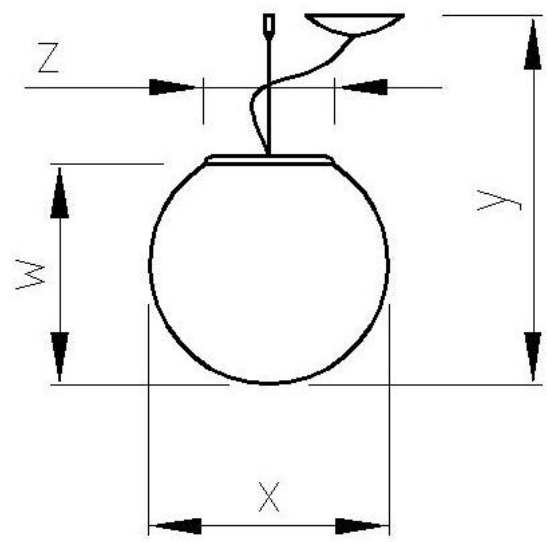

	X	Y	W	Z
PC236	250	1430	230	145

Identification

Name	ESFERA LUMÉ
Type	suspension lamp
Collection	ESFERA
Line	Standard Line
Designed by	Alex Linger

BROKIS

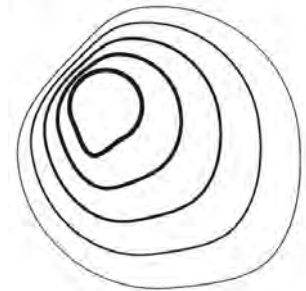

Description

Features

The Lamps from the ESFERA collection are made of triplex opal glass and are suitable for modern interior lighting in living rooms, halls, public places, etc. The suspension fitting can be delivered in four pendant variations. The construction of the hinge allows for the setting of the shade at any height.

Technology

Product Classification

Name	ESFERA	LUMÉ
Colour	BAS	triplex opal CGC39
SurfaceG	ALL	glossv acid-etched CGSU66 CGSU67
Ornaments	STA	optic - straight CGO464
SurfaceC	ALL	chrome glossv nickel CCS275 CCS287
Bulbs	ALL	bulb E27 - BIAX ECO 20W 10.000 hours bulb E27 - BIAX MINI TECH. 20W 15.000 hours bulb E27 - compatible bulb HALOPIN G9 max. 1x60W CEB330 CEB325 CEB476 CEB411
Cable colour	ALL	transparent CECL149
Material	ALL	plastics. PE. silicon glass CCM138 CCM139
Certification	ALL	CE EN 60598-1 EN 60598-2-1 CEC160 CEC567 CEC568

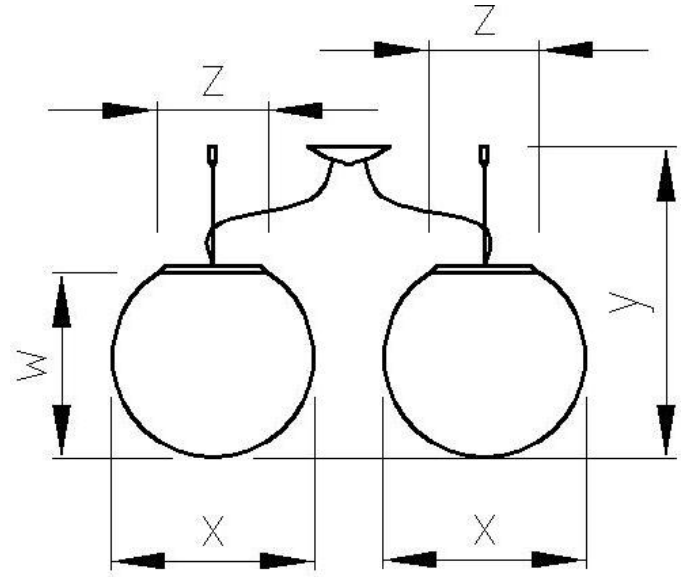

	x	y	w	z
PC237	250	1430	230	145

Identification

Name	ESFERA LUMÉ DUO
Type	suspension lamp
Collection	ESFERA
Line	Standard Line
Designed by	Alex Linger

BROKIS

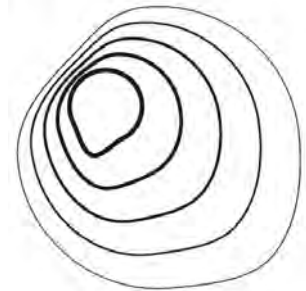

Description

Features

The Lamps from the ESFERA collection are made of triplex opal glass and are suitable for modern interior lighting in living rooms, halls, public places, etc. The suspension fitting can be delivered in four pendant variations. The construction of the hinge allows for the setting of the shade at any height.

Technology

Product Classification

Name	ESFERA	LUMÉ DUO
Colour	BAS	triplex opal CGC39
SurfaceG	ALL	glossv acid-etched CGSU66 CGSU67
Ornaments	STA	optic - straight CGO464
SurfaceC	ALL	chrome glossv nickel CCS275 CCS287
Bulbs	ALL	bulb E27 - BIAX ECO 20W 10.000 hours bulb E27 - BIAX MINI TECH. 20W 15.000 hours bulb E27 - compatible bulb HALOPIN G9 max. 2x60W CEB330 CEB325 CEB476 CEB410
Cable colour	ALL	transparent CECL149
Material	ALL	plastics. PE. silicon glass CCM138 CCM139
Certification	ALL	CE EN 60598-1 EN 60598-2-1 CEC160 CEC567 CEC568

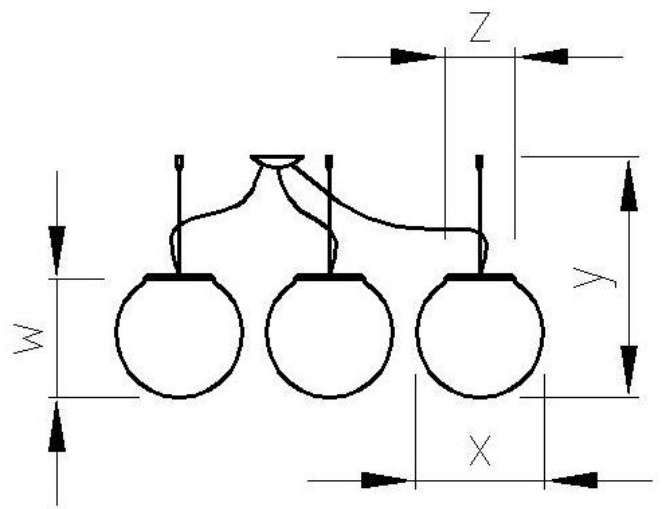
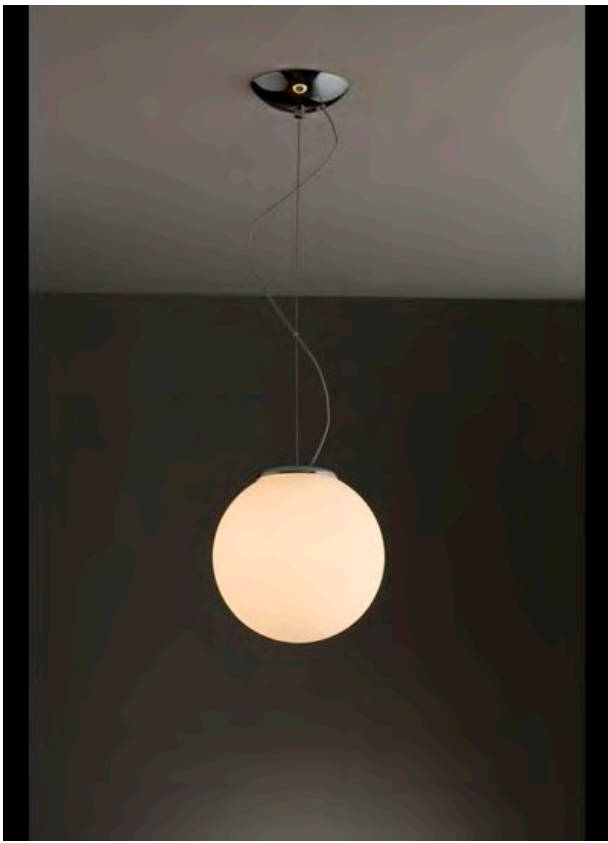

	X	y	w	Z
PC238	250	1430	230	145

Identification

Name	ESFERA LUMÉ TRIO
Type	suspension lamp
Collection	ESFERA
Line	Standard Line
Designed by	Alex Linger

BROKIS

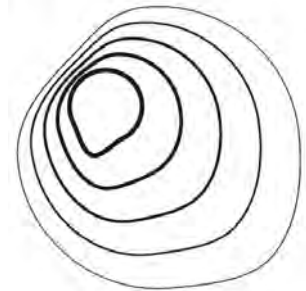

Description

Features

The Lamps from the ESFERA collection are made of triplex opal glass and are suitable for modern interior lighting in living rooms, halls, public places, etc. The suspension fitting can be delivered in four pendant variations. The construction of the hinge allows for the setting of the shade at any height.

Technology

Product Classification

Name	ESFERA	LUMÉ TRIO
Colour	BAS	triplex opal CGC39
SurfaceG	ALL	glossv acid-etched CGSU66 CGSU67
Ornaments	STA	optic - straight CGO464
SurfaceC	ALL	chrome glossv nickel CCS275 CCS287
Bulbs	ALL	bulb E27 - BIAX ECO 20W 10.000 hours bulb E27 - BIAX MINI TECH. 20W 15.000 hours bulb E27 - compatible bulb HALOPIN G9 max. 3x60W CEB330 CEB325 CEB476 CEB409
Cable colour	ALL	transparent CECL149
Material	ALL	plastics. PE. silicon glass CCM138 CCM139
Certification	ALL	CE EN 60598-1 EN 60598-2-1 CEC160 CEC567 CEC568

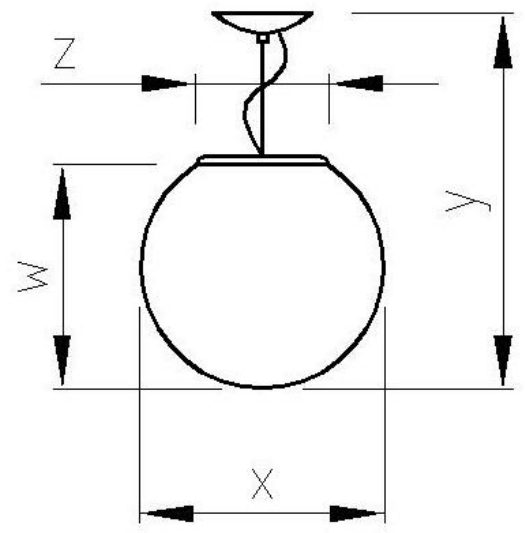

	X	Y	W	Z
PC239	300	1484	284	145

Identification

Name	ESFERA LUMÉ
Type	suspension lamp
Collection	ESFERA
Line	Standard Line
Designed by	Alex Linger

BROKIS

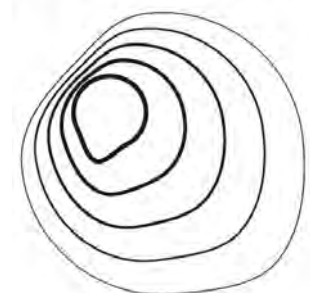

Description

Features

The Lamps from the ESFERA collection are made of triplex opal glass and are suitable for modern interior lighting in living rooms, halls, public places, etc. The suspension fitting can be delivered in four pendant variations. The construction of the hinge allows for the setting of the shade at any height.

Technology

Product Classification

Name	ESFERA	LUMÉ
Colour	BAS	triplex opal CGC39
SurfaceG	ALL	glossv acid-etched CGSU66 CGSU67
Ornaments	STA	optic - straight CGO464
SurfaceC	ALL	chrome glossv nickel CCS275 CCS287
Bulbs	ALL	bulb E27 - BIAX ECO 20W 10.000 hours bulb E27 - BIAX MINI TECH. 20W 15.000 hours bulb E27 - compatible bulb HALOPIN G9 max. 1x60W CEB330 CEB325 CEB476 CEB411
Cable colour	ALL	transparent CECL149
Material	ALL	plastics. PE. silicon glass CCM138 CCM139
Certification	ALL	CE EN 60598-1 EN 60598-2-1 CEC160 CEC567 CEC568

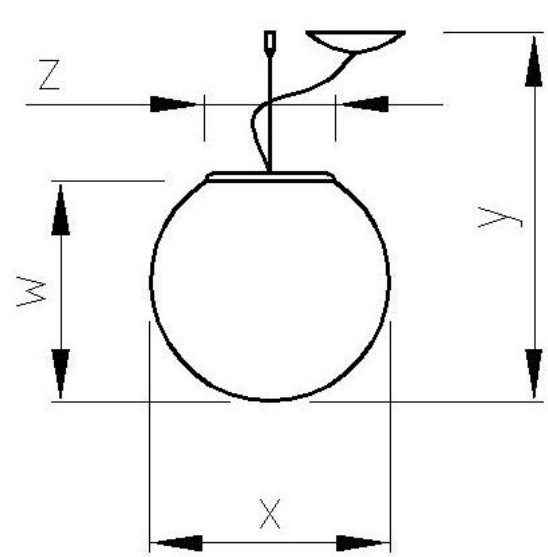

	X	Y	W	Z
PC240	300	1484	284	145

Identification

Name	ESFERA LUMÉ
Type	suspension lamp
Collection	ESFERA
Line	Standard Line
Designed by	Alex Linger

BROKIS

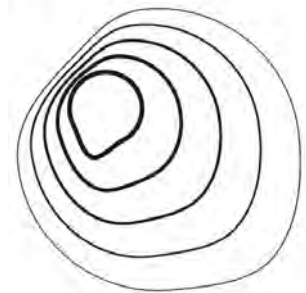

Description

Features

The Lamps from the ESFERA collection are made of triplex opal glass and are suitable for modern interior lighting in living rooms, halls, public places, etc. The suspension fitting can be delivered in four pendant variations. The construction of the hinge allows for the setting of the shade at any height.

Technology

Product Classification

Name	ESFERA	LUMÉ
Colour	BAS	triplex opal CGC39
SurfaceG	ALL	glossv acid-etched CGSU66 CGSU67
Ornaments	STA	optic - straight CGO464
SurfaceC	ALL	chrome glossv nickel CCS275 CCS287
Bulbs	ALL	bulb E27 - BIAX ECO 20W 10.000 hours bulb E27 - BIAX MINI TECH. 20W 15.000 hours bulb E27 - compatible bulb HALOPIN G9 max. 1x60W CEB330 CEB325 CEB476 CEB411
Cable colour	ALL	transparent CECL149
Material	ALL	plastics. PE. silicon glass CCM138 CCM139
Certification	ALL	CE EN 60598-1 EN 60598-2-1 CEC160 CEC567 CEC568

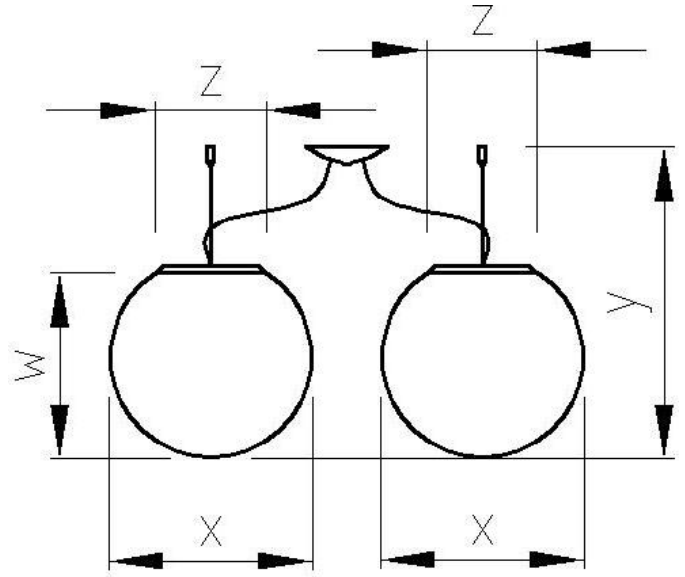

	x	y	w	z
PC241	300	1484	284	145

Identification

Name	ESFERA LUMÉ DUO
Type	suspension lamp
Collection	ESFERA
Line	Standard Line
Designed by	Alex Linger

BROKIS

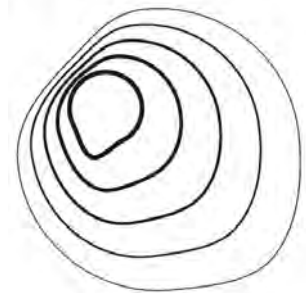

Description

Features

The Lamps from the ESFERA collection are made of triplex opal glass and are suitable for modern interior lighting in living rooms, halls, public places, etc. The suspension fitting can be delivered in four pendant variations. The construction of the hinge allows for the setting of the shade at any height.

Technology

Product Classification

Name	ESFERA	LUMÉ DUO
Colour	BAS	triplex opal CGC39
SurfaceG	ALL	glossv acid-etched CGSU66 CGSU67
Ornaments	STA	optic - straight CGO464
SurfaceC	ALL	chrome glossv nickel CCS275 CCS287
Bulbs	ALL	bulb E27 - BIAX ECO 20W 10.000 hours bulb E27 - BIAX MINI TECH. 20W 15.000 hours bulb E27 - compatible bulb HALOPIN G9 max. 2x60W CEB330 CEB325 CEB476 CEB410
Cable colour	ALL	transparent CECL149
Material	ALL	plastics. PE. silicon glass CCM138 CCM139
Certification	ALL	CE EN 60598-1 EN 60598-2-1 CEC160 CEC567 CEC568

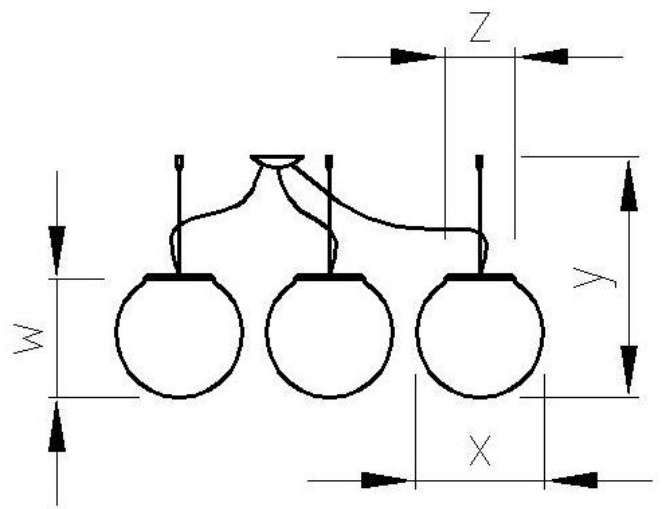

	X	Y	W	Z
PC242	300	1484	284	145

Identification

Name	ESFERA LUMÉ TRIO
Type	suspension lamp
Collection	ESFERA
Line	Standard Line
Designed by	Alex Linger

BROKIS

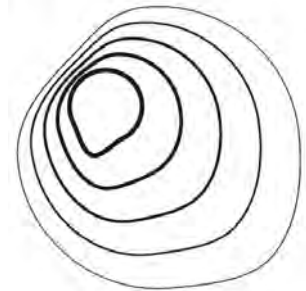

Description

Features

The Lamps from the ESFERA collection are made of triplex opal glass and are suitable for modern interior lighting in living rooms, halls, public places, etc. The suspension fitting can be delivered in four pendant variations. The construction of the hinge allows for the setting of the shade at any height.

Technology

Product Classification

Name	ESFERA	LUMÉ TRIO
Colour	BAS	triplex opal CGC39
SurfaceG	ALL	glossv acid-etched CGSU66 CGSU67
Ornaments	STA	optic - straight CGO464
SurfaceC	ALL	chrome glossv nickel CCS275 CCS287
Bulbs	ALL	bulb E27 - BIAX ECO 20W 10.000 hours bulb E27 - BIAX MINI TECH. 20W 15.000 hours bulb E27 - compatible bulb HALOPIN G9 max. 3x60W CEB330 CEB325 CEB476 CEB409
Cable colour	ALL	transparent CECL149
Material	ALL	plastics. PE. silicon glass CCM138 CCM139
Certification	ALL	CE EN 60598-1 EN 60598-2-1 CEC160 CEC567 CEC568

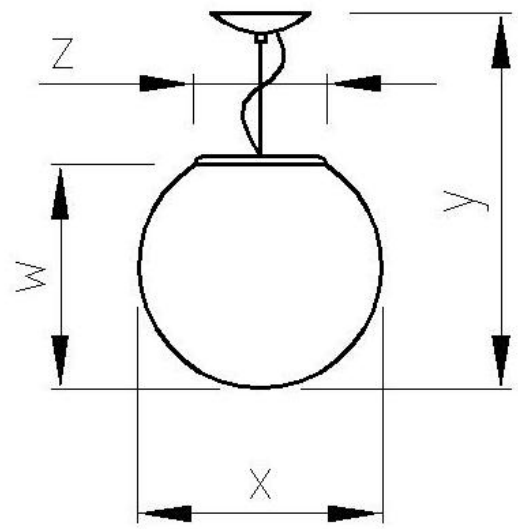

	X	Y	W	Z
PC243	350	1535	335	145

Identification

Name	ESFERA LUMÉ
Type	suspension lamp
Collection	ESFERA
Line	Standard Line
Designed by	Alex Linger

BROKIS

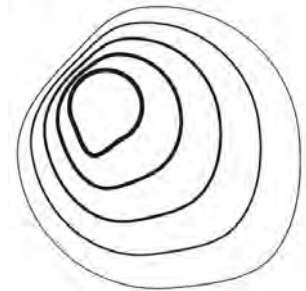

Description

Features

The Lamps from the ESFERA collection are made of triplex opal glass and are suitable for modern interior lighting in living rooms, halls, public places, etc. The suspension fitting can be delivered in four pendant variations. The construction of the hinge allows for the setting of the shade at any height.

Technology

Product Classification

Name	ESFERA	LUMÉ
Colour	BAS	triplex opal CGC39
SurfaceG	ALL	glossv acid-etched CGSU66 CGSU67
Ornaments	STA	optic - straight CGO464
SurfaceC	ALL	chrome glossv nickel CCS275 CCS287
Bulbs	ALL	bulb E27 - BIAX ECO 20W 10.000 hours bulb E27 - BIAX MINI TECH. 20W 15.000 hours bulb E27 - compatible bulb HALOPIN G9 max. 1x60W CEB330 CEB325 CEB476 CEB411
Cable colour	ALL	transparent CECL149
Material	ALL	plastics. PE. silicon glass CCM138 CCM139
Certification	ALL	CE EN 60598-1 EN 60598-2-1 CEC160 CEC567 CEC568

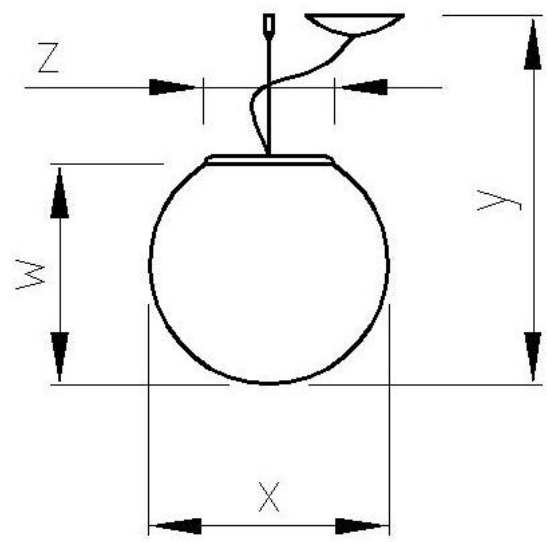

	X	Y	W	Z
PC244	350	1535	335	145

Identification

Name	ESFERA LUMÉ
Type	suspension lamp
Collection	ESFERA
Line	Standard Line
Designed by	Alex Linger

BROKIS

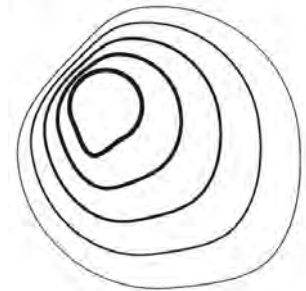

Description

Features

The Lamps from the ESFERA collection are made of triplex opal glass and are suitable for modern interior lighting in living rooms, halls, public places, etc. The suspension fitting can be delivered in four pendant variations. The construction of the hinge allows for the setting of the shade at any height.

Technology

Product Classification

Name	ESFERA	LUMÉ
Colour	BAS	triplex opal CGC39
SurfaceG	ALL	glossv acid-etched CGSU66 CGSU67
Ornaments	STA	optic - straight CGO464
SurfaceC	ALL	chrome glossv nickel CCS275 CCS287
Bulbs	ALL	bulb E27 - BIAX ECO 20W 10.000 hours bulb E27 - BIAX MINI TECH. 20W 15.000 hours bulb E27 - compatible bulb HALOPIN G9 max. 1x60W CEB330 CEB325 CEB476 CEB411
Cable colour	ALL	transparent CECL149
Material	ALL	plastics. PE. silicon glass CCM138 CCM139
Certification	ALL	CE EN 60598-1 EN 60598-2-1 CEC160 CEC567 CEC568

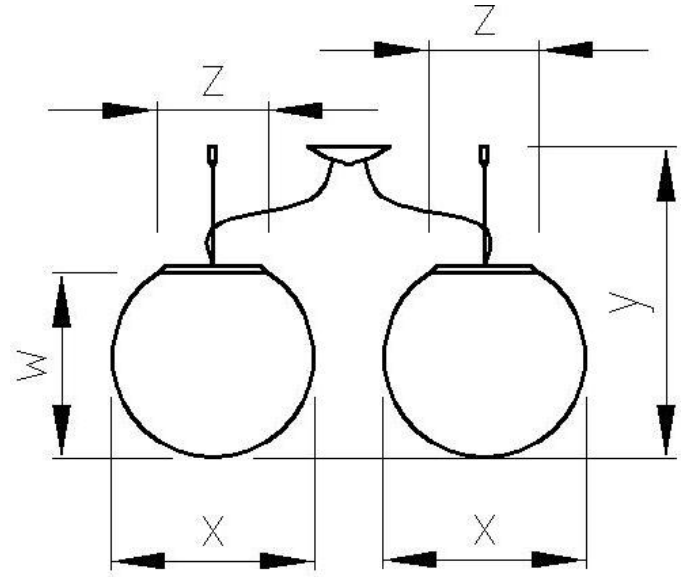

	x	y	w	z
PC245	350	1535	335	145

Identification

Name	ESFERA LUMÉ DUO
Type	suspension lamp
Collection	ESFERA
Line	Standard Line
Designed by	Alex Linger

BROKIS

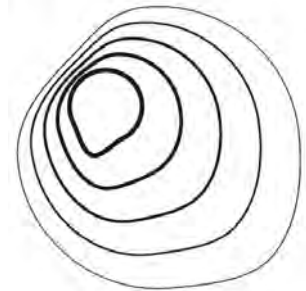

Description

Features

The Lamps from the ESFERA collection are made of triplex opal glass and are suitable for modern interior lighting in living rooms, halls, public places, etc. The suspension fitting can be delivered in four pendant variations. The construction of the hinge allows for the setting of the shade at any height.

Technology

Product Classification

Name	ESFERA	LUMÉ DUO
Colour	BAS	triplex opal CGC39
SurfaceG	ALL	glossv acid-etched CGSU66 CGSU67
Ornaments	STA	optic - straight CGO464
SurfaceC	ALL	chrome glossv nickel CCS275 CCS287
Bulbs	ALL	bulb E27 - BIAX ECO 20W 10.000 hours bulb E27 - BIAX MINI TECH. 20W 15.000 hours bulb E27 - compatible bulb HALOPIN G9 max. 2x60W CEB330 CEB325 CEB476 CEB410
Cable colour	ALL	transparent CECL149
Material	ALL	plastics. PE. silicon glass CCM138 CCM139
Certification	ALL	CE EN 60598-1 EN 60598-2-1 CEC160 CEC567 CEC568

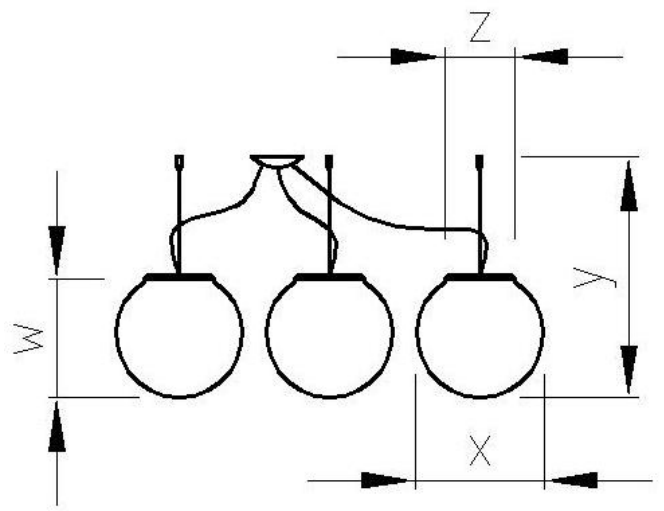

	X	Y	W	Z
PC246	350	1535	335	145

Identification

Name	ESFERA LUMÉ TRIO
Type	suspension lamp
Collection	ESFERA
Line	Standard Line
Designed by	Alex Linger

BROKIS

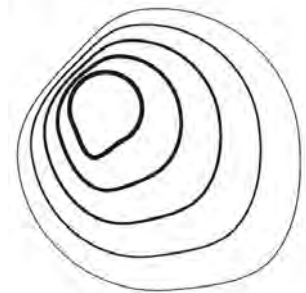

Description

Features

The Lamps from the ESFERA collection are made of triplex opal glass and are suitable for modern interior lighting in living rooms, halls, public places, etc. The suspension fitting can be delivered in four pendant variations. The construction of the hinge allows for the setting of the shade at any height.

Technology

Product Classification

Name	ESFERA	LUMÉ TRIO
Colour	BAS	triplex opal CGC39
SurfaceG	ALL	glossv acid-etched CGSU66 CGSU67
Ornaments	STA	optic - straight CGO464
SurfaceC	ALL	chrome glossv nickel CCS275 CCS287
Bulbs	ALL	bulb E27 - BIAX ECO 20W 10.000 hours bulb E27 - BIAX MINI TECH. 20W 15.000 hours bulb E27 - compatible bulb HALOPIN G9 max. 3x60W CEB330 CEB325 CEB476 CEB409
Cable colour	ALL	transparent CECL149
Material	ALL	plastics. PE. silicon glass CCM138 CCM139
Certification	ALL	CE EN 60598-1 EN 60598-2-1 CEC160 CEC567 CEC568

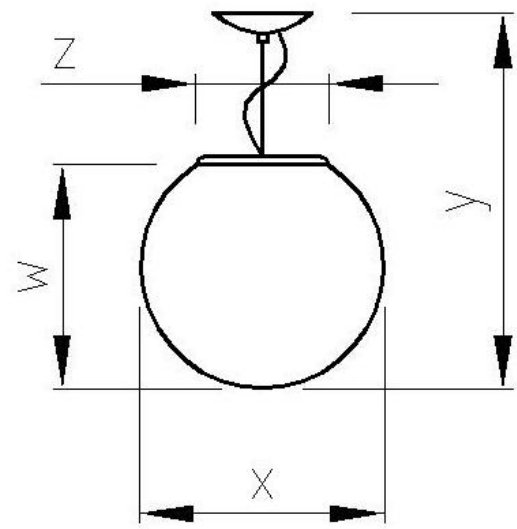

	X	Y	W	Z
PC247	400	1590	390	145

Identification

Name	ESFERA LUMÉ
Type	suspension lamp
Collection	ESFERA
Line	Standard Line
Designed by	Alex Linger

BROKIS

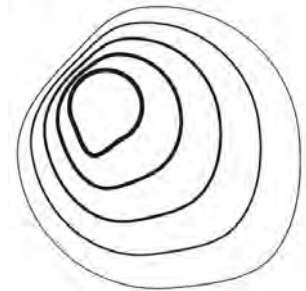

Description

Features

The Lamps from the ESFERA collection are made of triplex opal glass and are suitable for modern interior lighting in living rooms, halls, public places, etc. The suspension fitting can be delivered in four pendant variations. The construction of the hinge allows for the setting of the shade at any height.

Technology

Product Classification

Name	ESFERA	LUMÉ
Colour	BAS	triplex opal CGC39
SurfaceG	ALL	glossv acid-etched CGSU66 CGSU67
Ornaments	STA	optic - straight CGO464
SurfaceC	ALL	chrome glossv nickel CCS275 CCS287
Bulbs	ALL	E27 - enerav savina 23W bulb E27 - compatible bulb HALOPIN G9 max. 1x2G9 CEB388 CEB476 CEB412
Cable colour	ALL	transparent CECL149
Material	ALL	plastics. PE. silicon glass CCM138 CCM139
Certification	ALL	CE EN 60598-1 EN 60598-2-1 CEC160 CEC567 CEC568

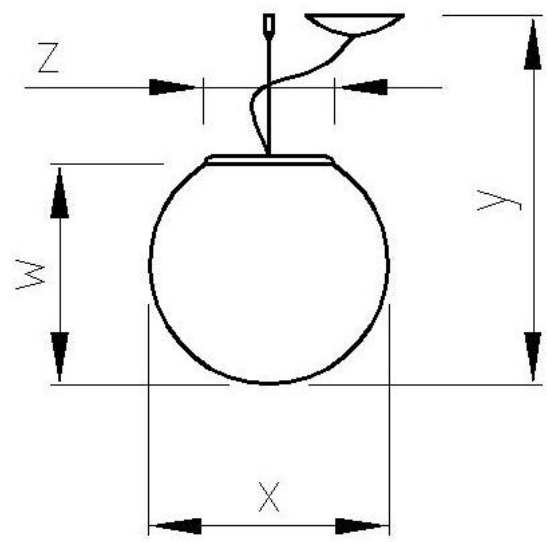

	X	Y	W	Z
PC248	400	1590	390	145

Identification

Name	ESFERA LUMÉ
Type	suspension lamp
Collection	ESFERA
Line	Standard Line
Designed by	Alex Linger

BROKIS

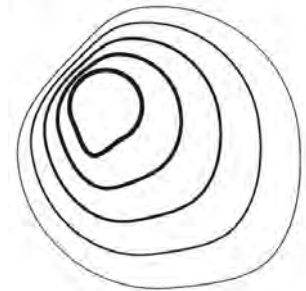

Description

Features

The Lamps from the ESFERA collection are made of triplex opal glass and are suitable for modern interior lighting in living rooms, halls, public places, etc. The suspension fitting can be delivered in four pendant variations. The construction of the hinge allows for the setting of the shade at any height.

Technology

Product Classification

Name	ESFERA	LUMÉ
Colour	BAS	triplex opal CGC39
SurfaceG	ALL	glossv acid-etched CGSU66 CGSU67
Ornaments	STA	optic - straight CGO464
SurfaceC	ALL	chrome glossv nickel CCS275 CCS287
Bulbs	ALL	E27 - enerav savina 23W bulb E27 - compatible bulb HALOPIN G9 max. 1x2G9 CEB388 CEB476 CEB412
Cable colour	ALL	transparent CECL149
Material	ALL	plastics. PE. silicon glass CCM138 CCM139
Certification	ALL	CE EN 60598-1 EN 60598-2-1 CEC160 CEC567 CEC568

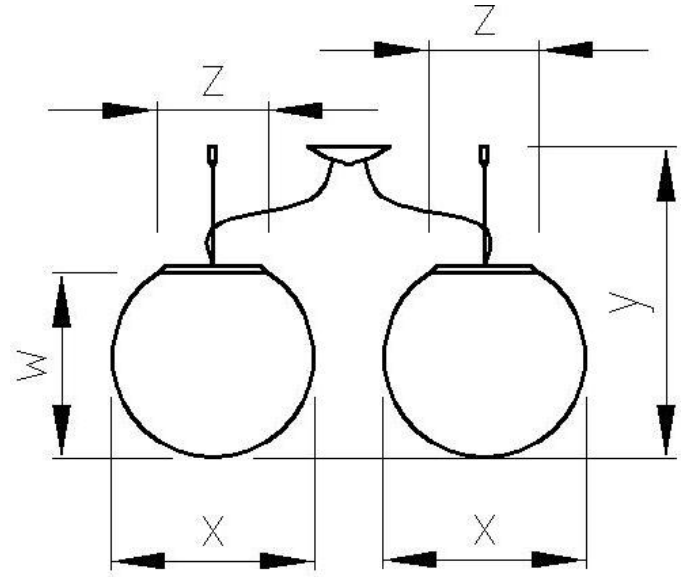

	X	Y	W	Z
PC249	400	1590	390	145

Identification

Name	ESFERA LUMÉ DUO
Type	suspension lamp
Collection	ESFERA
Line	Standard Line
Designed by	Alex Linger

BROKIS

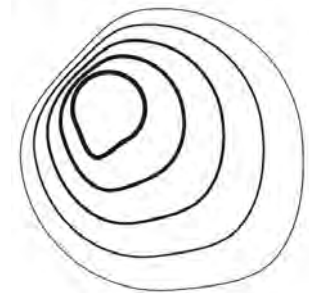

Description

Features

The Lamps from the ESFERA collection are made of triplex opal glass and are suitable for modern interior lighting in living rooms, halls, public places, etc. The suspension fitting can be delivered in four pendant variations. The construction of the hinge allows for the setting of the shade at any height.

Technology

Product Classification

Name	ESFERA	LUMÉ DUO
Colour	BAS	triplex opal CGC39
SurfaceG	ALL	glossv acid-etched CGSU66 CGSU67
Ornaments	STA	optic - straight CGO464
SurfaceC	ALL	chrome glossv nickel CCS275 CCS287
Bulbs	ALL	E27 - enerav savina 23W bulb E27 - compatible bulb HALOPIN G9 max. 2x2G9 CEB388 CEB476 CEB413
Cable colour	ALL	transparent CECL149
Material	ALL	plastics. PE. silicon glass CCM138 CCM139
Certification	ALL	CE EN 60598-1 EN 60598-2-1 CEC160 CEC567 CEC568

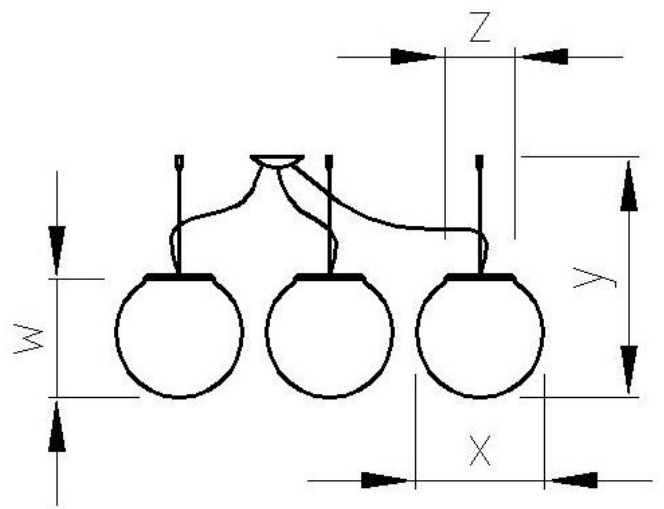

	X	Y	W	Z
PC250	400	1590	390	145

Identification

Name	ESFERA LUMÉ TRIO
Type	suspension lamp
Collection	ESFERA
Line	Standard Line
Designed by	Alex Linger

BROKIS

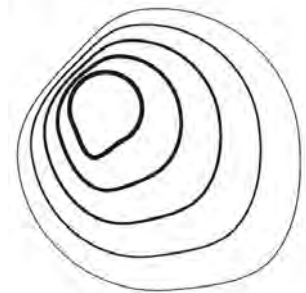

Description

Features

The Lamps from the ESFERA collection are made of triplex opal glass and are suitable for modern interior lighting in living rooms, halls, public places, etc. The suspension fitting can be delivered in four pendant variations. The construction of the hinge allows for the setting of the shade at any height.

Technology

Product Classification

Name	ESFERA	LUMÉ TRIO
Colour	BAS	triplex opal CGC39
SurfaceG	ALL	glossv acid-etched CGSU66 CGSU67
Ornaments	STA	optic - straight CGO464
SurfaceC	ALL	chrome glossv nickel CCS275 CCS287
Bulbs	ALL	E27 - enerav savina 23W bulb E27 - compatible bulb HALOPIN G9 max. 3x2G9 CEB388 CEB476 CEB414
Cable colour	ALL	transparent CECL149
Material	ALL	plastics. PE. silicon glass CCM138 CCM139
Certification	ALL	CE EN 60598-1 EN 60598-2-1 CEC160 CEC567 CEC568

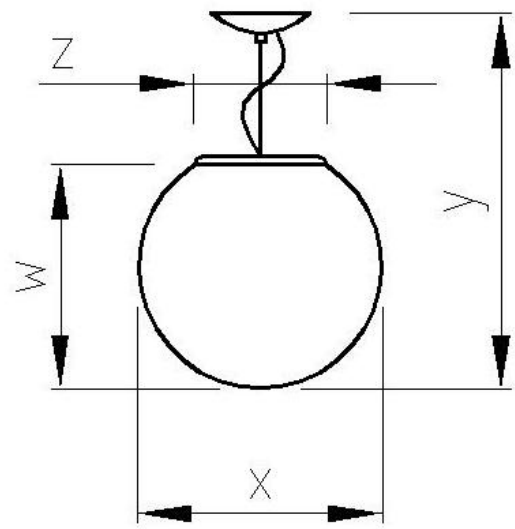

	X	Y	W	Z
PC251	420	1610	410	145

Identification

Name	ESFERA LUMÉ
Type	suspension lamp
Collection	ESFERA
Line	Standard Line
Designed by	Alex Linger

BROKIS

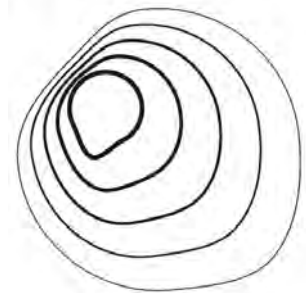

Description

Features

The Lamps from the ESFERA collection are made of triplex opal glass and are suitable for modern interior lighting in living rooms, halls, public places, etc. The suspension fitting can be delivered in four pendant variations. The construction of the hinge allows for the setting of the shade at any height.

Technology

Product Classification

Name	ESFERA	LUMÉ
Colour	BAS	triplex opal CGC39
SurfaceG	ALL	glossv acid-etched CGSU66 CGSU67
Ornaments	STA	optic - straight CGO464
SurfaceC	ALL	chrome glossv nickel CCS275 CCS287
Bulbs	ALL	E27 - enerav savina 23W bulb E27 - compatible bulb HALOPIN G9 max. 1x2G9 CEB388 CEB476 CEB412
Cable colour	ALL	transparent CECL149
Material	ALL	plastics. PE. silicon glass CCM138 CCM139
Certification	ALL	CE EN 60598-1 EN 60598-2-1 CEC160 CEC567 CEC568

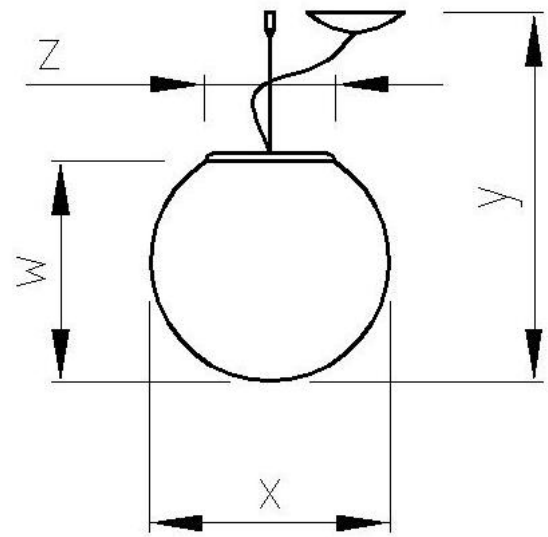

	X	Y	W	Z
PC252	420	1610	410	145

Identification

Name	ESFERA LUMÉ
Type	suspension lamp
Collection	ESFERA
Line	Standard Line
Designed by	Alex Linger

BROKIS

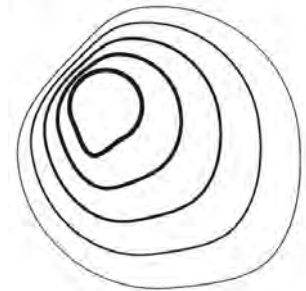

Description

Features

The Lamps from the ESFERA collection are made of triplex opal glass and are suitable for modern interior lighting in living rooms, halls, public places, etc. The suspension fitting can be delivered in four pendant variations. The construction of the hinge allows for the setting of the shade at any height.

Technology

Product Classification

Name	ESFERA	LUMÉ
Colour	BAS	triplex opal CGC39
SurfaceG	ALL	glossv acid-etched CGSU66 CGSU67
Ornaments	STA	optic - straight CGO464
SurfaceC	ALL	chrome glossv nickel CCS275 CCS287
Bulbs	ALL	E27 - enerav savina 23W bulb E27 - compatible bulb HALOPIN G9 max. 1x2G9 CEB388 CEB476 CEB412
Cable colour	ALL	transparent CECL149
Material	ALL	plastics. PE. silicon glass CCM138 CCM139
Certification	ALL	CE EN 60598-1 EN 60598-2-1 CEC160 CEC567 CEC568

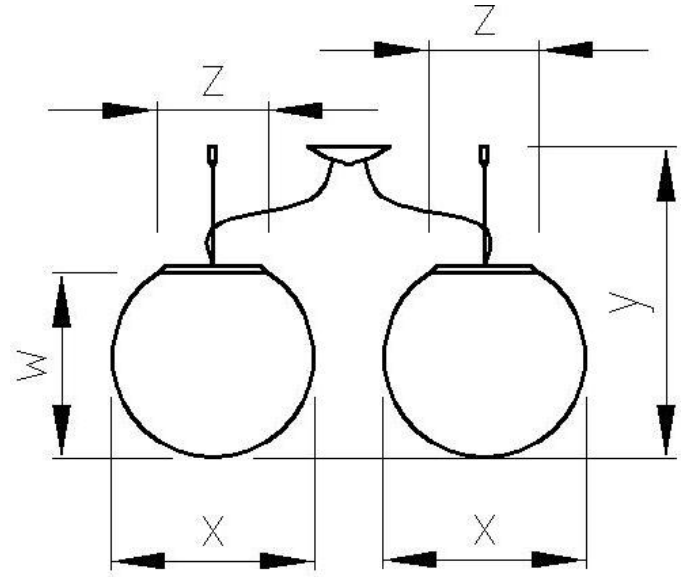

	x	y	w	z
PC253	420	1610	410	145

Identification

Name	ESFERA LUMÉ DUO
Type	suspension lamp
Collection	ESFERA
Line	Standard Line
Designed by	Alex Linger

BROKIS

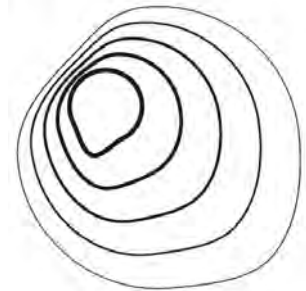

Description

Features

The Lamps from the ESFERA collection are made of triplex opal glass and are suitable for modern interior lighting in living rooms, halls, public places, etc. The suspension fitting can be delivered in four pendant variations. The construction of the hinge allows for the setting of the shade at any height.

Technology

Product Classification

Name	ESFERA	LUMÉ DUO
Colour	BAS	triplex opal CGC39
SurfaceG	ALL	glossy acid-etched CGSU66 CGSU67
Ornaments	STA	optic - straight CGO464
	ALL	chrome glossy nickel CCS275 CCS287
Bulbs	ALL	E27 - enerav savina 23W bulb E27 - compatible bulb HALOPIN G9 max. 2x2G9 CEB388 CEB476 CEB413
Cable colour	ALL	transparent CECL149
Material	ALL	plastics, PE, silicon glass CCM138 CCM139
Certification	ALL	EN 60598-1 EN 60598-2-1 CEC567 CEC568

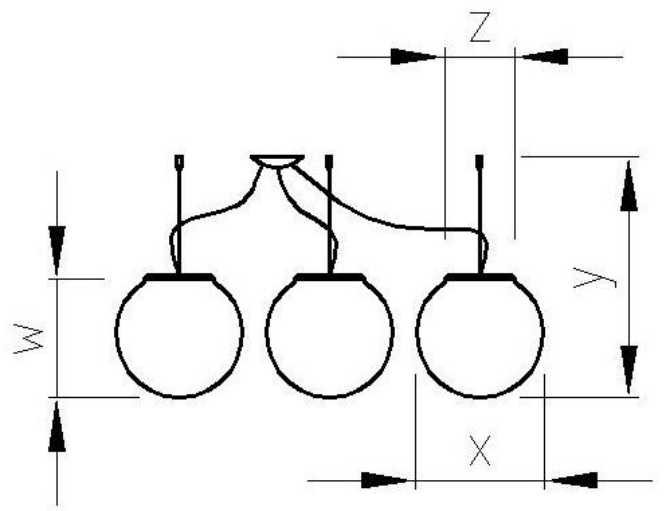

	X	Y	W	Z
PC254	420	1610	410	145

Identification

Name	ESFERA LUMÉ TRIO
Type	suspension lamp
Collection	ESFERA
Line	Standard Line
Designed by	Alex Linger

BROKIS

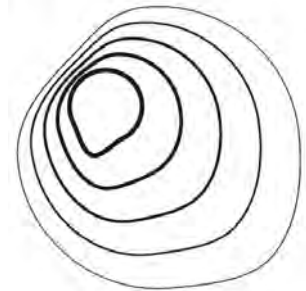

Description

Features

The Lamps from the ESFERA collection are made of triplex opal glass and are suitable for modern interior lighting in living rooms, halls, public places, etc. The suspension fitting can be delivered in four pendant variations. The construction of the hinge allows for the setting of the shade at any height.

Technology

Product Classification

Name	ESFERA	LUMÉ TRIO
Colour	BAS	triplex opal CGC39
SurfaceG	ALL	glossv acid-etched CGSU66 CGSU67
Ornaments	STA	optic - straight CGO464
SurfaceC	ALL	chrome glossv nickel CCS275 CCS287
Bulbs	ALL	E27 - enerav savina 23W bulb E27 - compatible bulb HALOPIN G9 max. 3x2G9 CEB388 CEB476 CEB414
Cable colour	ALL	transparent CECL149
Material	ALL	plastics. PE. silicon glass CCM138 CCM139
Certification	ALL	CE EN 60598-1 EN 60598-2-1 CEC160 CEC567 CEC568

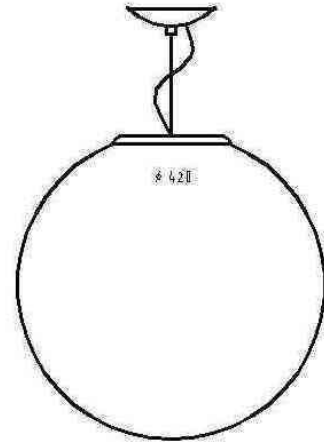

	X	Y	W	Z
PC585	505	1690	490	190

Identification

Name	ESFERA LUMÉ
Type	suspension lamp
Collection	ESFERA
Line	Standard Line
Designed by	Alex Linger

BROKIS

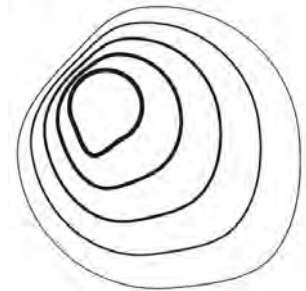

Description

Features

The Lamps from the ESFERA collection are made of triplex opal glass and are suitable for modern interior lighting in living rooms, halls, public places, etc. The suspension fitting can be delivered in four pendant variations. The construction of the hinge allows for the setting of the shade at any height.

Technology

Product Classification

Name	ESFERA	LUMÉ
Colour	BAS	triplex opal CGC39
SurfaceG	ALL	glossv acid-etched CGSU66 CGSU67
Ornaments	STA	optic - straight CGO464
SurfaceC	ALL	chrome glossv nickel CCS275 CCS287
Bulbs	ALL	E27 - enerav savina 23W bulb E27 - compatible bulb HALOPIN G9 max. 1x2G9 CEB388 CEB476 CEB412
Cable colour	ALL	transparent CECL149
Material	ALL	plastics. PE. silicon glass CCM138 CCM139
Certification	ALL	CE EN 60598-1 EN 60598-2-1 CEC160 CEC567 CEC568

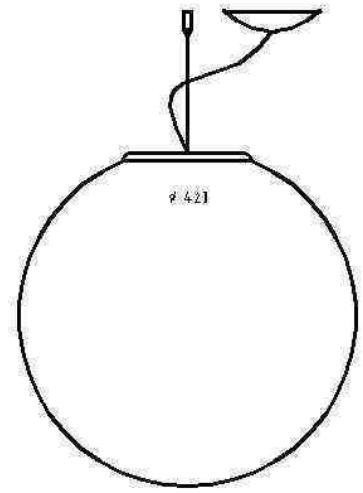

	X	Y	W	Z
PC586	505	1690	490	190

Identification

Name	ESFERA LUMÉ 190
Type	suspension lamp
Collection	ESFERA
Line	Standard Line
Designed by	Alex Linger

BROKIS

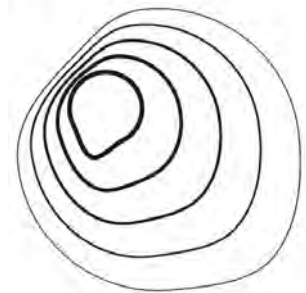

Description

Features

The Lamps from the ESFERA collection are made of triplex opal glass and are suitable for modern interior lighting in living rooms, halls, public places, etc. The suspension fitting can be delivered in four pendant variations. The construction of the hinge allows for the setting of the shade at any height.

Technology

Product Classification

Name	ESFERA	LUMÉ 190
Colour	BAS	triplex opal CGC39
SurfaceG	ALL	glossv acid-etched CGSU66 CGSU67
Ornaments	STA	optic - straight CGO464
SurfaceC	ALL	chrome glossv nickel CCS275 CCS287
Bulbs	ALL	E27 - enerav savina 23W bulb E27 - compatible bulb HALOPIN G9 max. 1x2G9 CEB388 CEB476 CEB412
Cable colour	ALL	transparent CECL149
Material	ALL	plastics. PE. silicon glass CCM138 CCM139
Certification	ALL	CE EN 60598-1 EN 60598-2-1 CEC160 CEC567 CEC568

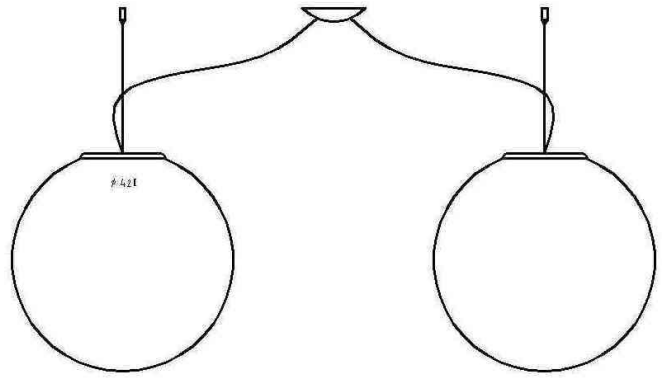

	X	Y	W	Z
PC587	505	1690	490	190

Identification

Name	ESFERA LUMÉ DUO 190
Type	suspension lamp
Collection	ESFERA
Line	Standard Line
Designed by	Alex Linger

BROKIS

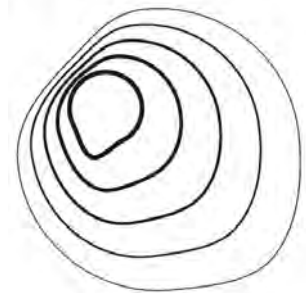

Description

Features

The Lamps from the ESFERA collection are made of triplex opal glass and are suitable for modern interior lighting in living rooms, halls, public places, etc. The suspension fitting can be delivered in four pendant variations. The construction of the hinge allows for the setting of the shade at any height.

Technology

Product Classification

Name	ESFERA	LUMÉ DUO 190
Colour	BAS	triplex opal CGC39
SurfaceG	ALL	glossv acid-etched CGSU66 CGSU67
Ornaments	STA	optic - straight CGO464
SurfaceC	ALL	chrome glossv nickel CCS275 CCS287
Bulbs	ALL	E27 - enerav savina 23W bulb E27 - compatible bulb HALOPIN G9 max. 2x2G9 CEB388 CEB476 CEB413
Cable colour	ALL	transparent CECL149
Material	ALL	plastics. PE. silicon glass CCM138 CCM139
Certification	ALL	CE EN 60598-1 EN 60598-2-1 CEC160 CEC567 CEC568

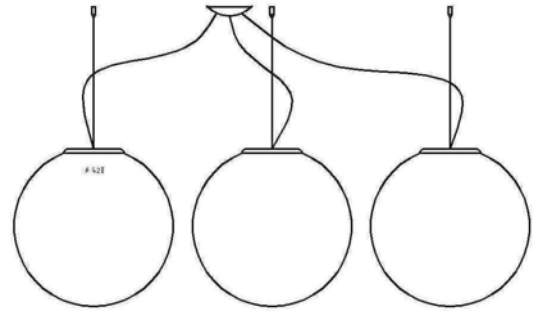

	X	Y	W	Z
PC589	505	1690	490	190

Identification

Name	ESFERA LUMÉ TRIO 190
Type	suspension lamp
Collection	ESFERA
Line	Standard Line
Designed by	Alex Linger

BROKIS

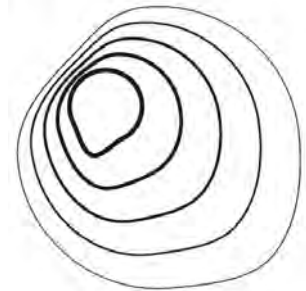

Description

Features

The Lamps from the ESFERA collection are made of triplex opal glass and are suitable for modern interior lighting in living rooms, halls, public places, etc. The suspension fitting can be delivered in four pendant variations. The construction of the hinge allows for the setting of the shade at any height.

Technology

Product Classification

Name	ESFERA	LUMÉ TRIO 190
Colour	BAS	triplex opal CGC39
SurfaceG	ALL	glossv acid-etched CGSU66 CGSU67
Ornaments	STA	optic - straight CGO464
SurfaceC	ALL	chrome glossv nickel CCS275 CCS287
Bulbs	ALL	E27 - enerav savina 23W bulb E27 - compatible bulb HALOPIN G9 max. 3x2G9 CEB388 CEB476 CEB414
Cable colour	ALL	transparent CECL149
Material	ALL	plastics. PE. silicon glass CCM138 CCM139
Certification	ALL	CE EN 60598-1 EN 60598-2-1 CEC160 CEC567 CEC568

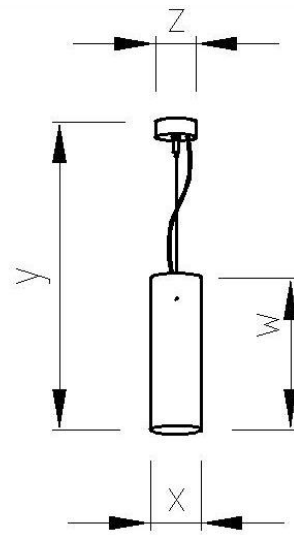

	X	Y	W	Z
PC105	150	1000	500	112

Identification

Name	BLANC CUARTA
Type	suspension lamp
Collection	BLANC
Line	Standard Line
Designed by	Ismael Sugranes

BROKIS

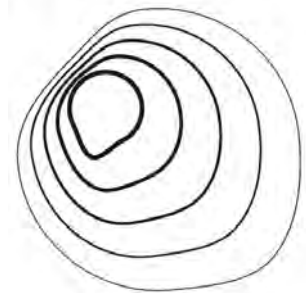

Description

Features	Three-layer suspension lamp consisting of an opal white acid-etched, 500 mm cylinder The lamps of this collection are made of three-layer hand-blown opal white glass. The opal color with grinding (cuts) provides a unique lighting atmosphere. This effect is enhanced by serpentine sections in the glass around the entire perimeter of the shade. It is available with grinding (cuts), or in color combinations of opal glass and other colors, according to the offer.
-----------------	---

Technology

Product Classification

Name	BLANC	CUARTA	
Colour	BAS	triplex opal	CGC39
	STA	internal light amber	CGC144
		light amber - triplex opal	CGC41
		dark amber - triplex opal	CGC42
		verv light amber - triplex opal	CGC40
ADD	green apple - triplex opal	CGC33	
	black - triplex opal	CGC36	
SurfaceG	ALL	glossv	CGSU66
		acid-etched	CGSU67
Ornaments	ADD	horizontal cut	CGO260
		enaravins - evelets	CGO123
		vertical cut	CGO259
		enaravins - snakes	CGO125
SurfaceC	ALL	glossv stainless steel	CCS68
		glossv nickel	CCS287
Bulbs	ALL	bulb E27 - compatible	CEB476
		bulb E27 - enerav savina max. 11W	CEB490
Cable colour	ALL	transparent	CECL149
Material	ALL	carton	CCM140
		metal extrusion	CCM135
		plastics, PE, silicon	CCM138
		glass	CCM139
Certification	ALL	CE	CEC160
		EN 60598-1	CEC567
		EN 60598-2-1	CEC568

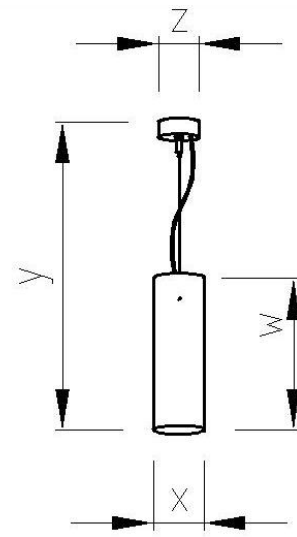

	X	Y	W	Z
PC28	150	1000	300	112

Identification

Name	BLANC CUARTA
Type	suspension lamp
Collection	BLANC
Line	Standard Line
Designed by	Ismael Sugranes

BROKIS

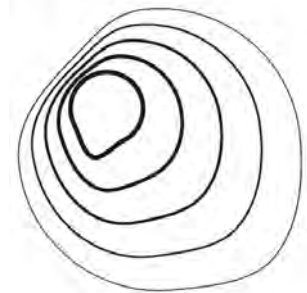

Description

Features	<p>Three-layer suspension lamp made of opal acid-etched glass with incisions. The light produced gives a calm and elegant effect. The glass cylinder has vertical, wavy incisions on the outer layer. More colors available.</p> <p>The lamps of this collection are made of three-layer hand-blown opal white glass. The opal color with grinding (cuts) provides a unique lighting atmosphere. This effect is enhanced by serpentine sections in the glass around the entire perimeter of the shade. It is available with grinding (cuts), or in color combinations of opal glass and other colors, according to the offer.</p>
-----------------	---

Technology

Product Classification

Name	BLANC	CUARTA	
Colour	BAS	triplex opal	CGC39
	STA	internal light amber	CGC144
		light amber - triplex opal	CGC41
		dark amber - triplex opal	CGC42
		verv light amber - triplex opal	CGC40
ADD	green apple - triplex opal	CGC33	
	black - triplex opal	CGC36	
SurfaceG	BAS	glossv	CGSU66
		acid-etched	CGSU67
Ornaments	ADD	horizontal cut	CGO260
		enravins - evelets	CGO123
		vertical cut	CGO259
		enravins - snakes	CGO125
SurfaceC	ALL	glossv stainless steel	CCS68
		glossv nickel	CCS287
Bulbs	ALL	bulb E27 - compatible	CEB476
		bulb E27 - enerav savina max. 11W	CEB490
Cable colour	ALL	transparent	CECL149
Material	ALL	carton	CCM140
		metal extrusion	CCM135
		plastics, PE, silicon	CCM138
		glass	CCM139
Certification	ALL	CE	CEC160
		EN 60598-1	CEC567
		EN 60598-2-1	CEC568

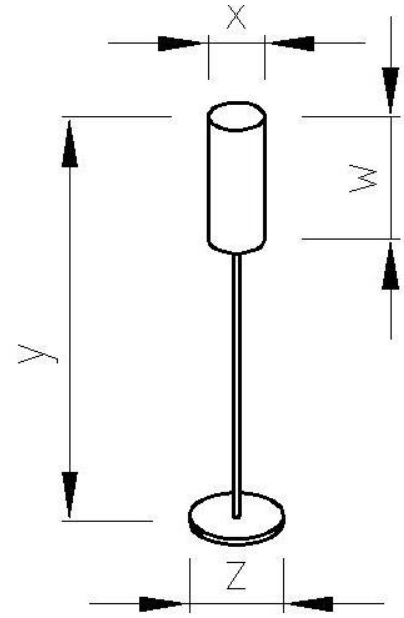

	X	Y	W	Z
PC40	150	1925	500	250

Identification

Name	BLANC TERCERA
Type	floor lamp
Collection	BLANC
Line	Standard Line
Designed by	Ismael Sugranes

BROKIS

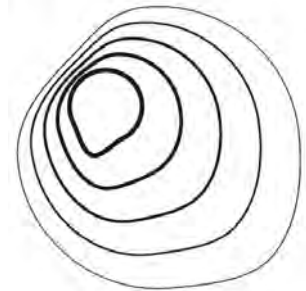

Description

Features	<p>Three-layer floor lamp consisting of an opal white acid-etched, 500 mm cylinder.</p> <p>The lamps of this collection are made of three-layer hand-blown opal white glass. The opal color with grinding (cuts) provides a unique lighting atmosphere. This effect is enhanced by serpentine sections in the glass around the entire perimeter of the shade. It is available with grinding (cuts), or in color combinations of opal glass and other colors, according to the offer.</p>
-----------------	--

Technology

Product Classification

Name	BLANC	TERCERA	
Colour	BAS	triplex opal	CGC39
	STA	internal light amber	CGC144
		light amber - triplex opal	CGC41
		very light amber - triplex opal	CGC40
		green apple - triplex opal	CGC33
ADD	black - triplex opal	CGC36	
SurfaceG	ALL	glossy	CGSU66
		acid-etched	CGSU67
Ornaments	ADD	horizontal cut	CGO260
		enaravins - evelets	CGO123
		vertical cut	CGO259
		enaravins - snakes	CGO125
SurfaceC	ALL	glossy stainless steel	CCS68
		glossy nickel	CCS287
Bulbs	ALL	bulb E27 - compatible	CEB476
	BAS	bulb E27 energy saving max. 11W	CEB435
	STA	bulb E27 -energy saving max. 20W	CEB475
	ADD	E27 -DIM max. 20W	CEB436
Cable colour	ALL	transparent	CECL149
Switch	BAS	bipolar foot switch	CES154
	STA	black dimmer - table	CES474
		transparent dimmer - table	CES99
	ADD		
Material	ALL	carton	CCM140
		metal extrusion	CCM135
		plastics, PE, silicon	CCM138
		glass	CCM139
Certification	ALL	CE	CEC160
		EN 60598-1	CEC569
		EN 60598-2-4	CEC570

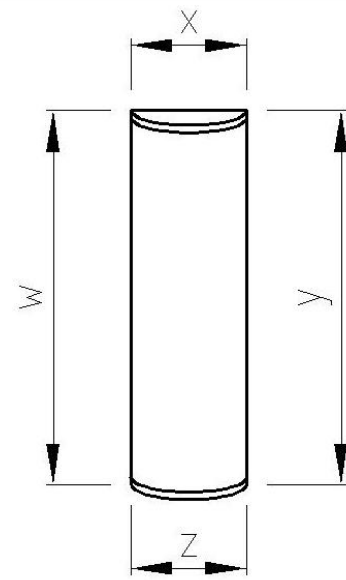

	X	Y	W	Z
PC699	150	500	500	150

Identification

Name	BLANC VETRO
Type	wall lamp
Collection	BLANC
Line	Standard Line
Designed by	Ismael Sugranes

BROKIS

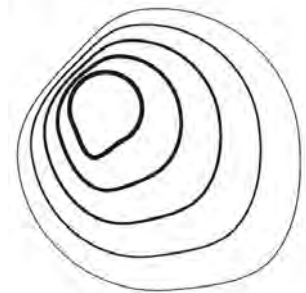

Description

Features

The lamps of this collection are made of three-layer hand-blown opal white glass. The opal color with grinding (cuts) provides a unique lighting atmosphere. This effect is enhanced by serpentine sections in the glass around the entire perimeter of the shade. It is available with grinding (cuts), or in color combinations of opal glass and other colors, according to the offer.

Technology

Product Classification

Name	BLANC	VETRO	
Colour	BAS	transparent triplex opal	CGC23 CGC39
	STA	light amber - triplex opal	CGC41
SurfaceG	ALL	glossy acid-etched	CGSU66 CGSU67
	ADD	vertical cut enaravinas - snakes	CGO259 CGO125
SurfaceC	ALL	chrome	CCS275
Bulbs	ALL	fluorescent tube T1U max 11W	CEB449
Switch	ALL	VVG - magnetic control gears - chokina coils	CES249
Material	ALL	glass	CCM139
Certification	ALL	CE	CEC160
		EN 60598-1	CEC567
		EN 60598-2-1	CEC568

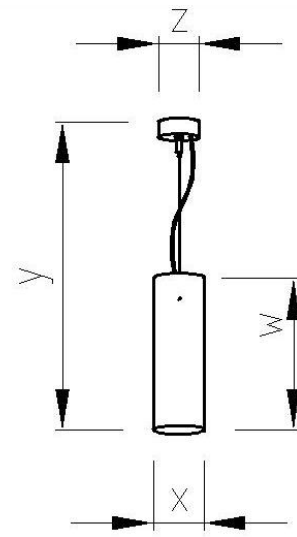

	X	y	w	Z
PC723	80	1000	350	112

Identification

Name	BLANC CUARTA
Type	suspension lamp
Collection	BLANC
Line	Standard Line
Designed by	Ismael Sugranes

BROKIS

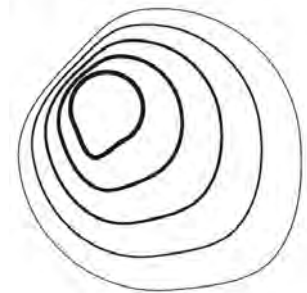

Description

Features

The lamps of this collection are made of three-layer hand-blown opal white glass. The opal color with grinding (cuts) provides a unique lighting atmosphere. This effect is enhanced by serpentine sections in the glass around the entire perimeter of the shade. It is available with grinding (cuts), or in color combinations of opal glass and other colors, according to the offer.

Technology

Product Classification

Name	BLANC	CUARTA	
Colour	BAS	triplex opal	CGC39
	STA	internal light amber	CGC144
		light amber - triplex opal	CGC41
		dark amber - triplex opal	CGC42
		verv light amber - triplex opal	CGC40
ADD	green apple - triplex opal	CGC33	
	black - triplex opal	CGC36	
SurfaceG	ALL	glossv	CGSU66
		acid-etched	CGSU67
Ornaments	ADD	horizontal cut	CGO260
		enaravins - evelets	CGO123
		vertical cut	CGO259
		enaravins - snakes	CGO125
SurfaceC	ALL	glossv stainless steel	CCS68
		glossv nickel	CCS287
Bulbs	ALL	bulb E14 - compatible	CEB494
		bulb E14 - max. 11W	CEB495
Cable colour	ALL	transparent	CECL149
Material	ALL	carton	CCM140
		metal extrusion	CCM135
		plastics, PE, silicon	CCM138
		glass	CCM139
Certification	ALL	CE	CEC160
		EN 60598-1	CEC567
		EN 60598-2-1	CEC568

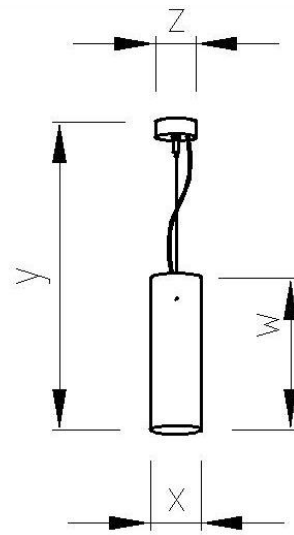

	X	Y	W	Z
PC724	80	1000	500	112

Identification

Name	BLANC CUARTA
Type	suspension lamp
Collection	BLANC
Line	Standard Line
Designed by	Ismael Sugranes

BROKIS

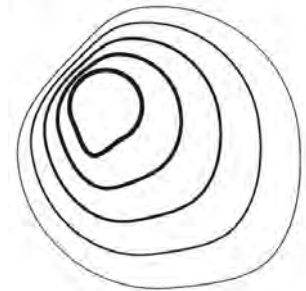

Description

Features

The lamps of this collection are made of three-layer hand-blown opal white glass. The opal color with grinding (cuts) provides a unique lighting atmosphere. This effect is enhanced by serpentine sections in the glass around the entire perimeter of the shade. It is available with grinding (cuts), or in color combinations of opal glass and other colors, according to the offer.

Technology

Product Classification

Name	BLANC	CUARTA	
Colour	BAS	triplex opal	CGC39
	STA	internal light amber	CGC144
		light amber - triplex opal	CGC41
		dark amber - triplex opal	CGC42
		verv light amber - triplex opal	CGC40
ADD	green apple - triplex opal	CGC33	
	black - triplex opal	CGC36	
SurfaceG	ALL	glossv	CGSU66
		acid-etched	CGSU67
Ornaments	ADD	horizontal cut	CGO260
		enaravins - evelets	CGO123
		vertical cut	CGO259
		enaravins - snakes	CGO125
SurfaceC	ALL	glossv stainless steel	CCS68
		glossv nickel	CCS287
Bulbs	ALL	bulb E14 - compatible	CEB494
		bulb E14 - max. 11W	CEB495
Cable colour	ALL	transparent	CECL149
Material	ALL	carton	CCM140
		metal extrusion	CCM135
		plastics, PE, silicon	CCM138
		glass	CCM139
Certification	ALL	CE	CEC160
		EN 60598-1	CEC567
		EN 60598-2-1	CEC568

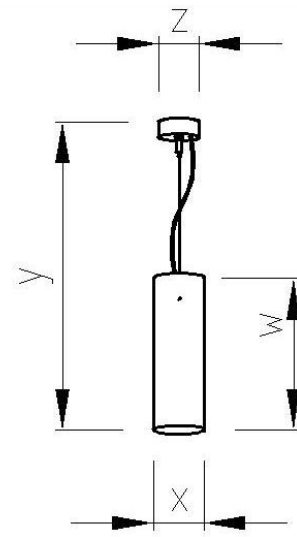

	X	Y	W	Z
PC725	120	1000	380	112

Identification

Name	BLANC CUARTA
Type	suspension lamp
Collection	BLANC
Line	Standard Line
Designed by	Ismael Sugranes

BROKIS

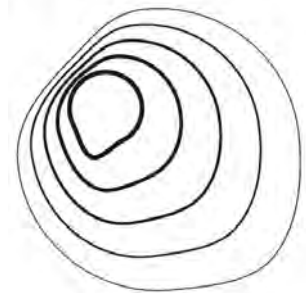

Description

Features

The lamps of this collection are made of three-layer hand-blown opal white glass. The opal color with grinding (cuts) provides a unique lighting atmosphere. This effect is enhanced by serpentine sections in the glass around the entire perimeter of the shade. It is available with grinding (cuts), or in color combinations of opal glass and other colors, according to the offer.

Technology

Product Classification

Name	BLANC	CUARTA	
Colour	BAS	triplex opal	CGC39
	STA	internal light amber	CGC144
		light amber - triplex opal	CGC41
		dark amber - triplex opal	CGC42
		verv light amber - triplex opal	CGC40
ADD	green apple - triplex opal	CGC33	
	black - triplex opal	CGC36	
SurfaceG	ALL	glossv	CGSU66
		acid-etched	CGSU67
Ornaments	ADD	horizontal cut	CGO260
		enaravins - evelets	CGO123
		vertical cut	CGO259
		enaravins - snakes	CGO125
SurfaceC	ALL	glossv stainless steel	CCS68
		glossv nickel	CCS287
Bulbs	ALL	bulb E27 - compatible	CEB476
		bulb E27 - enerav savina max. 11W	CEB490
Cable colour	ALL	transparent	CECL149
Material	ALL	carton	CCM140
		metal extrusion	CCM135
		plastics, PE, silicon	CCM138
		glass	CCM139
Certification	ALL	CE	CEC160
		EN 60598-1	CEC567
		EN 60598-2-1	CEC568

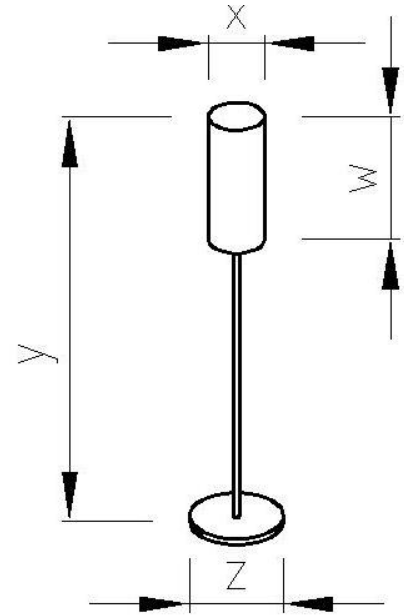

	X	y	w	z
PC726	150	1920	300	250

Identification

Name	BLANC TERCERA
Type	floor lamp
Collection	BLANC
Line	Standard Line
Designed by	Ismael Sugranes

BROKIS

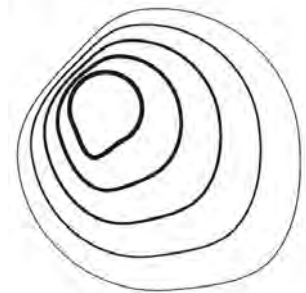

Description

Features

The lamps of this collection are made of three-layer hand-blown opal white glass. The opal color with grinding (cuts) provides a unique lighting atmosphere. This effect is enhanced by serpentine sections in the glass around the entire perimeter of the shade. It is available with grinding (cuts), or in color combinations of opal glass and other colors, according to the offer.

Technology

Product Classification

Name	BLANC	TERCERA	
Colour	BAS	triplex opal	CGC39
	STA	internal light amber	CGC144
		light amber - triplex opal	CGC41
		dark amber - triplex opal	CGC42
		verv light amber - triplex opal	CGC40
ADD	green apple - triplex opal	CGC33	
SurfaceG	ALL	black - triplex opal	CGC36
		glossv	CGSU66
SurfaceG	ALL	acid-etched	CGSU67
Ornaments	ADD	horizontal cut	CGO260
		enoravins - evelets	CGO123
		vertical cut	CGO259
		enoravins - snakes	CGO125
SurfaceC	ALL	glossv stainless steel	CCS68
		glossv nickel	CCS287
Bulbs	ALL	bulb E27 - compatible	CEB476
	BAS	bulb E27 enerav savina max. 11W	CEB435
	STA	E27 -DIM max. 20W	CEB436
	ADD	bulb E27 -enerav savina max. 20W	CEB475
Cable colour	ALL	transparent	CECL149
Switch	BAS	bipolar foot switch	CES154
	STA	black dimmer - table	CES474
	ADD	transparent dimmer - table	CES99
Material	ALL	carton	CCM140
		metal extrusion	CCM135
		plastics, PE, silicon	CCM138
		glass	CCM139
Certification	ALL	CE	CEC160
		EN 60598-1	CEC569
		EN 60598-2-4	CEC570

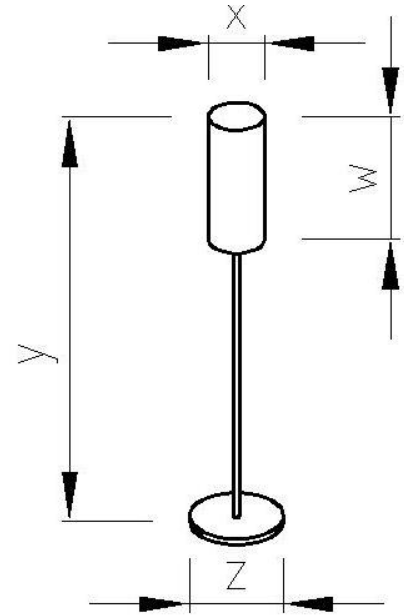

	X	Y	W	Z
PC727	120	1920	380	250

Identification

Name	BLANC TERCERA
Type	floor lamp
Collection	BLANC
Line	Standard Line
Designed by	Ismael Sugranes

BROKIS

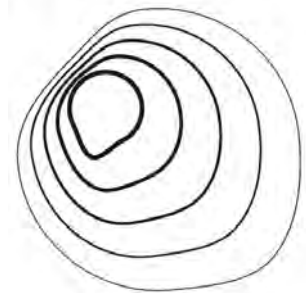

Description

Features

The lamps of this collection are made of three-layer hand-blown opal white glass. The opal color with grinding (cuts) provides a unique lighting atmosphere. This effect is enhanced by serpentine sections in the glass around the entire perimeter of the shade. It is available with grinding (cuts), or in color combinations of opal glass and other colors, according to the offer.

Technology

Product Classification

Name	BLANC	TERCERA	
Colour	BAS	triplex opal	CGC39
	STA	internal light amber	CGC144
		light amber - triplex opal	CGC41
		dark amber - triplex opal	CGC42
		verv light amber - triplex opal	CGC40
	ADD	green apple - triplex opal	CGC33
black - triplex opal		CGC36	
SurfaceG	ALL	glossv	CGSU66
		acid-etched	CGSU67
Ornaments	ADD	horizontal cut	CGO260
		enoravins - evelets	CGO123
		vertical cut	CGO259
		enoravins - snakes	CGO125
SurfaceC	ALL	glossv stainless steel	CCS68
		glossv nickel	CCS287
Bulbs	ALL	bulb E27 - compatible	CEB476
	BAS	bulb E27 enerav savina max. 11W	CEB435
	STA	E27 -DIM max. 20W	CEB436
	ADD	bulb E27 -enerav savina max. 20W	CEB475
Switch	BAS	bipolar foot switch	CES154
	STA	black dimmer - table	CES474
	ADD	transparent dimmer - table	CES99
Material	ALL	carton	CCM140
		metal extrusion	CCM135
		plastics, PE, silicon	CCM138
		glass	CCM139
Certification	ALL	CE	CEC160
		EN 60598-1	CEC569
		EN 60598-2-4	CEC570