

LIGHT&LIVING



DILUCE

LIVING DESIGN

NEW COLLECTIONS

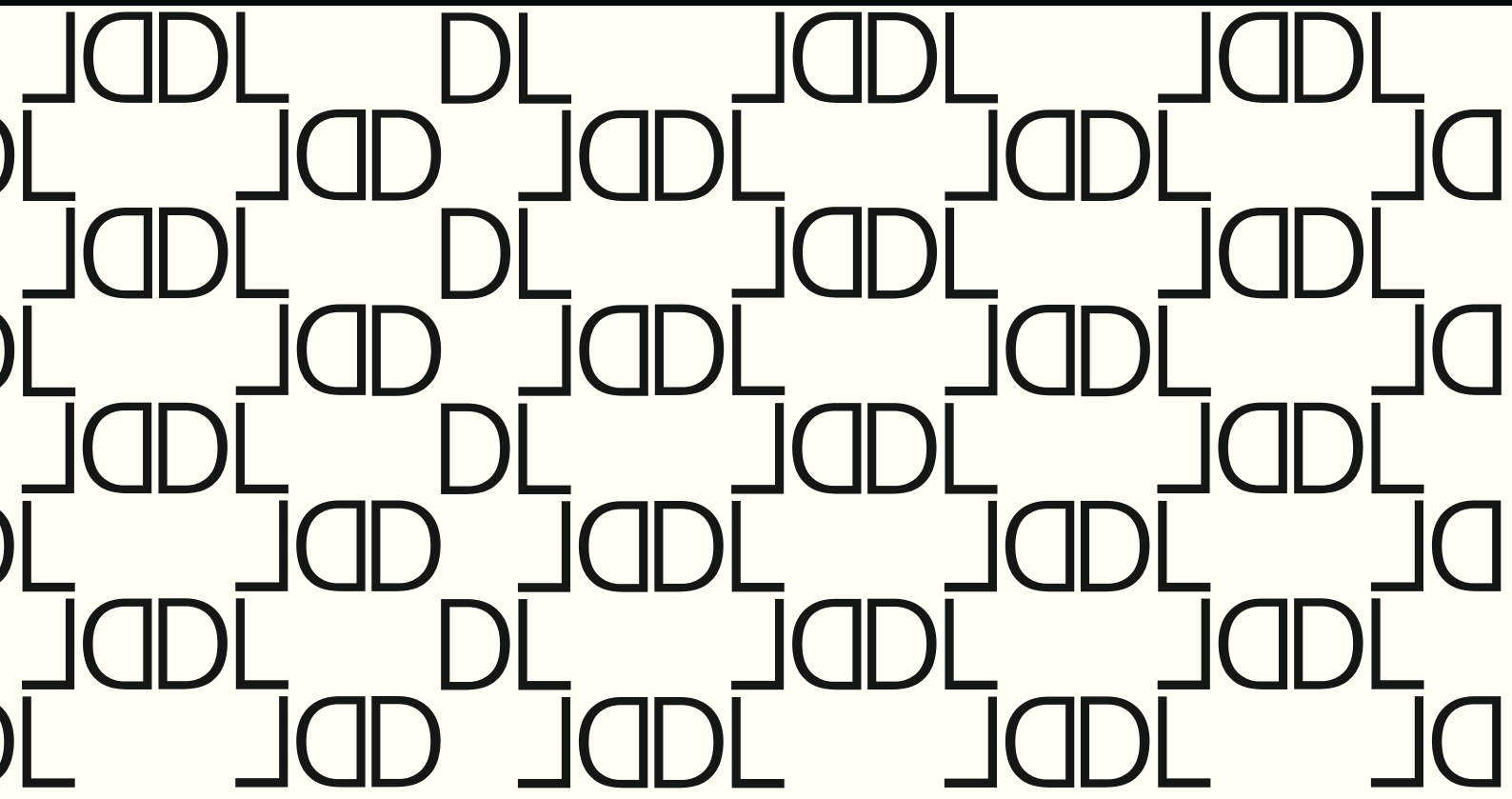

BEBY
ITALY
LIGHT&LIVING



CRYSTAL RAIN pag. 2



PRINCESS pag. 8



MON TRÉSOR pag. 18



MISS BIJOUX pag. 28



PRIVILEGE pag. 40



PRIVÉ pag. 46



VIOLET pag. 60



SILVER NIGHT pag. 64



PRESTIGE pag. 78



GARDEN PARTY ANTIGUA RUM pag. 88



VANITÉ pag. 92



QUEEN OF ROSES pag. 100



BEBY ROSE MASTERPIECE pag. 120



MADEMOISELLE COROLLE pag. 124



PRIVATE PROJECTS pag. 132



COLOUR CARDS pag. 184



TECHNICAL DETAILS pag. 192

Una collezione **ispirata al concept del ghiaccio**, interpretato come vera e propria cascata di luce e cristallo, artefice di algide ed incontaminate atmosfere all'insegna della purezza e dell'eleganza più assoluta che nasce dalla ricercata alternanza tra materiali costruttivi e design.

La struttura in metallo cromato, con cavi di fissaggio in acciaio, si fonde visivamente con i listelli in vetro di **Murano colorato, Golden Teak e Trasparente**, che integrano l'esclusiva **tecnologia costruttiva brevettata HidIN'** in grado di offrire una straordinaria scelta di nuance e combinazioni cromatiche.

Velate e quasi impalpabili sfumature di colore che si infiammano grazie all'illuminazione con tecnologia led a doppia accensione in grado di riverberare con estrema forza l'intensa luce scenica che scaturisce dai cristalli **SWAROVSKI ELEMENTS**, nelle esclusive colorazioni **Bronze Shade e Blue Shade**, che esprimono straordinarie sensazioni di leggerezza e sublime purezza.

CRYSTAL RAIN

A collection **inspired by a frozen concept**, interpreted as a real waterfall of light and crystal, creator of icy and pristine atmosphere in the name of absolute purity and elegance, coming from alternation between refined manufacturing and design.

Chromed metal frame suspended by steel fixing cables, fuses visually with strips of colored **Murano glass, in Golden Teak and Transparent**, complemented by the exclusive patented **technology HidIN'**, offering an extraordinary range of shades and color combinations.

Impalpable nuances and veiled, becoming inflamed by LED lighting technology with double ignition, are capable to reverberate with extreme force the intense stage lighting coming from **SWAROVSKI ELEMENTS** in exclusive colors **Bronze Shade and Blue Shade**, expressing extraordinary sensations of lightness and sublime purity.





0230B01

Ø 105 cm - H. 51 cm - kg 20

10 x E14 max 40 watt + 10 LED 0,5 watt



0230B01

Ø 105 cm - H. 51 cm - kg 20

10 x E14 max 40 watt + 10 LED 0,5 watt





0230B02

Ø 111 cm - H. 55 cm - kg 21

10 x E14 max 40 watt + 10 LED 0,5 watt

La collezione **Princess** è la reinterpretazione in chiave moderna della collezione **Queen of Roses**, progettata dalla **designer Silvia Broggian** per integrarsi all'interno di spazi architettonici moderni caratterizzati da soffitti con altezze contenute grazie ad un design completamente modulare e dedicato a nuove forme e concept estetici.

Suggerimenti stilistiche votate ad inediti ideali di eleganza che prendono vita grazie alla sinuosa struttura in **vetro di Murano**, con tecnologia costruttiva brevettata **HidIN'**, ai pendenti **SWAROVSKI ELEMENTS** nell'esclusiva **colorazione Bronze Shade**, ed alle **luci a LED con doppia accensione**, in grado di garantire una perfetta illuminazione funzionale ed una straordinaria luce scenica.

Ricercati dettagli estetici che si completano negli abbinamenti con le coppe di cristallo, con **SWAROVSKI ELEMENTS** incastonati, ed i portalamпада in metallo con finitura coordinata ai corpi illuminanti, o con i paralumi in raffinato tessuto con emblema in **SWAROVSKI ELEMENTS** termosaldati delle eleganti lampade da tavolo.

PRINCESS

Princess collection is the modern reinterpretation of the **Queen of Roses** collection designed by **designer Silvia Broggian** to be integrated into modern architectural spaces, featured with low ceiling heights and thanks to a fully modular design and dedicated to new forms and aesthetic concepts.

Stylish suggestions devoted to unpublished ideals of elegance come to life through the sinuous structure in **Murano glass**, with construction technology patented **HidIN'**, with **SWAROVSKI ELEMENTS** in the exclusive color **Bronze Shade**, and to **LED lights in double switch**, able to guarantee a perfect functional lighting and an extraordinary scene.

Selected aesthetic details are combined to crystal cups, embedded with **SWAROVSKI ELEMENTS**, and metal lamp holders with finish matching lighting structures, or with fine fabric lampshades with welded

SWAROVSKI ELEMENTS emblem for elegant table lamps.





9010A01

L. 32 cm - W. 20 cm - H. 55 cm - kg 4
3 x E14 max 40 watt + 2 LED 1,2 watt



9010B01

Ø 137 cm - H. 108 cm - kg 50
30 x E14 max 40 watt + 6 LED 1,2 watt



9010L01
Ø 20 cm - H. 79 cm - kg 3
1 x E14 max 40 watt



9010L02
47 cm x 29 cm - H. 76 cm - kg 4
2 x E14 max 40 watt



9010A01

L. 32 cm - W. 20 cm - H. 55 cm - kg 4
3 x E14 max 40 watt + 2 LED 1,2 watt



9010B01

Ø 137 cm - H. 108 cm - kg 51

30 x E14 max 40 watt + 6 LED 1,2 watt



9010B04

Ø 137 cm - H. 85 cm - kg 49

30 x E14 max 40 watt + 6 LED 1,2 watt



9010B02

Ø 100 cm - H. 85 cm - kg 30
12 x E14 max 40 watt + 6 LED 1,2 watt

Ispirata agli inconfondibili dettami stilistici del mondo **Déco**, la collezione **Mon Trésor** è caratterizzata da forme e linee essenziali, che disegnano curve ampie e profondamente avvolgenti in grado di enfatizzare lo sviluppo orizzontale delle creazioni a sospensione.

Progettati appositamente per ambienti con altezze contenute, gli chandelier **Mon Trésor** si sviluppano intorno ad un telaio centrale con speciale finitura ottenuta tramite processi di elettrocolorazione, che permettono di ricreare nuance più intense ed offrire una gamma cromatica più ampia ed articolata. I dischi in **vetro di Murano bicolore**, alla base degli elementi portalampada, creano affascinanti rifrazioni e diffrazioni della luce, a loro volta amplificate dalla lucentezza dei paralumi cilindrici in fine tessuto laminato con finitura dorata.

Sensazione eteree di impalpabile equilibrio, enfatizzate dai cristalli **SWAROVSKI ELEMENTS** nelle colorazioni **Bronze Shade e Golden Shadow**, raccolti in composizioni con sistema di fissaggio invisibile a sospensione che amplifica le sensazioni di leggerezza e di armoniosità dell'intera creazione.

MON TRÉSOR

Inspired by the unmistakable stylistic dictates of the **Déco** world, the collection **Mon Trésor** is characterized by essential lines and shapes, which draw sweeping and deeply enveloping curves able to emphasize the horizontal development of the suspended creations.

Specially designed for environments with reduced heights, chandeliers of **Mon Trésor** collection are surrounded by frames decorated with a special finish obtained by electro-processes, creating intense nuances and offering a wide chromatic selection. The **bicolor Murano glass** plates, laying at the base of each lamp holder, create fascinating refractions and diffractions of light, amplified by the sparkling of cylindrical lampshades manufactured with refined laminated fabric with golden finish.

Ethereal feeling of intangible equilibrium, emphasized by **SWAROVSKI ELEMENTS** in colors of **Bronze Shade and Golden Shadow**, collected and suspended in compositions by and invisible fixing system which enhances the sensations of lightness and harmony of the entire creation.

ITALY
LIGHT&LIVING
CHOCOLATE





0126A02

L. 32,5 cm - W. 24 cm - H. 55 cm - kg 2

2 x G9 max 40 watt



0126B07
Ø 133 cm - H. 76 cm - kg 16
16 x G9 max 40 watt



0126P01
Ø 53 cm - H. 158 cm - kg 20
1 E27 max 100 watt



0126B02
Ø 90 cm - H. 76 cm - kg 10
8 x G9 max 40 watt





0126B02
Ø 90 cm - H. 76 cm - kg 10
8 x G9 max 40 watt



0126L01
Ø 25 cm - H. 50 cm - kg 4
1 x G9 max 40 watt



0126L02
Ø 53 cm - H. 100 cm - kg 12
1 x E27 max 60 watt

Elegante e fortemente contemporanea, la collezione **Miss Bijoux** è simbolo del **perfetto equilibrio tra la classicità delle linee elegantemente retrò**, le esclusive lavorazioni delle finiture e le importanti innovazioni costruttive, tecniche e funzionali che caratterizzano i modelli di chandelier, applique, piantana e lampada da tavolo.

Un carattere intrigante e moderno che si manifesta in tutto il suo splendore grazie anche alla **struttura in metallo verniciata bianca con effetto perlato**, abbinata ai sontuose catene di **SWAROVSKI ELEMENTS**, proposti nella **nuova nuance Silver Night**, creando affascinanti ed emozionali intrecci.

I paralumi in nastro doppio raso sono confezionati artigianalmente per creare raffinati effetti chiaroscurali, enfatizzati dalla tecnologia a doppia accensione con led dedicati all'illuminazione decorativa.

Si crea così un'esaltazione dell'eleganza delle colorazioni neutre del telaio in contrapposizione alla vivacità della vastissima gamma cromatica disponibile per i tessuti e i pendenti in abbinamento.

MISS BIJOUX

Elegant and highly contemporary, the **Miss Bijoux** collection is a symbol of the **perfect balance between classic lines elegantly retro**, the exclusive work of trimmings and the important construction innovations, both technical and functional, characterizing chandeliers, wall lamps, floor lamp and table lamp.

A modern and intriguing character that manifests itself in all its splendor thanks to **the metal frame painted white with pearl effect**, combined with the magnificent range of **SWAROVSKI ELEMENTS**, proposed in the **new shade Silver Night**, creating fascinating and emotional entanglements.

The handcraft lampshades made of double satin ribbon are giving refined optical effects, emphasized by a double-switch with decorative led lighting.

This creates an exaltation of the elegance of the neutral colors of frame as opposed to the liveliness of the wide range of colors available for matching tissues and crystals.





0117B01

Ø 80 cm - H. 68 cm - kg 6

6 x G9 max 40 watt + 3 LED 0,5 watt



0117B03
Ø 100 cm - H. 75 cm - kg 7
10 x G9 max 40 watt + 3 LED 0,5 watt



0117A02

L. 36 cm - W. 20 cm - H. 48 cm - kg 2
2 x G9 max 40 watt + 2 LED 0,5 watt



0117B01

Ø 80 cm - H. 68 cm - kg 6
6 x G9 max 40 watt + 3 LED 0,5 watt



0117P01

Ø 46,5 cm - H. 166 cm - kg 15
5 x G9 max 25 watt + 3 LED 0,5 watt



0117B05
Ø 117 cm - H. 85 cm - kg 8
18 x G9 max 40 watt + 3 LED 0,5 watt



0117A01

Ø 14 cm - W. 22 cm - H. 40 cm - kg 1
1 x G9 max 40 watt + 1 LED 0,5 watt



0117L01
Ø 46,5 cm - H. 65 cm - kg 2
1 x E27 max 60 watt



0117L02
Ø 14 cm - H. 32 cm - kg 1
1 LED 1,2 watt



0117L02
Ø 14 cm - H. 32 cm - kg 1
1 LED 1,2 watt

Interamente votata all'esaltazione della straordinaria energia dei colori, la collezione **Privilège** è dedicata ad ambienti giovani, dinamici e moderni, ed è stata progettata seguendo i dettami del design modulare che permette di personalizzare il numero di luci, e conseguentemente la dimensione di ogni singola creazione, per adattarla alle più variegata soluzioni architettoniche.

Un design lineare e profondamente attuale che si arricchisce di espressività nell'accostamento tra la struttura centrale in metallo cromato o oro chiaro ed i listelli in **vetro di Murano colorato**, completati con la tecnologia brevettata **HidIN'**, in grado di offrire una impareggiabile scelta di colorazioni e combinazioni cromatiche abbinata agli **SWAROVSKI ELEMENTS** pendenti.

Elementi decorativi di grande fascino che, nell'elegante abbinamento con i dischi dei portalampada in metallo con emblema **Beby Italy** finemente inciso, simboleggiano l'attenzione e la cura per i dettagli costruttivi, funzionali ed ornamentali.

PRIVILÈGE

Entirely devoted to the exaltation of the extraordinary energy of colors, the **Privilège** collection is dedicated to young environments young, dynamic and modern, and has been designed according to the dictates of a modular design allowing you to customize the number of lights, and consequently the size of each creation, to suit the most varied architectural solutions.

A linear and deeply contemporary design which is enhanced by an expressive approach between the central structure in chromed or light gold metal and strips of **colored Murano glass**, completed by the patented technology **HidIN'**, offering an unrivaled choice of colors and nuance combinations with hanging **SWAROVSKI ELEMENTS**. Decorative elements of a great charm, elegantly matching of metal plates of lamp holders, finely engraved with **Beby Italy** emblem, are symbolizing the care and attention to any detail structural, such as functional and even ornamental.





0240B02
Ø 64 cm - H. 37 cm - kg 6
8 x E14 max 40 watt



0240B03
Ø 80 cm - H. 37 cm - kg 7
10 x E14 max 40 watt



0240A01
L. 43 cm - W. 28 cm - H. 37 cm - kg 4
3 x E14 max 40 watt



0240B01
Ø 56 cm - H. 37 cm - kg 4
5 x E14 max 40 watt

Un ricercato connubio tra la sontuosa eleganza degli chandelier in **stile Maria Teresa** ed una moderna interpretazione di volumi e linee di costruzione contemporanee: la collezione **Privé** raccoglie l'eredità di uno stile senza tempo e la trasforma in creazioni dal carattere moderno, ricche di tendenza ed intense sfumature glamour.

Contaminazioni stilistiche simboleggiate dalla **fusione tra il metallo della struttura**, realizzata in diverse finiture ed in un'**ampia gamma di colorazioni originali**, ed i **listelli in vetro di Murano** con **tecnologia brevettata HidIN'**, disponibili in versione trasparente o colorata, in grado di amplificare le sensazioni di pulizia e purezza, o riverberare l'energia del colore grazie alla **tecnologia a doppia accensione ed i led decorativi** dedicati.

Impareggiabili effetti di luce enfatizzati dai paralumi con pregiata lavorazione sartoriale a nastro, che crea affascinanti giochi di ombre e velate intriganti sfumature, che si riflettono sui cristalli **SWAROVSKI ELEMENTS** pendenti, sulle medaglie pendenti con **stemma Beby Italy** ad incisione orafa, o sulle sinuose fiamme in vetro di Murano disponibili in oltre venti raffinate nuance.

PRIVÉ

A sophisticated concoction of the sumptuous elegance peculiar to the **Maria Teresa style** of chandeliers and of its modern interpretation marked by lines and volumes of a more contemporary conception: the **Privé** collection takes up the legacy of a timeless style to develop creations of a modern character, rich in influence and intense hues of glamour.

A stylistic blend exemplified by the synthesis of a **metal frame**, realized in various finishings and a **wide range of original colorings**, and the **Murano glass listel**, with its **HidIN' patented technology** available in clear and colored version, capable of conveying sensations of refinement and purity while magnifying the energy of color thanks to **double switch technology and decorative LED lights**.

Unequaled light effects emphasized by a refined handmade tailoring creates fascinating shadow effects and dim, intriguing hues which, in turn, reflects upon the **SWAROVSKI ELEMENTS** crystal pendants, upon the medal pendants engraved with **Beby Italy emblem**, upon the Murano glass sinuous flames available in more than twenty different, refined nuances.





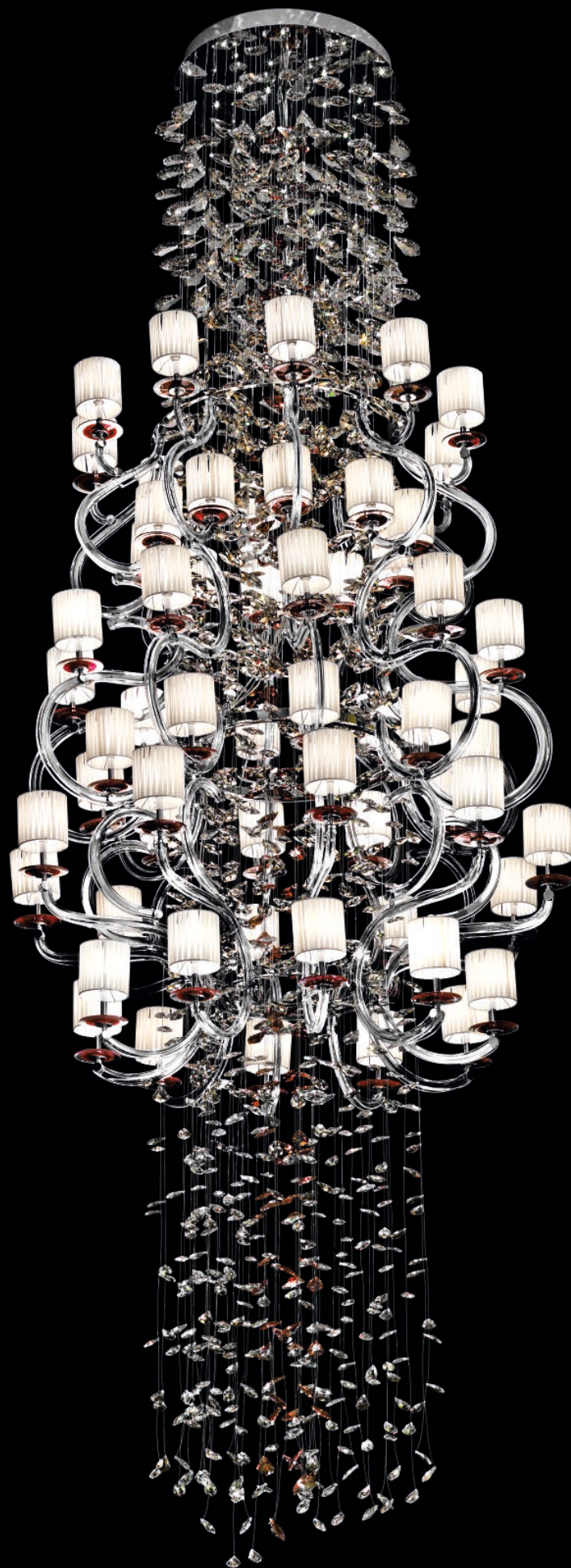

0210B07

Ø 150 cm - H. 400 cm - kg 180

60 x G9 max 40 watt

+ 11 LED 1,2 watt + 23 LED 0,5 watt

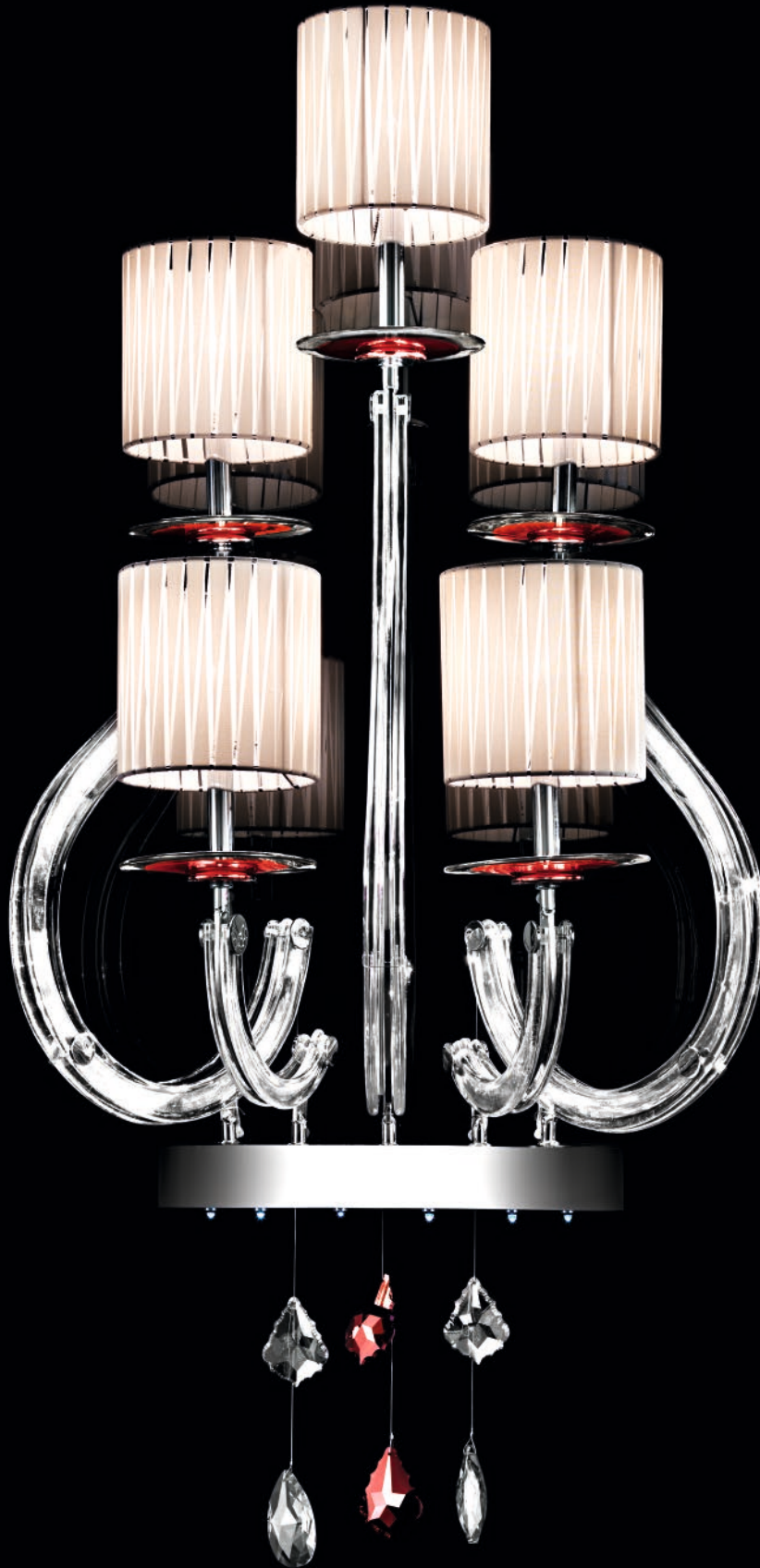

0210A04

L. 45 cm - W. 30 cm - H. 90 cm - kg 6
5 x G9 max 40 watt + 6 LED 0,5 watt



0210B08

Ø 85 cm - H. 100 cm - kg 15
 10 x G9 max 40 watt + 15 LED 0,5 watt



0215A03

L. 38 cm - W. 15 cm - H. 90 cm - kg 4

2 x G9 max 40 watt + 2 LED 1,2 watt + 3 LED 0,5 watt



0215B03

Ø 115 cm - H. 80 cm - kg 22

12 x G9 max 40 watt + 12 LED 1,2 watt + 6 LED 0,5 watt



0210P01
Ø 35 cm - H. 185 cm - kg 22
1 x E27 max 60 watt



0220B01

120 cm x 54 cm - H. 52 cm - kg 20
14 x G9 max 40 watt + 14 LED 0,5 watt



0220B04

Ø 75 cm - H. 52 cm - kg 12
10 x G9 max 40 watt + 6 LED 0,5 watt



0220B04

Ø 75 cm - H. 52 cm - kg 12
10 x G9 max 40 watt + 6 LED 0,5 watt





0220A02

L. 36 cm - W. 20 cm - H. 52 cm - kg 2
2 x G9 max 40 watt + 3 LED 0,5 watt

La collezione **Violet** si tinge di una nuovissima ed esclusiva **colorazione rosé** ispirata alle nuance protagoniste delle ultime stagioni della moda, in grado di incarnare ideali di classe, eleganza ed intensa femminilità.

Caratteristiche che emergono con forza grazie all'estrema leggerezza delle linee della **struttura in metallo lucidato** ed all'attenta progettazione dei pesi che enfatizzano una silhouette ricca di grazia e di linearità stilistica, frutto di una profonda reinterpretazione dei volumi classici in chiave fortemente contemporanea.

Uno stile moderno ed attuale, dedicato ad ambienti giovani e dinamici in cui prendono forma giochi di toni, lucentezze e sfumature che nascono dall'abbinamento tra la purezza dei cristalli pendenti **SWAROVSKI ELEMENTS** nei tagli geometrici ed a goccia, e l'eleganza dei **paralumi con lavorazione sartoriale**, in grado di diffondere una luce profondamente suggestiva e coinvolgente.

VIOLET *Rosé*

Violet collection is now tinged with an absolutely new and **exclusive coloration** inspired by the nuances protagonists of the latest seasons of fashion, and capable of embodying ideals of elegance and intense femininity.

Characteristics which forcefully emerge thanks to the extreme lightness of the metal frame design and to the careful distribution of weights that emphasizes a graceful silhouette rich in stylistic linearity; a result of a deep reinterpretation of classical volumes in a contemporary key.

A modern and up to date style dedicated to young and dynamic environments where plays of hues, brightness, and shades, are born from the combination between the purity of the **SWAROVSKI ELEMENTS** crystal pendants, with their geometrical and drop cut facets and the elegance of the **handmade tailored lampshades**, capable of diffusing a deeply suggestive and enthralling light.





0118B02
Ø 100 cm - H. 80 cm - kg 18
15 x E14 max 40 watt



0118B02
Ø 100 cm - H. 80 cm - kg 18
15 x E14 max 40 watt

Il fascino intenso di una notte che si tinge di nuance argentee ed atmosfere ricche di suggestione e raffinatezza: la collezione **Silver Night** è simbolo dell'identità di uno stile fortemente **ispirato a ideali di moderna eleganza, classe e decoro.**

Influenze stilistiche che nascono dal **vetro di Murano** con pregiata **finitura specchiata** in grado di creare affascinanti giochi di rifrazioni e di lucentezze grazie alle forme sinuose ed affusolate, interpretando la ricerca e lo studio sui volumi e sulle tendenze contemporanee.

Un carattere moderno ed estremamente marcato, accentuato dall'**illuminazione a doppia accensione con Led decorativi** che enfatizzano i ricercati effetti di luce creati dai paralumi, **rivestiti con nastri trasversali in raso di seta**, e dalle **coppe con elegante finitura fumè.**

SILVER NIGHT

The **Silver Night** lighting collection delivers the intense fascination of nighttimes tinged with the glitter of silver and atmospheres rich in meaning and refinement. The style of the collection is clearly **inspired by the modern ideals of elegance, class and decor.**

The design is clearly focused on precious, **mirror finished Murano glass** which creates fascinating effects of refraction and brilliance. Sinuous, streamlined forms offer a superb interpretation of contemporary trends and ideas in the use of volume.

The collection's highly distinctive and modern character is accentuated by **two level lighting and by decorative Leds.** The Leds emphasise the stylish effects created by **lamp shades finished in silk satin ribbons**, and by elegant, **smoke effect cups.**





0200B01
Ø 110 cm - H. 60 cm - kg 16
15 x G9 max 40 watt



0200B02
Ø 83 cm - H. 60 cm - kg 11
8 x G9 max 40 watt



0200B02
Ø 83 cm - H. 60 cm - kg 11
8 x G9 max 40 watt



0200B03
Ø 75 cm - H. 60 cm - kg 8
6 x G9 max 40 watt





0200B04
Ø 45 cm - H. 44 cm - kg 6
5 x G9 max 40 watt



0200A02
L. 40 cm - W. 28 cm - H. 40 cm - kg 5
3 x G9 max 40 watt



0200A03
L. 40 cm - W. 21 cm - H. 40 cm - kg 4
2 x G9 max 40 watt



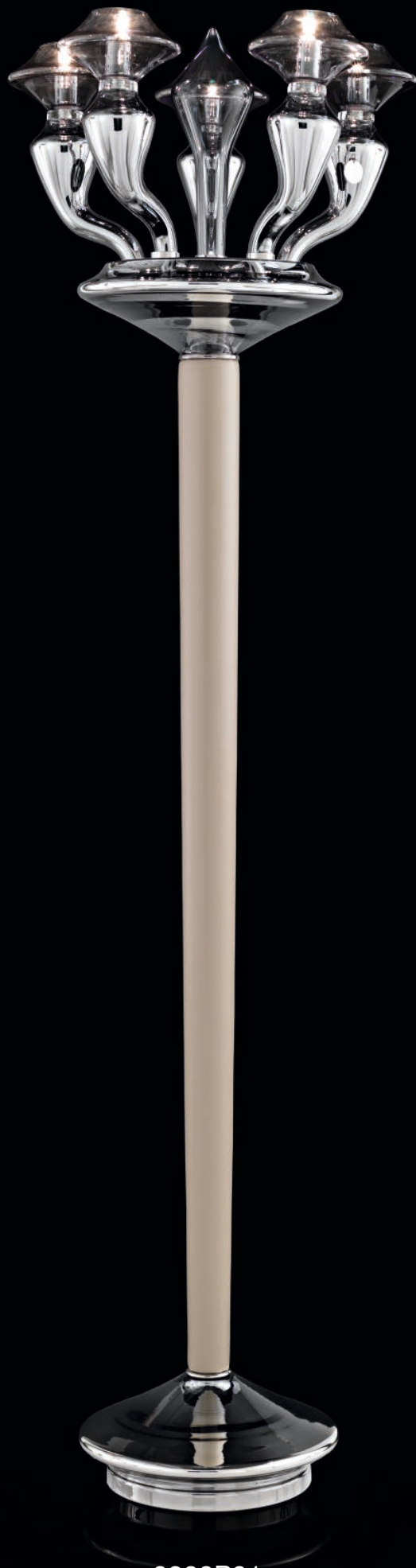

0200P01

Ø 45 cm - H. 162 cm - kg 18
5 x G9 max 40 watt



0200L01
Ø 42 cm - H. 108 cm - kg 6
1 x E27 max 60 watt



0200L02
Ø 22 cm - H. 48 cm - kg 2
1 x G9 max 40 watt

La collezione **Prestige** è ispirata a moderni ideali di eleganza e di stile, che nascono dal fascino ricercato dell'illuminazione decorativa di prestigio e ridisegnano dimensioni abitative glamour e contemporanee.

Caratteristiche rappresentate dal **telaio in metallo tagliato al laser**,
con elegante finitura al cromo o light gold,

che enfatizza la profonda pulizia stilistica del design e l'estrema ricercatezza nella progettazione dei particolari, ornamentali e di costruzione, sintetizzati dal nuovo **raffinato emblema Beby Italy** che incorona le creazioni, e dall'esclusivo sistema di montaggio manuale dei nuovi cristalli pendenti **SWAROVSKI ELEMENTS**.

Lampadario a sospensione, applique, piantana e lampada da tavolo, realizzate in coordinato, dotate di tecnologia a doppia accensione di **led e luci tecniche G9**, che sottolineano l'innata classe dei **paralumi in seta**, simbolo di un ideale di eleganza che fa della raffinatezza una chiave di lettura intramontabile e sempre fortemente attuale.

PRESTIGE

The **Prestige** collection is based on the modern ideals of elegance and style, inspired by the refined fascination of prestigious, artistic lighting. The Prestige collection adds glamour and modernity to any home. The collection is characterised by **laser-cut metal frames with an elegant chrome or light gold finish** that emphasise the stylish purity of the design and the true refinement of structural and decorative elements like the new **Beby Italy** logo that embellishes all the creations.

The Prestige collection also features

SWAROVSKI ELEMENTS pendants, hand assembled using a clever and exclusive system.

The hanging chandelier is complemented by matching applique, column and table lamps with two-level **lighting from LED and G9 halogen capsule lamps**. This refined lighting enhances the natural class of the silk lamp shades that symbolise a concept of elegance based on refinement as an age-old yet perpetually modern aesthetic.

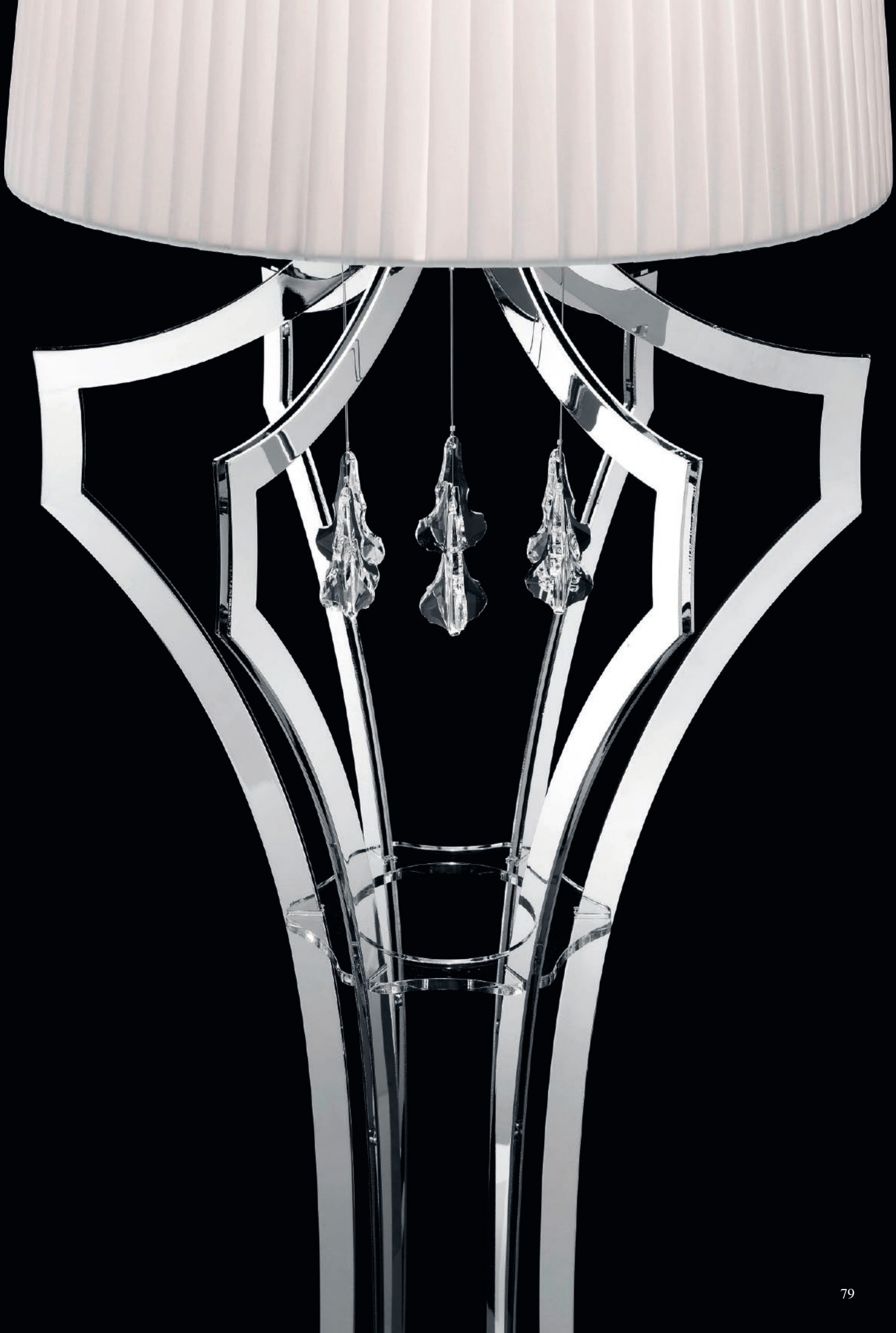



0180P01

Ø 42 cm - H. 184 cm - kg 18

1 x E27 max 60 watt + 1 LED 1,2 watt



0180B01

Ø 116 cm - H. 92 cm - kg 19

18 x G9 max 40 watt + 1 LED 1,2 watt + 1 LED 3,6 watt



0180B05

Ø 90 cm - H. 75 cm - kg 15

10 x G9 max 40 watt + 1 LED 1,2 watt + 1 LED 3,6 watt



0180B03

Ø 72 cm - H. 75 cm - kg 8,5

6 x G9 max 40 watt + 1 LED 1,2 watt + 1 LED 3,6 watt





0180A03

L. 18 cm - W. 15 cm - H. 60 cm - kg 2,5
1 x G9 max 40 watt



0180A01

L. 52 cm - W. 30 cm - H. 72 cm - kg 3,5
3 x G9 max 40 watt + 2 LED 1,2 watt



0180L01

Ø 32 cm - H. 85 cm - kg 4,6
1 x E27 max 60 watt + 1 LED 1,2 watt

Ispirato ai **colori caldi del tabacco ed a cangianti tramonti**, la collezione **Garden Party Antigua Rum** rievoca atmosfere e sapori lontani, ricchi di fascino e suggestione. Incredibili nuances che solo il vetro di Murano lavorato interamente a mano riesce a ricreare, impreziosite dai raffinati **SWAROVSKI ELEMENTS** pendenti nelle esclusive colorazioni abbinata.

Un simbolo della **maestria e del know how di Beby Italy**, che da oltre 50 anni incanta con inimitabili creazioni di luce ed emozione.

GARDEN PARTY ANTIGUA RUM

Inspired to the **warm colors of tobacco and to iridescent sunsets**, the **Garden Party Antigua Rum** collection evokes remote places and far away flavors, full of charm and suggestions. Incredible nuances that only the entirely hand-made Murano glass is capable of creating are made even more precious by the refined **SWAROVSKI ELEMENTS** pendants. A symbol of **Beby Italy's mastery and know-how** and its ability to enthrall with unequalled creations of light and emotion that has last for over 50 years.







7810BB3

Ø 135 cm - H. 104 cm - kg 100
12 x G9 max 40 watt + 1 LED 1,2 watt

La collezione **Vanité** è una raffinata manifestazione di concept stilistici ispirati a sofisticate visioni di **eleganza e femminilità**, simboleggiate da una sinuosa alternanza di **linee morbide ed ondulate** che sembrano riflettersi ed amplificarsi nel **vetro di Murano con effetto specchiato**.

Un portamento leggero enfatizzato da ricercate nuance cromatiche, che prendono vita nell'intenso contrasto generato dalla riflessione della luce sulla struttura, nelle velate trasparenze delle coppe e dei paralumi con lavorazione sartoriale a nastro. Un omaggio a nuovi ideali di bellezza, che ereditano tradizioni di immenso fascino e trasformano un'intrigante silhouette nell'eterno ed immobile istante di un incedere quasi regale verso nuove forme di vanità.

VANITÉ

The **Vanité** collection is a refined manifestation of stylistic concepts inspired by **sophisticated visions of elegance and femininity**. The collection is characterised by soft undulating lines that alternate sinuously and are reflected and amplified by **mirror effect Murano glass**. The lightweight appearance of these creations is enhanced by refined nuances of colour. These are created by light reflecting on the frame and generating intense contrasts, and by the veiled transparency of the cups and of the lamp shades with tailored ribbon finish.

The **Vanité** collection pays homage to new ideals in beauty, ideals that have inherited all the fascination of tradition but are still capable of transforming the intriguing silhouettes of these creations into timeless and unchanging instants in an almost regal trend towards new forms of exclusivity.





7710A01

L. 55 cm - W. 30 cm - H. 52 cm - kg 6
2 x G9 max 40 watt + 1 LED 1,2 watt



7710B01

Ø 125 cm - H. 70 cm - kg 25
15 x G9 max 40 watt + 1 LED 1,2 watt



7710P01

Ø 42 cm - H. 180 cm - kg 25
1 x E27 max 60 watt



7710L01

Ø 30 cm - H. 80 cm - kg 3

1 x E27 max 60 watt





7710B04

Ø 80 cm - H. 70 cm - kg 14
6 x G9 max 40 watt + 1 LED 1,2 watt

Simbolo ed **emblema della maestosità della luce** che regna sovrana grazie all'imponenza delle forme ed all'incredibile minuziosità dei particolari, la collezione **Queen of Roses** incarna l'esperienza e l'eredità di una tradizione e di una maestria artigianale centenaria.

La **struttura in metallo**, rivestito in **vetro di Murano**, disponibile in **diverse colorazioni e finiture** o con esclusiva **placcatura in oro 24 carati**, gli **SWAROVSKI ELEMENTS** incastonati sulla coppa centrale, la miriade di pendenti e catene ornamentali di cristalli, rappresentano la magnificenza che dà forma all'incomparabile **unicità di un'opera d'arte**.

Un tripudio di **luce, funzionale e scenica**, che si propaga inondando l'ambiente con iridescenze ed emozionanti sfumature generate dalle decorazioni con motivi floreali e dalla prestigiosa rosa centrale, una vera e propria scultura di grande valore artistico realizzata interamente a mano, che rappresenta il cuore e l'anima, unica, impareggiabile ed irripetibile, di ogni creazione.

QUEEN OF ROSES

As a symbol and **emblem of the majesty of light** that reigns supreme, thanks to the magnificence of shapes and unbelievable minuteness of details, **Queen of Roses** collection embodies the experience and heritage of a centenary tradition of craftsmanship and mastery.

The metal structure, coated in **Murano glass** and available in different colorations and finishings and in the exclusive **24-carat gold plated** finishing, the **SWAROVSKI ELEMENTS** inlaid on the central cup, the myriad of pendants and ornamental crystal chains: all this represents the magnificence that gives shapes to the incommensurable **uniqueness of a work of art**.

A jubilation of **light, both functional and scenic**, that spreads and immerses the environment in iridescence, and stirring hues, generated by the colorations with their floral motifs, and by the prestigious central rose, truly a sculpture of great artistic value, entirely handmade, representing the heart, and soul of every creation.







9000B18

Ø 135 cm - H. 140 cm - kg 130
36 x E14 max 40 watt + 5 LED 1,2 watt



9000A05

L. 56 cm - W. 38 cm - H. 70 cm - kg 8
5 x E14 max 40 watt + 3 LED 1,2 watt



9000B18

Ø 135 cm - H. 140 cm - kg 130
36 x E14 max 40 watt + 5 LED 1,2 watt



9000B06

Ø 76 cm - H. 86 cm - kg 25
6 x E14 max 40 watt + 6 LED 1,2 watt



9000B18

Ø 135 cm - H. 140 cm - kg 130
36 x E14 max 40 watt + 5 LED 1,2 watt





9000Q01
Ø 50 cm - H. 60 cm - kg 10
4 LED 3 watt



9000P01

Ø 76 cm - H. 186 cm - kg 55
6 x E14 max 40 watt + 7 LED 1,2 watt



9000B17

Ø 240 cm - H. 260 cm - kg 300

81 x E14 max 40 watt + 13 LED 1,2 watt



9000A05

L. 56 cm - W. 38 cm - H. 70 cm - kg 8
5 x E14 max 40 watt + 3 LED 1,2 watt



9000B19

Ø 180 cm - H. 260 cm - kg 250

63 x E14 max 40 watt + 18 LED 1,2 watt



9000A01

L. 56 cm - W. 38 cm - H. 70 cm - kg 6
3 x E14 max 40 watt + 3 LED 1,2 watt



9000B18

Ø 135 cm - H. 140 cm - kg 130
36 x E14 max 40 watt + 5 LED 1,2 watt



9000A01

L. 56 cm - W. 38 cm - H. 70 cm - kg 6
3 x E14 max 40 watt + 3 LED 1,2 watt



9000B21

Ø 200 cm - H. 140 cm - kg 230

54 x E14 max 40 watt + 15 LED 1,2 watt





9100B01

Ø 80 cm - H. 120 cm - kg 40
12 x E14 max 40 watt

La sontuosa maestosità delle creazioni **Masterpiece** e la raffinata minuziosità dei dettagli rivivono nella collezione **Beby Rose**, emblema di uno stile immortale che incontra la purezza e l'armonia di forme, linee e materiali di incommensurabile prestigio.

Una pioggia di luce che si arricchisce con l'**assoluta trasparenza e la luminosità** del **vetro di Murano**, degli **SWAROVSKI ELEMENTS** pendenti e delle sottili catene di cristalli che, insieme alle **coppe in vetro lavorato ed alle rose realizzate interamente a mano da maestri artigiani**, adornano l'imponente struttura come gioielli di altri tempi.

Elementi che conservano intatto il prestigio regale della classicità rendendolo al tempo stesso moderno ed attuale grazie alle ricercate nuance cromatiche ed all'eleganza dei paralumi in pregiati tessuti con effetti metallici e **sete con stampe floreali, confezionati artigianalmente** e rifiniti con eleganti nastri alla base, che trasmettono spiccati accenti glamour.

BEBY ROSE MASTERPIECE

The sumptuous majesty of a **Masterpiece** creation, with its refined meticulousness for details, revive in the collection **Beby Rose** as an emblem of an immortal style that merges the purity and harmony of forms, lines and materials of incommensurable value.

A rain of light enriched by the **absolute transparency and luminosity** of the **Murano glass**, by the **SWAROVSKI ELEMENTS** pendants, and by thin crystal chains that, together with the finely **worked glass cups and roses, entirely handmade by master artisans**, adorn the imposing structure just like jewels from another time.

Elements that preserve untouched the regal prestige of classical antiquity, and yet, render the creation modern and up to date thanks to the refined chromatic nuances, and to the elegant lampshades in precious fabrics, with metallic effects and **floral print silks**, which are **handmade tailored** and perfected with elegant ribbons at the base to transmit a pronounced glamour touch.







0130B11

Ø 180 cm - H. 260 cm - kg 170
56 x E14 max 40 watt + 10 LED 1,2 watt

La nuova collezione di plafoniere **Mademoiselle Corolle Ceiling Lamps**, è dedicata ad **ambienti con altezze contenute**, e nasce da elementi stilistici classici, floreali e di **ispirazione decò**, reinterpretati in chiave moderna, giovane e vivace.

La progettazione tecnica, interamente modulare, permette di **personalizzare le dimensioni** delle creazioni per adattarle alle specifiche esigenze abitative, trasformandole in soluzioni di illuminazione funzionali e stilisticamente inedite, decorate con roselline in **vetro colorato**, o **dischi in metallo galvanizzato** con emblema **Beby Italy** realizzato con taglio al laser.

Particolari ricchi di personalità che si completano grazie all'esclusiva tecnica di lavorazione del **vetro di Murano**, frutto degli studi sulla rifrazione della luce, che genera finiture granulari con affascinanti effetti chiaroscurali, velature ed intense, suggestive sfumature.

MADemoiselle COROLLE

This new collection of ceiling lamps, **Mademoiselle Corolle Ceiling Lamps**, is dedicated to **environments with limited height**; it develops out of classical stylistic elements, and is inspired by deco and floral motifs, but all in a modern, young, and vivacious reinterpretation.

The technical design, entirely modular, allows for a customization of all creations dimensions in order to adapt them to specific needs. This brings to life a lighting solution which is functional and stylistically original, with decoration of **colored glass roses** or **galvanized metal plates**, bearing the **Beby Italy** emblem realized by laser cutting.

Unique details rich of personality, accompanied by an exclusive technical workmanship, a result of studies carried on the refraction of light, which generates granulose finishing and fascinating sparkles, glazes, and intense, suggestive hues.





8000Q01
Ø 100 cm – H. 45 cm – kg 30
10 x E27 max 60 watt



8000Q02
Ø 180 cm - H. 80 cm – kg 180
30 x E27 max 60 watt





8010Q01
Ø 100 cm – H. 52 cm – kg 60
18 x G9 max 40 watt





8020Q01
Ø 60 cm – H. 38 cm – kg 25
6 x G9 max 40 watt

Private Projects di Beby Italy Since 1960 sono progetti esclusivi dedicati ad una clientela che ricerca il prestigio di **opere assolutamente uniche**, con il più alto livello di personalizzazione di ogni singolo elemento, che garantiscano il lusso del vero **“made to measure”**, nella più **completa riservatezza e nel massimo anonimato**.

Creazioni esclusive ed irripetibili studiate dall'ufficio stilistico direttamente insieme al cliente, progettate per esaudirne ogni richiesta ed esigenza, e realizzate artigianalmente con selezioni riservate dei migliori materiali preziosi, finiture speciali e tecnologie funzionali dedicate, per assicurare un livello qualitativo superiore e la più attenta cura di ogni singolo dettaglio.

PRIVATE PROJECTS

Beby Italy Since 1960's Private Projects are exclusive projects dedicated to customers seeking creations of absolute uniqueness, and marked by the highest level of customization in every single detail, to guarantee the luxury of a genuine **“made to measure”**, **while providing full discretion and complete anonymity**.

Exclusive and unrepeatable creations developed alongside with the customers by our style studio to fulfill all customer requests and needs, and handcrafted, using a selection of only the best precious materials, special finishings, and functional technologies, thus ensuring a higher level of quality, and an utmost concern for each single detail.



7600B01

90 x 90 cm – H. 250 cm – kg 75
25 x E27 max 60 watt + 8 LED 1,2 watt





7600B02
Ø110 cm - H.320 cm - kg 160
24 x E27 max 60 watt





2000B11

Ø 148 cm – H. 218 cm – kg 108

36 x E14 max 40 watt + 9 x E27 max 60 watt





2007B01

Ø 160 cm – H. 220 cm – kg 125

32 x E14 max 40 watt + 28 x E27 max 60 watt





2008B01

Ø 180 cm – H. 240 cm – kg 140

20 x E14 max 40 watt + 19 x E27 max 60 watt







DILUCE

LIVING DESIGN



DIADEMA pag. 146



BOUQUET pag. 160



STONE pag. 172

La collezione **Diadema** è pervasa da accenti e sfumature essenziali, nella **pulizia stilistica delle geometrie disegnate**, che si arricchiscono di ritmo e movimento grazie alla profonda dinamicità delle linee avvolgenti e sinuose. Uno stile votato a rigorosi ideali di modernità che si traduce in creazioni di illuminazione dal **design ergonomico**, in cui il **vetro di Murano specchiato** è percorso da affascinanti spirali ed impreziosito da **volumi ellittici che amplificano la leggerezza delle strutture e dei sottili elementi di sostegno**.

Chandelier e applique dotate di tecnologia a **doppia accensione** in grado di valorizzare l'energia e la forza del colore, coordinate con il tavolino e la chaise longue dalle linee tondeggianti, proposte in raffinate varianti cromatiche a contrasto per enfatizzare l'armonia delle tinte chiare e dei ricercati abbinamenti tono su tono.

DIADEMA

The **Diadema** collection is pervaded by an essential look and feel created by **clear-cut styling and geometrical design**, enriched by the rhythmical and dynamic movement imparted by enveloping, sinuous lines.

These **ergonomically designed lighting** creations are the result of rigorous modern styling. Their **mirror finished Murano glass** is traversed by fascinating spirals and embellished by **elliptical shapes that emphasise the lightness of the structure and its subtle supports**.

The chandelier and applique both incorporate **two level lighting technology** to emphasise the energy and power of the colours. The coordinated coffee table and chaise longue feature rounded lines and come in refined and contrasting colour variants that emphasise the harmony of light hues and refined tone on tone combinations.







5450B01

Ø 120 cm - H. 158 cm - kg 35
25 x G9 max 40 watt

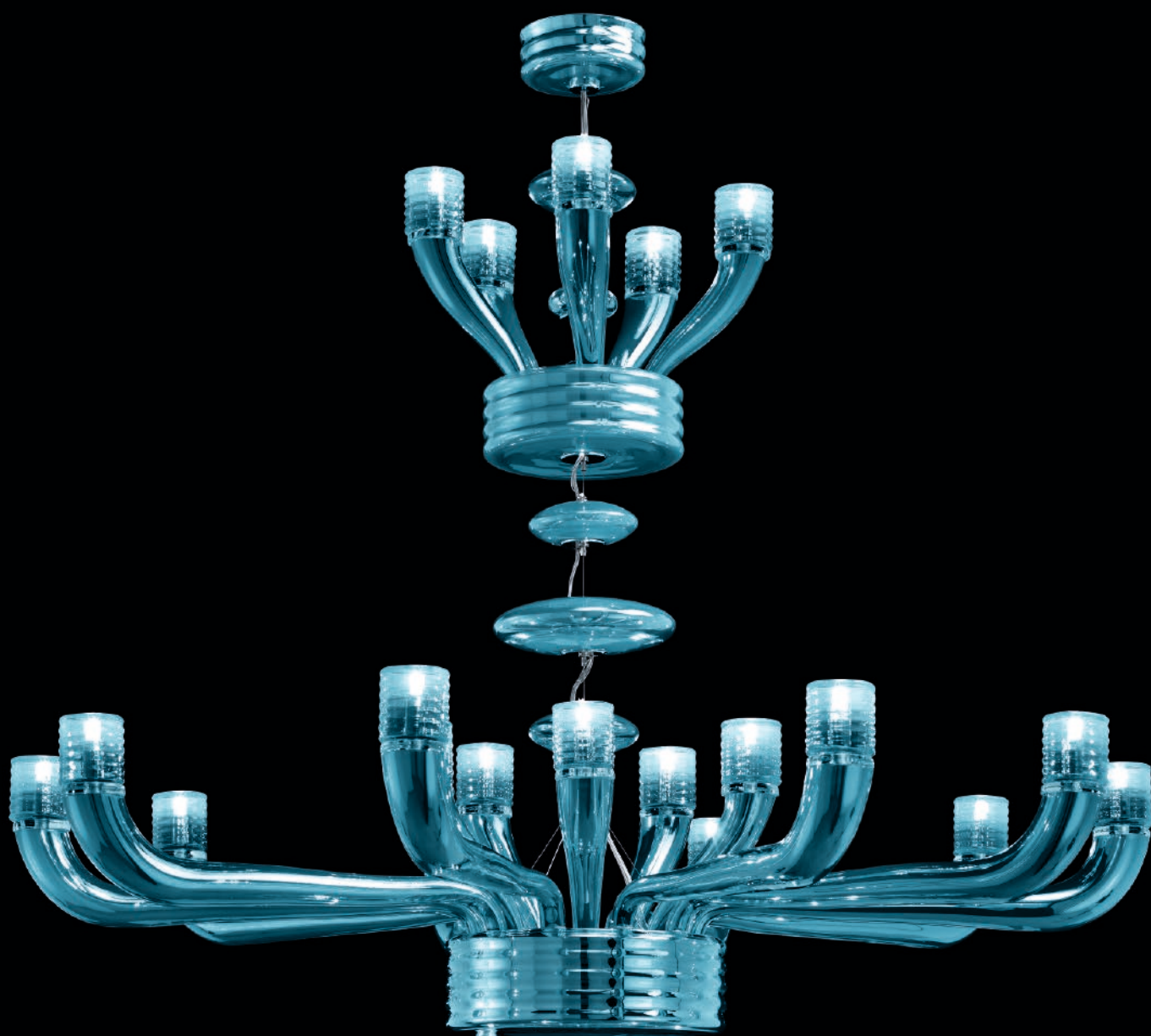

5450B06
Ø 120 cm - H. 125 cm - kg 30
20 x G9 max 40 watt

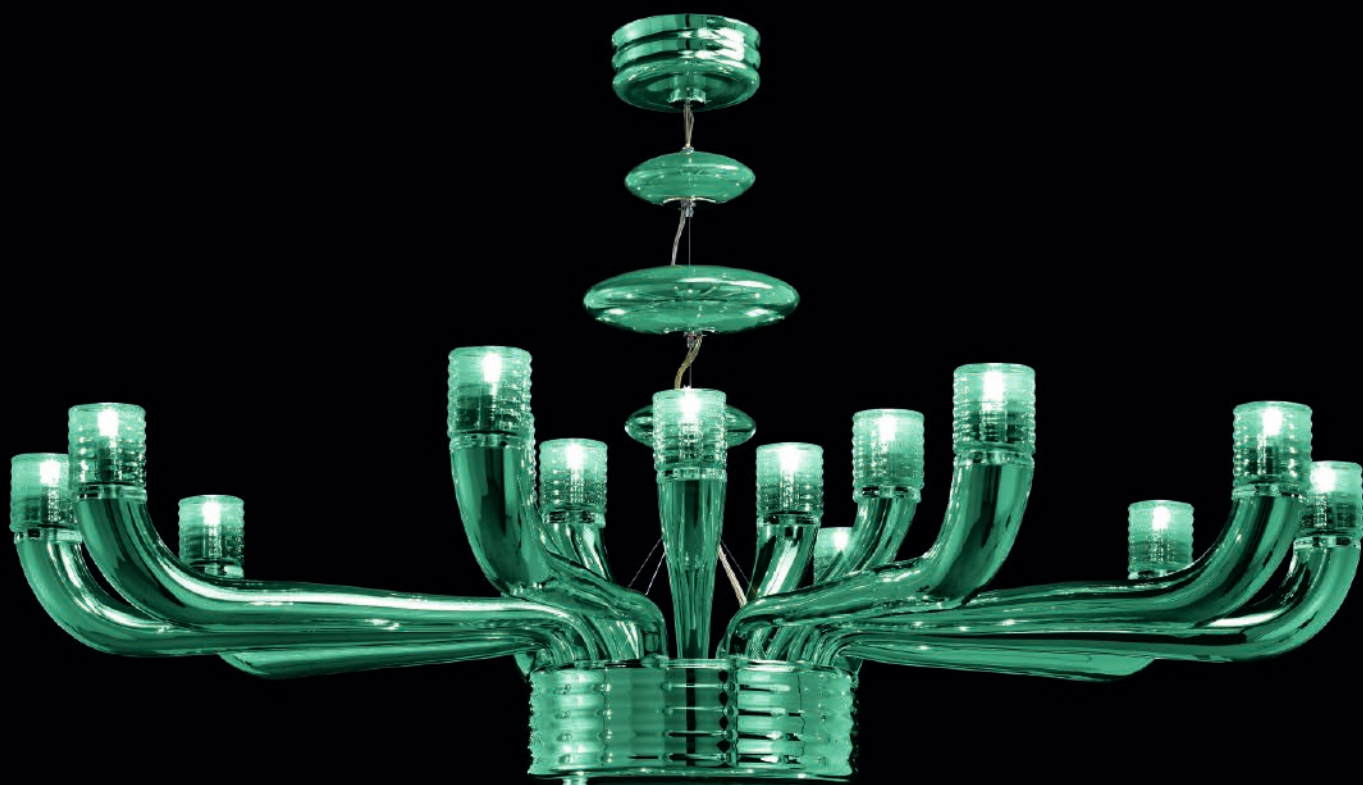

5450B07
Ø 120 cm - H. 73 cm - kg 20
15 x G9 max 40 watt



5450B02
Ø 80 cm - H. 64 cm - kg 15
8 x G9 max 40 watt



5450B08
Ø 80 cm - H. 64 cm - kg 12
6 x G9 max 40 watt

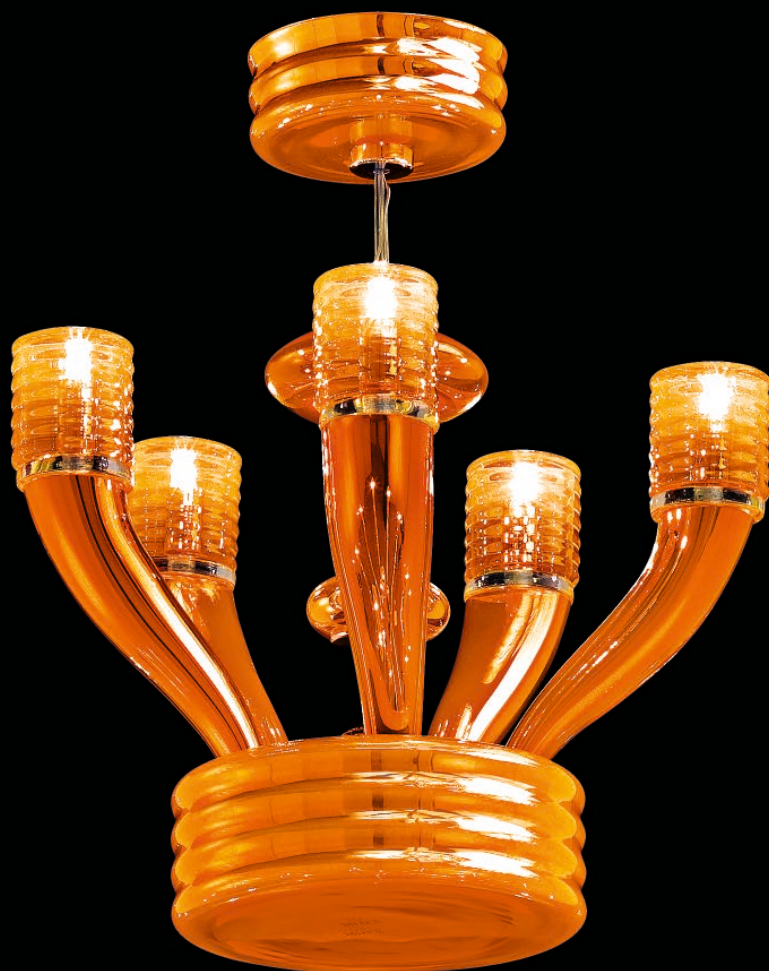

5450B09
Ø 42 cm - H. 51 cm - kg 8
5 x G9 max 40 watt

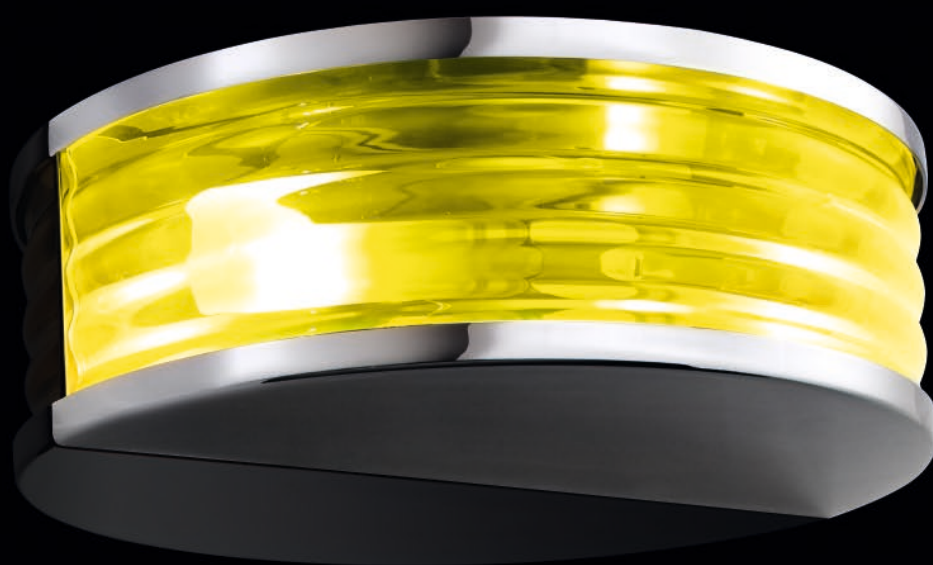

5450A01
L. 30 cm - W. 15 cm - H. 10 cm - kg 2
2 x G9 max 25 watt





5450L03
Ø 30 cm - H. 42 cm - kg. 2
1 x G9 max 40 watt



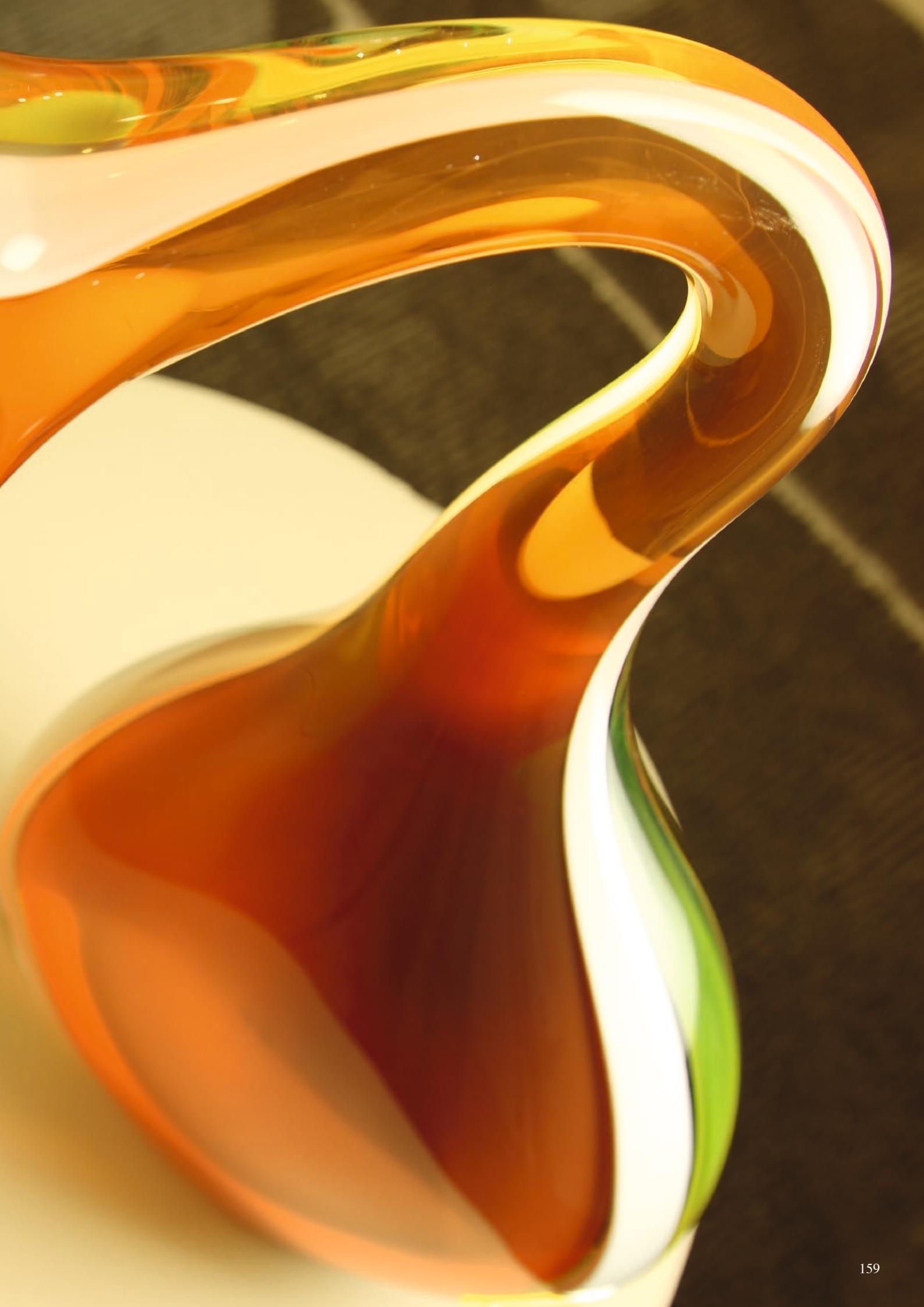

Ispirata alla perfetta simmetria della natura, la collezione **Bouquet** simboleggia la **rinascita della bellezza** che sboccia attraverso forme armoniose che si schiudono con grazia ed eleganza in atmosfere ricche di luce, ordine ed equilibrio.

Linee avvolgenti che accentuano il carattere moderno della **struttura in metallo**, disponibile in un **ampia gamma di colori e finiture**, impreziosita dalle catene con **SWAROVSKI ELEMENTS a cascata**, che fioriscono dal sinuoso corpo centrale a corolla trasmettendo intense sensazioni di movimento e dinamicità. Foglie e perle di cristallo che creano vivaci riflessi grazie al sistema di **illuminazione con luce tecnica, funzionale e decorativa**, che si riflette sulle superfici lucide e diventa elemento di **suggestione scenografica**, svelando l'attenzione per la ricerca stilistica e per una progettazione razionale ispirata a concetti di armonia, proporzione ed assoluta simmetria.

BOUQUET

Inspired by the perfect symmetry of nature, the **Bouquet** collection symbolizes the **reawaking of beauty** that blooms in harmonious forms, unfolds with grace, and creates atmospheres of intense light, order, and equilibrium.

Enveloping lines accentuate the modern character of the **metal frame** that, while being available in a **wide range of colors and finishings**, is made even more precious by the cascade of **SWAROVSKI ELEMENTS** chains blooming out of the petal shaped, sinuous central frame, conveying sensations of movement and dynamism. Crystal leaves and pearls that create lively reflections thanks to a system of **illumination which is technical, functional, and decorative**, reflecting on glossy surfaces to become an element of **scenic suggestion**, thus revealing the attention to stylistic research and rational design inspired by a conception of harmony, proportion, and absolute symmetry.



Deep





5200Q02
Ø 180 cm - H. 170 cm - kg 190
10 x E27 max 75 watt



5200B11
Ø 57 cm - H. 103 cm - kg 25
10 x G9 max 25 watt



5200B10

Ø 40 cm - H. 80 cm - kg 17

9 x G9 max 25 watt





5200B10
Ø 40 cm - H. 80 cm - kg 17
9 x G9 max 25 watt





5200A04

L. 39 cm - W. 20 cm - H. 80 cm - kg 13
5 x G9 max 25 watt



5200F01
Ø 12 cm - H. 9 cm - kg 1,5
1 GU10 max 50 watt



5200L01
Ø 30 cm - H. 45 cm - kg 6
1 E27 max 100 watt

Ispirata ai tagli ed alle forme geometriche delle pietre preziose, la collezione **Stone** è contraddistinta da un carattere **moderno ed essenziale**, generato dal sapiente abbinamento a contrasto tra **linee rette e curve**, tra sfaccettature marcate e forme arrotondate, che restituiscono affascinanti sensazioni di ritmo ed alternanza fortemente contemporanee.

Uno stile originato dalla ricercata dicotomia tra la struttura e la fascia in acciaio, con **logo DL e Stone**, gli inserti in vetro molato ed i cristalli **SWAROVSKI ELEMENTS** che amplificano ed armonizzano la rifrazione dell'illuminazione a **doppia accensione con led abbinati a luci tecniche G9 o a soluzioni a bassa tensione**, che garantiscono la giusta attenzione al risparmio energetico.

La collezione **Stone** è composta da sospensioni, applique e lampade da tavolo, disponibili in diverse dimensioni, che integrano i modelli di piantana e plafoniera, per offrire proposte complete e coordinate in grado di caratterizzare in modo unico, con la forza, l'intensità ed il gusto del design, ogni ambiente.

STONE

The **Stone** collection is inspired by the cuts and **geometric shapes of precious stones**.

The collection stands out for its modern, essential character, expressed by clever, contrasting **combinations of straight and curved lines**, distinctive facets and rounded forms that create a fascinating sensation of rhythmic, contemporary alternation. The design is characterised by the refined contrast between the frame and the steel fascia, with **DL and Stone logos**.

Ground glass inserts and **SWAROVSKI ELEMENTS** crystals amplify and harmonise the **refractions of the two-level lighting from LED and G9 halogen capsule lamps or other low consumption solutions chosen** to pay rightful homage to the cause of energy saving.

The **Stone** collection comprises hanging chandeliers, applique and table lamps in different sizes, as well as column lamps and ceiling lights. The collection can therefore offer complete and fully coordinated solutions capable of adding character, identity, and intense but tasteful style to any room.





5150Q01

Ø 80 cm - H. 29 cm - kg 25
6 x G9 max 40 watt + 1 LED 1,2 watt



5150E01

Ø 80 cm - H. 47 cm - kg 35
6 x G9 max 40 watt + 2 LED 1,2 watt



5150P01

L. 132 cm - W. 59 cm - H. 180 cm - kg 55
1 x E27 max 60 watt



5150L01
Ø 21 cm - H. 86 cm - kg 9
1 x E27 max 60 watt





5150A02

L. 40 cm - W. 22 cm - H. 27 cm - kg 6,5
2 x G9 max 40 watt + 2 LED 1,2 watt

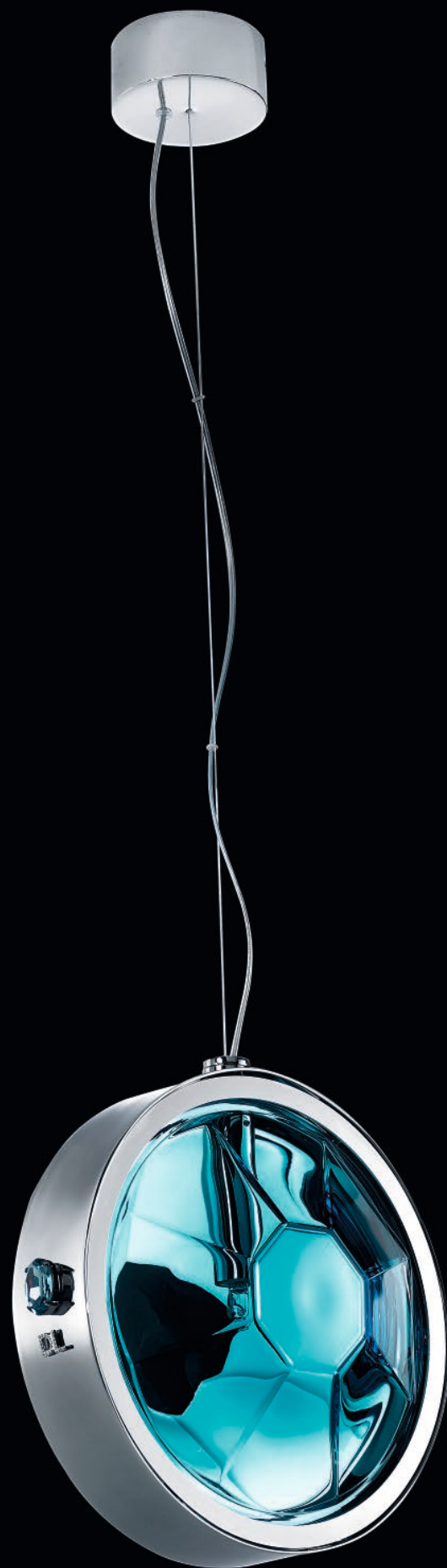

5150E03

L. 26 cm - W. 13 cm - H. 27 cm - kg 3,5

1 x G9 max 40 watt



5150A01
Ø 26 cm - H. 10 cm - kg 3
1 x G9 max 40 watt



5150L02
L. 19 cm - W. 16 cm - H. 40 cm - kg 3
1 x R7S max 60 watt



5150L03
L. 20 cm - W. 16 cm - H. 46 cm - kg 3
1 x G9 max 40 watt



COLOUR CARDS



MISS BIJOUX 0117

SW ROSALINE



203 light rose



208 rose



210 indian pink



268 fuxia

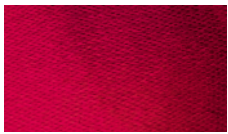

264 burgundy



324 red



204 light red



SW RED MAGMA

SW TOPAZ

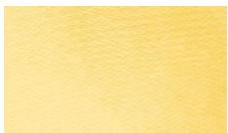

217 citrine



220 sun flower

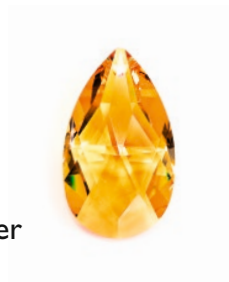

SW BRONZE SHADE

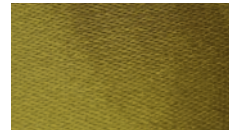

260 olive



299 fern green



305 dark green



307 green



311 emerald



SW GOLDEN TEAK



247 mocca



214 tabac



249 golden teak



304 golden shadow



213 rose shadow

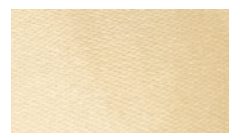

212 champagne



MISS BIJOUX 0117

SW BLUVIOLET

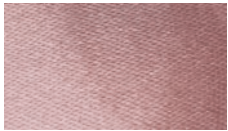

335 vintage rose



302 provence lavender



232 light amethyst



231 purple velvet



331 blue violet

SW BLUINO



262 light sapphire



318 capri blue



SW BLUE SHADE



224 cobalt



225 blue



SW SILVER NIGHT SW JET

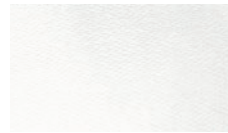

white



316 grey



black



MON TRESOR 0126



light gold - 1



white - 624



beige - 413



tortora - 414



vintage rose - 666

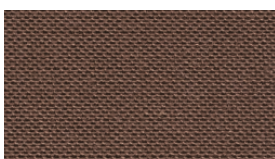

brown - MS



black - 920

PONGÉ



024 seta



041 champagne



017 rose



057 vintage rose

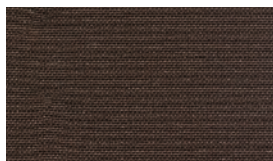

146 brown



058 azurine



063 grey

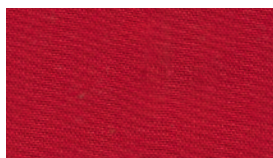

124 red



000 black

METALLIC FINISHES



chrome



light gold



gold



rosé

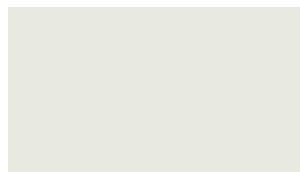

white pearled

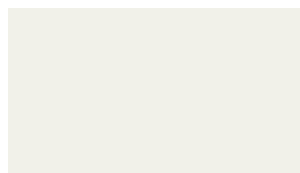

white leather 01

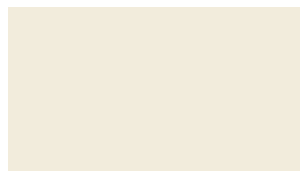

white silk 02



black

GLASS



TECHNICAL DETAILS

IMPORTANTE/IMPORTANT:

Le altezze indicate nelle specifiche tecniche dei lampadari si riferiscono alle dimensioni dei soli corpi illuminanti, senza catena e coprifilo, disponibili in lunghezze personalizzabili.

Per la massima fedeltà cromatica delle nuance dei tessuti e dei paralumi, si prega di fare riferimento esclusivamente all'apposita cartella colori realizzata con i tessuti utilizzati.

Le finiture dei metalli indicate con i termini Gold e Light Gold sono realizzate tramite procedimenti di placcatura che utilizzano esclusivamente oro a 24 Kt.

The heights indicated in the specifications for chandelier refer to the dimensions of the lighting only. They do not include the chain and canopy, available in customised lengths.

To ensure maximum fidelity to the colours and nuances of our fabrics and lamps shades, please refer exclusively to the colour samples book which contains the actual fabrics used.

The metal finishes indicated with the terms Gold and Light Gold are created by plating processes and use exclusively 24 Kt. gold.



CRYSTAL RAIN 0230

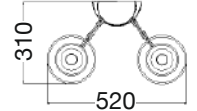
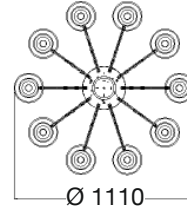
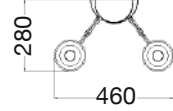
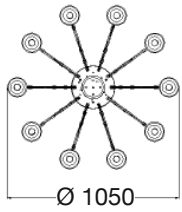
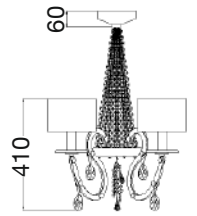
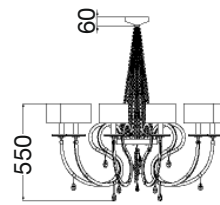
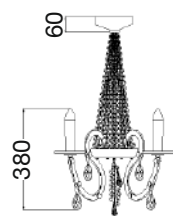
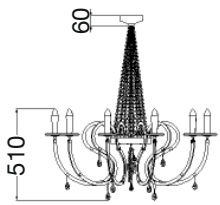

0230B01

0230A01

0230B02

0230A02

PRINCESS 9010

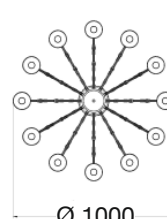
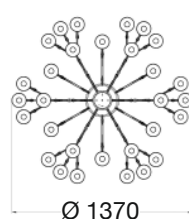
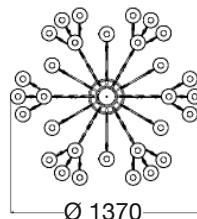
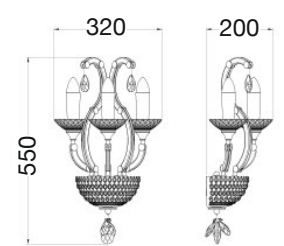
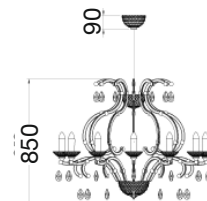
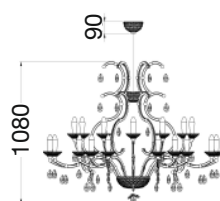
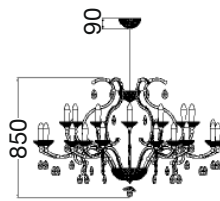

9010B04

9010B01

9010B02

9010A01

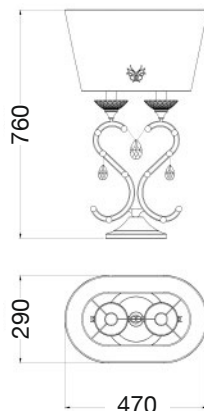

9010L02

9010L01

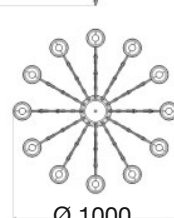
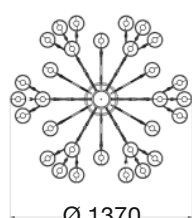
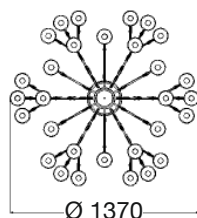
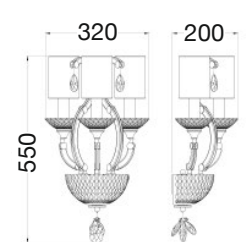
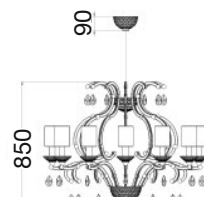
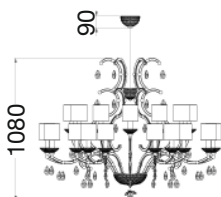
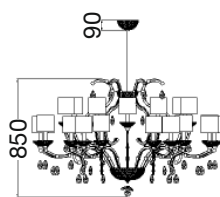

9010B04

9010B01

9010B02

9010A01

MON TRESOR 0126

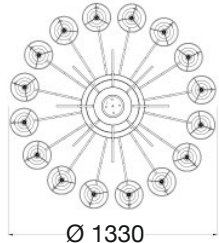
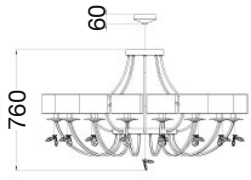

0126B07

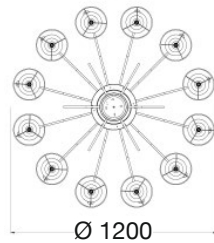
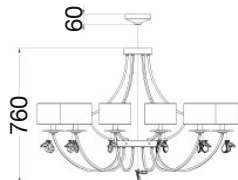

0126B04

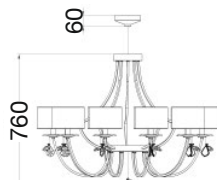

0126B03

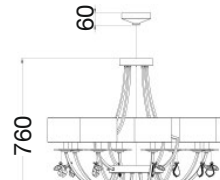

0126B02

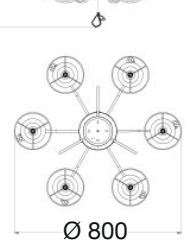
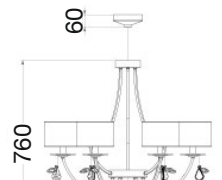

0126B01

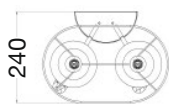
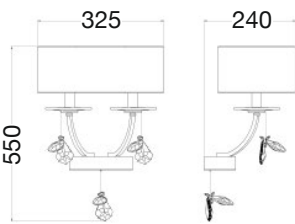

0126A02

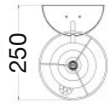
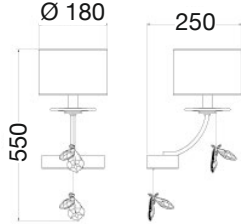

0126A01

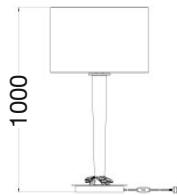

0126L02

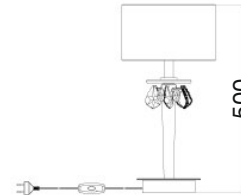

0126L01

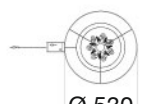
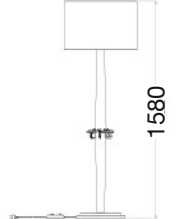

0126P01

MISS BIJOUX 0117

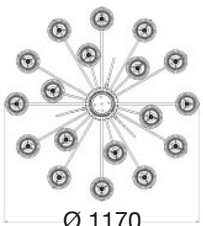
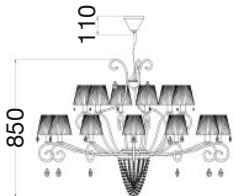

0117B05

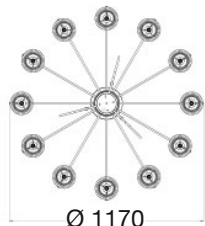
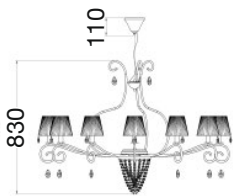

0117B04

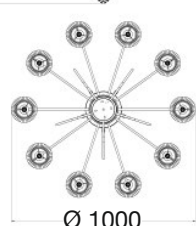
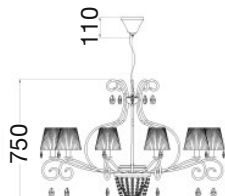

0117B03

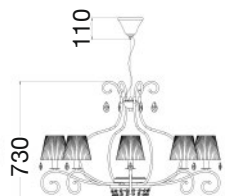

0117B02

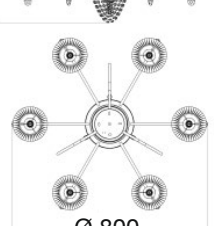
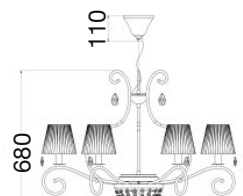

0117B01

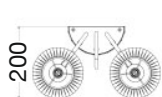
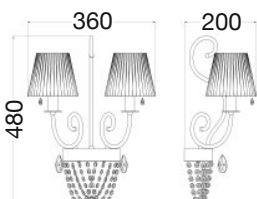

0117A02

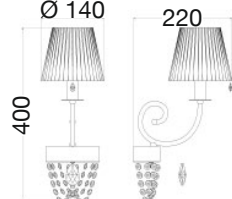

0117A01



0117P01

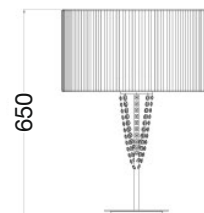

0117L01

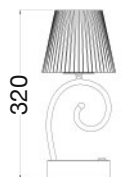

0117L02

PRIVILEGE 0240

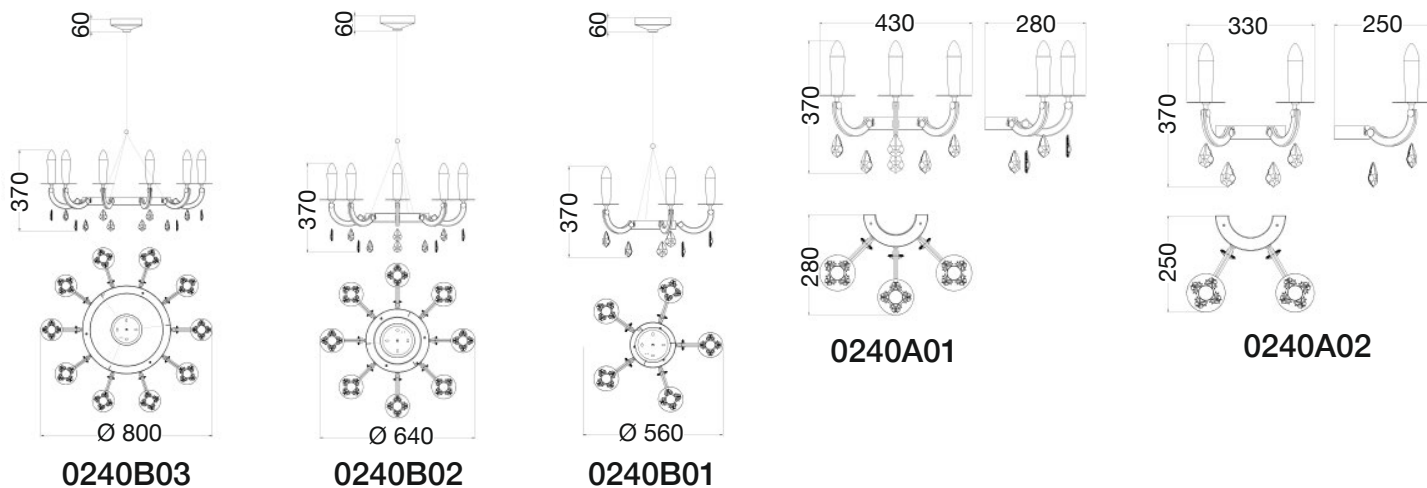

PRIVÉ 0210 - 0215- 0220

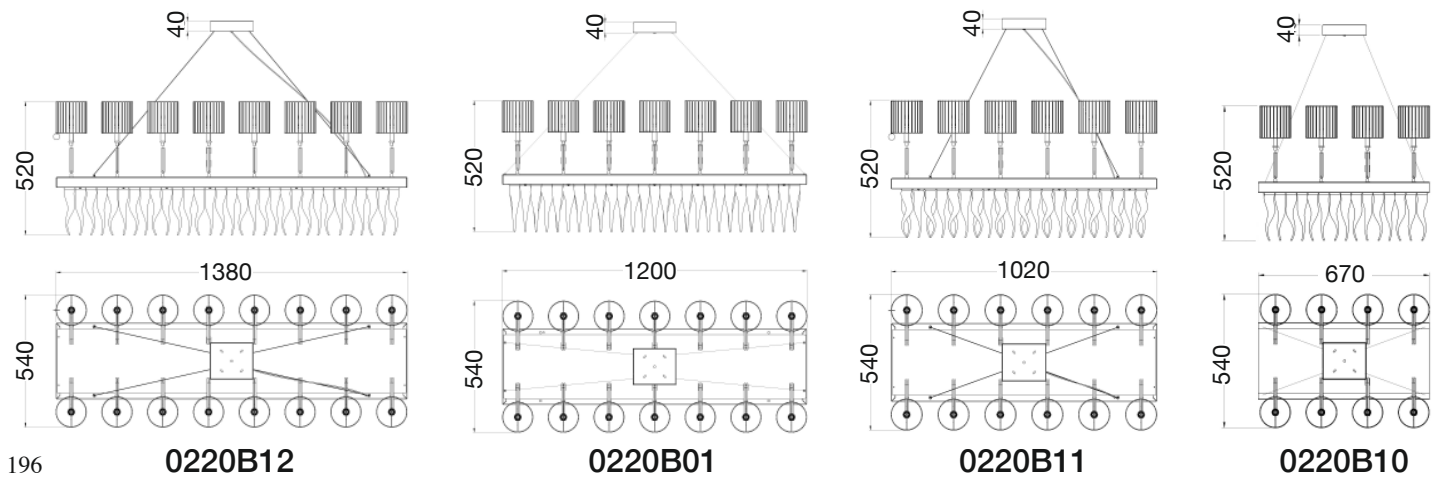
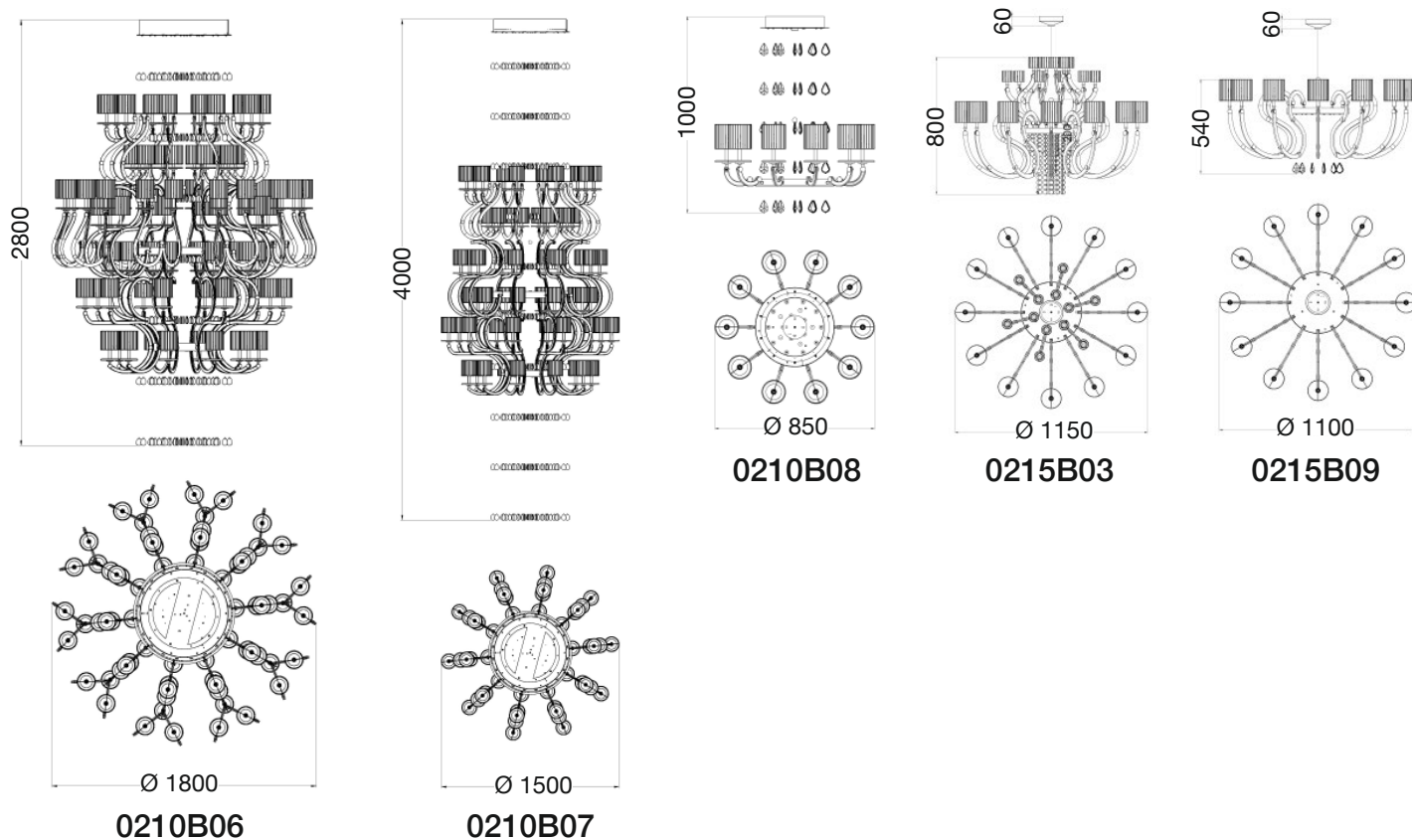

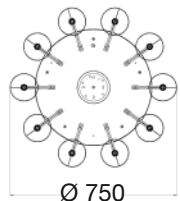
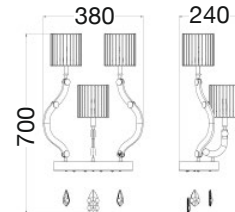
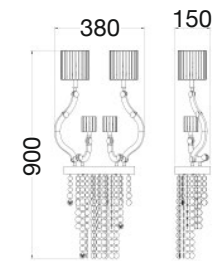
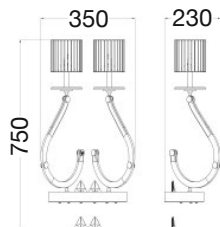
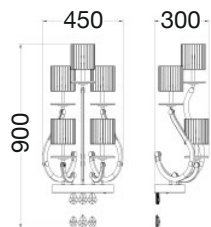
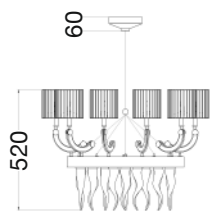

0220B04

0210A04

0210A05

0215A03

0215A06

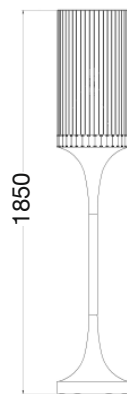
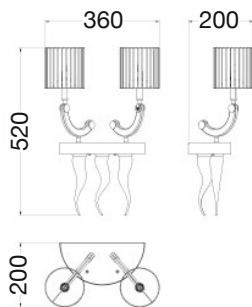

0220A02

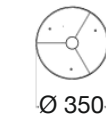

0210P01

VIOLET 0118

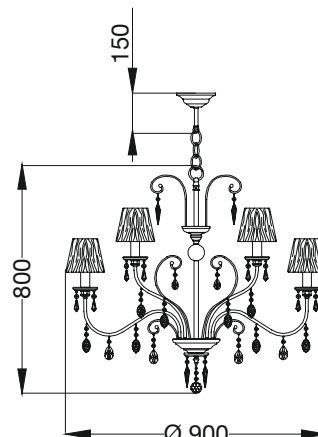
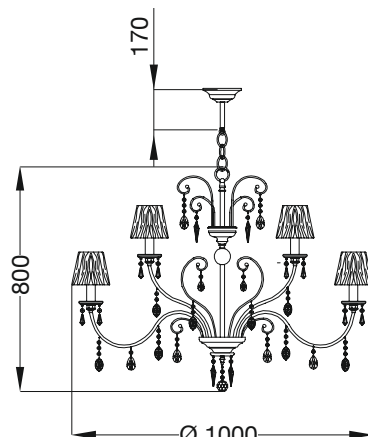
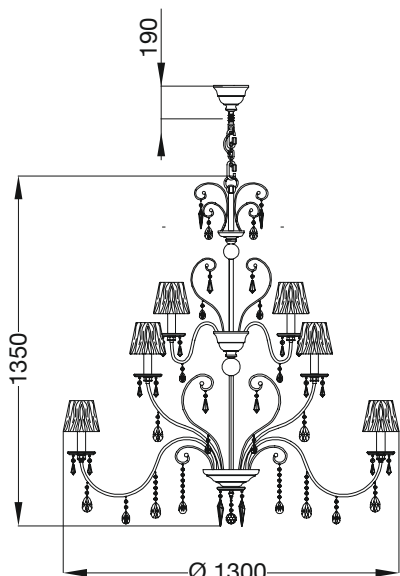

0118B07

0118B02

0118B03

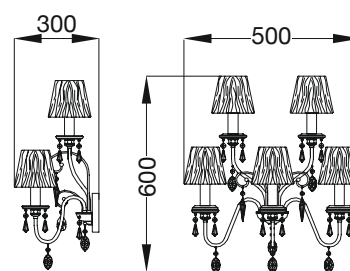
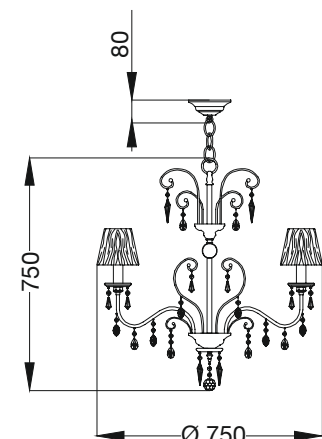
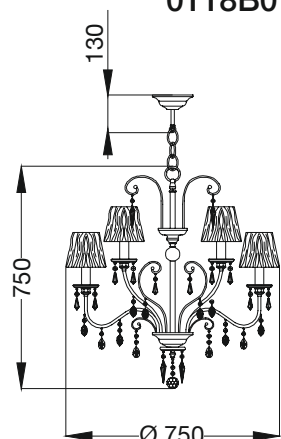

0118B04

0118B05

0118A03

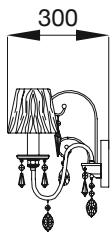

0118A02

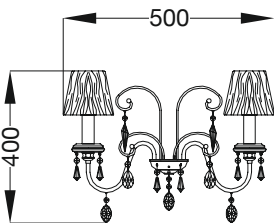

0118A01

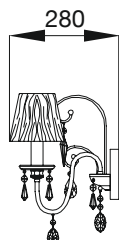

0118L02

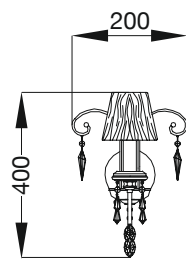

0118L01

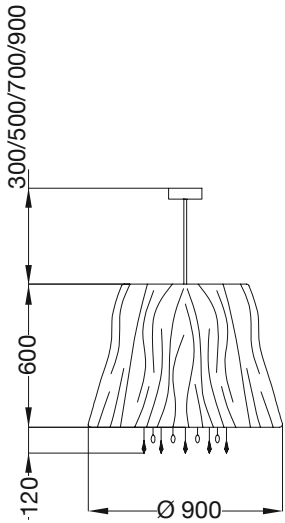
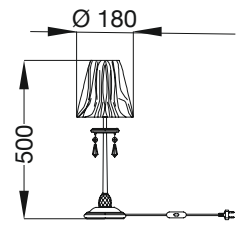
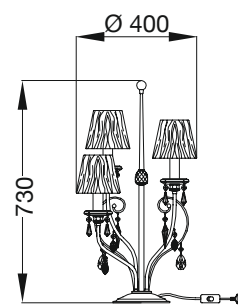

0118B10

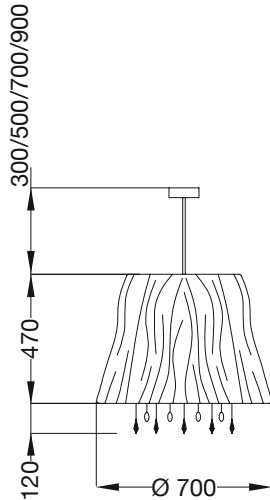

0118B09

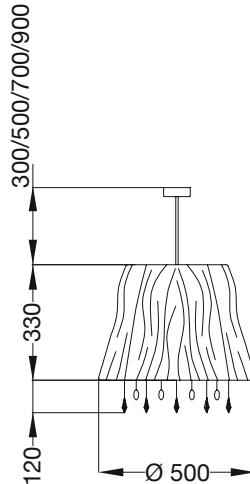

0118B08

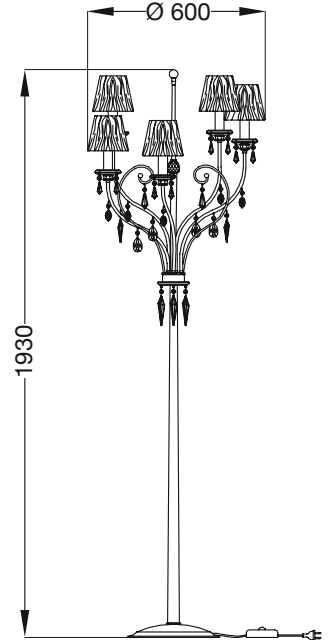

0118P01

SILVER NIGHT 0200

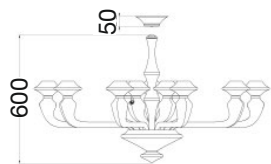

0200B01

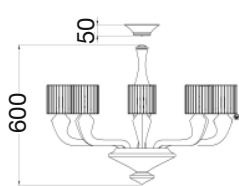

0200B02

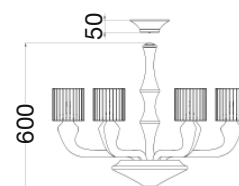

0200B03

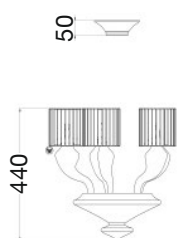

0200B04

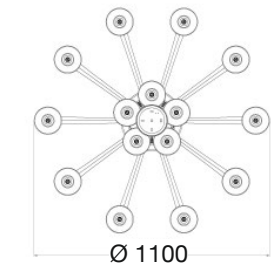

0200A03

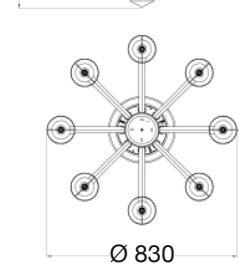

0200A02

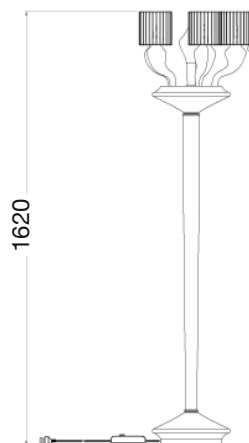

0200P01

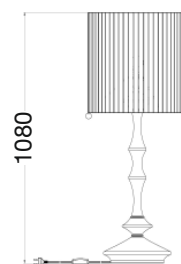

0200L01

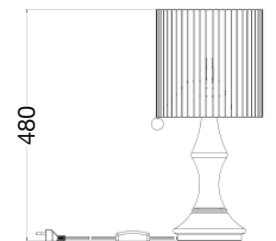

0200L02

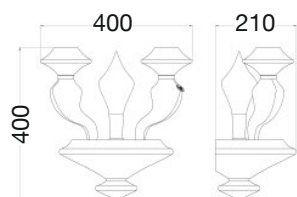

PRESTIGE 0180

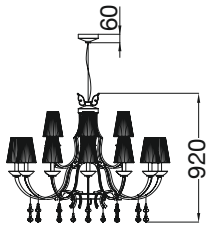

0180B01

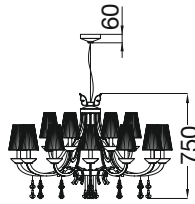

0180B09

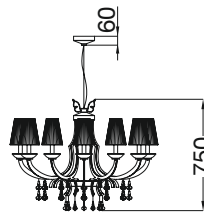

0180B06

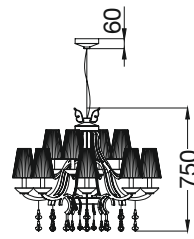

0180B08

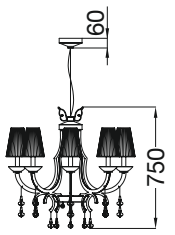

0180B04

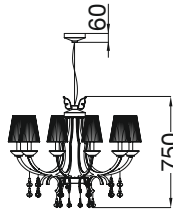
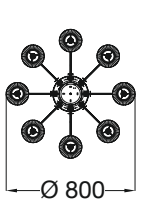
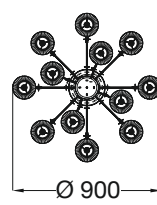
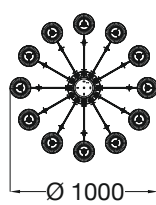
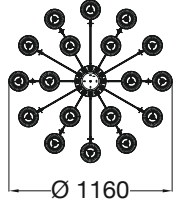
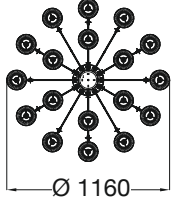

0180B05

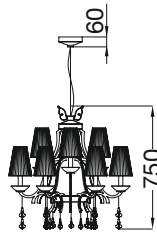

0180B07

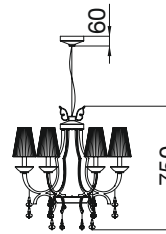

0180B03

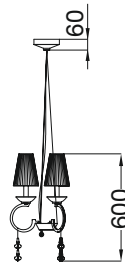

0180B02

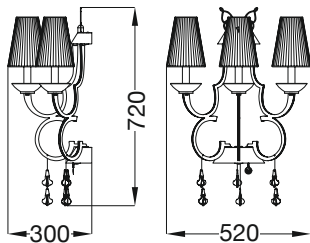
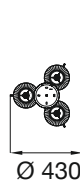
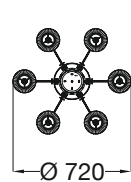
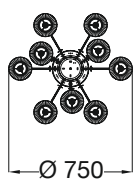
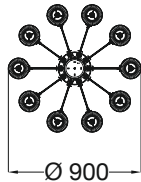

0180A01

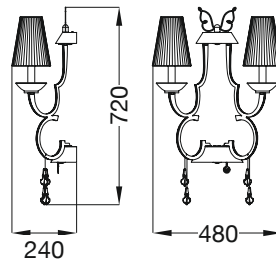

0180A02

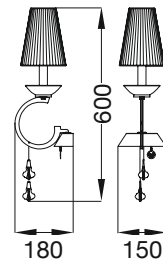

0180A03

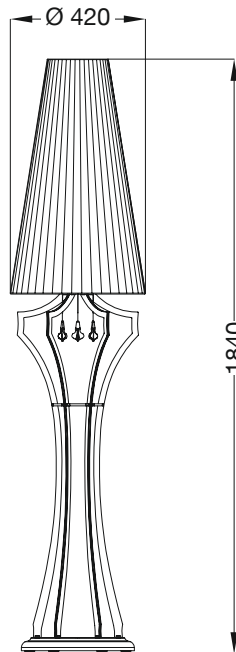

0180P01

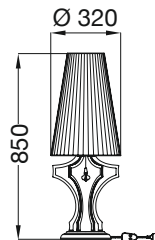

0180L01

GARDEN PARTY 7810

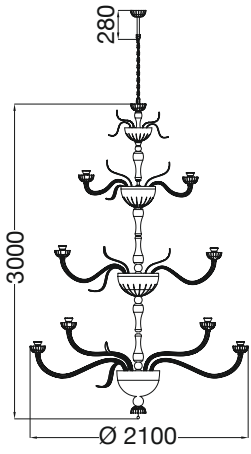

7810BA6

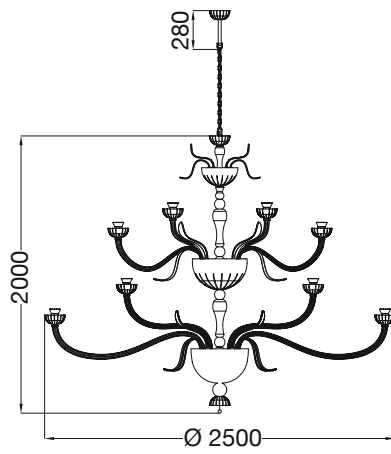

7810BA7

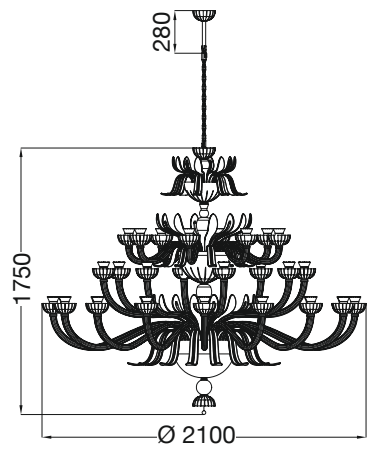

7810BA5

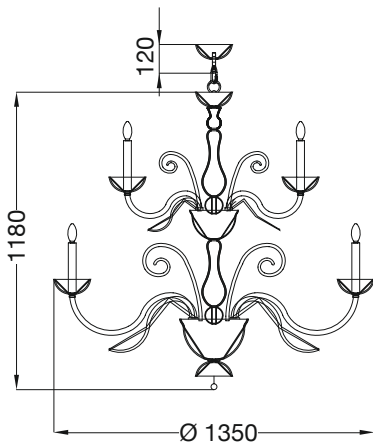

7800B01

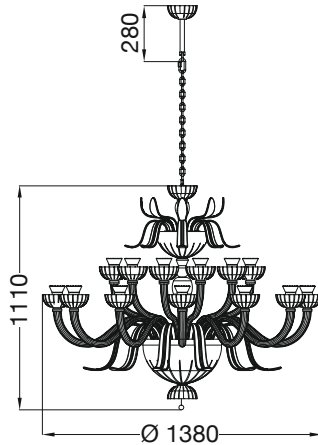

7810BB4

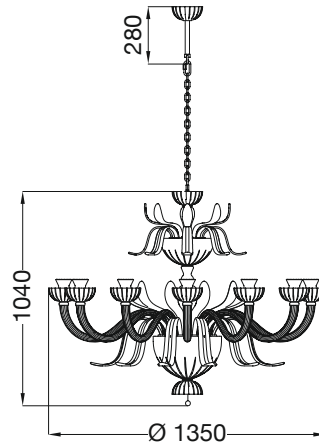

7810BB3

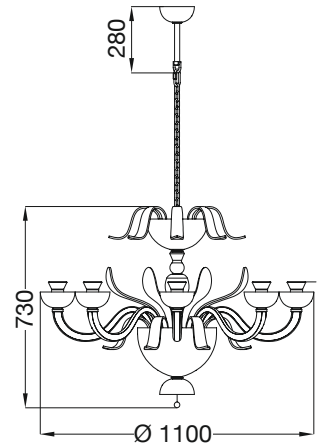

7810B02

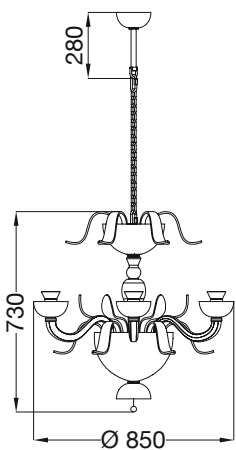

7810B01

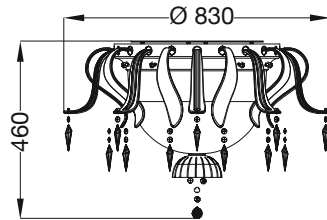

7810Q01

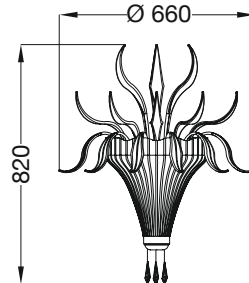

7810A01

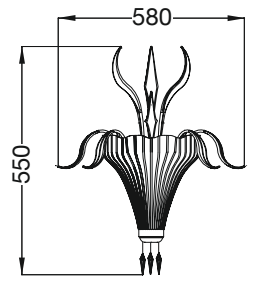

7810A02

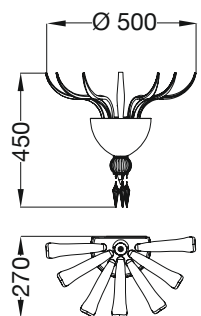

7810A03

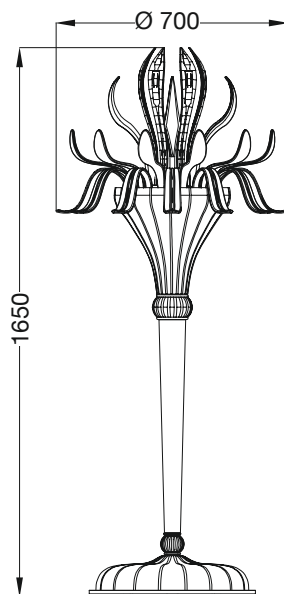

7810P01

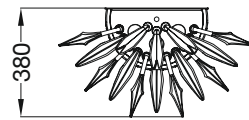

7810A01



7810A02

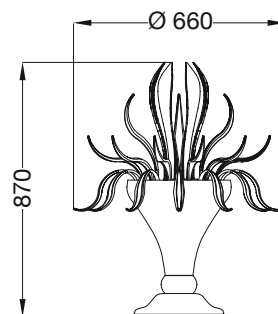

7810L02

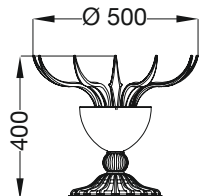

7810L03

VANITÉ 7710

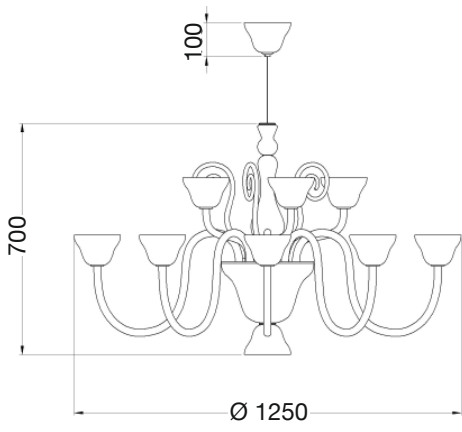

7710B01

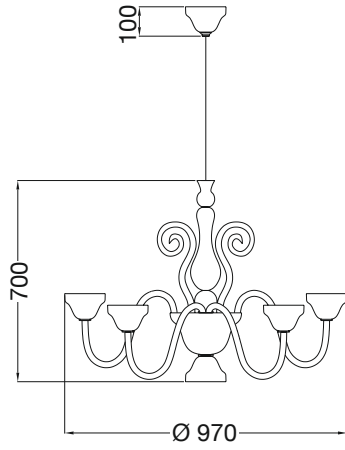

7710B03

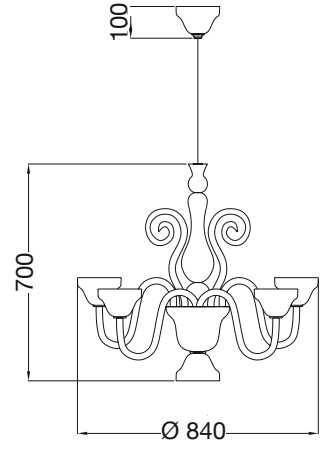

7710B02

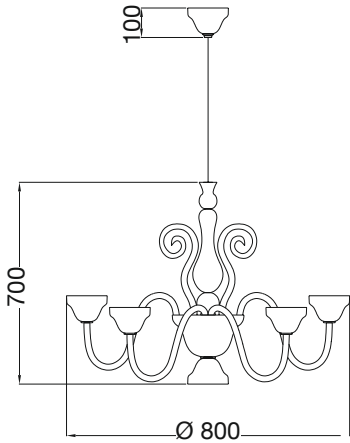

7710B04

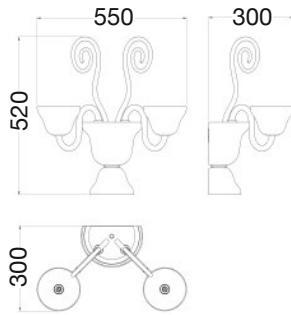

7710A01

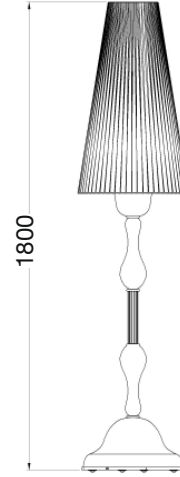

7710P01

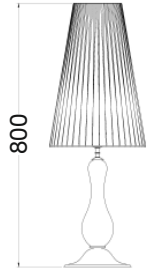

7710L01

QUEEN OF ROSES 9000

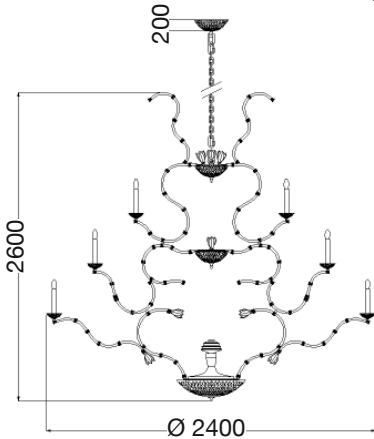

9000B17

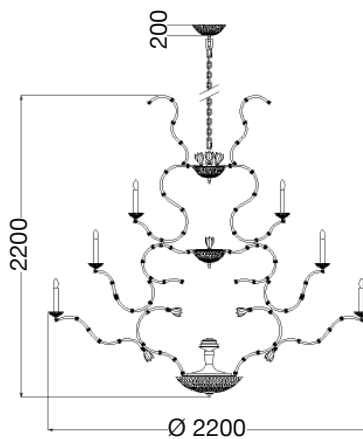

9000B20

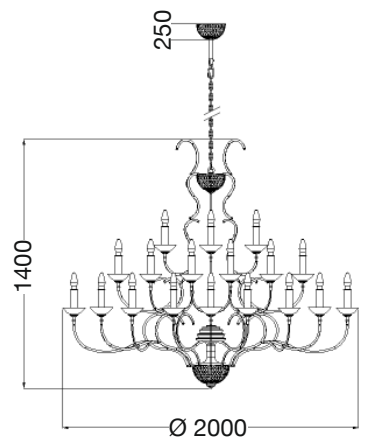

9000B21

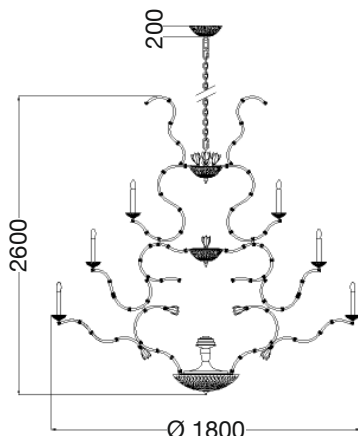

9000B19

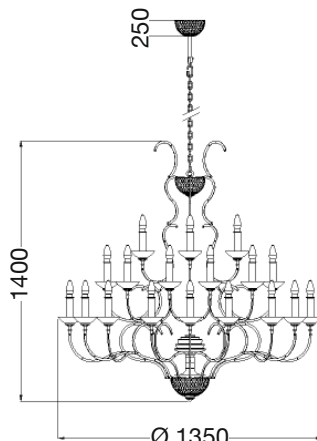

9000B18

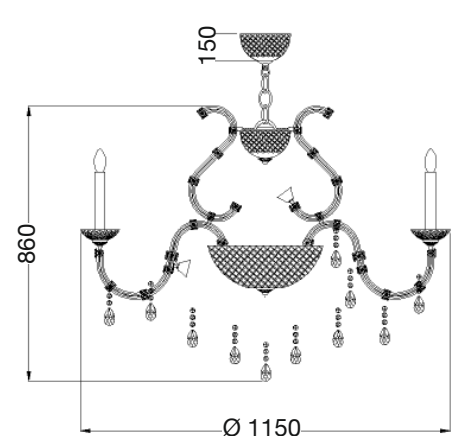

9000B07

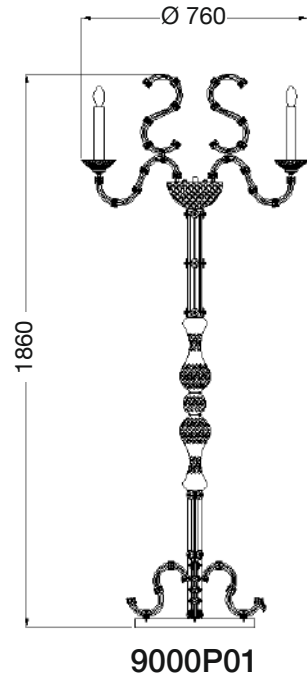
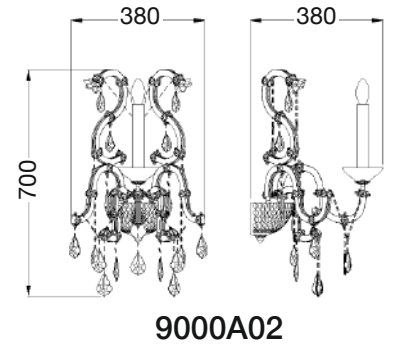
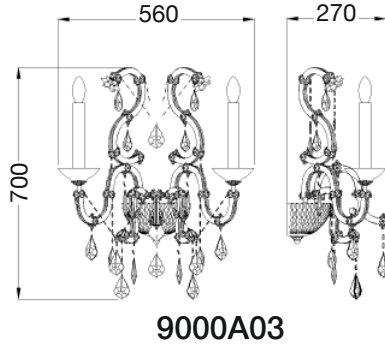
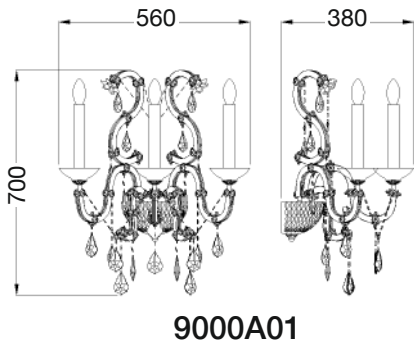
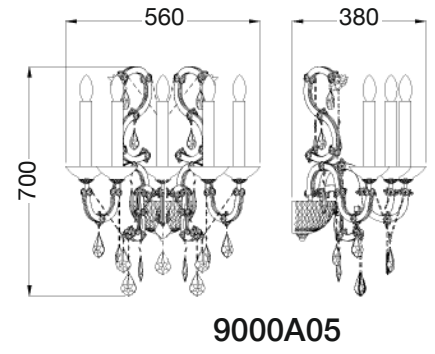
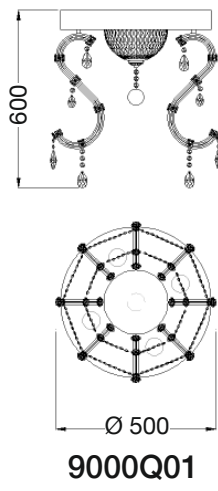
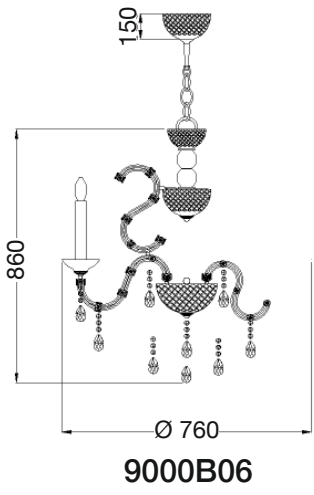

BEBY ROSE 0130

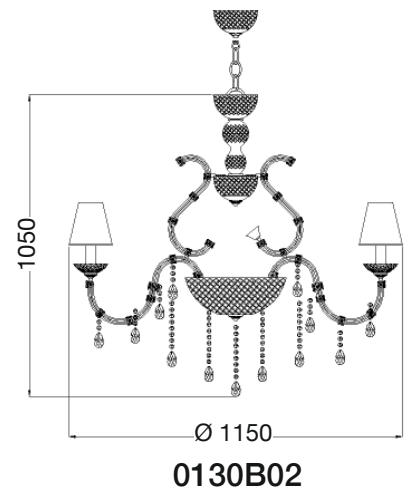
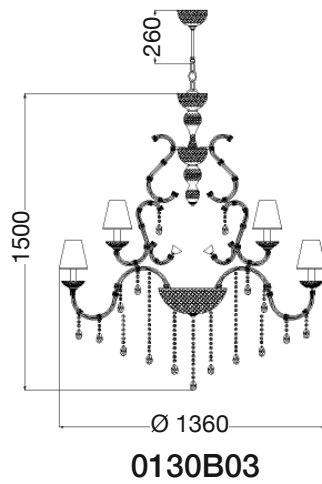
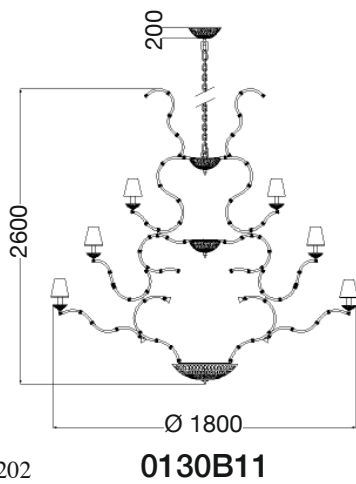

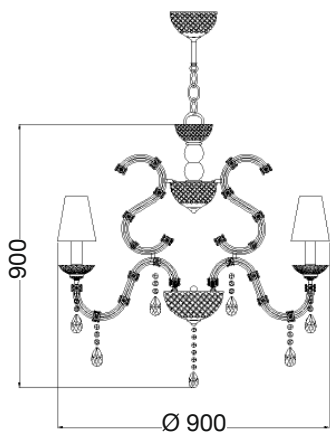

0130B07

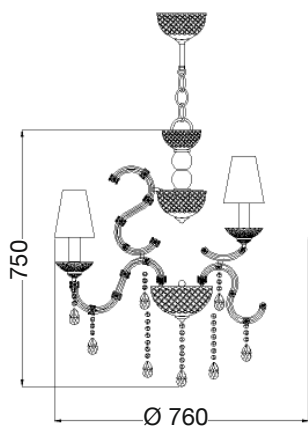

0130B01

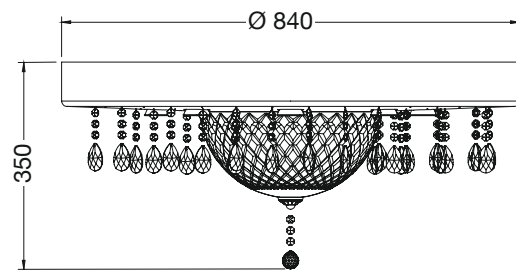

0130Q01

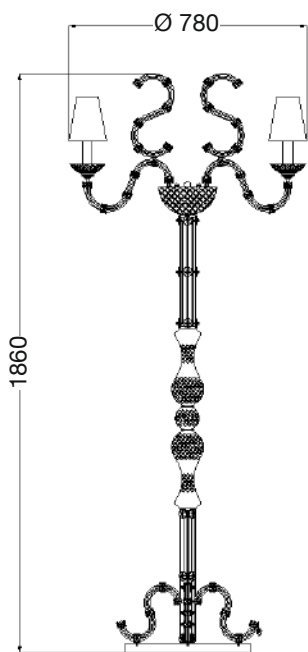

0130P01

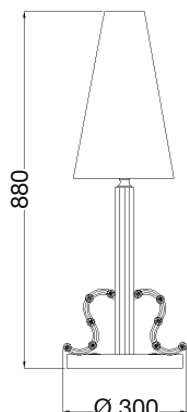

0130L01

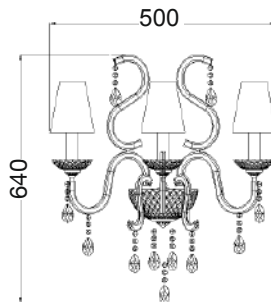

0130A01

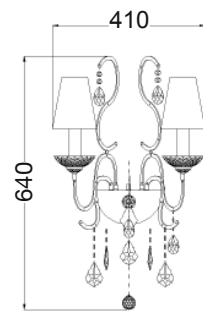

0130A02

MADemoiselle COROLLE 8000

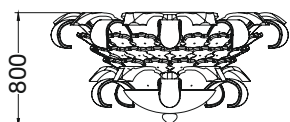

8000Q02

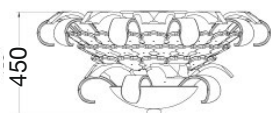

8000Q01



8010Q01



8020Q01

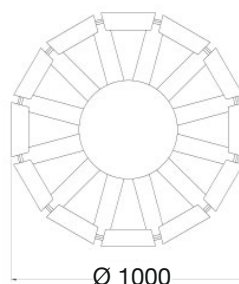
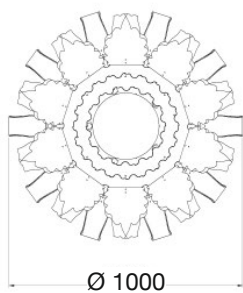
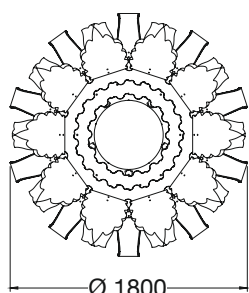

DIADEMA 5450

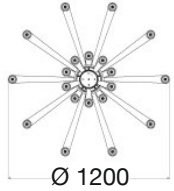
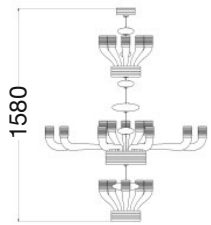

5450B01

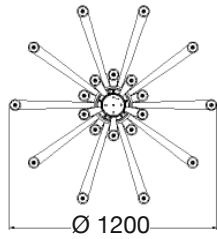
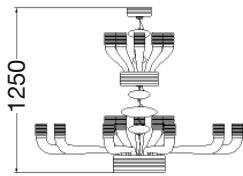

5450B06

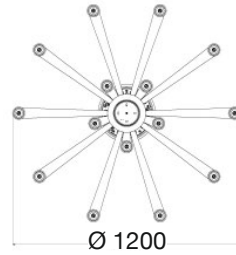
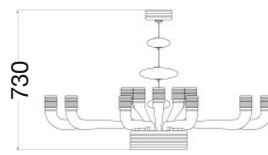

5450B07

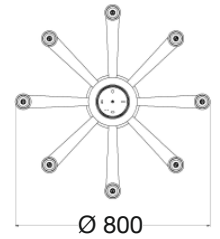
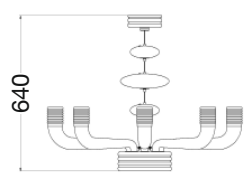

5450B02

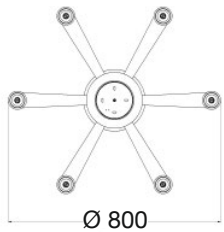
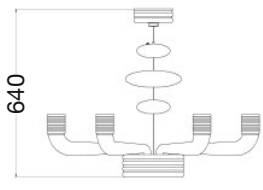

5450B08

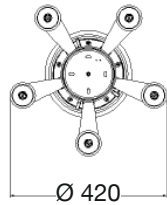
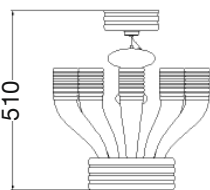

5450B09

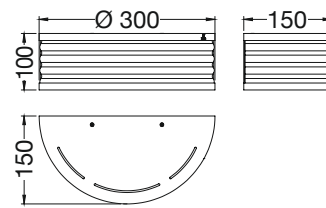

5450A01

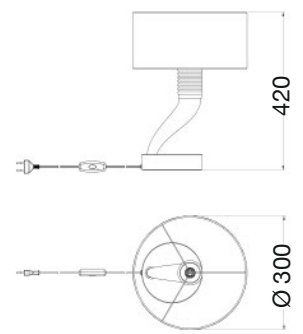

5450L03

BOUQUET 5200

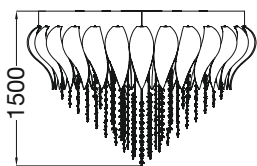
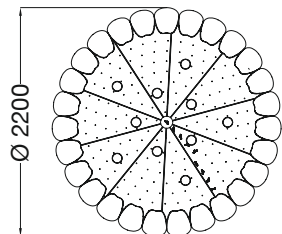

5200Q01

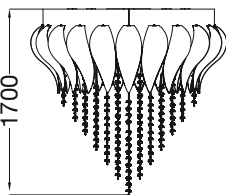
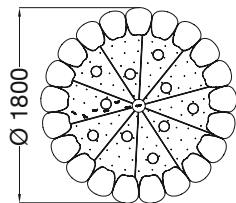

5200Q02

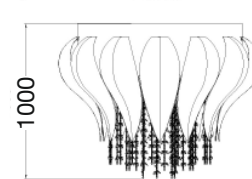
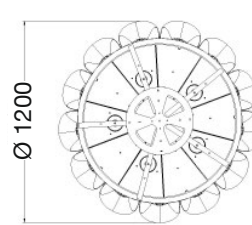

5200Q03

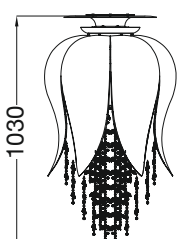
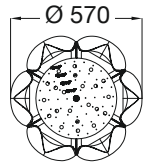

5200B11

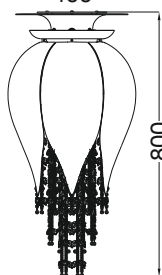

5200B10

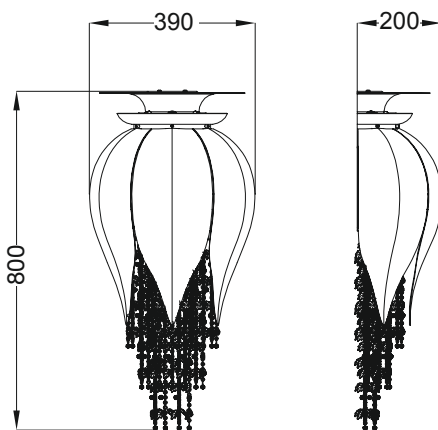

5200A04

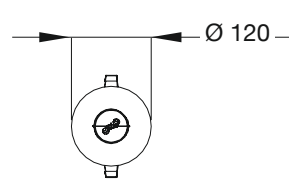

5200F01

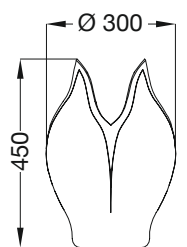

5200L01

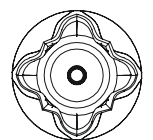

STONE 5150

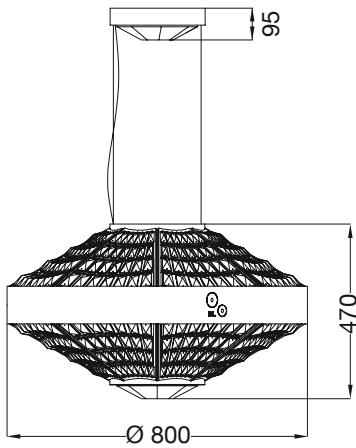

5150E01

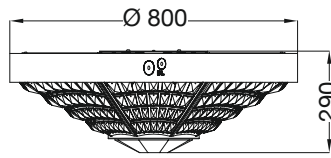

5150Q01

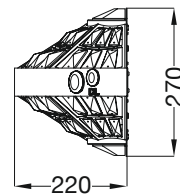

5150A02

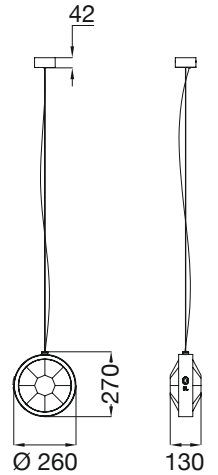

5150E03

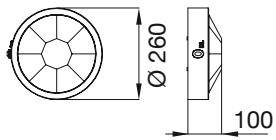

5150A01

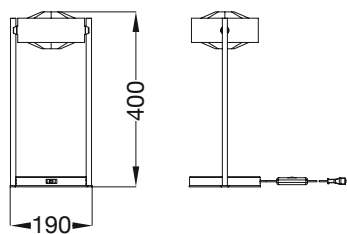

5150L02

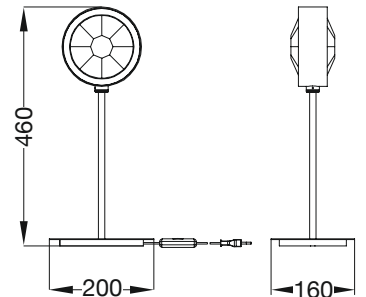

5150L03

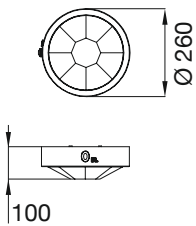

5150Q03

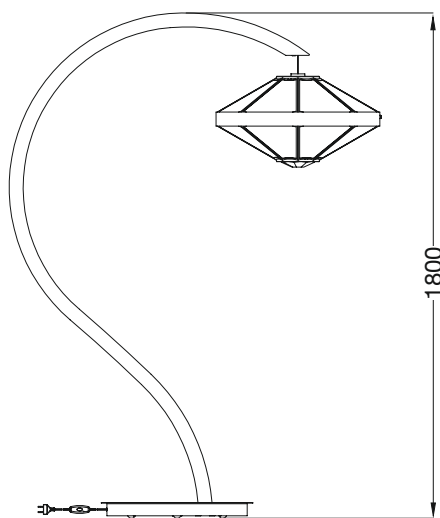

5150P01

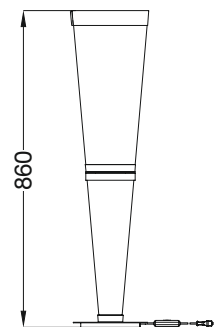

5150L01

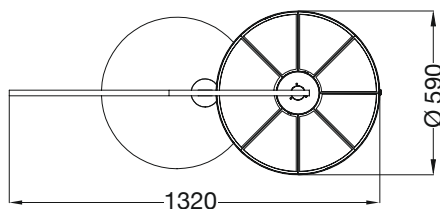

Ø 210

Tutti i prodotti **BEBY ITALY** e **DILUCE** sono costruiti, collaudati e controllati secondo le norme internazionali in vigore. In ogni nostra lampada viene applicato il tagliando di autenticità del prodotto. I colori dei vetri sono suscettibili di piccole variazioni di tonalità, data la complessa lavorazione artigianale. **BEBYGROUP SRL** si riserva di migliorare senza alcun preavviso i prodotti modificandone la componentistica.



I nuovi modelli della collezione Garden Party integrano l'esclusiva e brevettata tecnologia Be-ON: un particolare sistema di innesto delle braccia alla struttura che assicura un montaggio rapido ed una facile rimozione per la pulizia ed il mantenimento del lampadario, senza ulteriori elementi di fissaggio nè cablaggio elettrico. Tecnologia dell'eccellenza.



HIDIN': l'innovativa tecnologia brevettata che sviluppa infinite varianti di forme e colori donando un aspetto più moderno ed attuale a tutti i lampadari della collezione Privè. Una nuova idea di lampadario decorativo che ha in se tutta l'artigianalità ed il know how di un brand come BEBY ITALY.



Tutti i modelli sono registrati.



CE: Il simbolo CE "Conformité Européenne" indica che il prodotto è conforme ai requisiti essenziali di sicurezza previsti dalle direttive Europee.



Questa marcatura è utilizzata per prodotti diretti al mercato canadese e statunitense. Garantisce la conformità del prodotto ai requisiti di sicurezza canadesi e statunitensi



CLASSE I: Apparecchio nel quale la protezione contro la scossa elettrica sulle parti conduttrici accessibili, in caso di guasto, è garantita da un conduttore di messa a terra.



CLASSE II: Apparecchio nel quale la protezione contro la scossa elettrica sulle parti conduttrici accessibili, in caso di guasto, è garantita da un doppio isolamento o isolamento rinforzato.



CLASSE III: Apparecchio in cui la protezione contro la scossa elettrica si basa sull'alimentazione a bassissima tensione di sicurezza (SELV).



L'apparecchio è soggetto all'utilizzo di lampadine autoprotette.



Apparecchio soggetto alla direttiva Europea RAEE/WEEE.

BEBYGROUP SRL si riserva il diritto di mutarne le specifiche, il design o di eliminare alcuni modelli senza alcun preavviso e senza alcun obbligo.

E' vietata la riproduzione, anche parziale, di questo catalogo in qualsiasi forma e su qualsiasi supporto senza l'autorizzazione di **BEBYGROUP SRL**



UNI EN ISO 9001
CERT. N° 9105 BEBY



MADE WITH SWAROVSKI® ELEMENTS

All **BEBY ITALY** and **DILUCE** products are manufactured, checked and tested according to current international standards. All **BEBY ITALY** and **DILUCE** lighting products come with a certificate of authenticity attached. The colours of glass parts may vary slightly in shade because of the complex artisan techniques used to make them. In order to ensure the continuous improvement of its products **BEBYGROUP SRL** reserves the right to modify components without prior notice.



The latest models of the Garden Party collection incorporate the exclusive and patented Be-ON technology. A special system of engagement that ensures rapid assembly and easy removal of the arms of the structure for cleaning and maintenance without additional fixtures or electrical wiring. The technology of excellence.



BEBY ITALY's innovative and patented new HIDIN' technology creates infinite variations in form and colour and gives all the chandeliers in our Privè collection a more modern and contemporary look. This new advance in decorative chandeliers incorporates all the craftsmanship and know-how of the BEBY ITALY brand.



All models are registered.



CE: The CE (Conformité Européenne) mark signifies that a product meets the health, safety and environmental requirements established by the directives of the European Community.



This marking is used for the products of the Canadian and American markets. It guarantees the product's conformity to the Canadian and American security requirements.



CLASS I: An appliance in which protection against electric shock from accessible conductive parts in the event of a malfunction is provided by a protective earth conductor.



CLASS II: An appliance in which protection against electric shock from accessible conductive parts in the event of a malfunction is provided by double or reinforced insulation.



CLASS III: An appliance in which protection against electric shock relies in the event of a malfunction on the use of a SELV (Safety Extra-Low Voltage) power supply.



Appliances use self-protected bulbs.



Appliance conforming to the RAEE/WEEE directive of the European Community.

BEBYGROUP SRL reserves the right to modify specifications and designs and to eliminate models from its range without prior notice and without any further obligations.

Reproduction of this catalogue in part or in whole, in any way and by any means whatsoever is strictly forbidden without the prior authorisation of **BEBYGROUP SRL**



UNI EN ISO 9001
CERT. N° 9105 BEBY



MADE WITH SWAROVSKI® ELEMENTS



LIGHT&LIVING



DILUCE

LIVING DESIGN

NEW COLLECTIONS

